



# Floor Trims & Accessories

Carpet / Timber / Vinyl

Catalogue Edition 1



*The Choice of Professionals*



## ***The Choice of Professionals***

After 35 years of successfully servicing the tiling tools and accessories segment, DTA is now taking the brand into the wider flooring tools and accessories market. DTA has developed a complete range of professional and DIY carpet, laminate and vinyl floor trims and accessories. Through consultation with the trade in Australia and internationally DTA are able to offer a range of innovative trims in suitable materials, that satisfy the most demanding customer applications. DTA trims are available from retail outlets, or supplied from the state warehouses.

## TRANSITION COVER TRIMS 4

|   |   |
|---|---|
| Smooth Cover Trim                         | 5 |
| Ripple Cover Trim                         | 5 |
| Hammer Finish Cover Trim                  | 6 |
| Brush Finish Cover Trim                   | 6 |
| Adjustable Height Cover Trim              | 7 |
| Adjustable Height Cover Trim Brush Finish | 8 |
| Aluminium Ramp Transition Trim            | 8 |
| Seamless Transition Strip                 | 9 |
| Seamless Expansion Cover Strip            | 9 |

## TIMBER / LAMINATE TRIMS 10

|  |    |
|--|----|
| Concave Trim                           | 11 |
| Quadrant Trim                          | 11 |
| End Cover for Laminated/Floating Floor | 12 |
| Stair Edge Cover                       | 13 |

## CARPET TRIMS 14

|                                    |    |
|------------------------------------|----|
| Nap Lock Carpet Edge Hammer Finish | 15 |
| Nap Lock Carpet Edge Brush Finish  | 15 |

## STAIR EDGE TRIMS 16

|                               |    |
|-------------------------------|----|
| Stair Edge Trim Hammer Finish | 17 |
| Stair Edge Trim Brush Finish  | 17 |
| Stair Edge Trim               | 18 |
| Illuminated Stair Trim        | 18 |

## FLOOR FIXINGS 19

|                         |    |
|-------------------------|----|
| Carpet Gripper Strip    | 20 |
| Nails for Gripper Strip | 20 |
| Carpet Heat Seam Tape   | 21 |
| Laminate Floor Underlay | 21 |

## MERCHANDISING 22



# TRANSITION COVER TRIMS

## TRANSITION COVER TRIMS

DTA transition cover trims are designed to provide a smooth transition between two different flooring finishes. For example, carpet to tile or carpet to vinyl.

## Smooth Cover Trim

- New modern design
- Protects carpet, laminate, vinyl, timber or tile edges
- Lengths available - 1m, 1.8m and 3.3m
- Available in three anodised colours Plain, Pewter and Bright Bronze
- Screw and plug fixing

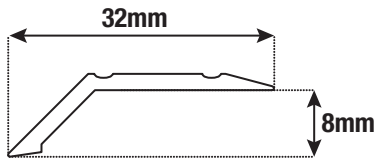

## Ripple Cover Trim

- Traditional ripple design
- Protects carpet, laminate, vinyl, timber or tile edges
- Lengths available - 1m, 1.8m and 3.3m
- Available in three anodised colours Plain, Pewter and Bright Bronze
- Nail fixing

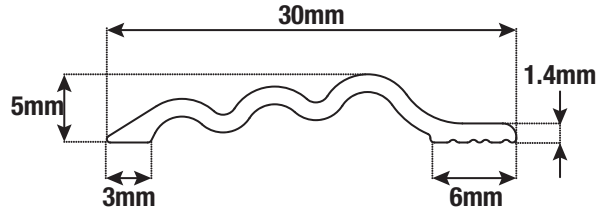

| 8mm HIGH |           | 1.0m LONG     |        |  |
|----------|-----------|---------------|--------|--|
| Colour   | Code      | Barcode       | Pk Qty |  |
|          | ACTR1.8PL | 9314942666752 | 20     |  |
|          | ACTR1.8PE | 9314942666783 | 20     |  |
|          | ACTR1.8BR | 9314942666813 | 20     |  |

| 8mm HIGH |           | 1.0m LONG     |        |  |
|----------|-----------|---------------|--------|--|
| Colour   | Code      | Barcode       | Pk Qty |  |
|          | ACER1.8PL | 9314942662372 | 20     |  |
|          | ACER1.8PE | 9314942665939 | 20     |  |
|          | ACER1.8BR | 9314942662389 | 20     |  |

| 8mm HIGH |            | 1.8m LONG     |        |  |
|----------|------------|---------------|--------|--|
| Colour   | Code       | Barcode       | Pk Qty |  |
|          | ACTR18.8PL | 9314942666769 | 20     |  |
|          | ACTR18.8PE | 9314942666790 | 20     |  |
|          | ACTR18.8BR | 9314942666820 | 20     |  |

| 8mm HIGH |            | 1.8m LONG     |        |  |
|----------|------------|---------------|--------|--|
| Colour   | Code       | Barcode       | Pk Qty |  |
|          | ACER18.8PL | 9314942662396 | 20     |  |
|          | ACER18.8PE | 9314942665946 | 20     |  |
|          | ACER18.8BR | 9314942662402 | 20     |  |

| 8mm HIGH |            | 3.3m LONG     |        |  |
|----------|------------|---------------|--------|--|
| Colour   | Code       | Barcode       | Pk Qty |  |
|          | ACTR33.8PL | 9314942666776 | 20     |  |
|          | ACTR33.8PE | 9314942666806 | 20     |  |
|          | ACTR33.8BR | 9314942666837 | 20     |  |

| 8mm HIGH |            | 3.3m LONG     |        |  |
|----------|------------|---------------|--------|--|
| Colour   | Code       | Barcode       | Pk Qty |  |
|          | ACER33.8PL | 9314942662419 | 20     |  |
|          | ACER33.8PE | 9314942665953 | 20     |  |
|          | ACER33.8BR | 9314942662426 | 20     |  |

TRANSITION COVER TRIMS



# TRANSITION COVER TRIMS

## Hammer Finish Cover Trim

- Classic hammer finish
- Protects carpet, laminate, vinyl, timber or tile edges
- Lengths available - 1m, 1.8m and 3.3m
- Available in three anodised colours Plain, Pewter and Bright Bronze
- Nail fixing

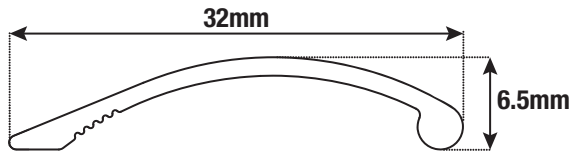

## Brush Finish Cover Trim

- Contemporary brush design
- Protects carpet, laminate, vinyl, timber or tile edges
- Lengths available - 1m, 1.8m and 3.3m
- Available in Stainless Steel and Bright Bronze
- Nail fixing

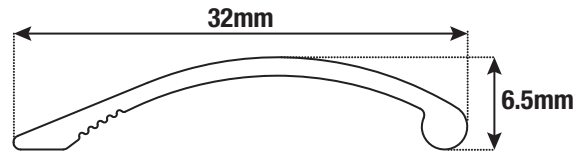

| 8mm HIGH |               | 1.0m LONG |               |    |
|----------|---------------|-----------|---------------|----|
| Colour   | Code          | Barcode   | Pk Qty        |    |
|          | Plain         | ACEC1.8PL | 9314942662433 | 20 |
|          | Pewter        | ACEC1.8PE | 9314942665960 | 20 |
|          | Bright Bronze | ACEC1.8BR | 9314942662440 | 20 |

| 8mm HIGH |                 | 1.0m LONG  |               |    |
|----------|-----------------|------------|---------------|----|
| Colour   | Code            | Barcode    | Pk Qty        |    |
|          | Stainless Steel | ACECB1.8SS | 9314942666677 | 20 |
|          | Bright Bronze   | ACECB1.8BR | 9314942667094 | 20 |

| 8mm HIGH |               | 1.8m LONG  |               |    |
|----------|---------------|------------|---------------|----|
| Colour   | Code          | Barcode    | Pk Qty        |    |
|          | Plain         | ACEC18.8PL | 9314942662457 | 20 |
|          | Pewter        | ACEC18.8PE | 9314942665977 | 20 |
|          | Bright Bronze | ACEC18.8BR | 9314942662464 | 20 |

| 8mm HIGH |                 | 1.8m LONG   |               |    |
|----------|-----------------|-------------|---------------|----|
| Colour   | Code            | Barcode     | Pk Qty        |    |
|          | Stainless Steel | ACECB18.8SS | 9314942666684 | 20 |
|          | Bright Bronze   | ACECB18.8BR | 9314942667100 | 20 |

| 8mm HIGH |               | 3.3m LONG  |               |    |
|----------|---------------|------------|---------------|----|
| Colour   | Code          | Barcode    | Pk Qty        |    |
|          | Plain         | ACEC33.8PL | 9314942662471 | 20 |
|          | Pewter        | ACEC33.8PE | 9314942665984 | 20 |
|          | Bright Bronze | ACEC33.8BR | 9314942662488 | 20 |

| 8mm HIGH |                 | 3.3m LONG   |               |    |
|----------|-----------------|-------------|---------------|----|
| Colour   | Code            | Barcode     | Pk Qty        |    |
|          | Stainless Steel | ACECB33.8SS | 9314942666691 | 20 |
|          | Bright Bronze   | ACECB33.8BR | 9314942667117 | 20 |

## Adjustable Height Cover Trim

- Ideal for use when there is a height variation up to 16mm between different floor types
- Protects timber, laminate, vinyl, carpet or tile edges
- Lengths available - 1m, 1.8m and 3.3m
- Available in Matt Silver, Brush Finish and 11 Laminate Timber Colours
- Seamless plug fixing

DIY  
TRADE  
FIXINGS  
INCLUDED

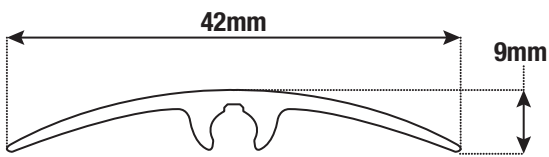

TRANSITION COVER TRIMS

| Laminate Colour | 16mm HIGH 1.0m LONG |               | 16mm HIGH 1.8m LONG |               | 16mm HIGH 3.3m LONG |               | Pk Qty |
|-----------------|---------------------|---------------|---------------------|---------------|---------------------|---------------|--------|
|                 | Code                | Barcode       | Code                | Barcode       | Code                | Barcode       |        |
| Matt Silver     | AAHC1.16MS          | 9314942662495 | AAHC18.16MS         | 9314942662518 | AAHC33.16MS         | 9314942662532 | 20     |
| Buche           | AAHC1.16W1          | 9314942662501 | AAHC18.16W1         | 9314942662525 | AAHC33.16W1         | 9314942662549 | 20     |
| Acero Bianco    | AAHC1.16W2          | 9314942665335 | AAHC18.16W2         | 9314942665250 | AAHC33.16W2         | 9314942665434 | 20     |
| Ahorn           | AAHC1.16W3          | 9314942665342 | AAHC18.16W3         | 9314942665267 | AAHC33.16W3         | 9314942665441 | 20     |
| Rovere Moke     | AAHC1.16W4          | 9314942665359 | AAHC18.16W4         | 9314942665274 | AAHC33.16W4         | 9314942665458 | 20     |
| Dark Wood       | AAHC1.16W5          | 9314942665366 | AAHC18.16W5         | 9314942665281 | AAHC33.16W5         | 9314942665465 | 20     |
| Rovere Superior | AAHC1.16W6          | 9314942665373 | AAHC18.16W6         | 9314942665298 | AAHC33.16W6         | 9314942665472 | 20     |
| Walnut          | AAHC1.16W7          | 9314942665380 | AAHC18.16W7         | 9314942665304 | AAHC33.16W7         | 9314942665489 | 20     |
| Wenge           | AAHC1.16W8          | 9314942665397 | AAHC18.16W8         | 9314942665311 | AAHC33.16W8         | 9314942665496 | 20     |
| Noce            | AAHC1.16W9          | 9314942665403 | AAHC18.16W9         | 9314942665328 | AAHC33.16W9         | 9314942665502 | 20     |
| Light Cherry    | AAHC1.16W10         | 9314942665410 | AAHC18.16W10        | 9314942665533 | AAHC33.16W10        | 9314942665519 | 20     |
| Merbau          | AAHC1.16W11         | 9314942665427 | AAHC18.16W11        | 9314942665540 | AAHC33.16W11        | 9314942665526 | 20     |



# TRANSITION COVER TRIMS

## Adjustable Height Cover Trim Brush Finish

- Ideal for use when there is a height variation up to 16mm between different floor types
- Protects timber, laminate, vinyl, carpet or tile edges
- Lengths available - 1m and 3.3m
- Available in Matt Silver, Brush Finish and 11 Laminate Timber Colours
- Seamless plug fixing

DIY  
TRADE

FIXINGS  
INCLUDED

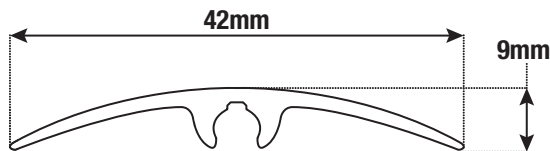

## Aluminium Ramp Transition Trim

- Allows for a gradual transition from one floor surface to a higher flooring surface
- Size available - 89mm (wide) x 12.5mm (high) x 1m or 3m (length)
- Available in Plain or Matt Silver

TRADE

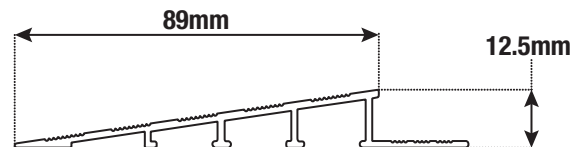

**16mm HIGH | 1.0m LONG**

| Colour | Code        | Barcode       | Pk Qty |
|--------|-------------|---------------|--------|
|        | AAHCB1.16SS | 9314942667254 | 20     |
|        | AAHCB1.16BR | 9314942667261 | 20     |

**16mm HIGH | 3.3m LONG**

| Colour | Code         | Barcode       | Pk Qty |
|--------|--------------|---------------|--------|
|        | AAHCB33.16SS | 9314942667285 | 20     |
|        | AAHCB33.16BR | 9314942667285 | 20     |

**89mm WIDE | 1.0m LONG**

| Colour | Code       | Barcode       | Pk Qty |
|--------|------------|---------------|--------|
|        | ASTE1.89   | 9314942666530 | 20     |
|        | ASTE1.89MS | 9314942666547 | 20     |

**89mm WIDE | 3.0m LONG**

| Colour | Code       | Barcode       | Pk Qty |
|--------|------------|---------------|--------|
|        | ATSE3.89   | 9314942666042 | 20     |
|        | ATSE3.89MS | 9314942666059 | 20     |



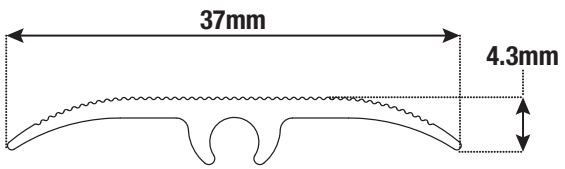

### Seamless Transition Strip

- Designed to give a seamless finish over the gap allowed for flooring expansion with a flat finish
- Protects carpet, laminate, timber or tile edges
- Size available - 37mm (wide) x 1.8m (length)
- Available in Matt Silver and Matt Bronze
- Seamless plug fixing



**33mm WIDE | 1.8m LONG**



| Colour   | Code               | Barcode       | Pk Qty |
|--|--------------------|---------------|--------|
|  Matt Silver | <b>ACCP18.33MS</b> | 9314942662556 | 5      |
|  Matt Bronze | <b>ACCP18.33MB</b> | 9314942662563 | 5      |

### Seamless Expansion Cover Strip

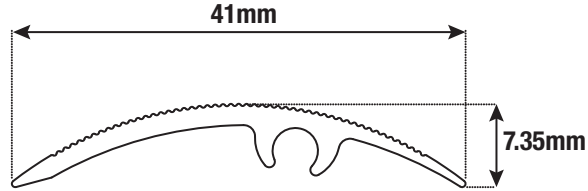
- Designed to give a seamless finish over the gap allowed for flooring expansion with a convex finish
- Protects carpet, laminate, timber or tile edges
- Size available - 41mm (wide) x 1.8m (length)
- Available in Matt Silver and Matt Bronze
- Seamless plug fixing



**41mm WIDE | 1.8m LONG**

| Colour  | Code               | Barcode       | Pk Qty |
|---|--------------------|---------------|--------|
|  Matt Silver | <b>ACRP18.41MS</b> | 9314942662570 | 5      |
|  Matt Bronze | <b>ACRP18.41MB</b> | 9314942662587 | 5      |

**TRANSITION COVER TRIMS**



# TIMBER / LAMINATE TRIMS



## TIMBER/LAMINATE TRIMS

Designed as a finishing trim, DTA stock both the scotia quadrant and concave profiles. Available in a variety of colours, you are bound to find the ideal trim for your application.

### Concave Trim

- The concave profile gives a neat finish to your flooring installation
- Easy to apply
- Lengths available - 1.8m
- Available in 12 colours
- Fix with construction adhesive or nails

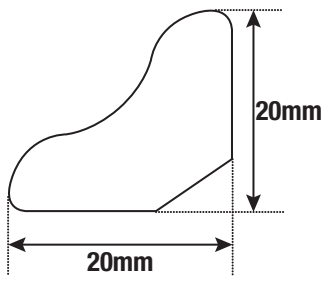

### Quadrant Trim

- The quadrant profile gives a neat finish to your flooring installation
- Easy to apply
- Lengths available - 1.8m
- Available in 12 colours
- Fix with construction adhesive or nails

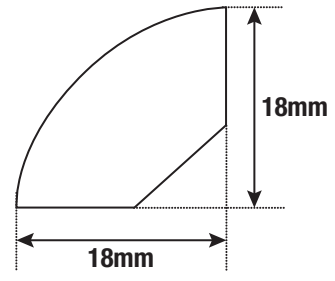

| 20mm HIGH | 20mm DEEP       | 1.8m LONG          |               |   |
|-----------|-----------------|--------------------|---------------|---|
| Colour    | Code            | Barcode            | Pk Qty        |   |
|           | Buche           | <b>TTC18.28W1</b>  | 9314942663980 | 5 |
|           | Acero Bianco    | <b>TTC18.28W2</b>  | 9314942665557 | 5 |
|           | Ahorn           | <b>TTC18.28W3</b>  | 9314942665564 | 5 |
|           | Rovere Moke     | <b>TTC18.28W4</b>  | 9314942665571 | 5 |
|           | Dark Wood       | <b>TTC18.28W5</b>  | 9314942665588 | 5 |
|           | Rovere Superior | <b>TTC18.28W6</b>  | 9314942665595 | 5 |
|           | Walnut          | <b>TTC18.28W7</b>  | 9314942665601 | 5 |
|           | Wenge           | <b>TTC18.28W8</b>  | 9314942665618 | 5 |
|           | Noce            | <b>TTC18.28W9</b>  | 9314942665625 | 5 |
|           | Light Cherry    | <b>TTC18.28W10</b> | 9314942665632 | 5 |
|           | Merbau          | <b>TTC18.28W11</b> | 9314942665649 | 6 |

| 18mm HIGH | 18mm DEEP       | 1.8m LONG          |               |   |
|-----------|-----------------|--------------------|---------------|---|
| Colour    | Code            | Barcode            | Pk Qty        |   |
|           | Buche           | <b>TTQ18.28W1</b>  | 9314942665755 | 5 |
|           | Acero Bianco    | <b>TTQ18.28W2</b>  | 9314942665656 | 5 |
|           | Ahorn           | <b>TTQ18.28W3</b>  | 9314942665663 | 5 |
|           | Rovere Moke     | <b>TTQ18.28W4</b>  | 9314942665670 | 5 |
|           | Dark Wood       | <b>TTQ18.28W5</b>  | 9314942665687 | 5 |
|           | Rovere Superior | <b>TTQ18.28W6</b>  | 9314942665694 | 5 |
|           | Walnut          | <b>TTQ18.28W7</b>  | 9314942665700 | 5 |
|           | Wenge           | <b>TTQ18.28W8</b>  | 9314942665717 | 5 |
|           | Noce            | <b>TTQ18.28W9</b>  | 9314942665724 | 5 |
|           | Light Cherry    | <b>TTQ18.28W10</b> | 9314942665731 | 5 |
|           | Merbau          | <b>TTQ18.28W11</b> | 9314942665748 | 6 |

TIMBER / LAMINATE TRIMS



## End Cover for Laminated/Floating Floor

- To provide protection to raw laminate edges giving a professional clean finish
- Allows for neat transition between laminate and carpet
- Size available - 8mm, 13mm and 15mm (height) x 1.8m (length)
- Available in Matt Silver and Matt Bronze

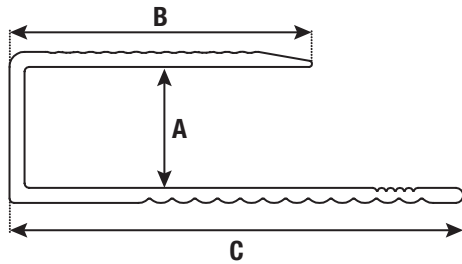

| Size A | B    | C    |
|--------|------|------|
| 8mm    | 18mm | 25mm |
| 13mm   | 18mm | 25mm |
| 15mm   | 18mm | 25mm |

| Colour | 8mm HIGH   1.8m LONG |            | 8mm HIGH   3.3m LONG |             | Pk Qty        |    |
|--------|----------------------|------------|----------------------|-------------|---------------|----|
|        | Code                 | Barcode    | Code                 | Barcode     |               |    |
|        | Matt Silver          | LFEC18.8MS | 9314942663355        | LFEC33.08MS | 9314942667315 | 20 |
|        | Matt Bronze          | LFEC18.8MB | 9314942663362        | LFEC33.08MB | 9314942667322 | 20 |

| Colour | 13mm HIGH   1.8m LONG |             | 13mm HIGH   3.3m LONG |             | Pk Qty        |    |
|--------|-----------------------|-------------|-----------------------|-------------|---------------|----|
|        | Code                  | Barcode     | Code                  | Barcode     |               |    |
|        | Matt Silver           | LFEC18.13MS | 9314942663263         | LFEC33.13MS | 9314942667339 | 20 |
|        | Matt Bronze           | LFEC18.13MB | 9314942663270         | LFEC33.13MB | 9314942667346 | 20 |

| Colour | 15mm HIGH   1.8m LONG |             | 15mm HIGH   3.3m LONG |             | Pk Qty        |    |
|--------|-----------------------|-------------|-----------------------|-------------|---------------|----|
|        | Code                  | Barcode     | Code                  | Barcode     |               |    |
|        | Matt Silver           | LFEC18.15MS | 9314942663294         | LFEC33.15MS | 9314942667353 | 20 |
|        | Matt Bronze           | LFEC18.15MB | 9314942663300         | LFEC33.15MB | 9314942667360 | 20 |

## Stair Edge Cover



- Designed to provide protection to raw laminate/floating floor edges on stairs, giving a professional clean finish
- Enables easy installation of laminate or floating floors to stair cases
- Size available - 8mm and 15mm (height) x 1.8m (length)
- Available in Matt Silver and Matt Bronze

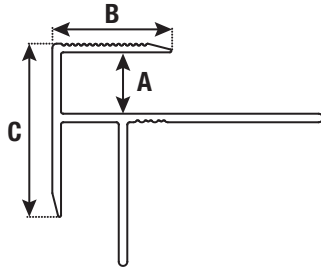

| Size A | B      | C    |
|--------|--------|------|
| 8mm    | 16.5mm | 24mm |
| 15mm   | 16.5mm | 31mm |



| Colour | 8mm HIGH   1.8m LONG |             | 15mm HIGH   3.3m LONG |             | Pk Qty        |   |
|--------|----------------------|-------------|-----------------------|-------------|---------------|---|
|        | Code                 | Barcode     | Code                  | Barcode     |               |   |
|        | Matt Silver          | LFEE18.08MS | 9314942662693         | LFEE18.15MS | 9314942662716 | 5 |
|        | Matt Bronze          | LFEE18.08MB | 9314942662709         | LFEE18.15MB | 9314942662723 | 5 |

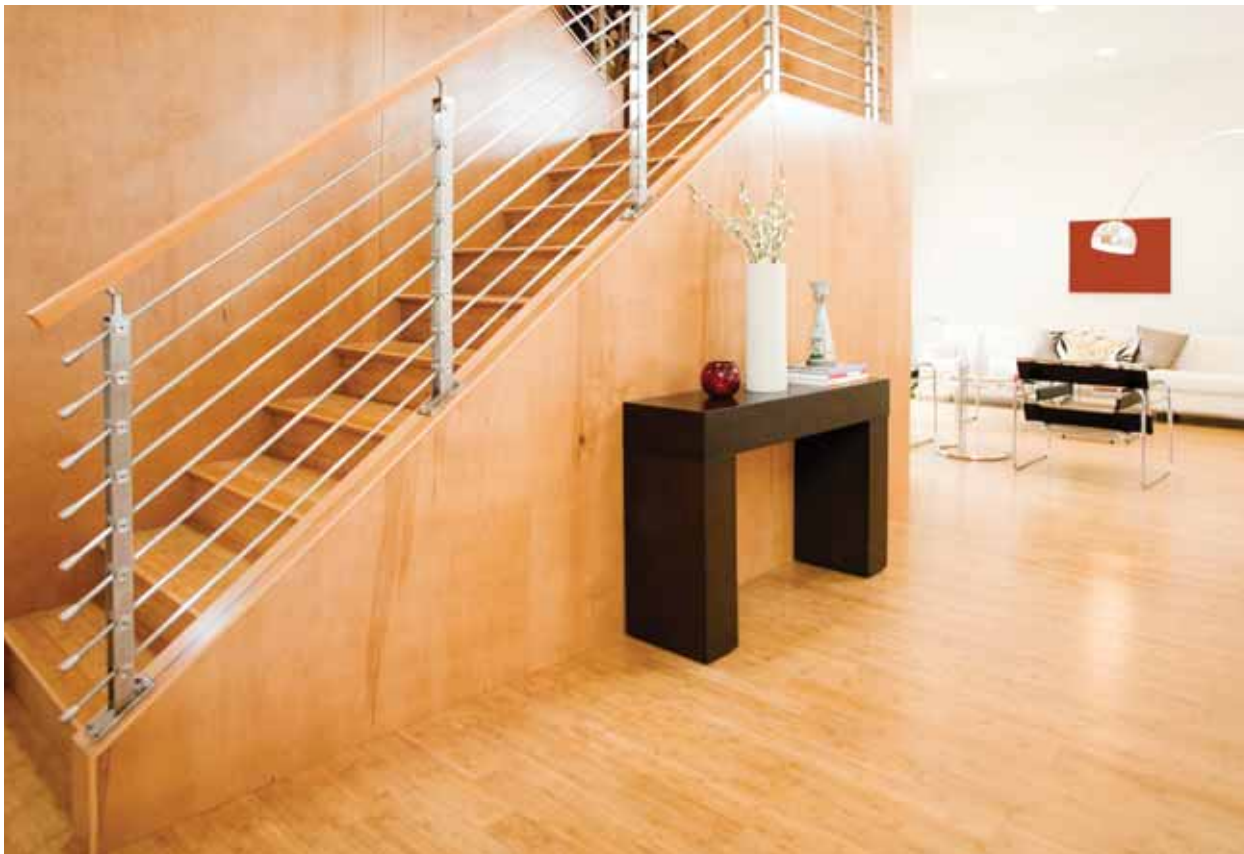

TIMBER / LAMINATE TRIMS



# CARPET TRIMS

## CARPET TRIMS

The DTA range of heavy duty carpet trims are used predominantly in door jambs and larger open areas to secure carpet edges directly to the floor giving a complete professional finish.

### Nap Lock Carpet Edge Hammer Finish

- Hammer finish would be suited to your more traditional design
- Easily installed with use of a DTA White Rubber Mallet
- Lengths available - 1m, 1.8m and 3.3m
- Available in Plain, Pewter and Bright Bronze

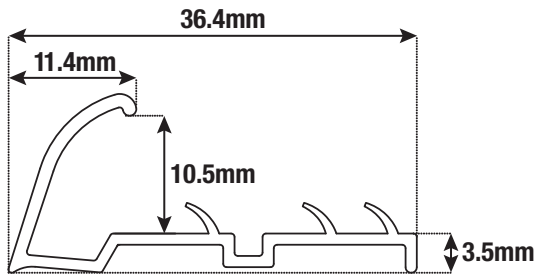

### Nap Lock Carpet Edge Brush Finish

- Brush finish would be suited to your more modern/contemporary design
- Easily installed with use of a DTA White Rubber Mallet
- Lengths available - 1m, 1.8m and 3.3m
- Available in Stainless Steel and Bright Bronze

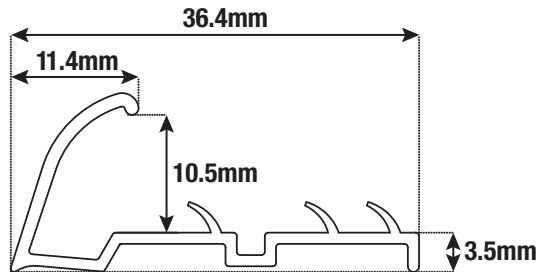

| 1.0m LONG |               |                   |               |        |
|-----------|---------------|-------------------|---------------|--------|
| Colour    |               | Code              | Barcode       | Pk Qty |
|           | Plain         | <b>ACEH1.10PL</b> | 9314942665151 | 5      |
|           | Pewter        | <b>ACEH1.10PE</b> | 9314942666011 | 5      |
|           | Bright Bronze | <b>ACEH1.10BR</b> | 9314942665168 | 5      |

| 1.0m LONG |                 |                   |               |        |
|-----------|-----------------|-------------------|---------------|--------|
| Colour    |                 | Code              | Barcode       | Pk Qty |
|           | Stainless Steel | <b>ACEB1.10SS</b> | 9314942666707 | 5      |
|           | Bright Bronze   | <b>ACEB1.10BR</b> | 9314942667148 | 5      |

| 1.8m LONG |               |                    |               |        |
|-----------|---------------|--------------------|---------------|--------|
| Colour    |               | Code               | Barcode       | Pk Qty |
|           | Plain         | <b>ACEH18.10PL</b> | 9314942665175 | 5      |
|           | Pewter        | <b>ACEH18.10PE</b> | 9314942666028 | 5      |
|           | Bright Bronze | <b>ACEH18.10BR</b> | 9314942665182 | 5      |

| 1.8m LONG |                 |                    |               |        |
|-----------|-----------------|--------------------|---------------|--------|
| Colour    |                 | Code               | Barcode       | Pk Qty |
|           | Stainless Steel | <b>ACEB18.10SS</b> | 9314942666714 | 5      |
|           | Bright Bronze   | <b>ACEB18.10BR</b> | 9314942667155 | 5      |

| 3.3m LONG |               |                    |               |        |
|-----------|---------------|--------------------|---------------|--------|
| Colour    |               | Code               | Barcode       | Pk Qty |
|           | Plain         | <b>ACEH33.10PL</b> | 9314942665199 | 5      |
|           | Pewter        | <b>ACEH33.10PE</b> | 9314942666035 | 5      |
|           | Bright Bronze | <b>ACEH33.10BR</b> | 9314942665205 | 5      |

| 3.3m LONG |                 |                    |               |        |
|-----------|-----------------|--------------------|---------------|--------|
| Colour    |                 | Code               | Barcode       | Pk Qty |
|           | Stainless Steel | <b>ACEB33.10SS</b> | 9314942666721 | 5      |
|           | Bright Bronze   | <b>ACEB33.10BR</b> | 9314942667162 | 5      |

CARPET TRIMS



# STAIR EDGE TRIMS



## STAIR EDGE TRIMS

DTA stair edge trims are designed for the protection of stair edges in both the residential and commercial markets. Easily applied over carpet, timber, tile or vinyl.



### Stair Edge Trim Hammer Finish

- Ideal protection for stairs
- Protects carpet, vinyl, timber or tile edges
- Lengths available - 1m or 3m
- Hammer Finish available in Plain, Pewter and Bright Bronze
- Nail fixing



### Stair Edge Trim Brush Finish

- Ideal protection for stairs
- Protects carpet, vinyl, timber or tile edges
- Lengths available - 1m or 3m
- Brush Finish available in Stainless Steel and Bright Bronze
- Nail fixing

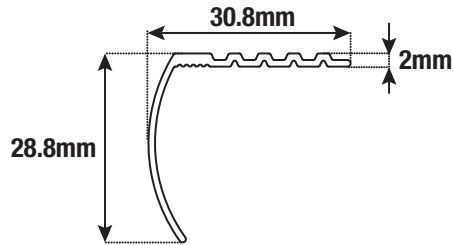
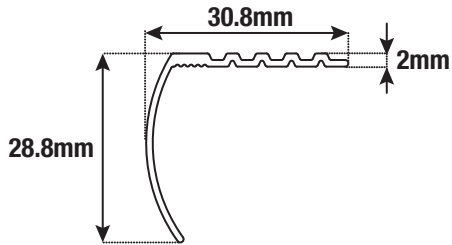

#### 1.0m LONG

| Colour        | Code               | Barcode       | Pk Qty |
|---------------|--------------------|---------------|--------|
| Plain         | <b>ASTRH1.27PL</b> | 9314942662594 | 20     |
| Pewter        | <b>ASTRH1.27PE</b> | 9314942665991 | 20     |
| Bright Bronze | <b>ASTRH1.27BR</b> | 9314942662600 | 20     |

#### 1.0m LONG

| Colour          | Code               | Barcode       | Pk Qty |
|-----------------|--------------------|---------------|--------|
| Stainless Steel | <b>ASTRB1.27SS</b> | 9314942666738 | 20     |
| Bright Bronze   | <b>ASTRB1.27BR</b> | 9314942667124 | 20     |

#### 3.0m LONG

| Colour        | Code               | Barcode       | Pk Qty |
|---------------|--------------------|---------------|--------|
| Plain         | <b>ASTRH3.27PL</b> | 9314942662617 | 20     |
| Pewter        | <b>ASTRH3.27PE</b> | 9314942666004 | 20     |
| Bright Bronze | <b>ASTRH3.27BR</b> | 9314942662624 | 20     |

#### 3.0m LONG

| Colour          | Code               | Barcode       | Pk Qty |
|-----------------|--------------------|---------------|--------|
| Stainless Steel | <b>ASTRB3.27SS</b> | 9314942666745 | 20     |
| Bright Bronze   | <b>ASTRB3.27BR</b> | 9314942667131 | 20     |

STAIR EDGE TRIMS



# STAIR EDGE TRIMS

## Stair Edge Trim

- Perfect for the protection of stairs
- 50mm tread to protect the carpet, vinyl, timber or tile edges
- Lengths available - 1m or 3m
- Available in Plain (mill finish)
- Screw and plug fixing

DIY  
TRADE

FIXINGS  
INCLUDED

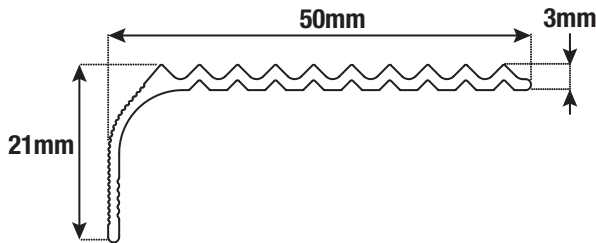

### 1.0m LONG

| Colour | Code              | Barcode       | Pk Qty |
|--------|-------------------|---------------|--------|
| Plain  | <b>ASTR50.1PL</b> | 9314942662631 | 5      |

### 3.0m LONG

| Colour | Code              | Barcode       | Pk Qty |
|--------|-------------------|---------------|--------|
| Plain  | <b>ASTR50.3PL</b> | 9314942662655 | 5      |

## Illuminated Stair Trim

- High strength aluminium
- Anti-slip tread pattern
- Illumination strip for safety once lights have been turned off
- UV stable
- Lengths available - 1m or 3m
- Adhesive fixing

DIY  
TRADE

FIXINGS  
INCLUDED

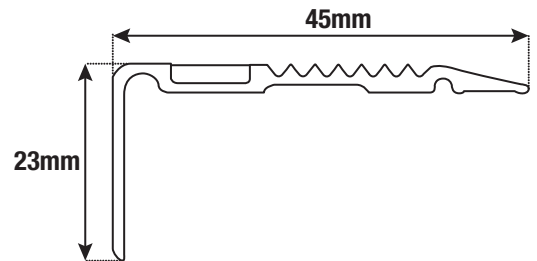

### 1.0m LONG

| Colour      | Code               | Barcode       | Pk Qty |
|-------------|--------------------|---------------|--------|
| Matt Silver | <b>AST1.45MSAI</b> | 9314942665908 | 10     |

### 3.0m LONG

| Colour      | Code               | Barcode       | Pk Qty |
|-------------|--------------------|---------------|--------|
| Matt Silver | <b>AST3.45MSAI</b> | 9314942667438 | 10     |



# FLOOR FIXINGS

## FLOOR FIXINGS

To complete the range of Floor Trims and Accessories DTA offer “Get a Grip with DTA” Carpet Gripper, laminate floor underlay, dual purpose nails, cement sheet nails, seam tapes, carpet and hard floor protection. DTA also offer a comprehensive range of flooring installation tools to complete your project.



## Carpet Gripper Strip

### Dual Nail Strip

- Ideal for either concrete or timber applications
- 25mm available in packet of 5 or carton of 100
- 32mm available in packet of 5 or carton of 100

### Concrete Nail Strip

- Designed for concrete applications
- Available in 25mm x carton of 100 or 32mm x carton of 70

### Timber Nail Strip

- Designed for timber applications
- Available in 25mm x carton of 100 or 32mm x carton of 70

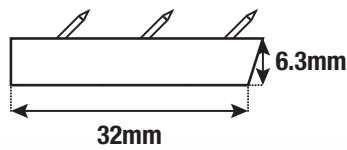
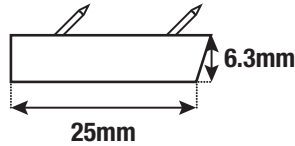

| DIY/TRADE |               | 25mm WIDE | 1.2m LONG |        |  |
|-----------|---------------|-----------|-----------|--------|--|
| Code      | Barcode       | Fixings   | Pieces    | Pk Qty |  |
| CGS5.25   | 9314942665014 | Dual Nail | 5         | 20     |  |
| CGS100.25 | 9314942665021 | Dual Nail | 100       | 1      |  |

| TRADE      |               | 25mm WIDE     | 1.2m LONG |        |  |
|------------|---------------|---------------|-----------|--------|--|
| Code       | Barcode       | Fixings       | Pieces    | Pk Qty |  |
| CGS100.25C | 9314942666851 | Concrete Nail | 100       | 1      |  |
| CGS100.25T | 9314942666868 | Timber Nail   | 100       | 1      |  |

| DIY/TRADE |               | 32mm WIDE | 1.2m LONG |        |  |
|-----------|---------------|-----------|-----------|--------|--|
| Code      | Barcode       | Fixings   | Pieces    | Pk Qty |  |
| CGS5.32   | 9314942665038 | Dual Nail | 5         | 5      |  |
| CGS70.32  | 9314942665045 | Dual Nail | 70        | 5      |  |

| TRADE     |               | 32mm WIDE     | 1.2m LONG |        |  |
|-----------|---------------|---------------|-----------|--------|--|
| Code      | Barcode       | Fixings       | Pieces    | Pk Qty |  |
| CGS70.32C | 9314942666875 | Concrete Nail | 70        | 1      |  |
| CGS70.32T | 9314942666882 | Timber Nail   | 70        | 1      |  |

## Nails for Gripper Strip



- Ideal for carpet gripper
- DTA Heavy Duty Concrete Nails are available in 16mm x 500g or 1kg
- DTA Dual Purpose Timber Nails are available in 18mm x 500g and 1kg

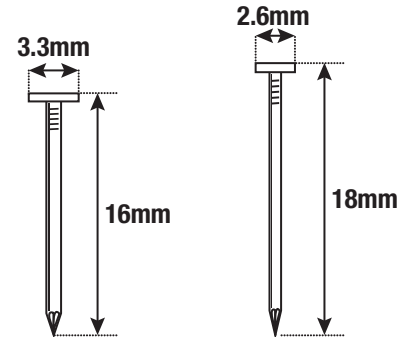

| Heavy Duty Concrete Nails |               | 3.3mm WIDE | 16mm LONG |  |  |
|---------------------------|---------------|------------|-----------|--|--|
| Code                      | Barcode       | Size       | Pk Qty    |  |  |
| CGNC500.16                | 9314942665052 | 500g       | 5         |  |  |
| CGNC1.16                  | 9314942665069 | 1kg        | 5         |  |  |

| Dual Purpose Timber & Concrete Nails |               | 2.6mm WIDE | 18mm LONG |  |  |
|--------------------------------------|---------------|------------|-----------|--|--|
| Code                                 | Barcode       | Size       | Pk Qty    |  |  |
| CGNDP500.18                          | 9314942665076 | 500g       | 5         |  |  |
| CGNDP1.18                            | 9314942665083 | 1kg        | 5         |  |  |

## Carpet Heat Seam Tape

- The knitted backing pad will not stick to the underlay
- It has fibreglass reinforcement giving it a stronger bonding strength
- Available in 20 metre rolls in three widths 88mm, 105mm and 150mm

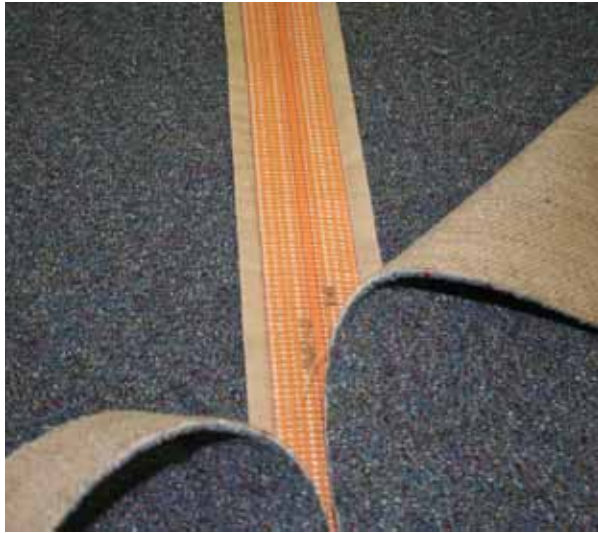

## Laminate Floor Underlay



- Foam 2mm underlay
- Noise reducing
- Built in moisture barrier
- Flexible for easy installation
- Features overlapping moisture barrier film



| Code      | Barcode       | Size       | Pk Qty |
|-----------|---------------|------------|--------|
| CHST20.88 | 9314942665106 | 88mm x 20m | 1      |



| Code       | Barcode       | Size        | Pk Qty |
|------------|---------------|-------------|--------|
| CHST20.105 | 9314942665120 | 105mm x 20m | 1      |
| CHST20.150 | 9314942665144 | 150mm x 20m | 1      |

| Code  | Barcode       | Size            | Pk Qty |
|-------|---------------|-----------------|--------|
| UN2MM | 9314942667292 | 1.2m x 50m Roll | 1      |





# MERCHANDISING



## MERCHANDISING

To help you sell DTA, the strongest brand in the tiling tools and accessories market, we have a range of merchandising materials and modular stands. These help increase customer purchases and brand awareness. Call our customer service representatives to help you choose the products that will increase your DTA sales.

## Tool Merchandising Stand

### DIMENSIONS - 1m(W) x 2m(H)

- Neatly and conveniently displays tools in stores
- Can be individually tailored to suit store requirements
- Illuminated header sign



| Product                               | Code   | Pk Qty |
|---------------------------------------|--------|--------|
| Tool Stand                            | DTATD  | 1      |
| Basket for Tools                      | DTATDB | 1      |
| Shelf for Stand                       | DTATDS | 1      |
| 150mm Peg Board Hook with Flipper Tag | PHB150 | 1      |
| 250mm Peg Board Hook with Flipper Tag | PBH250 | 1      |

## Trim Merchandising Stand

### DIMENSIONS - 1m(W) x 2m(H)

- Neatly and efficiently displays PVC and metal trims in stores
- Can be individually tailored to suit store requirements
- Illuminated header sign



| Product                 | Code    | Pk Qty |
|-------------------------|---------|--------|
| Trim Stand              | DTATD   | 1      |
| Hanging Hooks for Trims | DTATDH  | 1      |
| Trim Divider Brackets   | DTATDHT | 1      |

## 1 metre Tool and Trim Stand

### DIMENSIONS - 1m(W) x 1.2m(H)

- Neatly and conveniently displays tile cutters in stores
- Can be individually tailored to suit store requirements
- Illuminated header sign

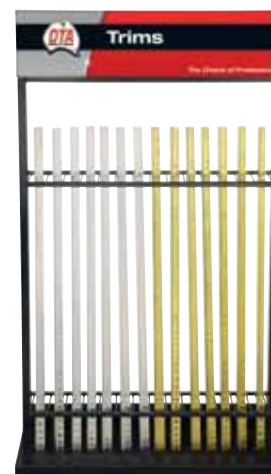

| Product                               | Code    | Pk Qty |
|---------------------------------------|---------|--------|
| 1m Tool and Trim Stand                | DTATD1M | 1      |
| Hanging Hooks for Trims               | DTATDH  | 1      |
| Basket for Tools                      | DTATDB  | 1      |
| Trim Divider Brackets                 | DTATDHT | 1      |
| Shelf for 1m Stand                    | DTATDS  | 1      |
| 50mm Peg Board Hook with Flipper Tag  | PHB150  | 1      |
| 250mm Peg Board Hook with Flipper Tag | PBH250  | 1      |



[www.dta-aus.com.au](http://www.dta-aus.com.au)

*The Choice of Professionals*

### **Head Office – VICTORIA**

ABN 26 007 291 054

P 1800 505 045

F 03 9781 9788

E [sales@dta-aus.com.au](mailto:sales@dta-aus.com.au)

P.O. Box 318, Patterson Lakes 3197

6 Ashley Park Drive, Chelsea Heights 3196

### **NEW SOUTH WALES**

P 1800 505 045

F 1800 834 200

E [sales@dta-aus.com.au](mailto:sales@dta-aus.com.au)

38 Mount Erin Road, Campbelltown 2560

### **WESTERN AUSTRALIA**

P 08 9475 0633

F 08 9475 0644

E [dtawa@dta-aus.com.au](mailto:dtawa@dta-aus.com.au)

Unit 4/130 Francisco Street, Belmont 6104

### **QUEENSLAND**

P 1800 505 045

F 07 3883 6066

E [dtaqld@dta-aus.com.au](mailto:dtaqld@dta-aus.com.au)

7 Hinkler Court, Brendale 4500

### **SOUTH AUSTRALIA**

P 1800 505 045

F 03 9781 9788

E [sales@dta-aus.com.au](mailto:sales@dta-aus.com.au)

### **CHINA**

E [sales@dta-aus.com.au](mailto:sales@dta-aus.com.au)

No. 518 Guang Le Road,

Guang Ming Industrial Area, Nan Qiao Town,

Fengxian District, Shanghai China

DTA reserve the right to change product specifications without notice. Products may vary from pictures shown.

Colours shown are as close as possible to actual trim colours.

Please note: due to limitations of the printing process, printed colours may not represent the true colour.