

**Platinum[®]
Suite**
**The equilibrium
of strength
and design**

Platinum[®] Suite

The Platinum suite offers a broad range of wall partition suite options with aluminium glazing frames for doors and windows. There are four systems available in the Platinum suite which are universal and can be used together in the one office fit-out. This interchangeability offers great flexibility for your office design, while a uniform 35mm reveal presents a distinct, streamlined finish and a professional result within any building.

The doors and windows in this suite are held by aluminium frames that also boast an innovative door jamb, setting it apart from other designs. The choice of colours available for the glass window frames is extensive, with a range of anodising or powder coat finishes. Frames can be fabricated and painted onsite or, if you prefer, you can select your colour and finish before construction and have it delivered to you, ready to build.

The Platinum suite incorporates a heavy-duty door frame with the three-point fixing design. This further contributes to the system's strength and rigidity. This suite has been used in many projects throughout Australia because of its ability to work with any architect's design or vision. Its versatile character allows the Platinum suite to be readily used in both industrial and residential applications.



Platinum 90

The equilibrium of strength and design.

The Platinum 90 suite incorporates 64mm studs with 13mm plasterboard. This popular suite offers three glazing options; centre glazed, offset glazed and double glazed. Whilst centre glazed is most commonly used, the offset glazed option creates an expansive sensation, and provides practical benefits such as the ability to incorporate blinds within the frame to increase privacy. All three glazing options are

interchangeable. Double glazing provides additional acoustic benefits, and has proved to be a very popular option in locations where sound reduction is important. Executive office suites and windows into the warehouse are two zones where sound reduction is a priority.

Features of the Platinum 90

- Offers acoustic performance
- Estimated sound rating for solid plasterboard walls:
 - RW 35 (without insulation)
 - RW 40 (with CAB3 Polyester Insulation)
- Provides two plasterboard options:
 - 1) 64mm studs with a single skin of 13mm plasterboard on either side of the stud, or
 - 2) 51mm studs with a double skin of 13mm plasterboard on one side of the stud and a single

- skin on the other
- Glazing pocket incorporates 6mm to 10mm glass
- Door Stop options allow for 35mm, 38mm or 44mm doors
- Glazing pocket accepts either a captive wedge or silicone glazing options
- Window/Door frames and Ceiling Channel accommodates gussets providing enhanced joining capabilities





Platinum 105

The equilibrium of strength and design.

The Platinum 105 suite incorporates 76mm studs with 13mm plasterboard. This suite allows for a combination of plasterboard skins, enhancing the acoustic capacity of the wall.

Its ability to incorporate 76mm steel or metal studs provides extra scope for load bearing capabilities.

With the crisp Platinum 35mm reveal, the 105 suite can be used in combination with any of the other Platinum suites.

Features of the Platinum 105

- Provides three plasterboard options:
 - 1) 76mm studs with a single skin of 13mm plasterboard on either side of the stud,
 - 2) 64mm studs with a double skin of 13mm plasterboard on one side of the stud and a single skin on the other, or
 - 3) 51mm studs with a double skin of 13mm plasterboard on either side of the stud
- Glazing pocket incorporates 6mm to 10mm glass

- Door Stop options allow for 35mm, 38mm or 44mm doors
- Glazing pocket accepts either a captive wedge or silicone glazing options
- Window/Door frames and Ceiling Channel accommodates gussets providing enhanced joining capabilities

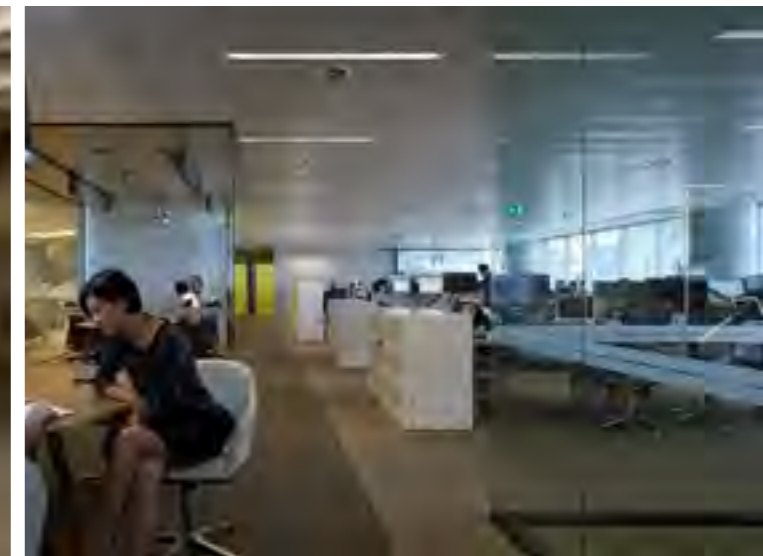



Platinum 110

The equilibrium of strength and design.

The Platinum 110 incorporates 92mm studs with 10mm plasterboard. Our latest addition to the series, boasts an innovative door jamb that sets it apart from traditional methods. Designed to be used residentially or commercially, the 110 frame is an all-purpose solution.

The 110 specifically focuses on door and window framing that displays a slim-line finish which is both visually appealing and

robust. Door and window frame fabrication can simply be done on site or prior to delivery.

A unique feature of this suite is the heavy duty door stop, which incorporates either 38mm or 44mm doors.

The aluminium can be finished in a variety of anodising or powder coat colours, eliminating the need for the frames to be painted on site.

Features of the Platinum 110

- Suits both 92mm steel studs or 90mm timber studs with 10mm plasterboard
- Allows structural columns and plumbing to be incorporated within the cavity
- Door Stop options allow for 35mm or 44mm doors also with the option of the heavy duty Door Stop which suits 38mm or 44mm doors
- Glazing pocket incorporates 6mm to 10mm glass





Platinum 120

The equilibrium of strength and design.

The Platinum 120 Suite incorporates 92mm steel studs or 90mm timber studs with 13mm plasterboard on either side.

This versatile suite offers three glazing options; centre glazed, offset glazed and double glazed. The double glazed option is often used in areas where acoustics are paramount

Features of the Platinum 120

- Estimated sound rating of:
 - RW 36 (without insulation)
 - RW 42 (with CAB4 Polyester Insulation)(Figures are based on single layers of plasterboard; increase of layers will in turn boost the rating)
- Provides the maximum variety of plasterboard options;
 - 1) 92mm studs with a single skin of 13mm plasterboard on either side of the stud,
 - 2) 76mm studs with a double

- skin of 13mm plasterboard on one side of the stud and a single skin on the other, or
- 3) 64mm studs with a double skin of 13mm plasterboard on either side of the stud
- Glazing pocket incorporates 6mm to 10mm glass
- Door Stop options allow for 35mm or 44mm doors
- Glazing pocket accepts either a captive wedge or silicone glazing options
- Incorporates the Artesian Cavity Unit



Platinum 90

To suit 64mm Studs

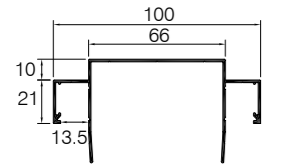

Ceiling Channel
(10mm shadowline)
CI-2211
(CI-6401)

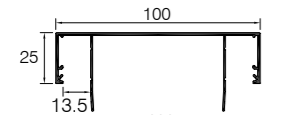

Ceiling Channel
(No shadowline)
CI-2410

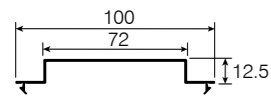

Shadowline
Adaptor
CI-2215

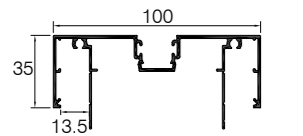

Door Frame
CI-2220
(CI-6402)

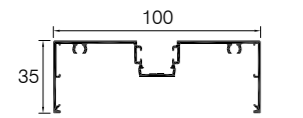

Window Frame
CI-2230
(CI-6403)

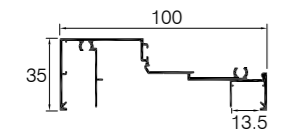

Window Sill
CI-2250
(CI-6405)

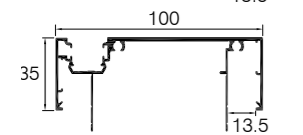

Offset Frame
CI-2233
(CI-6432)

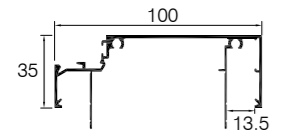

Offset Sill
CI-2253
(CI-6435)

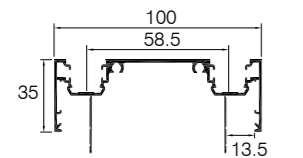

Double Glazing
Frame
CI-2232
(CI-6442)

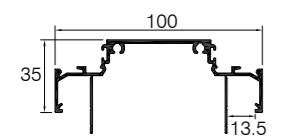

Double Glazing Sill
CI-2252
(CI-6445)

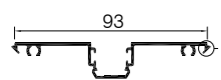

Glazing Adaptor
CI-2240
(CI-6404)

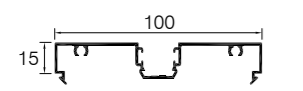

Frame Adaptor
(15mm reveal)
CI-2241
(CI-6420)

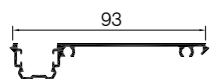

Offset Glazing Adaptor
CI-2243
(CI-6434)

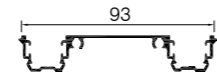

Double Glazing Adaptor
CI-2242
(CI-6444)

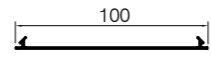

Flat Filler
CI-2244
(CI-6413)



Offset and Double Glaze Sill
Bead
CI-4256
(CI-9236)

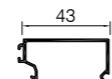

Sill Bead to suit CI-2250
CI-2251
(CI-6406)

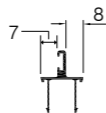

Door Stop (44mm doors)
CI-2263
(CI-6407)



Door Stop (35mm doors)
CI-2261
(CI-6408)



Pocket Filler
CI-4260
(CI-9209)

Platinum 90

To suit 64mm Studs

Platinum Joining Stake Provision



Channel Bracket - Fixing solution when using 25 x 25 glazing channel on horizontals



Offset Glazing Elevation

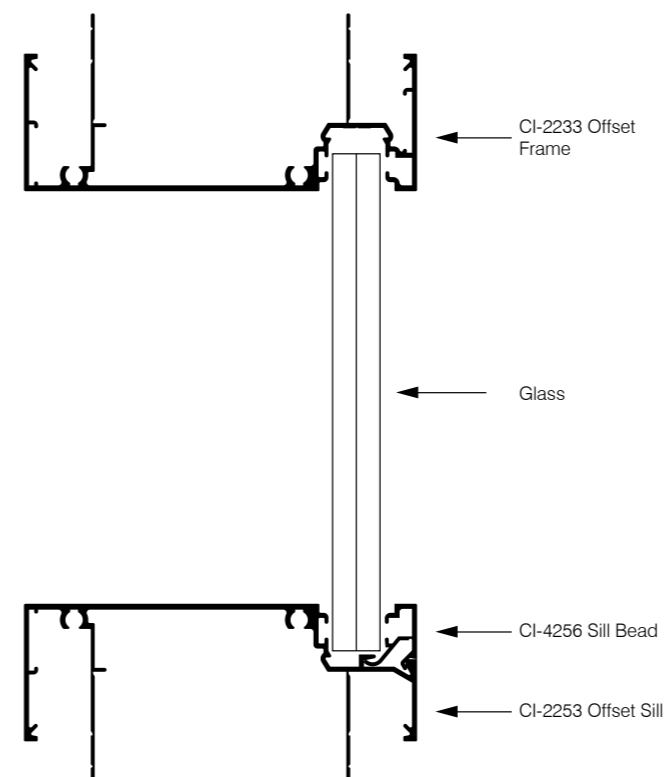

Double Glazing Elevation

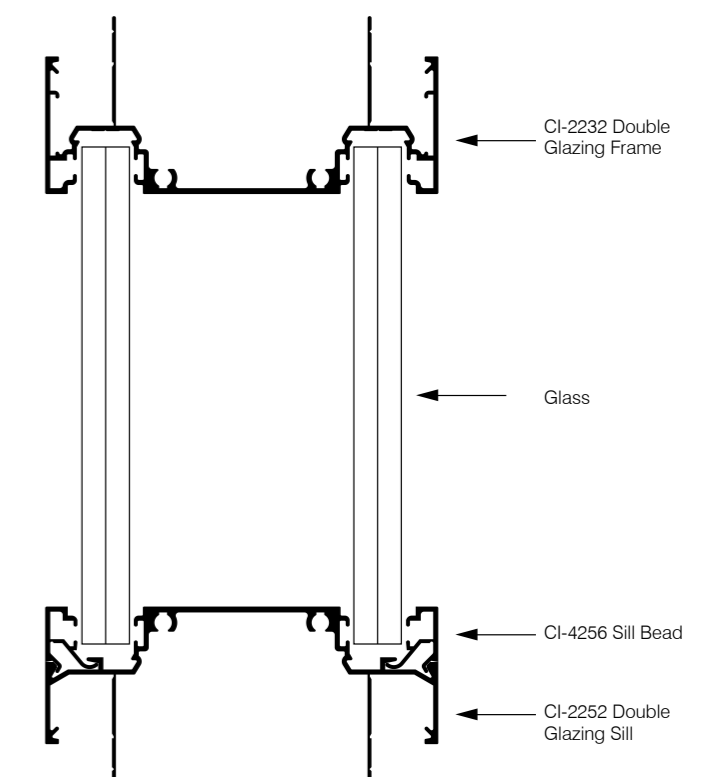

Platinum 90

To suit 64mm Studs

Plan View

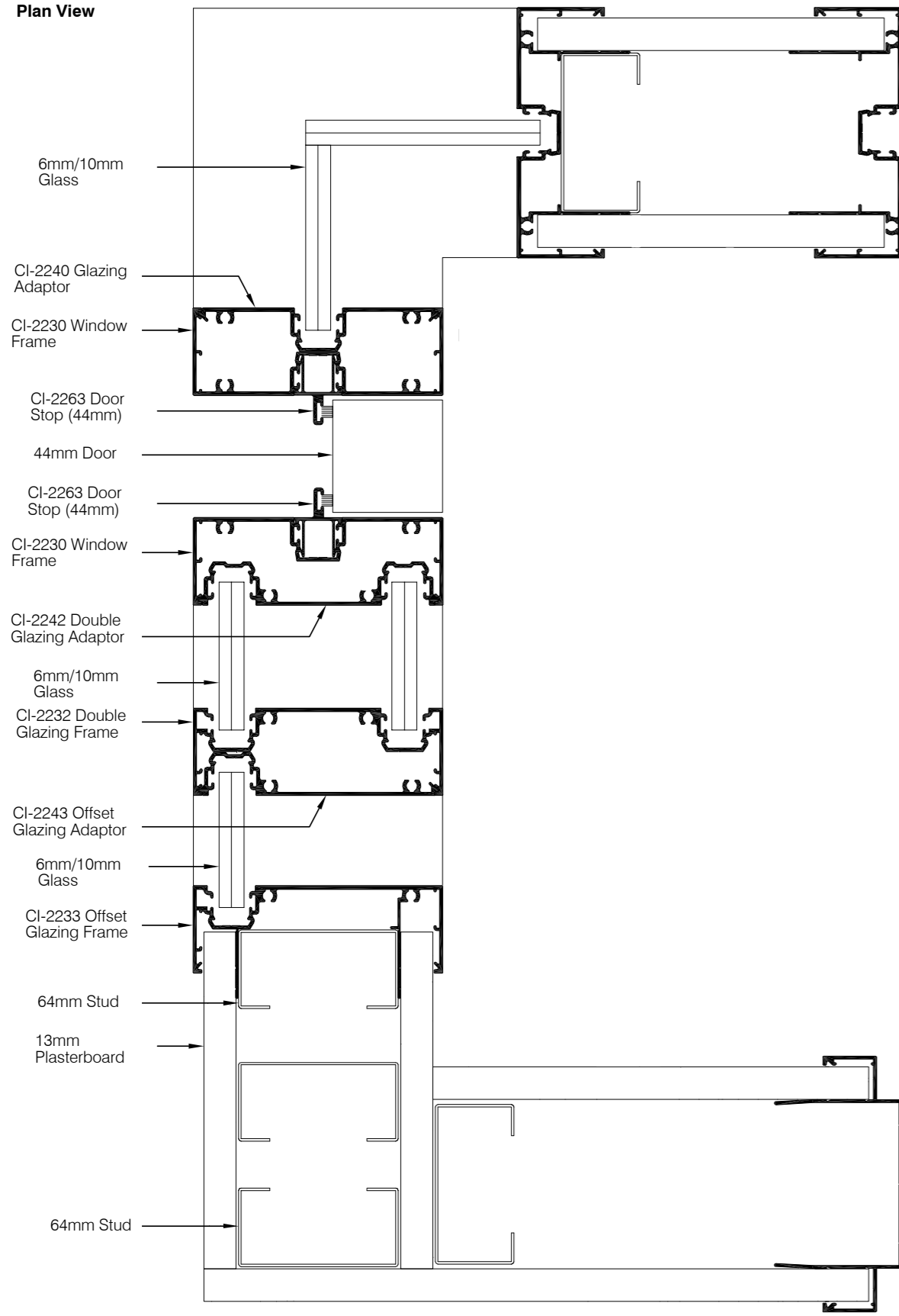

Platinum 90

To suit 64mm Studs

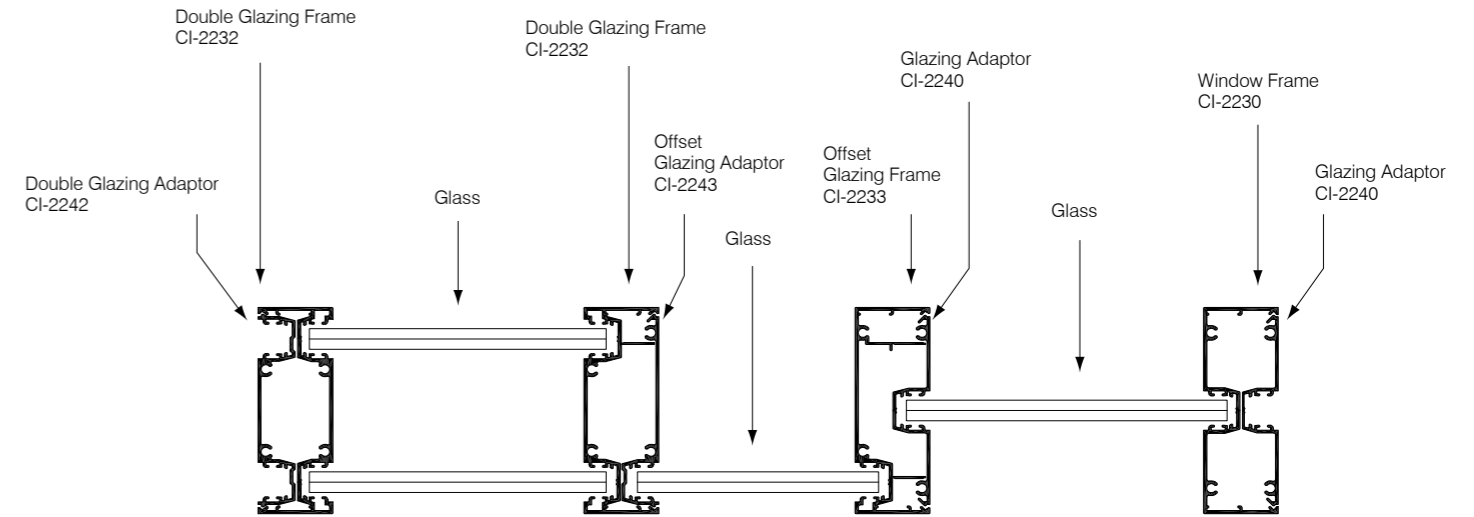

Offset Glazing Elevation

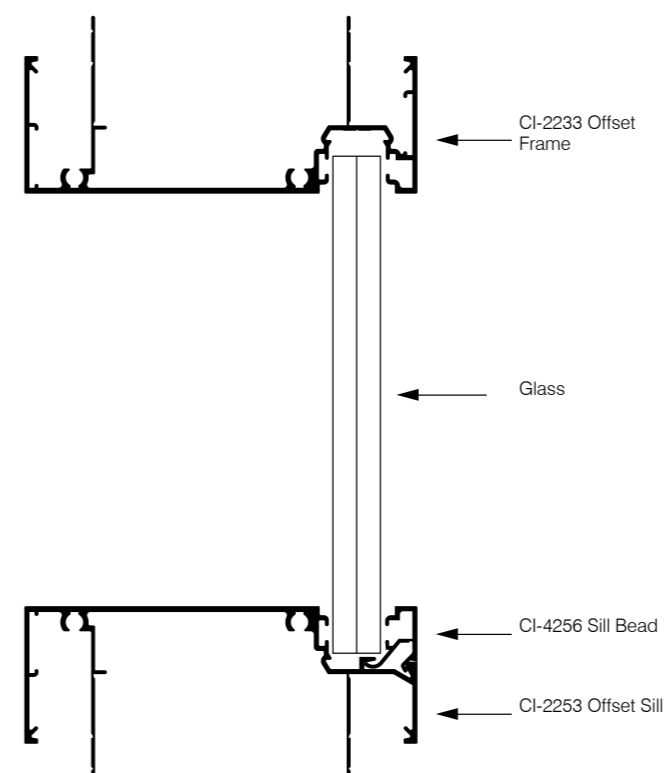

Double Glazing Elevation

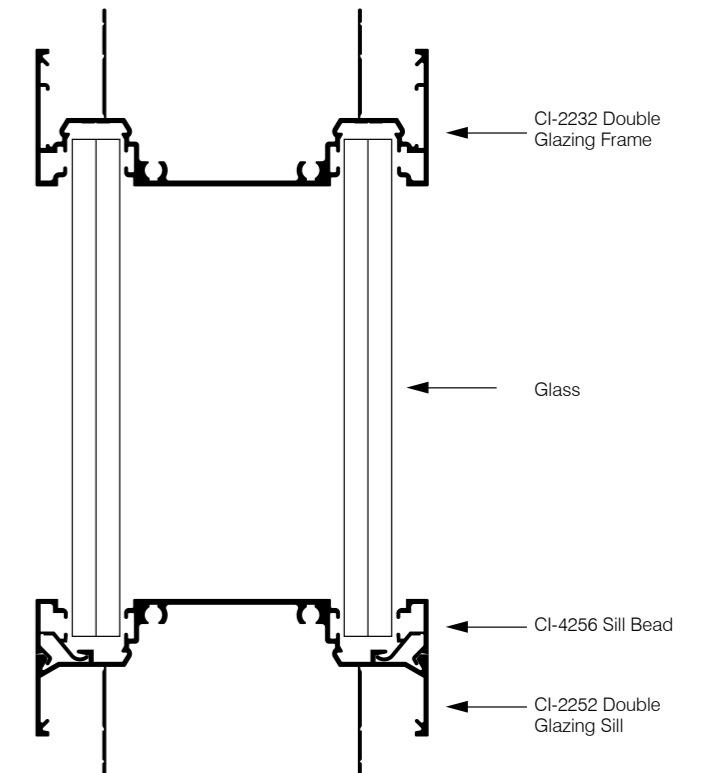

Platinum 105

To suit 76mm Studs

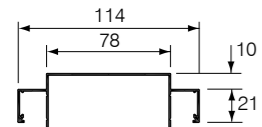

Ceiling Channel
CI-3211
(CI-7601)

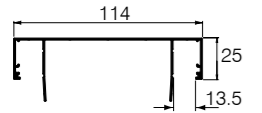

Ceiling Channel
(No Shadowline)
CI-3410

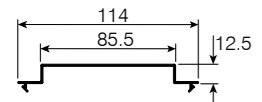

Shadowline Adaptor
CI-3215

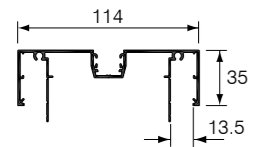

Door Frame
CI-3220
(CI-7602)

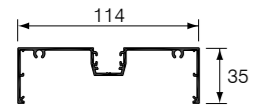

Window Frame
CI-3230
(CI-7603)

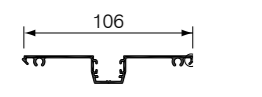

Glazing Adaptor
CI-3240
(CI-7604)

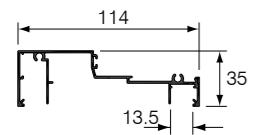

Window Sill
CI-3250
(CI-7605)

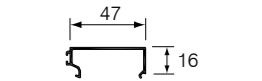

Sill Bead
CI-3251
(CI-7606)

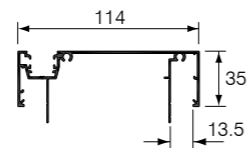

Offset Glazing Frame
CI-3233
(CI-7632)

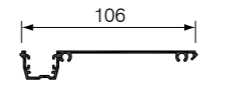

Offset Glazing Adaptor
CI-3243
(CI-7634)

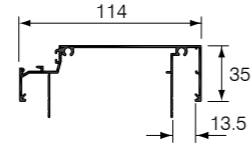

Offset Glazing Sill
CI-3253
(CI-7635)



Offset Glazing Bead
CI-4256
(CI-9236)



Door Stop (38mm)
CI-4963



Door Stop (35mm)
CI-4263



Door Stop (44mm)
CI-2261
(CI-6408)



Pocket Filler
CI-4260
(CI-9209)

Full Height Solid Elevation

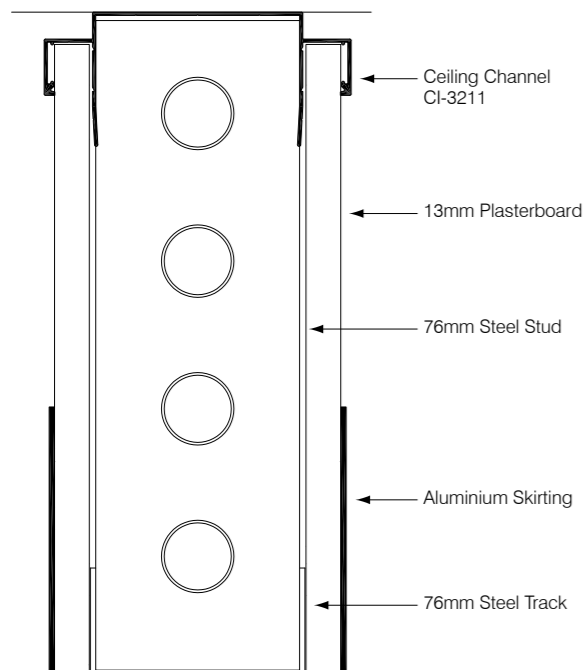

Half Height Glazing Elevation

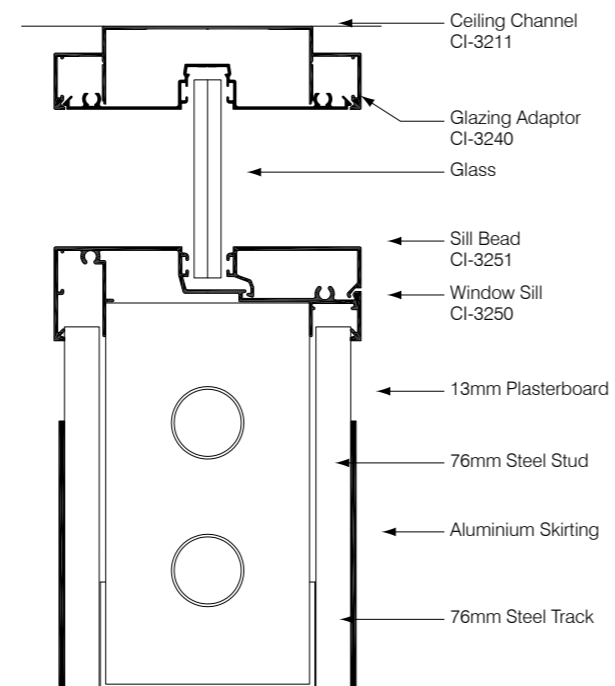

Platinum 105

To suit 76mm Studs

Plan View

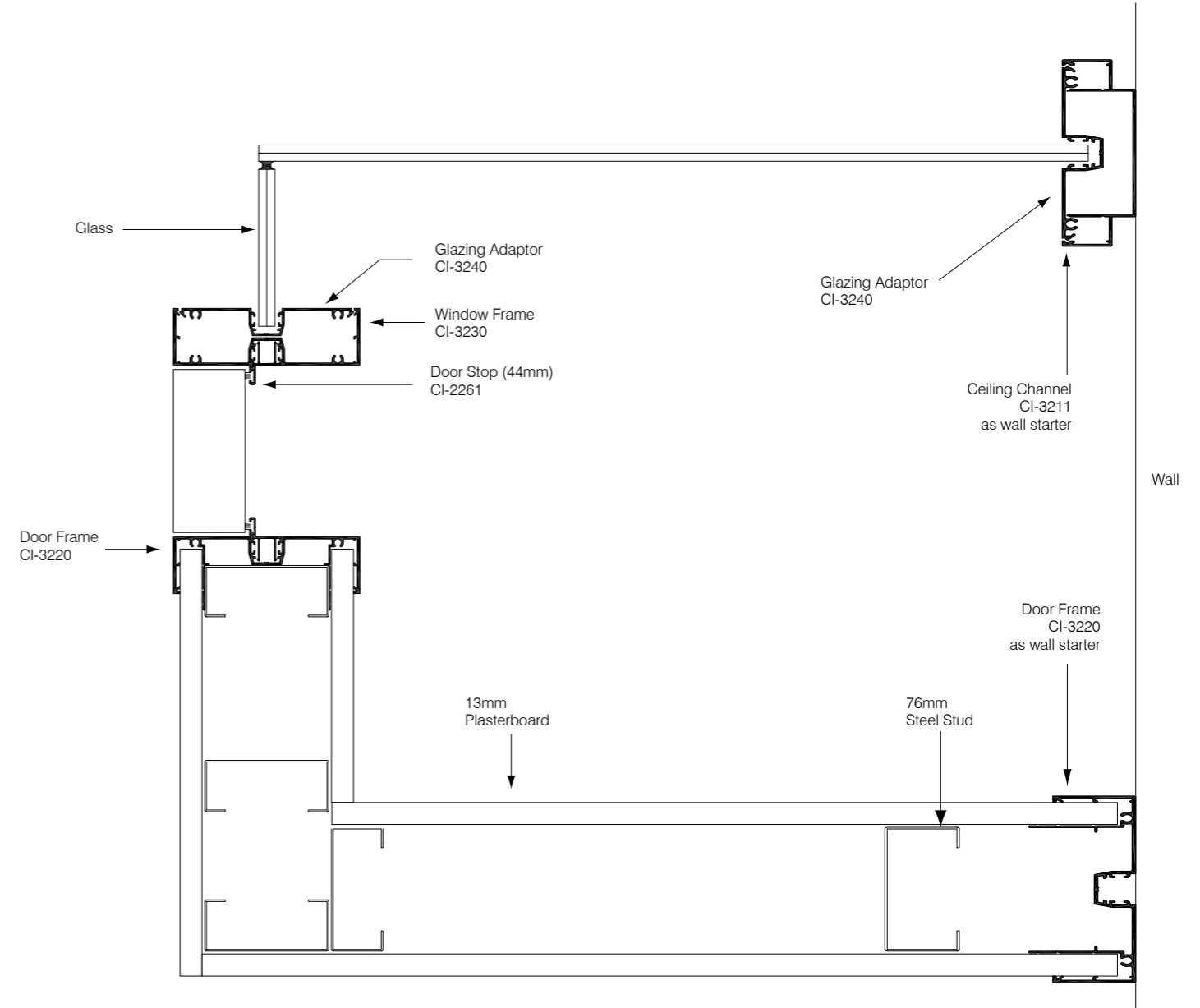

Platinum 110

To suit 92mm Studs / 10mm Plasterboard

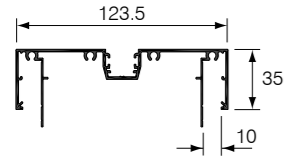

Door Frame
CI-4920
(CI-9102)

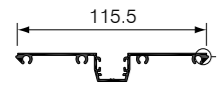

Glazing Adaptor
CI-4940
(CI-9104)

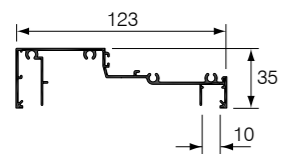

Window Sill
CI-4950
(CI-9105)

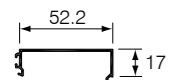

Sill Bead
CI-4951
(CI-9106)

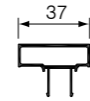

Heavy Duty Stop
(38/44mm)
CI-4964
(CI-9110)

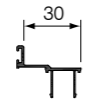

Door Stop (35mm)
CI-4262
(CI-9208)

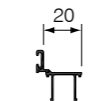

Door Stop (44mm)
CI-4963
(CI-9111)

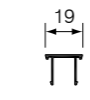

Pocket Filler
CI-4260
(CI-9209)

Low Height Door Elevation

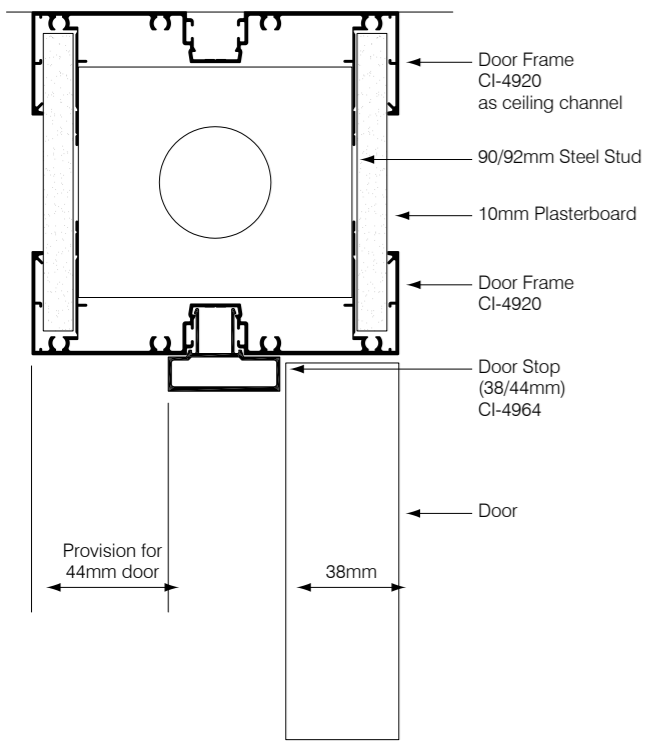

Full Height Glazing Elevation

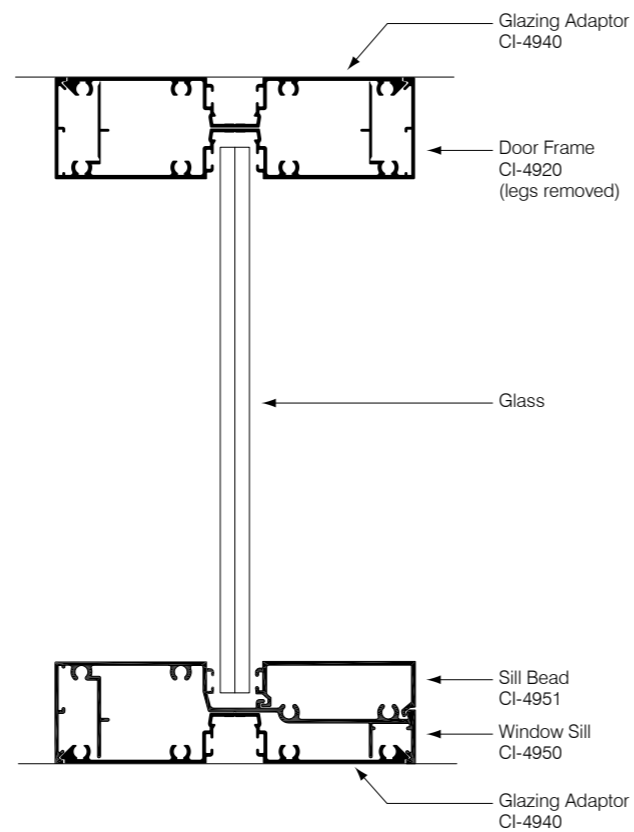

Platinum 110

To suit 92mm Studs / 10mm Plasterboard

Plan View

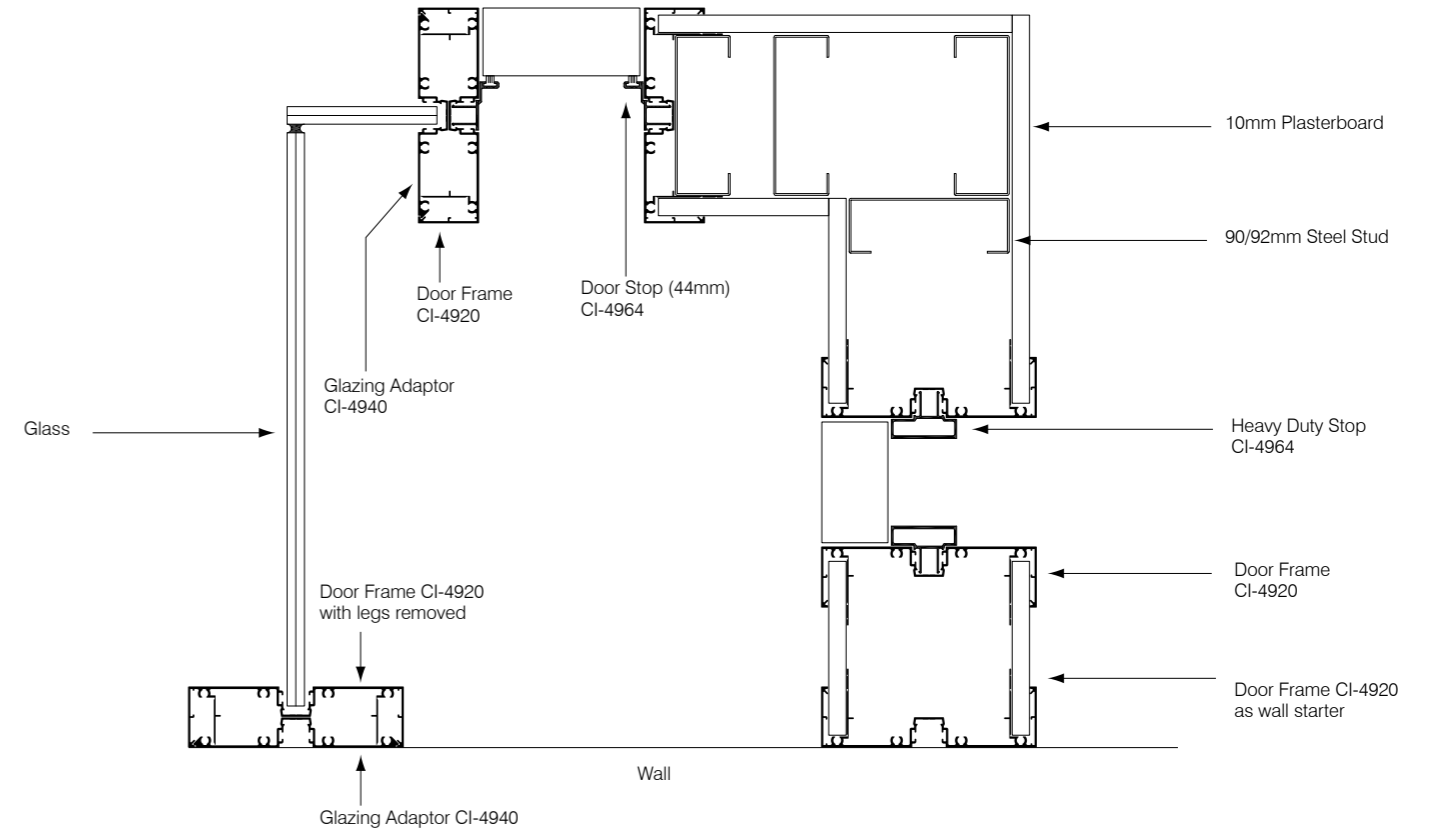

Platinum 120

To suit 92mm Studs

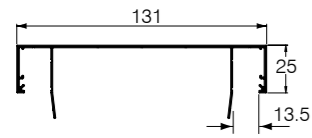

Ceiling Channel
(No shadowline)
CI-4410

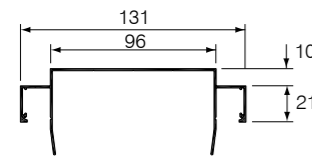

Ceiling Channel
CI-4211
(CI-9201)

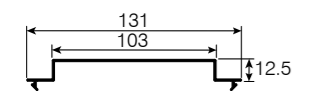

Shadowline Adaptor
CI-4215

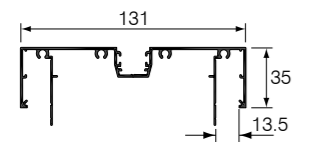

Door Frame
CI-4220
(CI-9202)

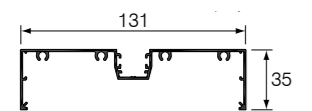

Window Frame
CI-4230
(CI-9203)

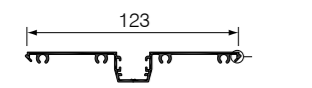

Glazing Adaptor
CI-4240
(CI-9204)

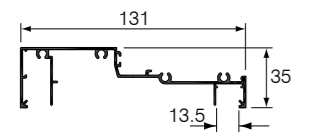

Window Sill
CI-4250
(CI-9205)

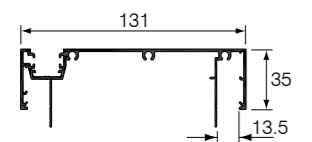

Offset Glazing Frame
CI-4233
(CI-9232)

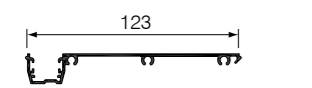

Offset Glazing Adaptor
CI-4243
(CI-9234)

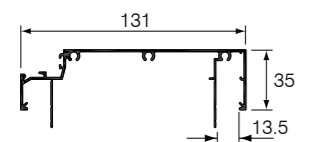

Offset Glazing Sill
CI-4253
(CI-9235)

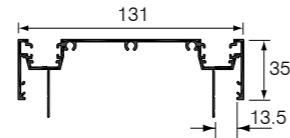

Double Glazing Frame
CI-4232
(CI-9242)

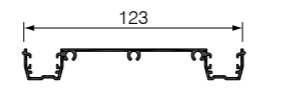

Double Glazing Adaptor
CI-4242
(CI-9244)

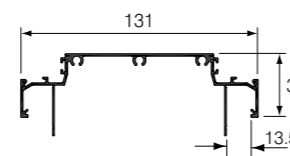

Double Glazing Sill
CI-4252
(CI-9245)

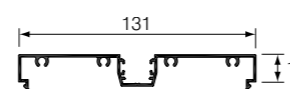

Frame Adaptor
CI-4241
(CI-9220)

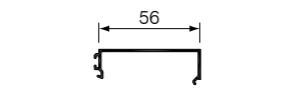

Sill Bead
CI-4251
(CI-9206)

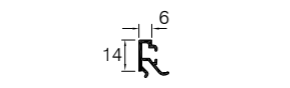

Offset Glazing Bead
CI-4256
(CI-9236)

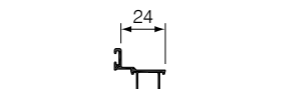

Door Stop (44mm)
CI-4263
(CI-9207)

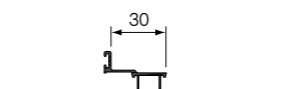

Door Stop (38mm)
CI-4262
(CI-9208)

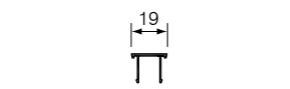

Pocket Filler
CI-4260
(CI-9209)

Platinum 120

To suit 92mm Studs

Plan View

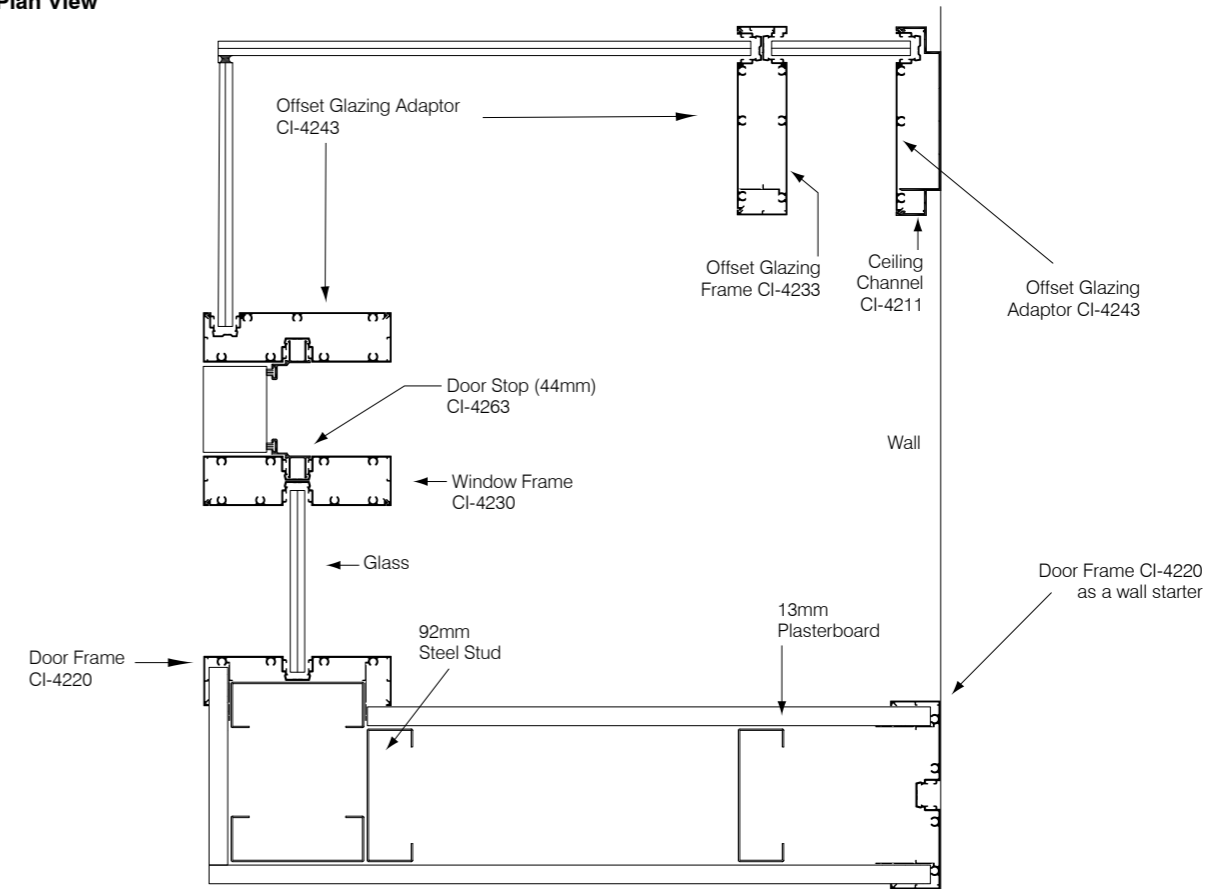

Half Height Double Glazing Elevation

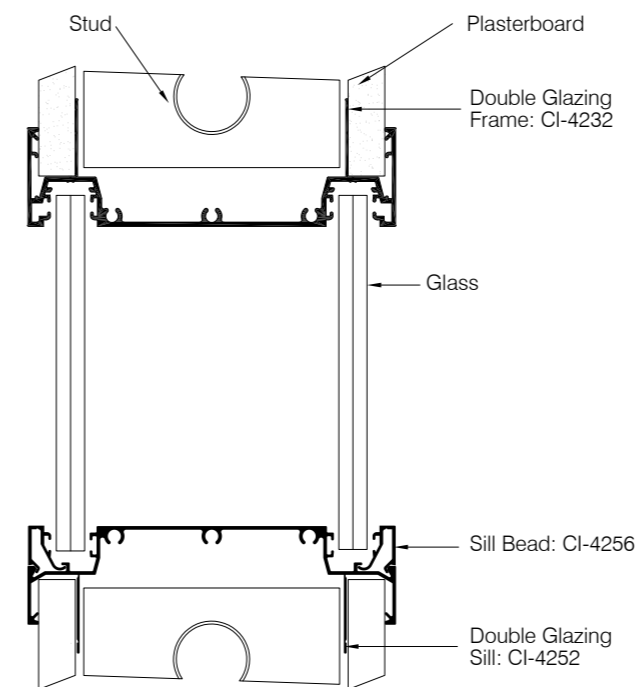

Centre Glazing Elevation

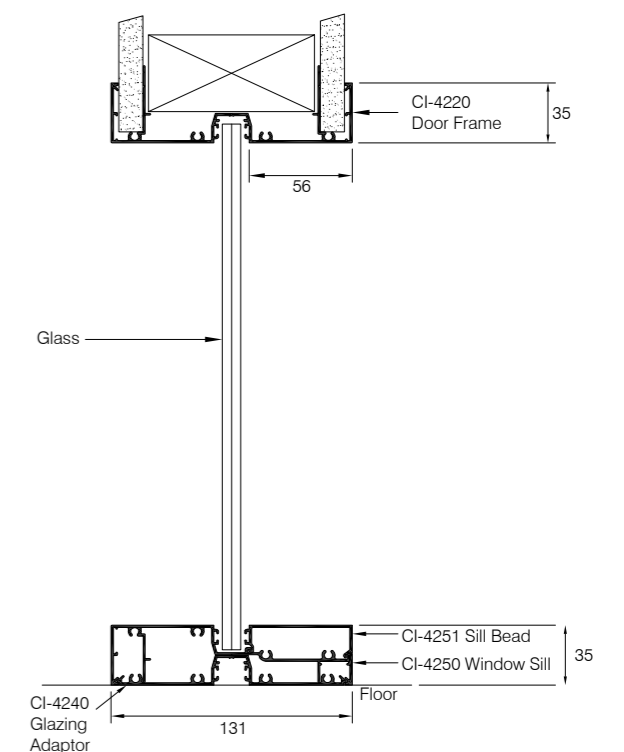

Criterion Industries (VIC)

15 Corporate Place
Broadmeadows VIC 3047

Telephone 03 9355 0700
Facsimile 03 9355 0777

sales@criterionindustries.com.au
www.criterionindustries.com.au

Criterion Industries (NSW)

95 Victoria Street
Smithfield NSW 2164

Telephone 02 9355 0700
Facsimile 02 9355 0777

sales.nsw@criterionindustries.com.au
www.criterionindustries.com.au

Criterion Industries (WA)

58 Tacoma Circuit
Canning Vale WA 6155

Telephone 08 9355 0700
Facsimile 08 9355 0702

sales.wa@criterionindustries.com.au
www.criterionindustries.com.au