



# Axis Zipscreen



Australia's Specialist Manufacturer of Blinds and Curtains  
for Commercial and Multi-Residential Buildings

[www.norfolkblinds.com.au](http://www.norfolkblinds.com.au)

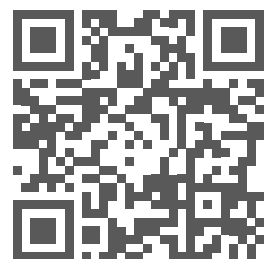

# Axis Zipscreen

Axis Zipscreen gives you privacy and year-round protection as well as keeping you safe from the elements and insects.

Enhance your living space and create an outdoor haven.

Experience true relaxation and comfortable entertainment without the time-consuming stress and cost of traditional renovations.

Axis Zipscreen is Australian designed and manufactured and features the latest in technological innovation – ensuring the finest outdoor shade solution.

- One action Ultra Lock, exclusive to Axis Zipscreen.
- Customised headbox configurations
- Hidden fabric retention, concealed within the channels.
- Up to 5.8mtrs wide with a 4mtr drop.

## AVAILABLE COLOURS

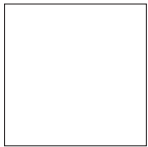

White



Classic Cream



Anodised



Monument



Woodland Grey



Black



# Axis Zipscreen



CUSTOMISED HEADBOX CONFIGURATION

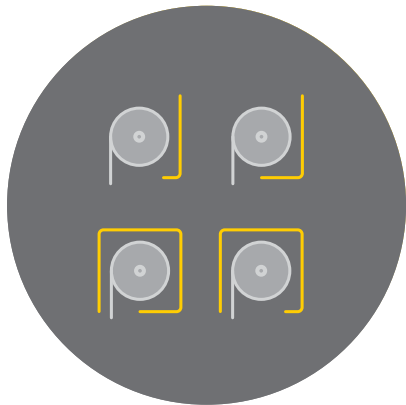

ONE ACTION ULTRA-LOCK

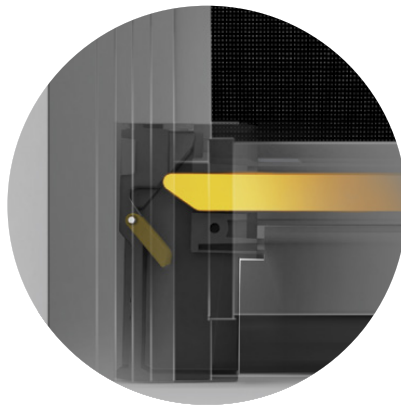

HIDDEN FABRIC RETENTION

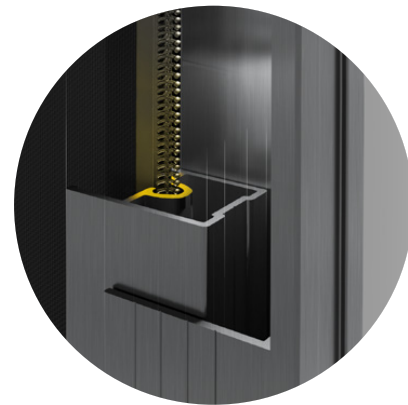

## SYSTEM OPTIONS



Spring  
control



Crank  
control



Remote  
control

# Axis Zipscreen

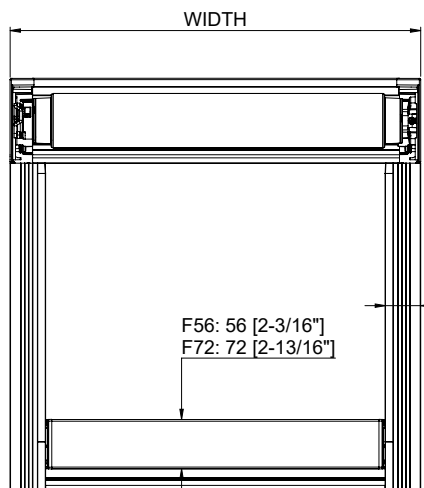
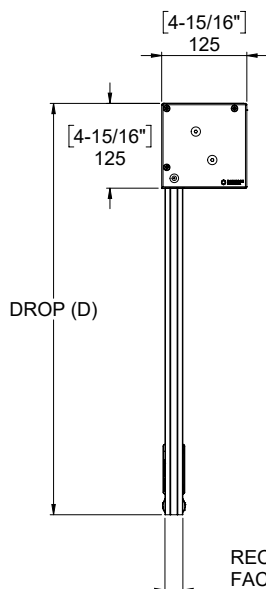
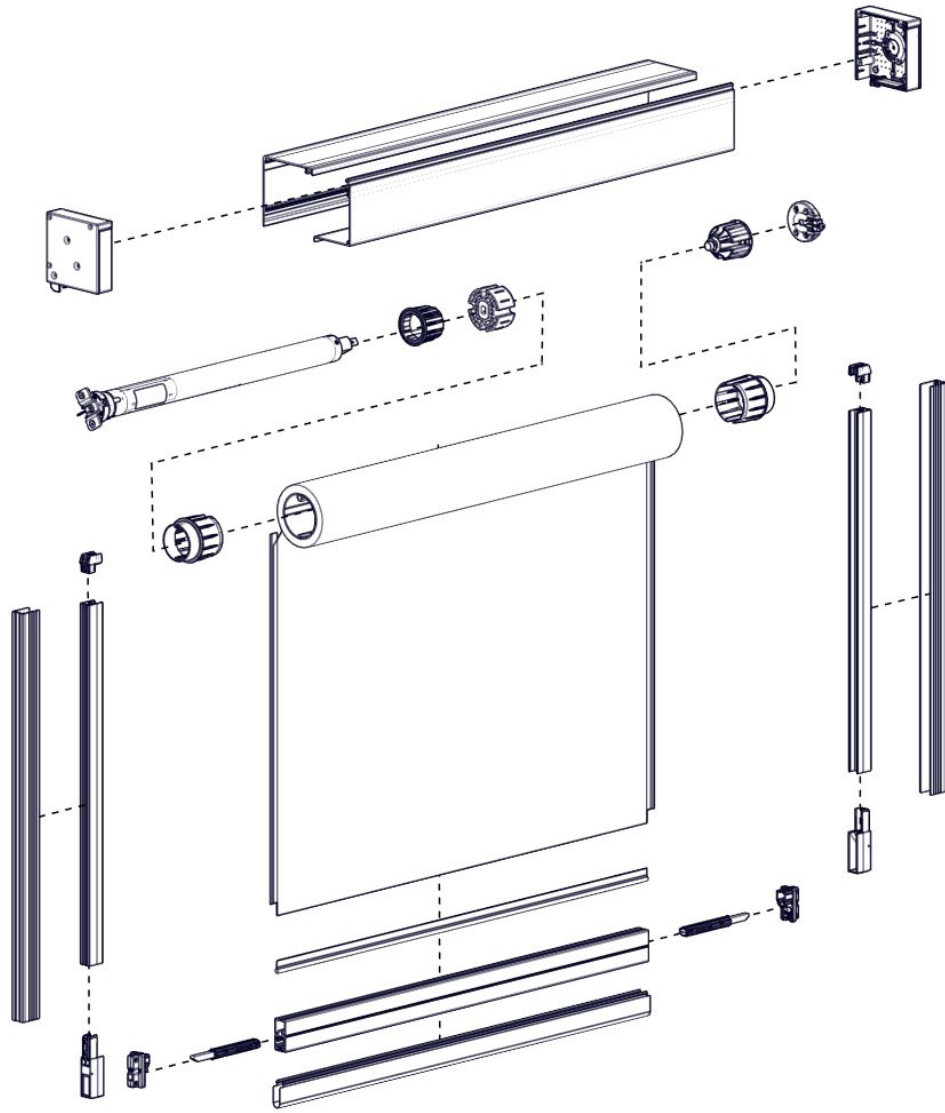

RECESS FIX:  $26$  [ $1\text{-}1/16"$ ]  
 FACE FIX:  $31$  [ $1\text{-}1/4"$ ]