

# Zip HydroTap for the workplace



PURE-TASTING | INSTANT | **BOILING** | CHILLED | **SPARKLING**



POWERED BY  
**G5**  
TECHNOLOGY

Experience water at its best



Introduction	2
Water at its best	3 & 4
Classic Plus	7
Touch-Free Wave	8
Zip Micro	9
UltraCare	10
G5 technology	11 & 12
Filtration technology	13
Healthier workplace	14
Widest range and finishes	15 & 16
Environmental product declaration	17
Safe and accessible	19
Zip service difference	20
Zip innovation history timeline	21 & 22

HydroTap Classic range	
Touch-Free Wave	25
Touch-Free Wave with Mixer	26
Classic Plus	27
Classic Plus with Mixer	28
Classic	29
Classic with Mixer	30
Classic All-In-One	31
Classic Industrial	32
Classic for accessibility	33

HydroTap Design range	
Arc	37
Arc with Mixer	38
Cube	39
Cube with Mixer	40
Elite	41
Elite with Mixer	42

HydroTap Celsius range	
Celsius All-In-One	45
Celsius Arc	47
Celsius Cube	48
Micro	49

Technical data	
Classic Plus	50
Touch-Free-Wave	52
Classic	54
Industrial	56
Arc	57
Cube	58
Elite	59
Celsius All-In-One	61
Celsius Arc	61
Celsius Cube	61
Technical information	62

Consumables and accessories	
Accessories	64
Installation accessories	64
HydroTap filters and CO <sub>2</sub>	65





## 70 years of innovation

With unrivalled expertise in instant filtered boiling, chilled and sparkling water, Zip Water is known globally for being home to the Zip HydroTap, which dispenses pure-tasting water at the touch of a button.

Founded in Australia in 1947, we've always been innovators, advancing and perfecting our drinking water technology for decades. Today, we're proud to provide workplaces, in over 70 countries across the world with the purest tasting water possible from our range of Zip HydroTaps.

Access the latest water filtration technology for pure-tasting water. Convenience at the touch of a button for instant boiled, chilled and sparkling water. Stylish designs and finishes to suit any kitchen and declutter bench space for efficiency. Keep up with the busy demands of a workplace with Zip HydroTap technology.

Welcome to the Zip HydroTap family.

John Doumani, President Zip Industries

**Featured product**  
HydroTap Classic Plus in Chrome finish





# Experience water at its best with Zip HydroTap

## Convenience of instant pure-tasting water at the touch of a button

Enjoy pure-tasting boiling, chilled and sparkling water flowing from the simplest of touches with the Zip HydroTap G5. With sleek design and slick function powered by our most advanced technology, the HydroTap G5 has more personalised settings and features SteriTouch® for enhanced hygiene. It's not just water, it's water at its best.



FILTERED  
BOILING



FILTERED  
CHILLED



FILTERED  
SPARKLING



FILTERED  
AMBIENT



UNFILTERED  
HOT & COLD



POWERED BY  
**G5**  
TECHNOLOGY

# Powered by our latest G5 technology

Zip HydroTap's superior filtration and compact, efficient design makes it the perfect water solution for any workspace.

Remove kettles from your benchtops. Eliminate refrigerated bottles of still and sparkling water. Save space, energy and money. Forget deliveries and storage of water cooler bottles.

The Zip HydroTap is a convenient and practical way to offer your staff, customers and visitors fresh, pure-tasting water – instantly and safely.



# Experience water at its best with HydroTap in the workplace

Pure-tasting boiling, chilled and sparkling water in an instant, delivered seamlessly with a Zip HydroTap. There is a HydroTap to suit any workplace.

## For the office workplace

Workplace productivity and wellbeing is vital to your team environment. Zip HydroTap meets all your workplace water needs, in one elegant, easy-to-use system, using the latest technology so that it can keep up with a busy workplace. Introducing our latest addition to our flagship HydroTap range - Classic Plus.



## For touch-free workplaces

With an increased consideration around hygiene in the workplace, Zip HydroTap Touch-Free Wave provides a 100% touch-free solution to instantly dispense pure-tasting drinking water with a simple wave of a hand.



## For the small workplace

Award winning Zip Micro is our smallest ever drinking water system, designed to fit under almost any bench and keeps up to 10 people hydrated – the perfect solution for smaller offices.



## For health and aged care facilities

For health and aged care facilities, HydroTap UltraCare is proven to deliver a 99.9% reduction in Legionella\*.



\*ALS Pty Ltd Testing of the Zip HydroTap UltraCare system efficacy tests



Featured product HydroTap Classic All-In-One installed over sink in Matte Black finish

# Say hello to the new Classic Plus

## Sleek design meets slick function

With simple, intuitive controls including continuous flow to fill bottles and coming in seven ultra-modern finishes, HydroTap Classic Plus will offer instant hydration and convenience to any workplace.

## Smarter and sustainable

Customise your HydroTap G5 system by selecting energy modes and usage settings with the optimised new menu. With easy to change high quality filters, a Zip HydroTap will support your sustainability ambitions and remove the need for bottled water in the workplace.

## Protection where it counts

Zip HydroTap G5 has SteriTouch® antimicrobial protection impregnated within key water surfaces as well as on the new Classic Plus touch-pad for enhanced hygiene.



# Create a safer workplace with HydroTap Touch-Free Wave



Introducing Zip HydroTap Touch-Free Wave, with smart infrared sensors that activate boiling, chilled and sparkling water.

With an increased consideration around hygiene in the workplace, new Zip HydroTap Touch-Free Wave provides a 100% touch-free solution to instantly dispense pure-tasting drinking water with a simple wave of a hand.

## How it works

- Infrared smart sensors detect hand movements within 1.5 - 5cm in range of the tap
- Once the hand moves away, the water flow will stop
- All drinking water types will have a maximum run time of 15 seconds which is adjustable from the command centre

## Safety features

- Twin sensor activation for safe delivery of boiling water



- Dispensing will deactivate when the tap is touched or grabbed, allowing for safe cleaning



Wave right for chilled



Wave above for sparkling



Twin sensor activation for boiling



Infrared sensor



Touch-free activation



1.5-5cm sensor range



Deactivates when touched



# Zip Micro, our smallest ever drinking water system



**37%\***  
narrower  
to fit under almost  
any bench

Zip Micro is 37% narrower, perfect for small kitchens for up to 10 people, delivering perfectly **boiling** and **chilled** water at your fingertips.



- Designed with space in mind**  
Our smallest under-bench system footprint is 37%\* narrower.
- Optimised for up to 10 people**  
Keep up to 10 people hydrated with boiling only or boiling + chilled filtered water options.
- Easy to use**  
The Zip Micro tap design comes with an integrated safety lock and uses an intuitive twist activation with auto and manual fill options. The underbench system comes with pre-configured settings and modes.
- Micro-filtration for pure tasting water**  
Zip Micro uses the latest filtration technology for pure-tasting water. Zip filters are certified to reduce bacteria, sediment, odours to NSF 42 (aesthetic effects) and NSF 53 (health effects).



## 2020 Gold Accolade Winner

in the Product Design Domestic Appliances category in recognition for outstanding design and innovation.

Zip Micro is displayed with an optional font kit sold separately (includes 100mm extension and matching stand alone font).  
\*37% narrower than HydroTap BC 100/75 underbench command centre

# The Zip HydroTap UltraCare system is proven to deliver 99.9% reduction in Legionella\*

Zip HydroTap UltraCare uses a combination of localised treatments and barriers that are proven as the most effective method of reducing waterborne organisms and pathogens including Legionella. Zip HydroTap UltraCare system is proven to deliver a 99.9% reduction in Legionella\*. These barriers have been outlined in the enHealth (2015) guidelines for Legionella control in operation and maintenance of water distribution systems in health and aged care facilities.

The barriers provided in the UltraCare system are:

- MicroPurity™ 0.2-micron carbon-free filtration
- SteriTouch® antimicrobial enhanced surfaces
- MicroPurity™ UV-C LED disinfection
- Lifecycle maintenance plan
- Zip HydroCare Gold+

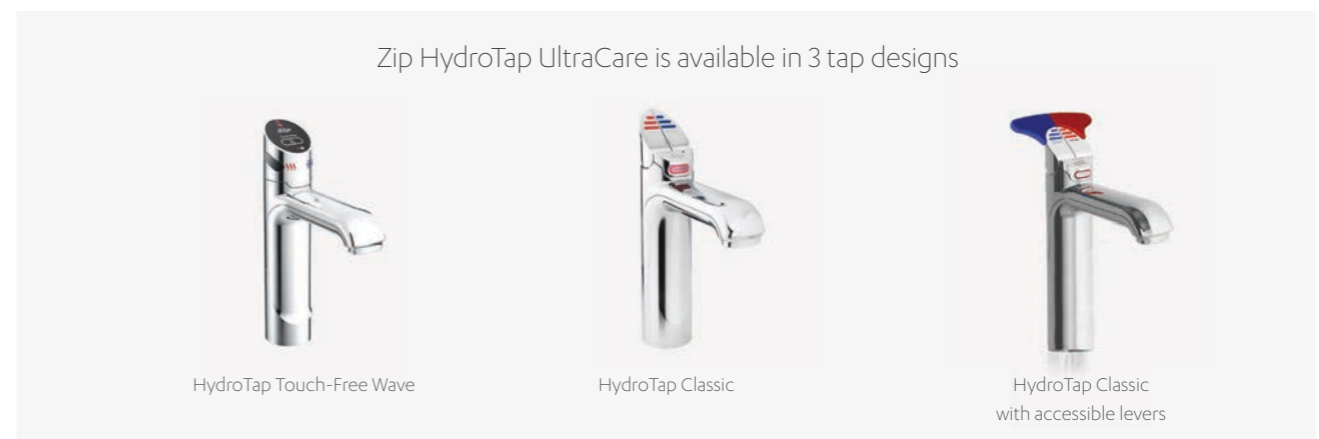
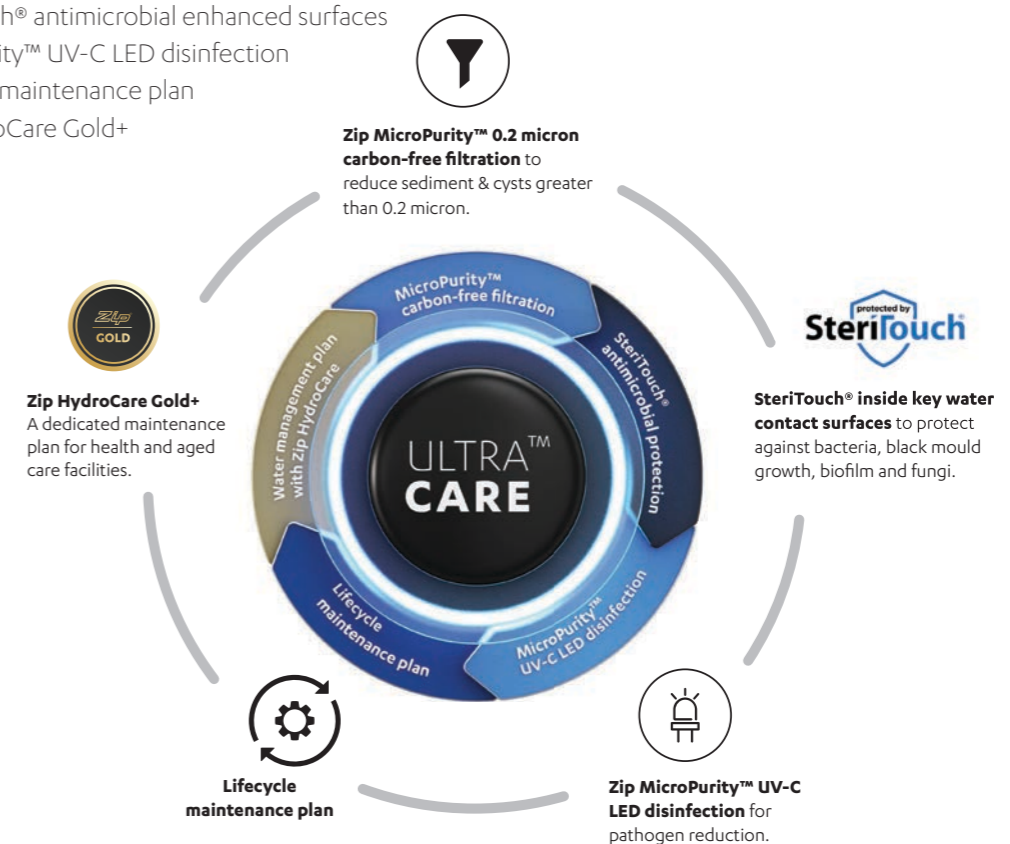

\*ALS Pty Ltd Testing of the Zip HydroTap UltraCare system efficacy tests

# HydroTap, powered by new G5 technology

Leading the way in performance and functionality, Zip's fifth generation G5 technology continues to deliver the convenience you would expect from a HydroTap.

Perfected over 70 years of development and innovation, HydroTap G5 transforms tap water into a form you will love, in an instant.

The G5 command centre is WaterMark approved, which means it is fit for purpose and appropriately authorised for use in plumbing and drainage installations.



## HydroTap product warranty

Zip HydroTap G5 is backed by a 36 month comprehensive parts and labour warranty, plus a further 24 months on internal tanks.

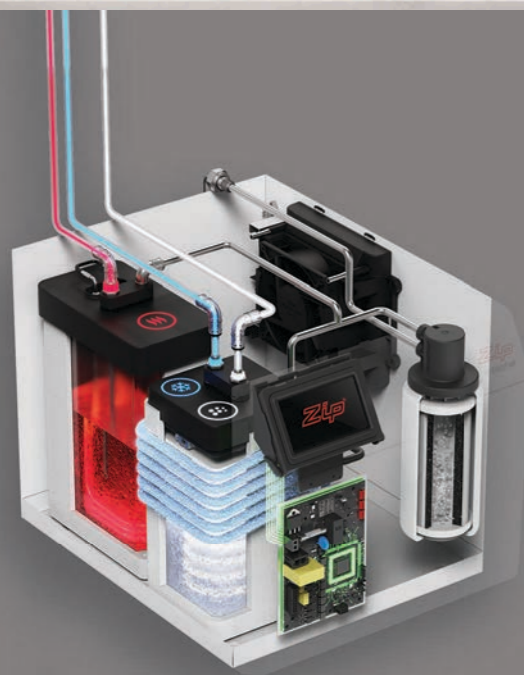
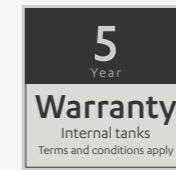

### PowerPulse technology



Our innovative Zip PowerPulse technology maintains stored boiling water to within 0.2°C of your set temperature, meaning no energy or time is wasted waiting for water to boil.

### Unique safety features



Zip boiling water is delivered smoothly and the tap has a safety lock to facilitate safe boiling water delivery.

### Air-cooled system



Our unique air-cooled refrigeration system is 100% water efficient.

### Auto-diagnostics



An advanced auto-diagnostics system continuously monitors your HydroTap's performance.

### MicroPurity™ filtration



Inbuilt 0.2 micron NSF-certified filter incorporating innovative silver ion antimicrobial technology means healthier, pure-tasting water for your workplace.

### Smart Customisation



New optimised menu in the G5 HydroTap command centre allows you to select energy modes and usage settings for easier customisation.

### SteriTouch® antimicrobial protection



SteriTouch® is impregnated inside materials in contact with key water paths in HydroTap for added protection against surface bacteria.

### Touch-Free Technology



Zip HydroTap Touch-Free Wave uses smart infrared sensors to activate the tap to dispense boiling, chilled and sparkling water, all without touching the tap.

### CO<sub>2</sub> level indicator



New feature in the command centre shows when CO<sub>2</sub> gas is running low.





# Pure-tasting filtered water with Zip MicroPurity filtration

At Zip Water, we put water quality at the heart of our offering, with perfectly filtered boiling, chilled and sparkling water instantly.

Our mission is to help our customers to enjoy pure-tasting water, on tap, all the time. We have the same passion for water as you do- water is our drink of choice, it's one of life's natural luxuries and that's why only the best tasting water will do.

Crystal clear pure-tasting water

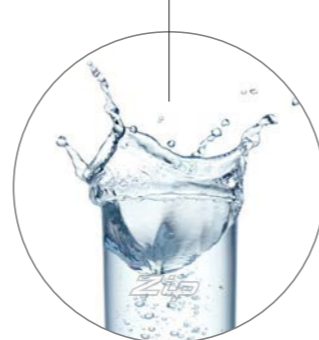

**MICROPURITY™  
FILTRATION**

SAFELY FILTERS DOWN TO 0.2 MICRON

## Advanced filtration in every HydroTap system

Zip MicroPurity uses the latest filtration technology to filter and reduce impurities and potentially harmful contaminants larger than 0.2 microns in size – an impurity that will fit 250 times into a strand of hair.

## Easy to maintain

We recommend regular filter changes to ensure you continue to enjoy pure-tasting water. Our MicroPurity filters are easy to change with a hygienic cartridge and our qualified service technicians can also perform filter changes for your convenience.

## Trust Zip genuine filters

Every Zip HydroTap system comes fitted with a genuine MicroPurity filter, which are certified to reduce contaminants.

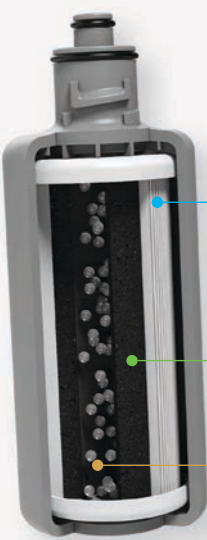



### Triple Action Technology

- 1. Removes particulates greater than 5 micron**  
Pleated membrane pre-filtration
- 2. Filter reduces lead, chlorine, taste, odour and cycts to 0.2 micron**  
0.2 micron Fibredyne carbon element including bacteriostatis effect
- 3. Reduces limescale build up**  
Limescale inhibitor

Zip MicroPurity filters are certified to reduce chlorine, taste, odour, bacteria, sediment and limescale in line with NSF 42 (aesthetic effects) and WaterMark requirements.

Zip MicroPurity filtration is also certified to deliver a reduction of 99.9% of cysts including cryptosporidium and giardia, and lead reduction of 98.9% to NSF 53 (health effects).



# Water for a healthier workplace

Workplace wellness and wellbeing is vital to your team remaining engaged and productive. Water plays a significant role in the function of the brain, so ensuring your staff have access to fresh, healthy water is essential.

Zip Water research shows that 80% of Zip HydroTap owners drink more water than before\*. Drinking more water offers a range of benefits, such as better concentration and less fatigue. Plus, the increased activity from getting up and moving around increases circulation, encourages the elimination of waste and toxins, and reduces the damaging effects of long periods of inactivity.

Zip HydroTap meets all your workplace water solution needs, in one elegant, easy to use system.

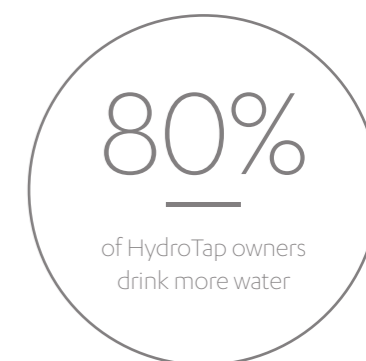

\*Research carried out to 340 existing Zip HydroTap customers

**Featured product**  
HydroTap All-in-One Classic  
in Chrome finish

# The widest range of designs and finishes



**NEW** Touch-Free Wave\*\*    **NEW** Classic Plus    Classic\*    Classic All-In-One\*    Elite    Micro\*\*\*



Arc    Cube    Celsius All-In-One    Celsius Arc    Celsius Cube

## Popular finish options

Whether you opt for a classic bright chrome or stylish matte black, our range of timeless popular finishes has been designed to sit seamlessly in a wide range of kitchen designs, from contemporary to traditional.

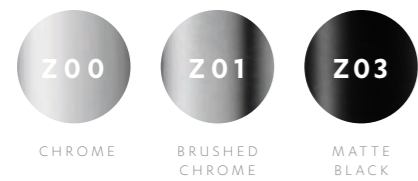

## Platinum finish options

Taking the HydroTap from a kitchen appliance you can't live without to a striking design accessory, our platinum finish options include stylish metallic finishes, each stunning in its own right.



\*Available only in popular finish options  
 \*\*Available now in Chrome. Contact Zip Water on availability on Touch-Free Wave in a Matte Black finish  
 \*\*\*Available only in Chrome and Matte Black finish options



# Environmentally responsible

## Independently verified Environmental Product Declaration

In another first for the world leaders in instant drinking water systems, Zip has released an internationally recognised and independently verified EPD for its HydroTap products. Developed with leading sustainability consulting company, **thinkstep\***, it is the first EPD for an electrical product in Australasia, clearly demonstrating Zip's innovative and forward-thinking approach.

The HydroTap EPD details the environmental impact of the product throughout its lifecycle, from the production and processing of raw materials, to manufacturing, distribution, installation, ongoing usage, maintenance and filter changing, right down to the end of the product's life.

Australians buy **over 580 MILLION** litres of bottled water a year.

Much of which ends up in **LANDFILL** and on our **BEACHES#**

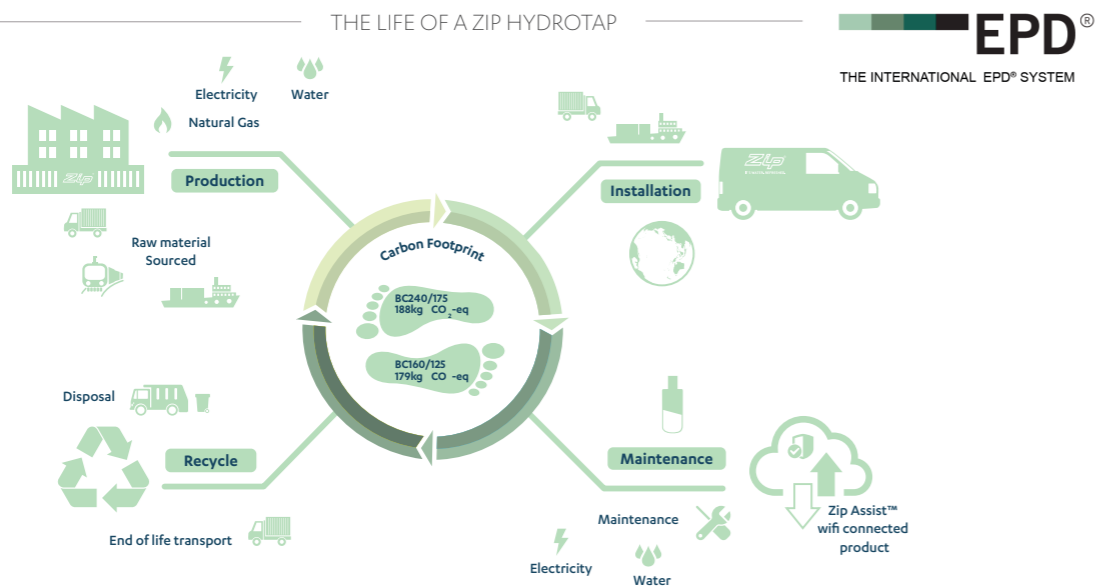

### Responsible manufacturing

Organisational dedication to sustainability



### Innovative air-cooled technology

Making HydroTap 100% water efficient



### Low impact design

Complies with RoHS EU Directive 2002/95/EC



### Smart energy saving modes

Time switch adheres to the Building Code of Australia



### World class environmental credentials

Providing transparent product life cycle impact



### Eliminates the need for bottled water

Reducing your environmental impact



## Sustainable manufacturing

Zip Water products are Australian-made in Condell Park, New South Wales and exported to the rest of the world. Our manufacturing adheres to the highest standards of environmental responsibility and ensures the Zip HydroTap G4 is manufactured sustainably.

**ISO14001** is about much more than just designing an energy efficient product. It is complete organisational dedication to sustainable environmental management and ensures genuine commitment to a sound environment management system.

Zip Water is the only Australian manufacturer in our category to be accredited with all of the following internationally recognised standards:

### ISO14001 –

Environmental Systems compliance and independently audited standards



Environment  
ISO 14001

### ISO9001 –

Quality Management System.



Quality  
ISO 9001

### AS/NZS 4801 –

Workplace Health and Safety System.



Health & Safety  
AS/NZS 4801



#oceanrulers.org/plastic-crusades/plastic-statistics/

\*Thinkstep certified life cycle assessment and EPD verifiers - www.thinkstep-anz.com



## Safe and accessible

All Zip products are designed to be completely safe and easy to use, with unique boiling water safety locks and cool touch technology. You can be confident that the end user can operate our systems safely, without needing to worry about spluttering steam.

For users with limited mobility or impaired vision, Zip HydroTap Classic is also available with accessible levers to cater to their needs. The oversized levers incorporates braille into the colour coded red and blue options to indicate boiling or chilled drinking water.

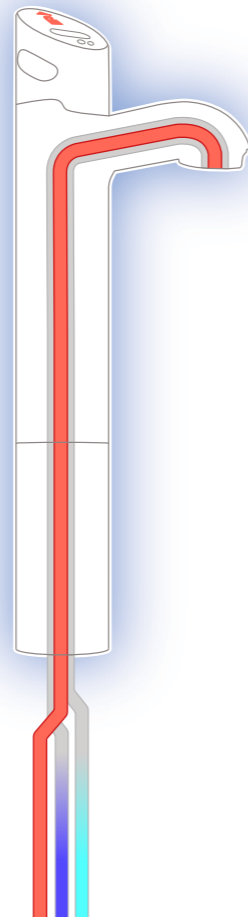

**Featured product**  
HydroTap Classic with oversized levers and braille covers.



## The Zip service difference



Our highly skilled network of mobile technicians and friendly customer service team are here to help keep your Zip products in top working order. Our expert technicians install HydroTaps across residential and commercial kitchens, and we maintain all drinking water systems.

### Full national coverage

With more than 100 Zip specialised technicians and 350 authorised service providers across the country, fully trained and qualified support is never far away.

### Fast and efficient

Every Zip service technician has a full stock of spare parts, genuine filters and CO2 cannisters to repair above 90% on first time attendance, to get you back to enjoying your fresh, filtered water in no time.

### Professional repairs and maintenance

Zip technicians are highly skilled, specialised and factory trained with years of experience to ensure you receive efficient, reliable and prompt service and repairs.

### Be informed with updates

Get up-to-date SMS notifications when your Zip service technician is on their way to your service call to save you time in your day.

### Customer satisfaction

We aim to provide our customers with professional care at a high standard and take pride on our level of service. Over 9000 customers rated the Zip service experience a 9 or 10 out of 10 in 2020.

### HydroTap Product Warranty

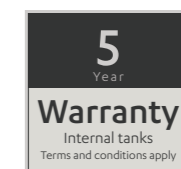
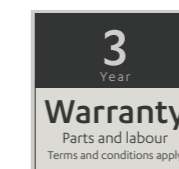

### Let Zip take care of the installation

Zip Water offers an installation service, with a national fleet of skilled service technicians who can install your HydroTap in any kitchen.

Our service technicians will make sure your HydroTap is up and running in no time and includes stone cutting for tap and font installation.

Our service technicians can also help maintain your HydroTap, with a simple online booking form on [zipwater.com](http://zipwater.com)

### Preventative maintenance plans

For ultimate peace of mind, Zip Water's offers professional care of your system with a comprehensive range of HydroCare packages covering every maintenance requirement.

With everything you need to enjoy pure-tasting water, HydroCare ensures your HydroTap not only remains in perfect condition but operates at peak performance.



# A history of drinking water innovation for over 70 years

Zip Water is a world-leading designer and manufacturer of instant boiling, chilled and sparkling filtered water solutions. Zip Water invests in Australian-based innovation design and world-class manufacturing to continually enhance water quality, functionality, energy efficiency and aesthetic appeal. Recognised as a global innovator, Zip Water's products are sought after and installed in over 75 countries worldwide, providing homes and workplaces with the purest-tasting, safest and cleanest water possible.



<p><b>1947</b> Zip founded in Australia as manufacturer of sink and bath heaters</p>	<p><b>1975</b> Zip invents the world's first small On-Wall instant boiling water system</p>	<p><b>1980</b> World's first small on-wall instant boiling water system installed</p>	<p><b>1984</b> Zip Miniboil wins Australian design award</p>	<p><b>1988</b> Zip TeaTap specified into Parliament House Canberra</p>	<p><b>1991</b> Zip opens in the United Kingdom and soon wins a place in 10 Downing Street</p>	<p><b>1993</b> Zip upgrades technology for Hydroboil On-Wall instant boiling water</p>	<p><b>1996</b> Zip launches HydroTap underbench instant boiling water</p>	<p><b>2004</b> Zip HydroTap redesigned wins Australian Design Mark</p>	<p><b>2007</b> Zip introduces advanced electronically controlled Hydroboil</p>	<p><b>2012</b> Zip introduces world's first boiling, chilled and sparkling water on tap</p>
<p><b>1947</b> ————— <b>2021</b></p>										
<p><b>2014</b> Zip introduces G4, the fourth generation of HydroTap</p>	<p><b>2015</b> Zip introduces three new styles with Design Range launch and wins Good Design Award</p>	<p><b>2016</b> Zip introduces eight new Platinum finishes Zip launches Zip Assist wifi connected HydroTap</p>	<p><b>2017</b> Zip introduces Celsius All-in-One Arc and wins Good Design Award</p>	<p><b>2018</b> Zip introduces HydroChill high capacity sparkling water systems</p>	<p><b>2019</b> Zip launches Micro, our smallest drinking water system and wins Good Design Award in 2020</p>	<p><b>2020</b> Zip launches HydroTap Touch-Free Wave, contactless &amp; instant delivery of pure-tasting water</p>	<p><b>2021</b> Zip launches HydroTap G5, the fifth generation of HydroTap and HydroTap UltraCare for health and aged care facilities</p>			



ZIP HYDROTAP COMMERCIAL

# Classic range



## Touch-Free Wave

For workplaces looking to reduce shared touch-points. Zip HydroTap Touch-Free Wave provides a 100% touch-free solution to instantly dispense pure-tasting drinking water with a simple wave of a hand.



## Touch-Free Wave with Mixer

Designed for situations with only a cold water supply. Perfect for workplace kitchens that require a mixer tap and a Zip HydroTap in the same area as well as hot water to the sink.

## Classic Plus

Offering boiling, chilled and sparkling water in a modern design with intuitive controls.



## Classic Plus with Mixer

Designed for situations with only a cold water supply. Perfect for workplace kitchens that require a mixer tap and a Zip HydroTap in the same area as well as hot water to the sink.

## Classic

Offering the choice of instant filtered boiling, chilled or sparkling water, or all three in any combination, the iconic design of the Classic HydroTap remains a much-loved and popular choice suited to any workplace.



## Classic with Mixer

Designed for situations with only a cold water supply. Perfect for workplace kitchens that require a mixer tap and a Zip HydroTap in the same area as well as hot water to the sink.

## Classic All-In-One

The Classic HydroTap All-In-One offers filtered boiling, chilled and sparkling water, plus unfiltered hot and cold water from a single tap.



## Classic for accessibility

For users with limited mobility or impaired vision.

## Classic Industrial

For Industrial and Correctional Facilities. Designed with strength and security, this Zip HydroTap is proven under the toughest industrial and institutional conditions.





# Touch-Free Wave

Featured product  
HydroTap Touch-Free Wave  
in Chrome finish



# Touch-Free Wave with Mixer

Featured product  
HydroTap Touch-Free Wave with Arc Mixer  
installed over sink in Chrome finish



Available water options & finishes:

FILTERED: <b>BOILING</b> CHILLED SPARKLING	FILTERED: <b>BOILING</b> CHILLED	FILTERED: <b>CHILLED</b> SPARKLING	FILTERED: <b>CHILLED</b>	FILTERED: <b>BOILING</b> AMBIENT	FILTERED: <b>BOILING</b>

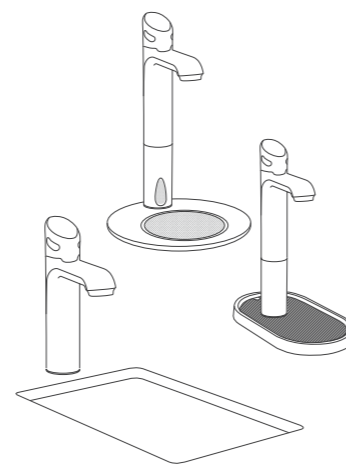

HydroTap Touch-Free Wave can be installed over sink or optional font.



Available now in Chrome. Contact Zip Water on availability on Touch-Free Wave in a Matte Black finish

Available water options & finishes:

FILTERED: <b>BOILING</b> CHILLED SPARKLING	UNFILTERED: <b>HOT &amp; COLD</b>	FILTERED: <b>BOILING</b> CHILLED	UNFILTERED: <b>HOT &amp; COLD</b>	FILTERED: <b>BOILING</b>	FILTERED: <b>HOT &amp; COLD</b>
5-In-1		4-In-1		3-In-1	

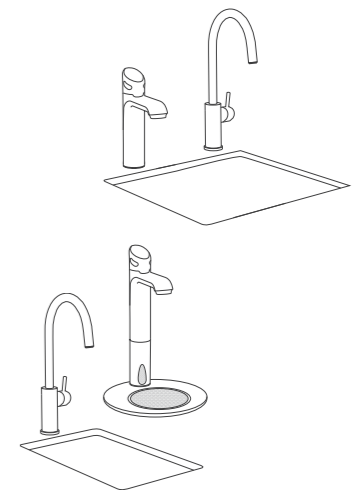

HydroTap Touch-Free Wave can be installed over sink or optional font



Available now in Chrome. Contact Zip Water on availability on Touch-Free Wave in a Matte Black finish



# Classic Plus

Featured product  
HydroTap Classic Plus installed over sink  
in Chrome finish



# Classic Plus with Mixer

Featured product  
HydroTap Classic Plus with Arc Mixer  
installed over sink in Matte Black finish



Available water options & finishes:

FILTERED: <b>BOILING</b> CHILLED SPARKLING	FILTERED: <b>BOILING</b> CHILLED	FILTERED: <b>CHILLED</b> SPARKLING	FILTERED: <b>CHILLED</b>	FILTERED: <b>BOILING</b> AMBIENT	FILTERED: <b>BOILING</b>

POPULAR

- Z00  
CHROME
- Z01  
BRUSHED  
CHROME
- Z03  
MATTE  
BLACK

PLATINUM

- Z05  
BRUSHED  
ROSE GOLD
- Z07  
BRUSHED  
GOLD
- Z09  
GUNMETAL
- Z11  
BRUSHED  
NICKEL

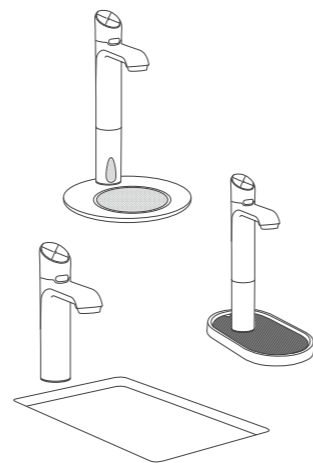

HydroTap Classic Plus can be installed over sink or optional font.

Available water options & finishes:

FILTERED: <b>BOILING</b> CHILLED SPARKLING	UNFILTERED: <b>HOT &amp; COLD</b>	FILTERED: <b>BOILING</b> CHILLED	UNFILTERED: <b>HOT &amp; COLD</b>	FILTERED: <b>BOILING</b>	FILTERED: <b>HOT &amp; COLD</b>
5-In-1		4-In-1		3-In-1	

POPULAR

- Z00  
CHROME
- Z01  
BRUSHED  
CHROME
- Z03  
MATTE  
BLACK

PLATINUM

- Z05  
BRUSHED  
ROSE GOLD
- Z07  
BRUSHED  
GOLD
- Z09  
GUNMETAL
- Z11  
BRUSHED  
NICKEL

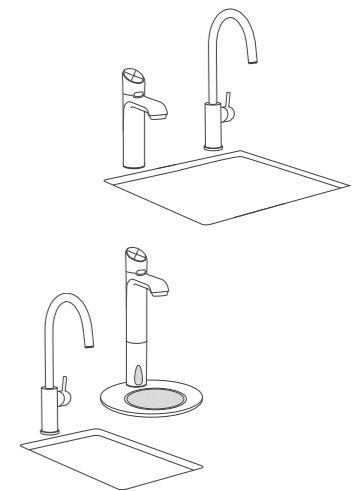

HydroTap Classic Plus can be installed over sink or optional font



# Classic

**Featured product**  
HydroTap Classic installed with optional font  
in Chrome finish



# Classic with Mixer

**Featured product**  
HydroTap Classic with Arc Mixer installed over sink  
in Chrome finish



**3.0** litres per minute

In accordance with AS/NZS 6400  
Licence No. 0086  
Zip Heaters (Aust) Pty Ltd

Classic Mixer

**5.5** litres per minute

In accordance with AS/NZS 6400  
Licence No. 0086  
Zip Heaters (Aust) Pty Ltd

Arc & Cube Mixer

Available water options & finishes:

FILTERED: <b>BOILING</b> CHILLED SPARKLING	FILTERED: <b>BOILING</b> CHILLED	FILTERED: <b>CHILLED</b> SPARKLING	FILTERED: <b>CHILLED</b>	FILTERED: <b>BOILING</b> AMBIENT	FILTERED: <b>BOILING</b>

POPULAR

Z00  
CHROME

Z01  
BRUSHED  
CHROME

Z03  
MATTE  
BLACK

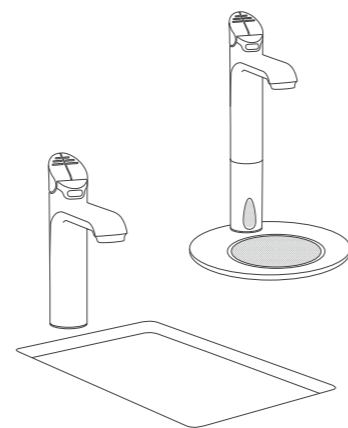

HydroTap Classic can be installed over sink or optional font

Available water options & finishes:

FILTERED: <b>BOILING</b> CHILLED SPARKLING	UNFILTERED: <b>HOT &amp; COLD</b>	FILTERED: <b>BOILING</b> CHILLED	UNFILTERED: <b>HOT &amp; COLD</b>	FILTERED: <b>BOILING</b>	FILTERED: <b>HOT &amp; COLD</b>
5-In-1		4-In-1		3-In-1	

POPULAR

Z00  
CHROME

Z01  
BRUSHED  
CHROME

Z03  
MATTE  
BLACK

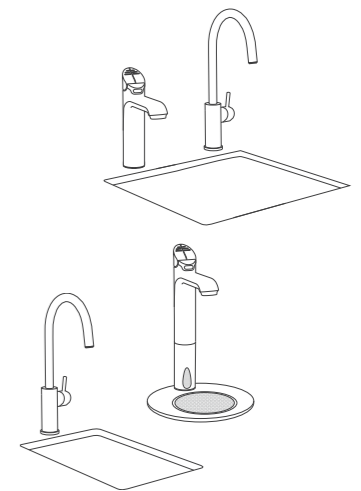

HydroTap Classic can be installed over sink or optional font



# Classic All-In-One

**Featured product**  
HydroTap Classic All-In-One installed over sink  
in Chrome finish



Available water options & finishes:

FILTERED: <b>BOILING</b> CHILLED SPARKLING	UNFILTERED: HOT & COLD	FILTERED: <b>BOILING</b> CHILLED	UNFILTERED: HOT & COLD

POPULAR

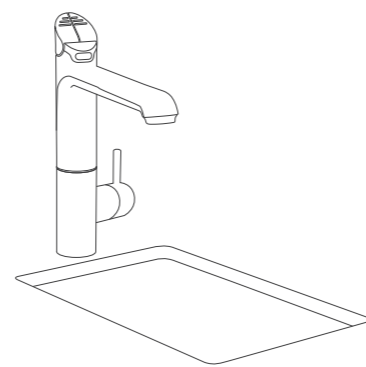
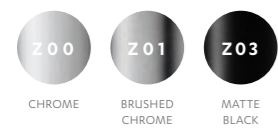

HydroTap Classic All-In-One can be installed over sink only

# Classic Industrial

**Featured product**  
HydroTap Classic Industrial installed on  
optional font in Chrome finish



Available water options & finishes:

FILTERED: <b>BOILING</b> CHILLED	FILTERED: <b>BOILING</b>

POPULAR



High strength vandal resistant tapered base

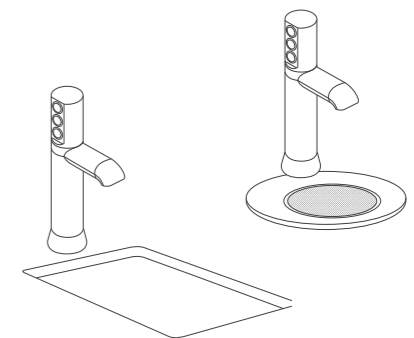

HydroTap Classic Industrial can be installed over sink or optional font



# Classic for accessibility

**Featured product**  
HydroTap Classic with accessibility levers installed with optional font in Chrome finish



## Making life simpler

Provide a truly accessible solution for those with limited mobility or impaired vision by selecting a Zip HydroTap model, supplied with oversized levers with braille covers.



Oversized colour coded braille tap levers

Available water options & finishes:

FILTERED: <b>BOILING</b> CHILLED SPARKLING	FILTERED: <b>BOILING</b> CHILLED	FILTERED: <b>CHILLED</b> SPARKLING	FILTERED: <b>CHILLED</b>	FILTERED: <b>BOILING</b> AMBIENT	FILTERED: <b>BOILING</b>

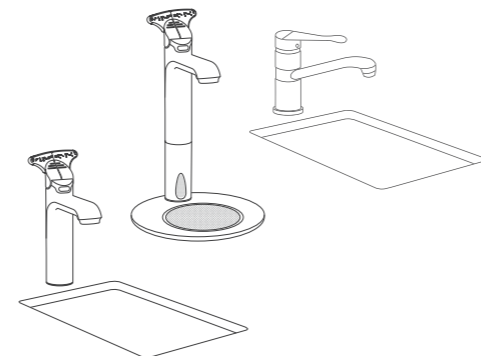

HydroTap Classic with accessibility levers can be installed over sink or optional font

POPULAR

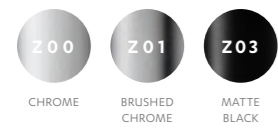

**Featured product** Zip HydroTap Classic Plus in Brushed Chrome finish



ZIP HYDROTAP COMMERCIAL

# Design range

GOOD  
DESIGN  
Award



**Featured product**  
HydroTap Arc in  
Brushed Nickel finish

Zip



## Arc

With an elegant curved shape, the Zip HydroTap Arc will complement any contemporary office or corporate space – available in boiling, chilled or sparkling water, or all three.



## Arc with Mixer

Designed for situations with only a cold water supply. Perfect for workplace kitchens that require a mixer tap and a Zip HydroTap in the same area.



## Cube

The stylish Zip HydroTap Cube is both a source of inspiration and a source of wellness – available in boiling, chilled or sparkling water, or all three in any combination.



## Cube with Mixer

Designed for situations with only a cold water supply. Perfect for workplace kitchens that require a mixer tap and a Zip HydroTap in the same area.



## Elite

Form meets function with the sophisticated and innovative Zip HydroTap Elite – available in boiling, chilled or sparkling water, or all three in any combination.



## Elite with Mixer

Designed for situations with only a cold water supply. Perfect for workplace kitchens that require a mixer tap and a Zip HydroTap in the same area.



# Arc

**Featured product**  
HydroTap Arc installed with optional font  
in Brushed Gold finish



# Arc with Mixer

**Featured product**  
HydroTap Arc installed with Arc Mixer  
in Chrome finish



Available water options & finishes:

FILTERED: <b>BOILING</b> CHILLED SPARKLING	FILTERED: <b>BOILING</b> CHILLED	FILTERED: <b>CHILLED</b> SPARKLING	FILTERED: <b>CHILLED</b>	FILTERED: <b>BOILING</b> AMBIENT	FILTERED: <b>BOILING</b>

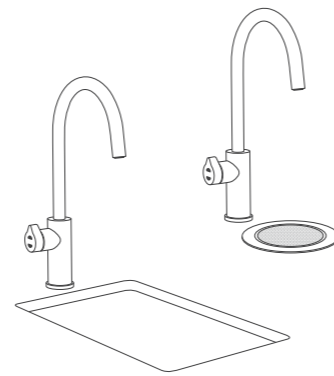

HydroTap Arc can be installed over sink or optional font

POPULAR

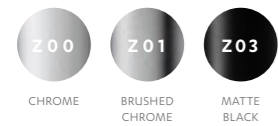

PLATINUM



Available water options & finishes:

FILTERED: <b>BOILING</b> CHILLED SPARKLING	UNFILTERED: <b>HOT &amp; COLD</b>	FILTERED: <b>BOILING</b> CHILLED	UNFILTERED: <b>HOT &amp; COLD</b>	FILTERED: <b>BOILING</b>	FILTERED: <b>HOT &amp; COLD</b>
5-In-1		4-In-1		3-In-1	

POPULAR

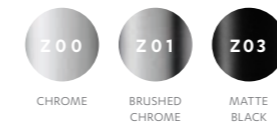

PLATINUM

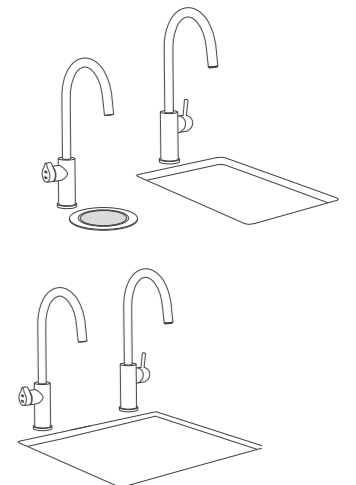

HydroTap Arc can be installed over sink or optional font

# Cube

**Featured product**  
HydroTap Cube installed with optional font  
in Gunmetal finish



Available water options & finishes:

<b>FILTERED:</b> <b>BOILING</b> <b>CHILLED</b> <b>SPARKLING</b>	<b>FILTERED:</b> <b>BOILING</b> <b>CHILLED</b>	<b>FILTERED:</b> <b>CHILLED</b> <b>SPARKLING</b>	<b>FILTERED:</b> <b>CHILLED</b>	<b>FILTERED:</b> <b>BOILING</b> <b>AMBIENT</b>	<b>FILTERED:</b> <b>BOILING</b>

POPULAR

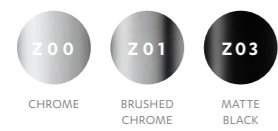

PLATINUM

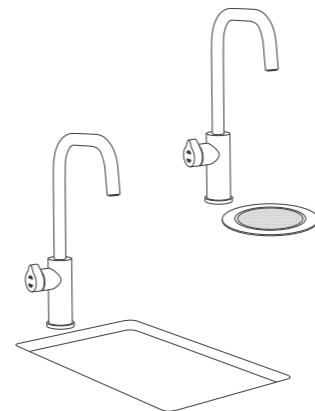

HydroTap Cube can be installed over sink or optional font

# Cube with Mixer

**Featured product**  
HydroTap Cube installed with Cube Mixer  
in Matte Black finish



Available water options & finishes:

<b>FILTERED:</b> <b>BOILING</b> <b>CHILLED</b> <b>SPARKLING</b>	<b>UNFILTERED:</b> <b>HOT &amp; COLD</b>	<b>FILTERED:</b> <b>BOILING</b> <b>CHILLED</b>	<b>UNFILTERED:</b> <b>HOT &amp; COLD</b>	<b>FILTERED:</b> <b>BOILING</b>	<b>FILTERED:</b> <b>HOT &amp; COLD</b>
5-In-1		4-In-1		3-In-1	

POPULAR

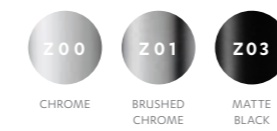

PLATINUM

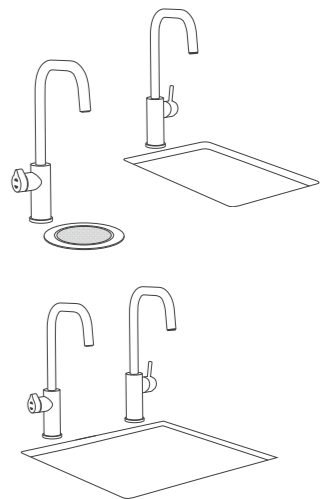

HydroTap Cube can be installed over sink or optional font



# Elite

**Featured product**  
HydroTap Elite installed with optional font  
in Chrome finish



# Elite with Mixer

**Featured product**  
HydroTap Elite with Arc Mixer installed over sink  
in Matte Black finish



Available water options & finishes:

FILTERED: <b>BOILING</b> CHILLED SPARKLING	FILTERED: <b>BOILING</b> CHILLED	FILTERED: <b>CHILLED</b> SPARKLING	FILTERED: <b>CHILLED</b>	FILTERED: <b>BOILING</b> AMBIENT	FILTERED: <b>BOILING</b>

POPULAR



PLATINUM

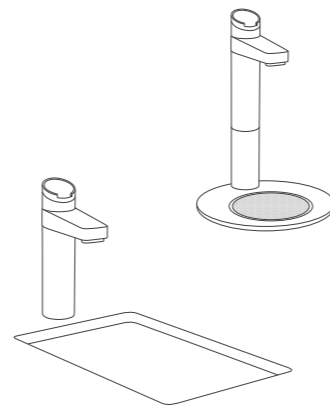

HydroTap Elite can be installed over sink or optional font

Available water options & finishes:

FILTERED: <b>BOILING</b> CHILLED SPARKLING	UNFILTERED: <b>HOT &amp; COLD</b>	FILTERED: <b>BOILING</b> CHILLED	UNFILTERED: <b>HOT &amp; COLD</b>	FILTERED: <b>BOILING</b>	FILTERED: <b>HOT &amp; COLD</b>
5-In-1		4-In-1		3-In-1	

POPULAR

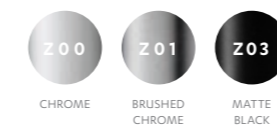

PLATINUM

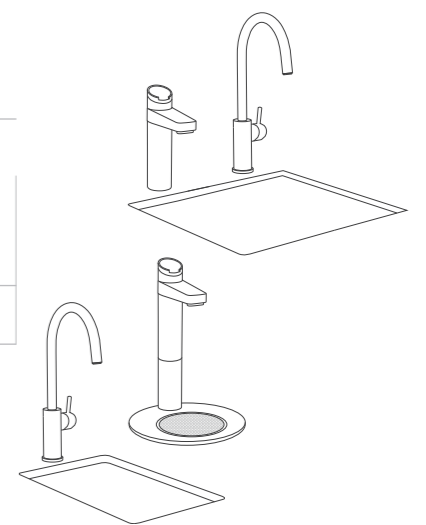

HydroTap Elite can be installed over sink or optional font



ZIP HYDROTAP COMMERCIAL

# Celsius range

GOOD  
DESIGN  
Award



## Celsius All-In-One

The ultimate in functionality, the All-In-One Celsius Arc is fitted over your sink and offers all five water types – filtered boiling, chilled and sparkling drinking water, plus unfiltered hot and cold water – from a single tap.



## Celsius Arc

The Celsius Arc delivers your choice of filtered boiling, or chilled, or chilled and sparkling water, plus unfiltered hot and cold water – from a single tap.



## Celsius Cube

The Celsius Cube delivers your choice of filtered boiling, or chilled, or chilled and sparkling water, plus unfiltered hot and cold water – from a single tap.



**Featured product**  
HydroTap Celsius Arc in  
Brushed Rose Gold finish

\*Celsius product needs a hot and cold water supply



# Celsius All-In-One

**Featured product**  
HydroTap Celsius All-In-One installed over sink  
in Chrome finish



\*This product needs a hot and cold water supply

Available water options & finishes:

<p>FILTERED: <b>BOILING</b> CHILLED SPARKLING</p>	<p>UNFILTERED: HOT &amp; COLD</p>	<p>FILTERED: <b>BOILING</b> CHILLED</p>	<p>UNFILTERED: HOT &amp; COLD</p>
---	---------------------------------------	---	---------------------------------------

POPULAR

- Z00**  
CHROME
- Z01**  
BRUSHED CHROME
- Z03**  
MATTE BLACK

PLATINUM

- Z05**  
BRUSHED ROSE GOLD
- Z07**  
BRUSHED GOLD
- Z09**  
GUNMETAL
- Z11**  
BRUSHED NICKEL

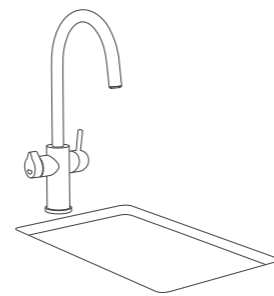

HydroTap Celsius All-In-One can be installed over sink only



**Featured product** HydroTap Celsius All-in-One Arc in Chrome finish

# Celsius Arc

**Featured product**  
HydroTap Celsius Arc installed over sink  
in Brushed Rose Gold finish



\*This product needs a hot and cold water supply

Available water options & finishes:

<b>FILTERED:</b> <b>CHILLED SPARKLING</b>	<b>UNFILTERED:</b> <b>HOT &amp; COLD</b>	<b>FILTERED:</b> <b>CHILLED</b>	<b>UNFILTERED:</b> <b>HOT &amp; COLD</b>	<b>FILTERED:</b> <b>BOILING</b>	<b>FILTERED:</b> <b>HOT &amp; COLD</b>

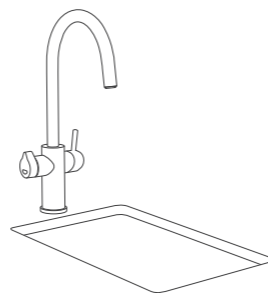

HydroTap Celsius Arc can be installed over sink only

POPULAR

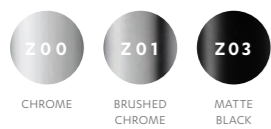

PLATINUM



# Celsius Cube

**Featured product**  
HydroTap Celsius Cube installed over sink  
in Brushed Chrome finish



\*This product needs a hot and cold water supply

Available water options & finishes:

<b>FILTERED:</b> <b>CHILLED SPARKLING</b>	<b>UNFILTERED:</b> <b>HOT &amp; COLD</b>	<b>FILTERED:</b> <b>CHILLED</b>	<b>UNFILTERED:</b> <b>HOT &amp; COLD</b>	<b>FILTERED:</b> <b>BOILING</b>	<b>FILTERED:</b> <b>HOT &amp; COLD</b>

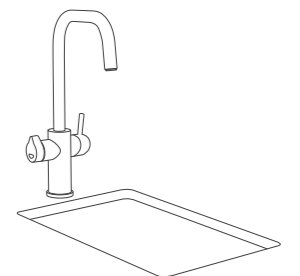

HydroTap Celsius Cube can be installed over sink only

POPULAR



PLATINUM





# Micro

**Featured product**  
HydroTap Micro installed over sink  
in Chrome finish



## Commercial HydroTap

CLASSIC PLUS



ORDER CODE	NO. PEOPLE	MODEL	WATER OPTIONS	CUPS PER HOUR	GLASSES PER HOUR	SIZE* H x W x D (mm)
H55760Z00AU	20	BCS	Filtered Boiling, Filtered Chilled, Sparkling	100	75	333 x 339 x 460
H55762Z00AU	60			160	175	333 x 395 x 464
H55763Z00AU	100			240*	175	333 x 395 x 464
H55702Z00AU	20	BC	Filtered Boiling, Filtered Chilled	100	75	333 x 280 x 455
H55703Z00AU	40			160	125	333 x 395 x 464
H55704Z00AU	60			160	175	333 x 395 x 464
H55705Z00AU	100			240*	175	333 x 395 x 464
H55708Z00AU	60	BA	Filtered Boiling, Ambient	160	-	333 x 280 x 313
H55709Z00AU	100			240*	-	333 x 280 x 313
H55706Z00AU	60	B	Filtered Boiling	160	-	333 x 280 x 313
H55707Z00AU	100			240*	-	333 x 280 x 313
H55765Z00AU	100	CS	Filtered Chilled, Sparkling	-	150	333 x 280 x 480
H55710Z00AU	40	C	Filtered Chilled	-	125	333 x 280 x 476
H55711Z00AU	100			-	150	333 x 280 x 476

CLASSIC PLUS WITH CLASSIC MIXER

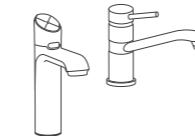

H55675Z00AU	60	BCSHA	Filtered Boiling, Filtered Chilled, Sparkling, Hot & Cold	160	175	333 x 395 x 464
H55676Z00AU	100			240*	175	333 x 395 x 464
H55621Z00AU	20	BCHA	Filtered Boiling, Filtered Chilled, Hot & Cold	100	75	333 x 280 x 455
H55622Z00AU	40			160	125	333 x 395 x 464
H55623Z00AU	60			160	175	333 x 395 x 464
H55624Z00AU	100			240*	175	333 x 395 x 464

Available water options & finishes:

FILTERED: BOILING CHILLED	FILTERED: BOILING

POPULAR

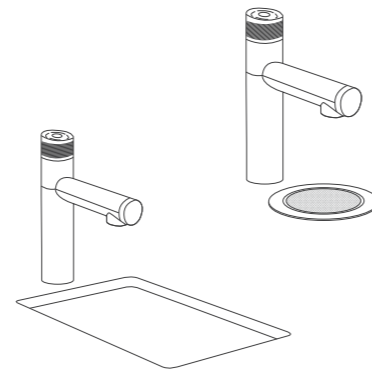

HydroTap Micro can be installed over sink or optional front

AVAILABLE IN:

POPULAR

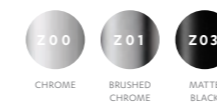

PLATINUM



Order code listed above is for chrome finish. To select a different finish, replace Z00 with the relevant colour code. For example, HydroTap G5 BCS20 Classic Plus in a Matte Black finish use code H51760Z03AU.

KEY TO ICONS

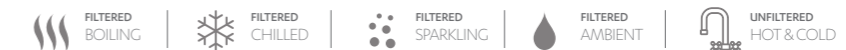

\*240 boiling cup per hour models include additional Booster and require 2 x 10 amp power GPOs. Refer to zipwater.com for full specification details.

Size relates to command centre - revert to installation diagram for clearance and ventilation.

Class size is 200ml and cup size 167ml.

'Ambient' describes the temperature of the water where there is no additional heating or chilling to the incoming cold water supply.

# Commercial HydroTap

CLASSIC PLUS WITH ARC MIXER

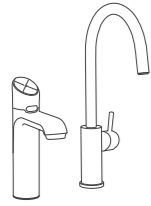

ORDER CODE	NO. PEOPLE	MODEL	WATER OPTIONS	CUPS PER HOUR	GLASSES PER HOUR	SIZE* H x W x D (mm)
H55875Z00AU	60	BCSHA		160	175	333 x 395 x 464
H55876Z00AU	100			240*	175	333 x 395 x 464
H55821Z00AU	20	BCHA		100	75	333 x 280 x 455
H55822Z00AU	40			160	125	333 x 395 x 464
H55823Z00AU	60			160	175	333 x 395 x 464
H55824Z00AU	100			240*	175	333 x 395 x 464
H55856Z00AU	60	BHA		160	-	333 x 280 x 313
H55857Z00AU	100			240*	-	333 x 280 x 313

CLASSIC PLUS WITH CUBE MIXER

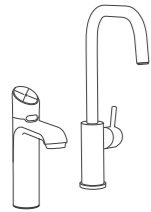

ORDER CODE	NO. PEOPLE	MODEL	WATER OPTIONS	CUPS PER HOUR	GLASSES PER HOUR	SIZE* H x W x D (mm)
H55975Z00AU	60	BCSHA		160	175	333 x 395 x 464
H55976Z00AU	100			240*	175	333 x 395 x 464
H55921Z00AU	20	BCHA		100	75	333 x 280 x 455
H55922Z00AU	40			160	125	333 x 395 x 464
H55923Z00AU	60			160	175	333 x 395 x 464
H55924Z00AU	100			240*	175	333 x 395 x 464
H55956Z00AU	60	BHA		160	-	333 x 280 x 313
H55957Z00AU	100			240*	-	333 x 280 x 313

AVAILABLE IN:



Order code listed above is for chrome finish. To select a different finish, replace Z00 with the relevant colour code. For example, HydroTap GS BCSHA60 Classic Plus in a Matte Black finish use code H55875Z03AU.



\*240 boiling cup per hour models include additional Booster and require 2 x 10 amp power GPOs. Refer to zipwater.com for full specification details.

Size relates to command centre - revert to installation diagram for clearance and ventilation.

Glass size is 200ml and cup size 167ml.

'Ambient' describes the temperature of the water where there is no additional heating or chilling to the incoming cold water supply.

TOUCH-FREE WAVE



ORDER CODE	NO. PEOPLE	MODEL	WATER OPTIONS	CUPS PER HOUR	GLASSES PER HOUR	SIZE* H x W x D (mm)
H5W760Z00AU	20	BCS		100	75	333 x 339 x 460
H5W762Z00AU	60			160	175	333 x 395 x 464
H5W763Z00AU	100			240*	175	333 x 395 x 464
H5W702Z00AU	20	BC		100	75	333 x 280 x 455
H5W703Z00AU	40			160	125	333 x 395 x 464
H5W704Z00AU	60			160	175	333 x 395 x 464
H5W705Z00AU	100			240*	175	333 x 395 x 464
H5W708Z00AU	60	BA		160	-	333 x 280 x 313
H5W706Z00AU	60	B		160	-	333 x 280 x 313
H5W707Z00AU	100			240*	-	333 x 280 x 313
H5W765Z00AU	100	CS		-	150	333 x 280 x 480
H5W710Z00AU	40	C		-	125	333 x 280 x 476
H5W711Z00AU	100			-	150	333 x 280 x 476

TOUCH-FREE WAVE WITH CLASSIC MIXER

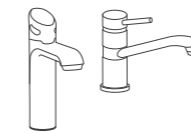

H5W675Z00AU	60	BCSHA		160	175	333 x 395 x 464
H5W676Z00AU	100			240*	175	333 x 395 x 464
H5W621Z00AU	20	BCHA		100	75	333 x 280 x 455
H5W622Z00AU	40			160	125	333 x 395 x 464
H5W623Z00AU	60			160	175	333 x 395 x 464
H5W624Z00AU	100			240*	175	333 x 395 x 464

AVAILABLE IN:



Order code listed above is for chrome finish.



\*240 boiling cup per hour models include additional Booster and require 2 x 10 amp power GPOs. Refer to zipwater.com for full specification details.

Size relates to command centre - revert to installation diagram for clearance and ventilation.

Glass size is 200ml and cup size 167ml.

'Ambient' describes the temperature of the water where there is no additional heating or chilling to the incoming cold water supply.



# Commercial HydroTap

## TOUCH-FREE WAVE WITH ACCESSIBLE MIXER

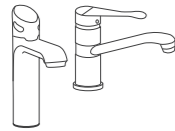

ORDER CODE	NO. PEOPLE	MODEL	WATER OPTIONS	CUPS PER HOUR	GLASSES PER HOUR	SIZE* H x W x D (mm)
H5WD21Z00AU	20	BCHA		100	75	333 x 280 x 455
H5WD22Z00AU	40			160	125	333 x 395 x 464
H5WD23Z00AU	60			160	175	333 x 395 x 464
H5WD24Z00AU	100			240*	175	333 x 395 x 464

## TOUCH-FREE WAVE WITH ARC MIXER

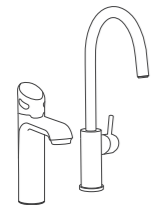

ORDER CODE	NO. PEOPLE	MODEL	WATER OPTIONS	CUPS PER HOUR	GLASSES PER HOUR	SIZE* H x W x D (mm)
H5W875Z00AU	60	BCSHA		160	175	333 x 395 x 464
H5W876Z00AU	100			240*	175	333 x 395 x 464
H5W821Z00AU	20	BCHA		100	75	333 x 280 x 455
H5W822Z00AU	40			160	125	333 x 395 x 464
H5W823Z00AU	60			160	175	333 x 395 x 464
H5W824Z00AU	100			240*	175	333 x 395 x 464

## TOUCH-FREE WAVE WITH CUBE MIXER

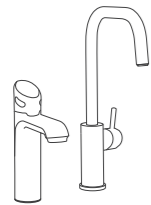

ORDER CODE	NO. PEOPLE	MODEL	WATER OPTIONS	CUPS PER HOUR	GLASSES PER HOUR	SIZE* H x W x D (mm)
H5W975Z00AU	60	BCSHA		160	175	333 x 395 x 464
H5W976Z00AU	100			240*	175	333 x 395 x 464
H5W921Z00AU	20	BCHA		100	75	333 x 280 x 455
H5W922Z00AU	40			160	125	333 x 395 x 464
H5W923Z00AU	60			160	175	333 x 395 x 464
H5W924Z00AU	100			240*	175	333 x 395 x 464

### AVAILABLE IN:

#### POPULAR



CHROME

Order code listed above is for chrome finish.

#### KEY TO ICONS

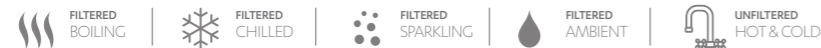

\*240 boiling cup per hour models include additional Booster and require 2 x 10 amp power GPOs. Refer to zipwater.com for full specification details.

Size relates to command centre - revert to installation diagram for clearance and ventilation.

Glass size is 200ml and cup size 167ml.

'Ambient' describes the temperature of the water where there is no additional heating or chilling to the incoming cold water supply.

## CLASSIC



ORDER CODE	NO. PEOPLE	MODEL	WATER OPTIONS	CUPS PER HOUR	GLASSES PER HOUR	SIZE* H x W x D (mm)
H51760Z00AU	20	BCS		100	75	333 x 339 x 460
H51762Z00AU	60			160	175	333 x 395 x 464
H51763Z00AU	100			240*	175	333 x 395 x 464
H51702Z00AU	20	BC		100	75	333 x 280 x 455
H51703Z00AU	40			160	125	333 x 395 x 464
H51704Z00AU	60			160	175	333 x 395 x 464
H51705Z00AU	100			240*	175	333 x 395 x 464
H51708Z00AU	60	BA		160	-	333 x 280 x 313
H51709Z00AU	100			240*	-	333 x 280 x 313
H51706Z00AU	60	B		160	-	333 x 280 x 313
H51707Z00AU	100			240*	-	333 x 280 x 313
H51765Z00AU	100	CS		-	150	333 x 280 x 480
H51710Z00AU	40	C		-	125	333 x 280 x 476
H51711Z00AU	100			-	150	333 x 280 x 476

## CLASSIC WITH CLASSIC MIXER

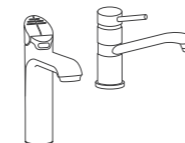

H51675Z00AU	60	BCSHA		160	175	333 x 395 x 464
H51676Z00AU	100			240*	175	333 x 395 x 464
H51621Z00AU	20	BCHA		100	75	333 x 280 x 455
H51622Z00AU	40			160	125	333 x 395 x 464
H51623Z00AU	60			160	175	333 x 395 x 464
H51624Z00AU	100			240*	175	333 x 395 x 464
H51656Z00AU	60	BHA		160	-	333 x 280 x 313
H51657Z00AU	100			240*	-	333 x 280 x 313

### AVAILABLE IN:

#### POPULAR



CHROME BRUSHED CHROME MATTE BLACK

#### PLATINUM



BRUSHED ROSE GOLD BRUSHED GOLD GUNMETAL BRUSHED NICKEL

Order code listed above is for chrome finish. To select a different finish, replace Z00 with the relevant colour code. For example, HydroTap G5 BCS20 Classic in a Matte Black finish use code H51760Z03AU.

#### KEY TO ICONS

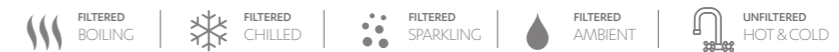

\*240 boiling cup per hour models include additional Booster and require 2 x 10 amp power GPOs. Refer to zipwater.com for full specification details.

Size relates to command centre - revert to installation diagram for clearance and ventilation.

Glass size is 200ml and cup size 167ml.

'Ambient' describes the temperature of the water where there is no additional heating or chilling to the incoming cold water supply.

# Commercial HydroTap

## CLASSIC WITH ARC MIXER

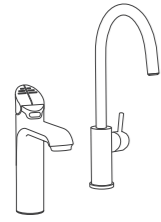

ORDER CODE	NO. PEOPLE	MODEL	WATER OPTIONS	CUPS PER HOUR	GLASSES PER HOUR	SIZE* H x W x D (mm)
H51875Z00AU	60	BCSHA		160	175	333 x 395 x 464
H51876Z00AU	100			240*	175	333 x 395 x 464
H51821Z00AU	20	BCHA		100	75	333 x 280 x 455
H51822Z00AU	40			160	125	333 x 395 x 464
H51823Z00AU	60			160	175	333 x 395 x 464
H51824Z00AU	100			240*	175	333 x 395 x 464
H51856Z00AU	60	BHA		160	-	333 x 280 x 313
H51857Z00AU	100			240*	-	333 x 280 x 313

## CLASSIC WITH CUBE MIXER

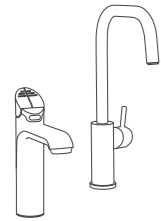

H51975Z00AU	60	BCSHA		160	175	333 x 395 x 464
H51976Z00AU	100			240*	175	333 x 395 x 464
H51921Z00AU	20	BCHA		100	75	333 x 280 x 455
H51922Z00AU	40			160	125	333 x 395 x 464
H51923Z00AU	60			160	175	333 x 395 x 464
H51924Z00AU	100			240*	175	333 x 395 x 464
H51956Z00AU	60	BHA		160	-	333 x 280 x 313
H51957Z00AU	100			240*	-	333 x 280 x 313

## CLASSIC ALL-IN-ONE

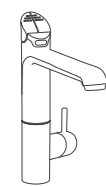

H5A775Z00AU	60	BCSHA		160	175	333 x 395 x 464
H5A776Z00AU	100			240*	175	333 x 395 x 464
H5A722Z00AU	40	BCHA		160	125	333 x 395 x 464
H5A723Z00AU	60			160	175	333 x 395 x 464
H5A724Z00AU	100			240*	175	333 x 395 x 464

### AVAILABLE IN:

#### POPULAR



#### PLATINUM



Order code listed above is for chrome finish. To select a different finish, replace Z00 with the relevant colour code. For example, HydroTap GS BCSHA60 Classic with Arc Mixer in a Matte Black finish use code H51875Z03AU.

#### KEY TO ICONS

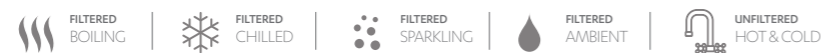

\*240 boiling cup per hour models include additional Booster and require 2 x 10 amp power GPOs. Refer to zipwater.com for full specification details.

Size relates to command centre - revert to installation diagram for clearance and ventilation.

Glass size is 200ml and cup size 167ml.

'Ambient' describes the temperature of the water where there is no additional heating or chilling to the incoming cold water supply.

## CLASSIC INDUSTRIAL SIDE TOUCH

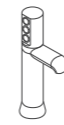

ORDER CODE	NO. PEOPLE	MODEL	WATER OPTIONS	CUPS PER HOUR	GLASSES PER HOUR	SIZE* H x W x D (mm)
H5J703Z00AU	40	BC		160	125	333 x 395 x 464
H5J704Z00AU	60			160	175	333 x 395 x 464
H5J705Z00AU	100			240*	175	333 x 395 x 464

## CLASSIC INDUSTRIAL TOP TOUCH



H5I703Z00AU	40	BC		160	125	333 x 395 x 464
H5I704Z00AU	60			160	175	333 x 395 x 464
H5I705Z00AU	100			240*	175	333 x 395 x 464

## MICRO

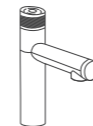

M1005AU	10	BC		90	60	340 x 180 x 502
M1001AU	10	B		90	-	340 x 180 x 270

### AVAILABLE IN:

#### POPULAR

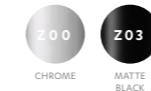

Order code listed above is for chrome finish.

#### KEY TO ICONS

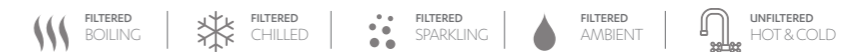

\*240 boiling cup per hour models include additional Booster and require 2 x 10 amp power GPOs. Refer to zipwater.com for full specification details.

Size relates to command centre - revert to installation diagram for clearance and ventilation.

Glass size is 200ml and cup size 167ml.

Industrial is available in only Chrome finish.

'Ambient' describes the temperature of the water where there is no additional heating or chilling to the incoming cold water supply.



# Commercial HydroTap

ARC

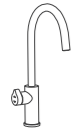

ORDER CODE	NO. PEOPLE	MODEL	WATER OPTIONS	CLIPS PER HOUR		SIZE* H x W x D (mm)
				100	GLASSES PER HOUR	
H52760Z00AU	20	BCS		100	75	333 x 339 x 460
H52762Z00AU	60			160	175	333 x 395 x 464
H52763Z00AU	100			240*	175	333 x 395 x 464
H52702Z00AU	20	BC		100	75	333 x 280 x 455
H52703Z00AU	40			160	125	333 x 395 x 464
H52704Z00AU	60			160	175	333 x 395 x 464
H52705Z00AU	100			240*	175	333 x 395 x 464
H52708Z00AU	60	BA		160	-	333 x 280 x 313
H52709Z00AU	100			240*	-	333 x 280 x 313
H52706Z00AU	60	B		160	-	333 x 280 x 313
H52707Z00AU	100			240*	-	333 x 280 x 313
H52765Z00AU	100	CS		-	150	333 x 280 x 480
H52710Z00AU	40	C		-	125	333 x 280 x 476
H52711Z00AU	100			-	150	333 x 280 x 476

CUBE

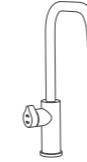

ORDER CODE	NO. PEOPLE	MODEL	WATER OPTIONS	CLIPS PER HOUR		SIZE* H x W x D (mm)
				100	GLASSES PER HOUR	
H53760Z00AU	20	BCS		100	75	333 x 339 x 460
H53762Z00AU	60			160	175	333 x 395 x 464
H53763Z00AU	100			240*	175	333 x 395 x 464
H53702Z00AU	20	BC		100	75	333 x 280 x 455
H53703Z00AU	40			160	125	333 x 395 x 464
H53704Z00AU	60			160	175	333 x 395 x 464
H53705Z00AU	100			240*	175	333 x 395 x 464
H53708Z00AU	60	BA		160	-	333 x 280 x 313
H53709Z00AU	100			240*	-	333 x 280 x 313
H53706Z00AU	60	B		160	-	333 x 280 x 313
H53707Z00AU	100			240*	-	333 x 280 x 313
H53765Z00AU	100	CS		-	150	333 x 280 x 480
H53710Z00AU	40	C		-	125	333 x 280 x 476
H53711Z00AU	100			-	150	333 x 280 x 476

ARC WITH ARC MIXER



H52875Z00AU	60	BCSHA		160	175	333 x 395 x 464
H52876Z00AU	100			240*	175	333 x 395 x 464
H52822Z00AU	40	BCHA		160	125	333 x 395 x 464
H52823Z00AU	60			160	175	333 x 395 x 464
H52824Z00AU	100			240*	175	333 x 395 x 464
H52856Z00AU	60	BHA		160	-	333 x 280 x 313
H52857Z00AU	100			240*	-	333 x 280 x 313

CUBE WITH CUBE MIXER

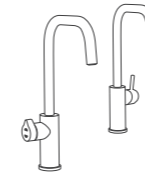

H53975Z00AU	60	BCSHA		160	175	333 x 395 x 464
H53976Z00AU	100			240*	175	333 x 395 x 464
H53922Z00AU	40	BCHA		160	125	333 x 395 x 464
H53923Z00AU	60			160	175	333 x 395 x 464
H53924Z00AU	100			240*	175	333 x 395 x 464
H53956Z00AU	60	BHA		160	-	333 x 280 x 313
H53957Z00AU	100			240*	-	333 x 280 x 313

AVAILABLE IN:



Order code listed above is for chrome finish. To select a different finish, replace Z00 with the relevant colour code. For example, HydroTap GS BCS20 Arc in a Matte Black finish use code H52760Z03AU.



\*240 boiling cup per hour models include additional Booster and require 2 x 10 amp power GPOs. Refer to zipwater.com for full specification details.  
Size relates to command centre - revert to installation diagram for clearance and ventilation.  
Glass size is 200ml and cup size 167ml.  
'Ambient' describes the temperature of the water where there is no additional heating or chilling to the incoming cold water supply.

AVAILABLE IN:



Order code listed above is for chrome finish. To select a different finish, replace Z00 with the relevant colour code. For example, HydroTap GS BCS20 Cube in a Matte Black finish use code H53760Z03AU.



\*240 boiling cup per hour models include additional Booster and require 2 x 10 amp power GPOs. Refer to zipwater.com for full specification details.  
Size relates to command centre - revert to installation diagram for clearance and ventilation.  
Glass size is 200ml and cup size 167ml.  
'Ambient' describes the temperature of the water where there is no additional heating or chilling to the incoming cold water supply.

# Commercial HydroTap

ELITE

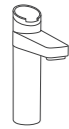

ORDER CODE	NO. PEOPLE	MODEL	WATER OPTIONS	CUPS PER HOUR	GLASSES PER HOUR	SIZE* H x W x D (mm)
H54760Z00AU	20	BCS		100	75	333 x 339 x 460
H54762Z00AU	60			160	175	333 x 395 x 464
H54763Z00AU	100			240*	175	333 x 395 x 464
H54702Z00AU	20	BC		100	75	333 x 280 x 455
H54703Z00AU	40			160	125	333 x 395 x 464
H54704Z00AU	60			160	175	333 x 395 x 464
H54705Z00AU	100			240*	175	333 x 395 x 464
H54708Z00AU	60	BA		160	-	333 x 280 x 313
H54707Z00AU	100			240*	-	333 x 280 x 313
H54706Z00AU	60	B		160	-	333 x 280 x 313
H54707Z00AU	100			240*	-	333 x 280 x 313
H54765Z00AU	100	CS		-	150	333 x 280 x 480
H54710Z00AU	40	C		-	125	333 x 280 x 476
H54711Z00AU	100			-	150	333 x 280 x 476

ELITE WITH CLASSIC MIXER

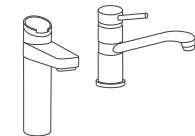

H54675Z00AU	60	BCSHA		160	175	333 x 395 x 464
H54676Z00AU	100			240*	175	333 x 395 x 464
H54622Z00AU	40	BCHA		160	125	333 x 395 x 464
H54623Z00AU	60			160	175	333 x 395 x 464
H54624Z00AU	100			240*	175	333 x 395 x 464
H54656Z00AU	60	BHA		160	-	333 x 280 x 313
H54657Z00AU	100			240*	-	333 x 280 x 313

AVAILABLE IN:



Order code listed above is for chrome finish. To select a different finish, replace Z00 with the relevant colour code. For example, HydroTap G5 BCS20 Elite in a Matte Black finish use code H54760Z03AU.

KEY TO ICONS

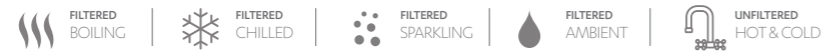

\*240 boiling cup per hour models include additional Booster and require 2 x 10 amp power GPOs. Refer to zipwater.com for full specification details.

Size relates to command centre - revert to installation diagram for clearance and ventilation.

Glass size is 200ml and cup size 167ml.

'Ambient' describes the temperature of the water where there is no additional heating or chilling to the incoming cold water supply.

ELITE WITH ARC MIXER

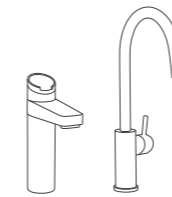

ORDER CODE	NO. PEOPLE	MODEL	WATER OPTIONS	CUPS PER HOUR	GLASSES PER HOUR	SIZE* H x W x D (mm)
H54875Z00AU	60	BCSHA		160	175	333 x 395 x 464
H54876Z00AU	100			240*	175	333 x 395 x 464
H54822Z00AU	40			BCHA		160
H54823Z00AU	60	160	175			333 x 395 x 464
H54824Z00AU	100	240*	175			333 x 395 x 464
H54856Z00AU	60	BHA		160	-	333 x 280 x 313
H54857Z00AU	100			240*	-	333 x 280 x 313

ELITE WITH CUBE MIXER

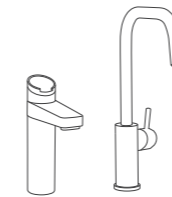

ORDER CODE	NO. PEOPLE	MODEL	WATER OPTIONS	CUPS PER HOUR	GLASSES PER HOUR	SIZE* H x W x D (mm)
H54975Z00AU	60	BCSHA		160	175	333 x 395 x 464
H54976Z00AU	100			240*	175	333 x 395 x 464
H54922Z00AU	40	BCHA		160	125	333 x 395 x 464
H54923Z00AU	60			160	175	333 x 395 x 464
H54924Z00AU	100			240*	175	333 x 395 x 464
H54956Z00AU	60	BHA		160	-	333 x 280 x 313
H54957Z00AU	100			240*	-	333 x 280 x 313

AVAILABLE IN:



Order code listed above is for chrome finish. To select a different finish, replace Z00 with the relevant colour code. For example, HydroTap G5 BCSHA60 5-In-1 Elite tap with Arc Mixer in a Matte Black finish use code H54875Z03AU.

KEY TO ICONS

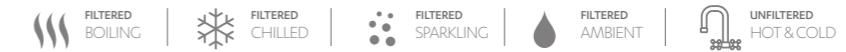

\*240 boiling cup per hour models include additional Booster and require 2 x 10 amp power GPOs. Refer to zipwater.com for full specification details.

Size relates to command centre - revert to installation diagram for clearance and ventilation.

Glass size is 200ml and cup size 167ml.

'Ambient' describes the temperature of the water where there is no additional heating or chilling to the incoming cold water supply.



# Commercial HydroTap

CELSIUS ALL-IN-ONE\*\*

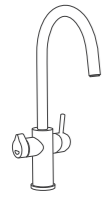

ORDER CODE	NO. PEOPLE	MODEL	WATER OPTIONS	CUPS PER HOUR	GLASSES PER HOUR	SIZE* H x W x D (mm)
H57760Z00AU	20	BCSHA		100	75	333 x 339 x 460
H57762Z00AU	60			160	175	333 x 395 x 464
H57763Z00AU	100			240*	175	333 x 395 x 464
H57702Z00AU	20	BCHA		100	75	333 x 280 x 455
H57703Z00AU	40			160	125	333 x 395 x 464
H57704Z00AU	60			160	175	333 x 395 x 464
H57705Z00AU	100			240	175	333 x 395 x 464

CELSIUS ARC\*\*

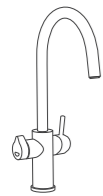

ORDER CODE	NO. PEOPLE	MODEL	WATER OPTIONS	CUPS PER HOUR	GLASSES PER HOUR	SIZE* H x W x D (mm)
H58706Z00AU	60	B		160	-	333 x 280 x 313
H58707Z00AU	100			240*	-	333 x 280 x 313
H58765Z00AU	100	CS		-	150	333 x 280 x 480
H58711Z00AU	100	C		-	150	333 x 280 x 476

CELSIUS CUBE\*\*

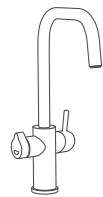

MODEL CODE	NO. PEOPLE	MODEL	WATER OPTIONS	CUPS PER HOUR	GLASSES PER HOUR	SIZE* H x W x D (mm)
H59706Z00AU	60	B		160	-	333 x 280 x 313
H59707Z00AU	100			240*	-	333 x 280 x 313
H59765Z00AU	100	CS		-	150	333 x 280 x 480
H59711Z00AU	100	C		-	150	333 x 280 x 476

\*\*Celsius products require a hot and cold water supply

AVAILABLE IN:

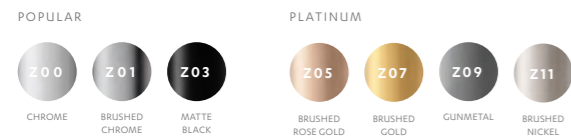

Order code listed above is for chrome finish. To select a different finish, replace Z00 with the relevant colour code. For example, HydroTap G5 BCSHA20 Elite in a Matte Black finish use code H57760Z03AU.

KEY TO ICONS

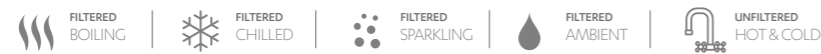

\*240 boiling cup per hour models include additional Booster and require 2 x 10 amp power GPOs. Refer to zipwater.com for full specification details.

Size relates to command centre - revert to installation diagram for clearance and ventilation.

Glass size is 200ml and cup size 167ml.

'Ambient' describes the temperature of the water where there is no additional heating or chilling to the incoming cold water supply.

# Technical information

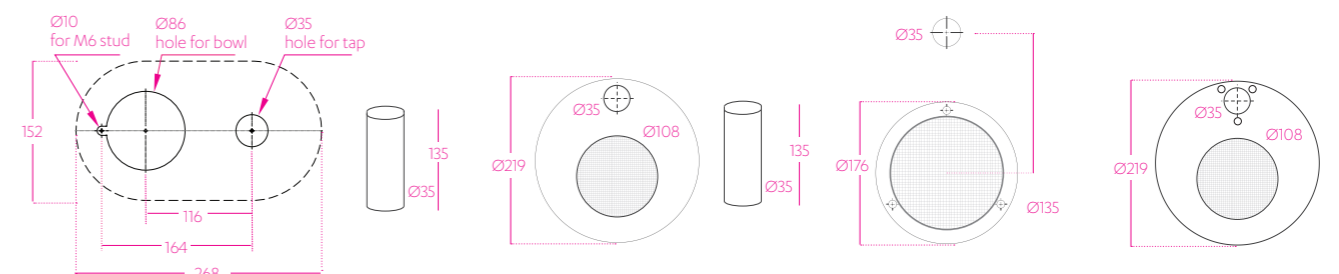
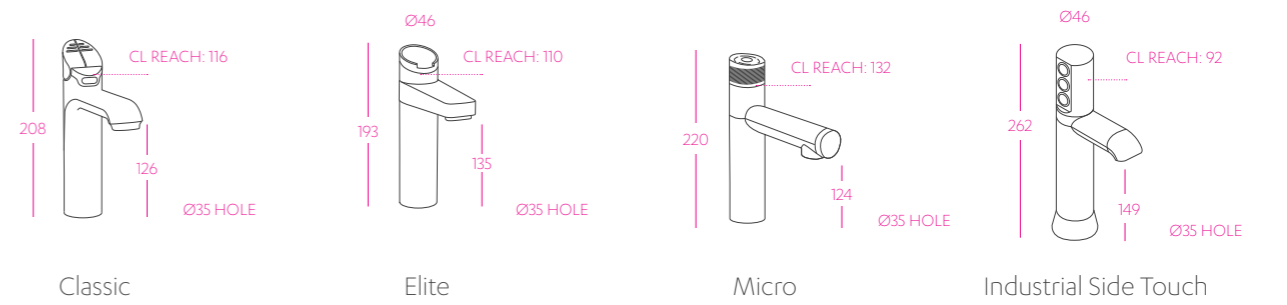
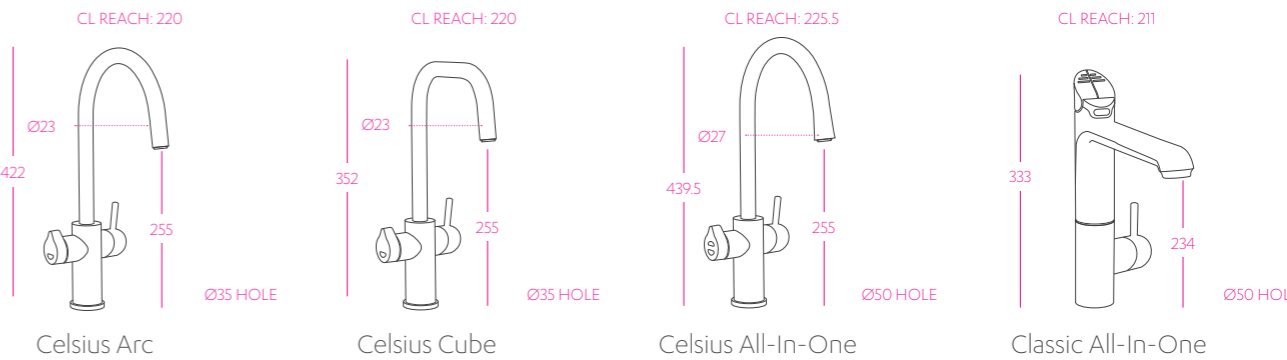
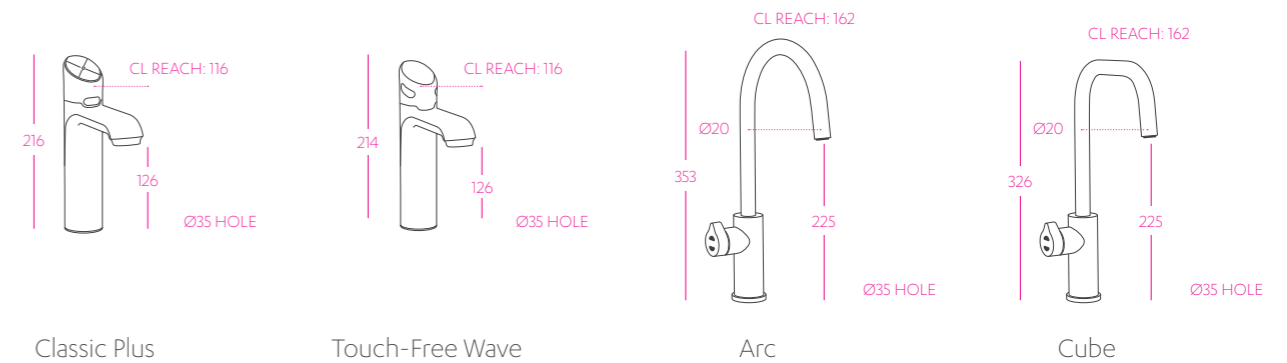

**95258** Zip font raised  
Suits any current model Zip HydroTap Classic, Classic Plus, Touch-Free Wave, MiniBoil Classic and Elite

**90915** Zip font kit  
Suits any current model Zip HydroTap Classic, Classic Plus, Touch-Free Wave, MiniBoil Classic and Elite

**93441** Font for HydroTap Arc and Cube

**90869** Font for Industrial

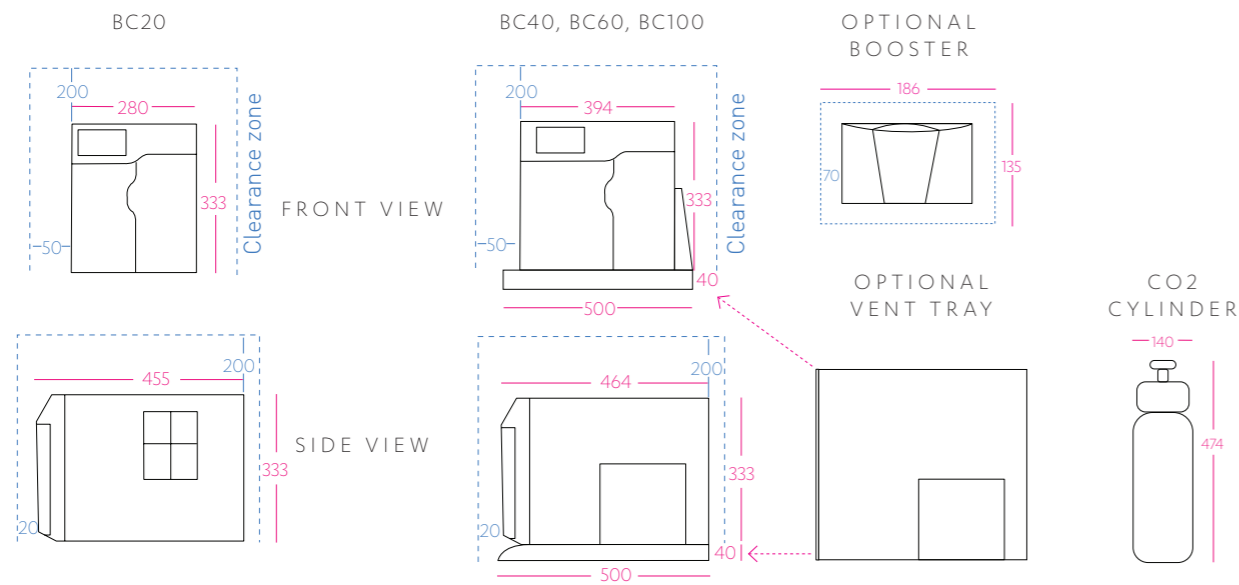

For full installation details please refer to the installation instructions which can be found at [zipwater.com](http://zipwater.com). Be sure to allow additional space required if installing a sparkling model with CO2 cylinder.



Image shows BC40 command center installed with optional vent tray 93540

## Accessories



**90915**  
Zip font kit

Suits any current model Zip HydroTap Classic, Classic Plus, Touch-Free Wave, Miniboil Classic and Elite



**93441**  
Zip stand alone font kit

Suits any current model HydroTap Arc or Cube. Does not include extension



**95258**  
Zip font raised

Suits any current model Zip HydroTap Classic, Classic Plus, Touch-Free Wave, Miniboil Classic and Elite



**91564**  
Zip BCS accessibility lever

Available in various configurations to suit your needs. Compatible with Classic HydroTap only



**91560**  
Zip BC accessibility lever

## Installation accessories



**93540**  
Zip vent tray

Suits any current commercial Zip HydroTap BC or BCS



**93541**  
Zip vent tray

Suits any current commercial Zip HydroTap C or CS



**93156**  
Zip dual exhaust fan

Suits any current commercial Zip HydroTap with chilled water











1800 947 827

**zipwater.com**