

# VINTEC



THE COLLECTION

# Designed for wine lovers, by wine lovers.

Great wines are crafted with an obsession for quality at each step of the production process. Serious collectors, sommeliers and merchants know how important it is to preserve that quality during long-term cellaring.

They also know that Vintec climate-controlled cellars are the most reliable tools for ensuring their collections are protected.

Created to meet standards of excellence born from a love of wine, they recreate the ideal storage conditions found only in the best natural underground cellars.

Whether you have dusty cases under your stairs or an investment-grade collection, Vintec has the range of capacities and styles to ensure your wine can be enjoyed at its best for many years to come.



# Contents

## Introduction

Why choose Vintec?	6
The Vintec story	8
The golden rules of wine storage	10
Features	12
Selecting your wine cellar	14

## Underbench Wine Cellars

Single Zone	18
Dual Zone	20

## Beverage Centres

Single Zone	24
-------------	----

## Tall Wine Cellars

Premium Multi Temp	28
Multi Temp	30
Single Zone	31

## Walk-in Cellars

Espace	34
Cavivision	37

## The Vintec Club

About the club	40
Private tastings	42
Accessories shop	44

## OENO

Virtual cellar manager	45
------------------------	----

## Technical Guidelines

Ventilation	52
Capacity	54
Temperature	56
Detailed specifications	58

## Warranty

65
----

Photo: 2x V190SG2E-BK installed at Feathers Hotel, Adelaide

# Why choose Vintec?

## Wine cellars are our specialty

In fact, that is all we do. Being intimately connected to the wine industry and focussed solely on wine cabinets for over two decades, we have developed the largest and most advanced range to suit all wine storage requirements.

## We care about your collection

Our highest priority is to offer the best and safest storage solution for your wine. For instance, all our cellars have dark interiors and dim UV-free lighting, instead of white interiors and bright lights. Why? Because it's important to keep your wine in a dark storage area.

## The Vintec guarantee

All Vintec wine cellars have been tested to ensure they function in Australian and New Zealand climates. Covered by a two year warranty, our cellars bear unique identification numbers that allow their origin and authenticity to be traced. They are also backed by dedicated phone support teams in Sydney and Auckland, as well as a national network of service specialists.

## Become a member of the Vintec Club

The Vintec Club is a private club for owners of Vintec wine cellars, offering exclusive benefits around wine. It's also a broader community for all wine lovers who enjoy learning and connecting with other like-minded wine lovers. Joining the club as a 'Guest' is free. To become a 'Member', you need to own and register a Vintec wine cellar.

Find out more on page 44.

Photo: 5x V190SG2E-BK installed at Rockpool, Sydney

## The Vintec story

# VINTEC

Vintec is recognised across Australia and the Asia-Pacific region as the benchmark for wine preservation solutions.

We offer precision tools for cellaring and serving that are coveted by enthusiastic collectors, sophisticated entertainers and industry professionals alike.

We are deeply passionate about wine, and believe that correct temperature control can unlock a whole new level of enjoyment and satisfaction for your wine experience.

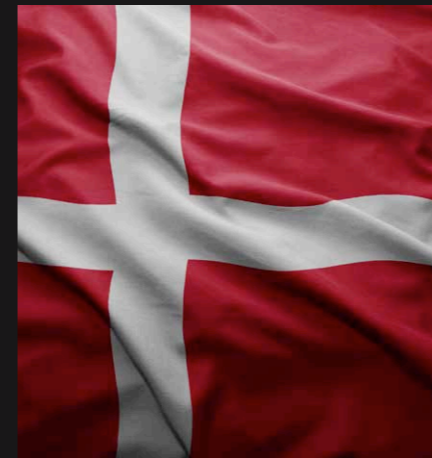

### Heritage

The Vintec brand was created in 2000 by two entrepreneurial French wine-lovers. They leveraged their previous experience with luxury wine cabinets to collaborate with Danish designers and manufacturers to introduce a range of stylish, functional and accessible wine preservation systems.



### Products

Born from a passion for wine, our products are designed to recreate the ideal storage conditions found in the best natural underground cellars – to meet the exacting standards of wine professionals and needs of discerning wine lovers.



### Knowledge

We offer wine expertise without the ego, to guide you along your wine journey and provide you with knowledge and confidence to appreciate your wine at its best.

# The Vintec 5 Pillars of Wine Storage

As wine lovers, we know first-hand how important your wine collection is to you. This is why we have spent over 20 years building our range on five core pillars of preservation.

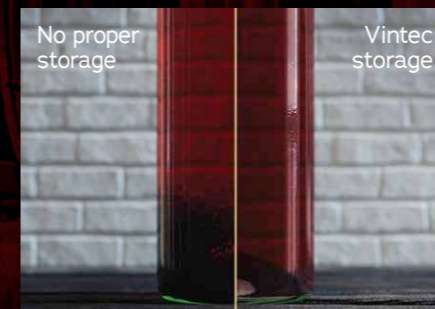

## Pillar 1:

### Stable temperature

Vintec wine cabinets are specially designed to maintain a constant temperature to preserve your wines, keeping them at their best and allowing them to mature steadily.

- Insulated side panels
- Double / triple-glazed doors

## Pillar 2:

### Humidity

Vintec wine cabinets are specially designed to maintain a higher humidity than a standard refrigerator to preserve corks and prevent your wine from oxidising while cellaring.

## Pillar 3:

### UV-proof dark storage area

Vintec wine cabinets are specially designed to prevent UV light from affecting your wine.

- UV-resistant tinted and insulated glass doors
- Dark interiors
- Double / triple-glazed doors
- UV-free LED lighting

## Pillar 4:

### Vibration-proof environment

Vintec wine cabinets are specially designed to keep all moving parts in suspension, absorbing and reducing to a minimum any vibrations, so that your wines are stored in a protected environment where they can mature steadily.

- Vibration-absorbing
- Sliding shelf rails
- Vibration-absorbing
- Oak and beech wooden shelves

## Pillar 5:

### Quality airflow

Vintec wine cabinets are equipped with an efficient air circulation system and selected models include an air filter to ensure a constant, slow flow of filtered air throughout the cabinet. This limits odours that can penetrate your wine and prevents mould from growing and damaging labels and corks.

# Features

## Why a wine cabinet instead of a fridge?

Traditional refrigerators generate intense cold and remove ambient humidity. They denature your wines and dry out corks.

Vintec wine cabinets are designed specifically for the preservation and maturation of your wines.

Our wine cabinets maintain a stable temperature to keep your wine in perfect cellaring conditions. This is thanks to triple glazed

glass, fully insulated cabinet panels and interactions between a compressor and thermostat. (Features may vary by model).

Selected models incorporate a winter heating function. In low ambient temperatures it gently warms the cabinet to ensure a constant year round temperature is maintained.

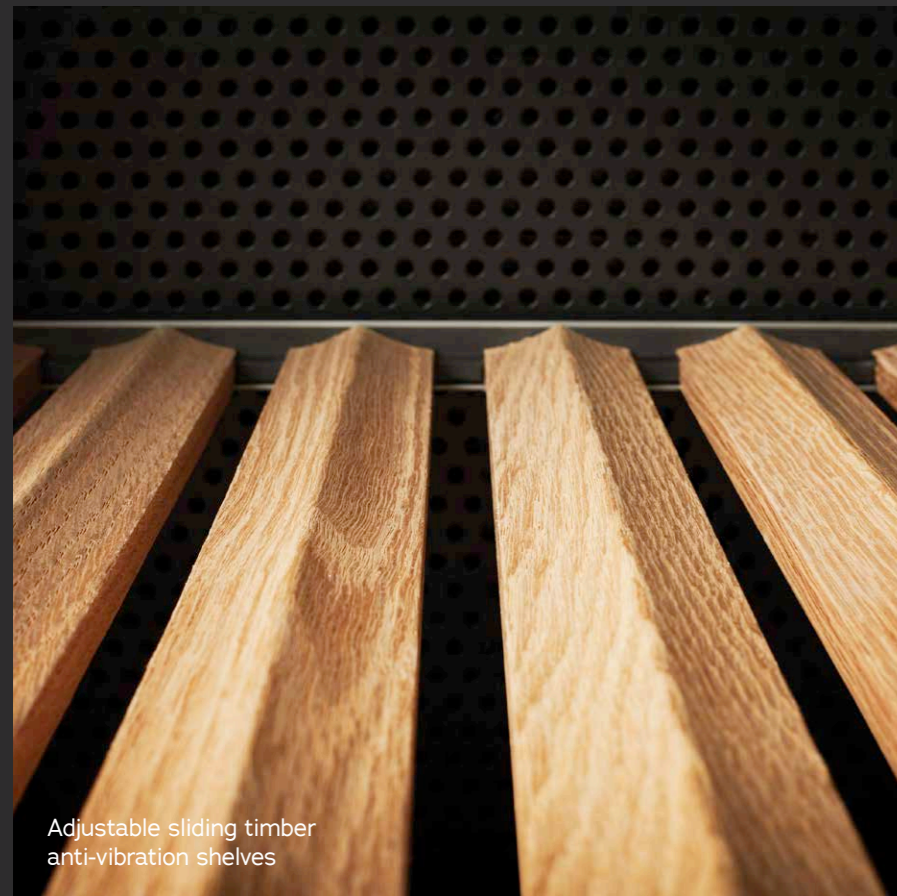

Adjustable sliding timber anti-vibration shelves

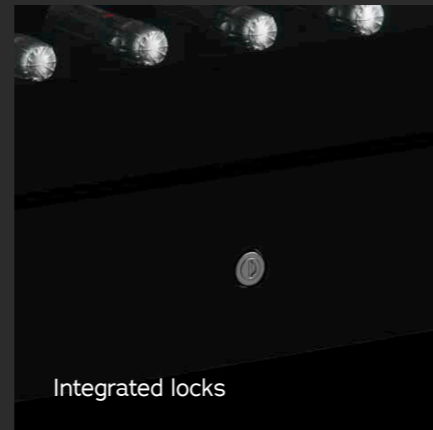

Integrated locks

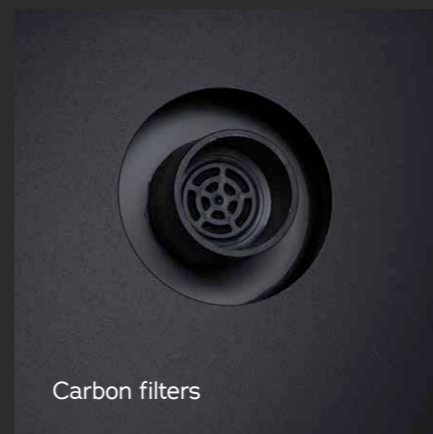

Carbon filters

## Caring for the environment as well as your wine

Vintec climate-controlled wine cabinets are equipped with energy-efficient R600a refrigerant gas, which has zero ozone-depleting properties.

The switch to R600a is part of a series of initiatives that Vintec has undertaken in order to limit our carbon footprint and to preserve the environment.



LED lighting, temperature display and control panels

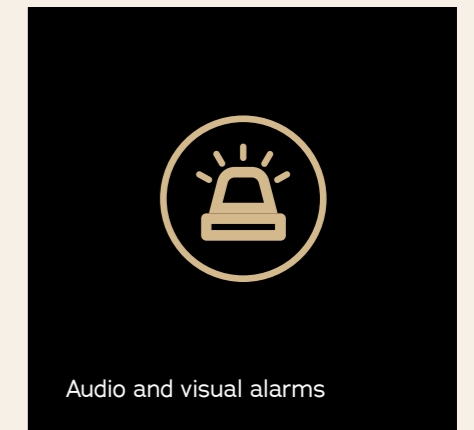

Audio and visual alarms

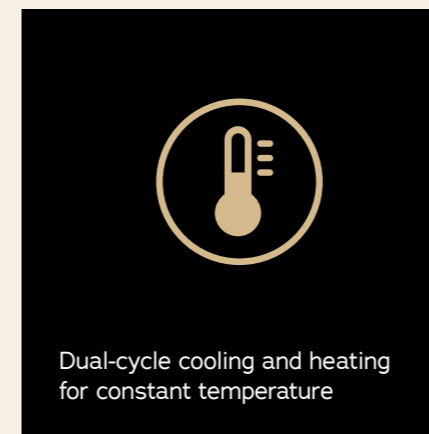

Dual-cycle cooling and heating for constant temperature

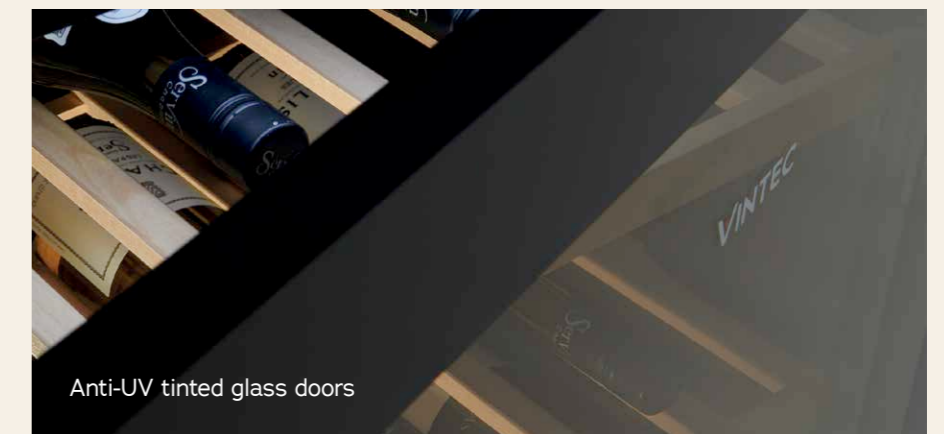

Anti-UV tinted glass doors

\*Features/images vary by model.

# Selecting your wine cellar

## Capacity



**Underbench Wine Cellars**  
20 - 50 bottles

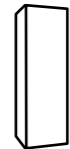

**Tall Wine Cellars**  
100 - 300 bottles

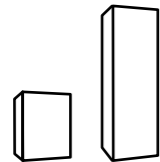

**Beverage Centres**  
40 - 250 beer bottles

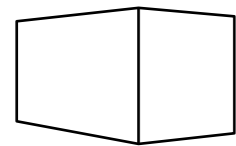

**Walk-in Cellars**  
600 - 4000 bottles



**Easy** = capacity that can be reached with all supplied shelves installed and with a maximum of 4 - 5 levels of stacking per shelf.  
**Max** = maximum capacity that can be reached. For some models, reaching this capacity requires using less shelves than supplied.

Capacities expressed are based on that achieved in our testing using standard 750ml Bordeaux style wine bottles (see page 54 for dimensions) or 330ml beer bottles. Our cellars can accommodate other shapes and sizes of bottles, however their inclusion will affect overall maximum capacity.

## Design

Vintec wine cellars are available in 2 stylish finishes to suit your décor.



Stainless Steel

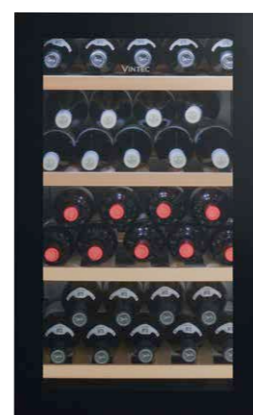

Borderless Black Glass

## Function



### Single Zone

Since all wines – reds, whites and Champagne – cellar at the same temperature (12° - 14°C), a Single Zone cellar is ideal for conveniently storing and cellaring all your wines. Alternatively, a Single Zone cellar can be used to serve wines at optimal drinking temperatures: either 6° - 8° for white, or 16° - 18° for red.



### Dual Zone

A Dual Zone cellar is ideal for keeping both reds and whites at optimal respective drinking temperatures. Set one compartment at 6° - 8°C for whites and Champagne, and the other at 16° - 18° for reds. Alternatively, one compartment can be set at a serving temperature and the other at 12° - 14° for cellaring.



### Multi Temp

Vintec's versatile Multi Temp technology is designed for serving different styles or varietals at their optimal individual drinking temperatures. For instance, setting the bottom at 6°C and the top at 18° generates a temperature gradient throughout the cellar allowing you to keep several different varietals all stored at their optimal drinking temperatures.





20 - 50

You love to entertain at home and it's important that your guests are well received. Vintec underbench wine cellars balance convenience with style, providing the same technical precision of their larger cousins in a more compact size. Have your best wines on hand at perfect serving temperatures ready to be enjoyed, or cellar a small collection with confidence.

## Underbench Wine Cellars



# Single Zone Wine Cellars

Wine cabinets for cellaring all varieties (set at 12° - 14°C).

## 50 Bottle capacity cellars

Underbench or freestanding



Max: 50  
Easy: 40

VWS050SBB



VWS050SSB



- Triple glazed door with anti-UV glass
- Adjustable wooden shelves
- Security lock
- Reversible door
- Digital temperature display
- LED internal lighting

- Triple glazed door with anti-UV glass
- Adjustable wooden shelves
- Security lock
- Reversible door
- Digital temperature display
- LED internal lighting

## 35 Bottle capacity cellars

Freestanding only



Max: 35  
Easy: 28

VWS035SBB

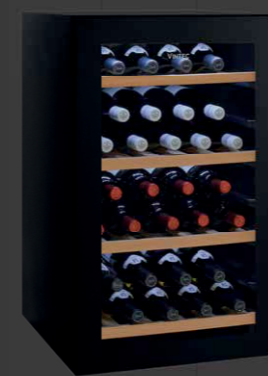

VWS035SSB



- FREESTANDING ONLY**
- Triple glazed door with anti-UV glass
- Adjustable wooden shelves
- Reversible door
- Digital temperature display
- LED internal lighting

- FREESTANDING ONLY**
- Triple glazed door with anti-UV glass
- Adjustable wooden shelves
- Reversible door
- Digital temperature display
- LED internal lighting

## 20 Bottle capacity cellar

Underbench / freestanding



Max: 20  
Easy: 18

VWS020SBB



- Triple glazed door with anti-UV glass
- Adjustable wooden shelves
- Security lock
- Reversible door
- Digital temperature display
- LED internal lighting



## Dual Zone Wine Cellars

A serving cabinet for white (set upper chamber at 6°C-8°C) and red (set lower chamber at 16°C-18°C). Temperature range of upper chamber is 6°C-12°C and lower chamber 12°C-18°C so both chambers can be set to 12 cellaring temperature.

### 50 Bottle capacity wine cellars

Underbench or freestanding











Max: 50  
Easy: 40









VWDO5OSBB



VWDO5OSSB



-  Triple glazed door with anti-UV glass
-  Two separate chambers
-  Adjustable wooden shelves
-  Security lock
-  Reversible door
-  Digital temperature display
-  LED internal lighting
-  Winter function (heating system)

-  Triple glazed door with anti-UV glass
-  Two separate chambers
-  Adjustable wooden shelves
-  Security lock
-  Reversible door
-  Digital temperature display
-  LED internal lighting
-  Winter function (heating system)



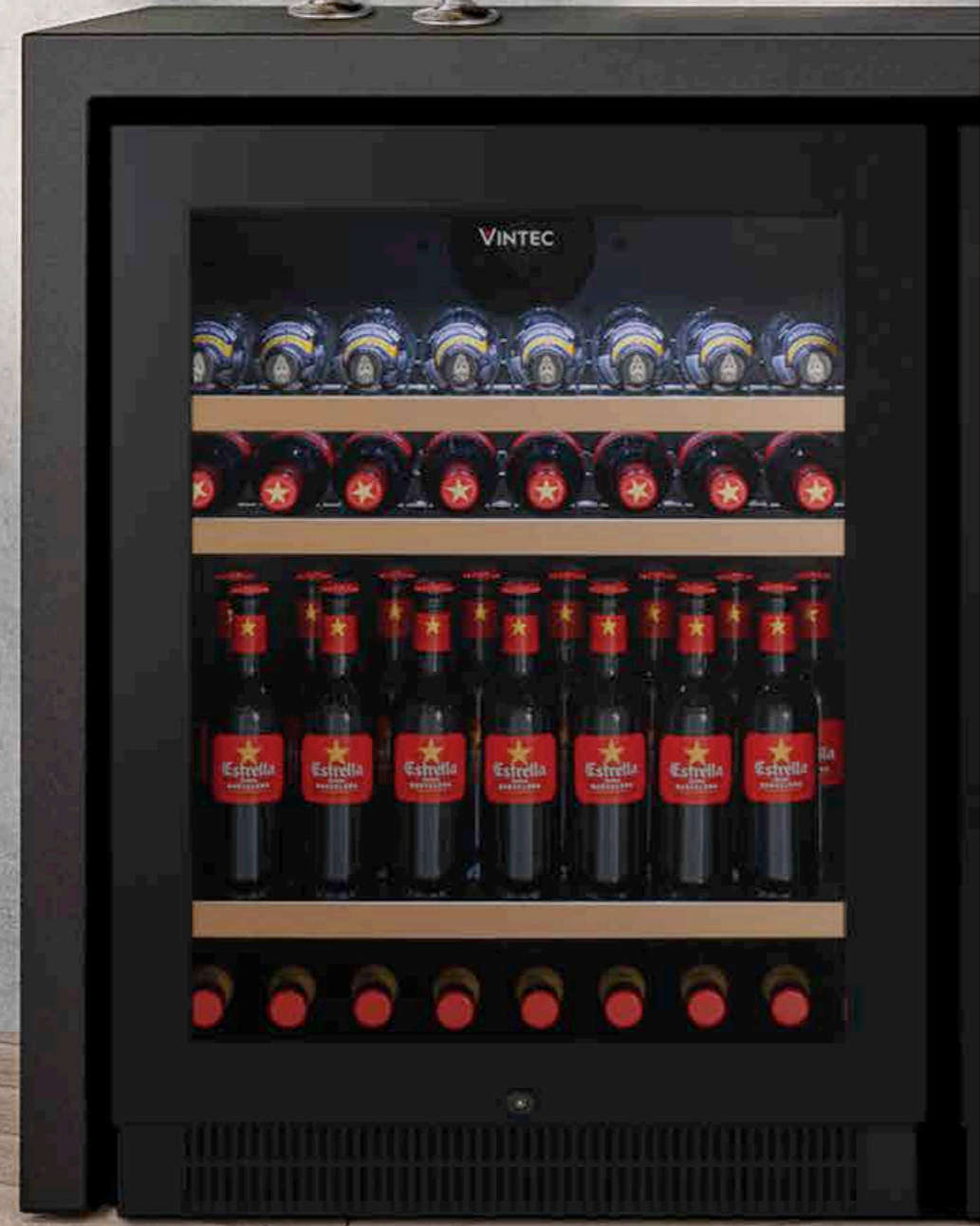

100 - 250

Our Beverage Centres offer the perfect solution for storing Champagne, white wine, beer and soft drinks, ready for serving.

# Beverage Centres

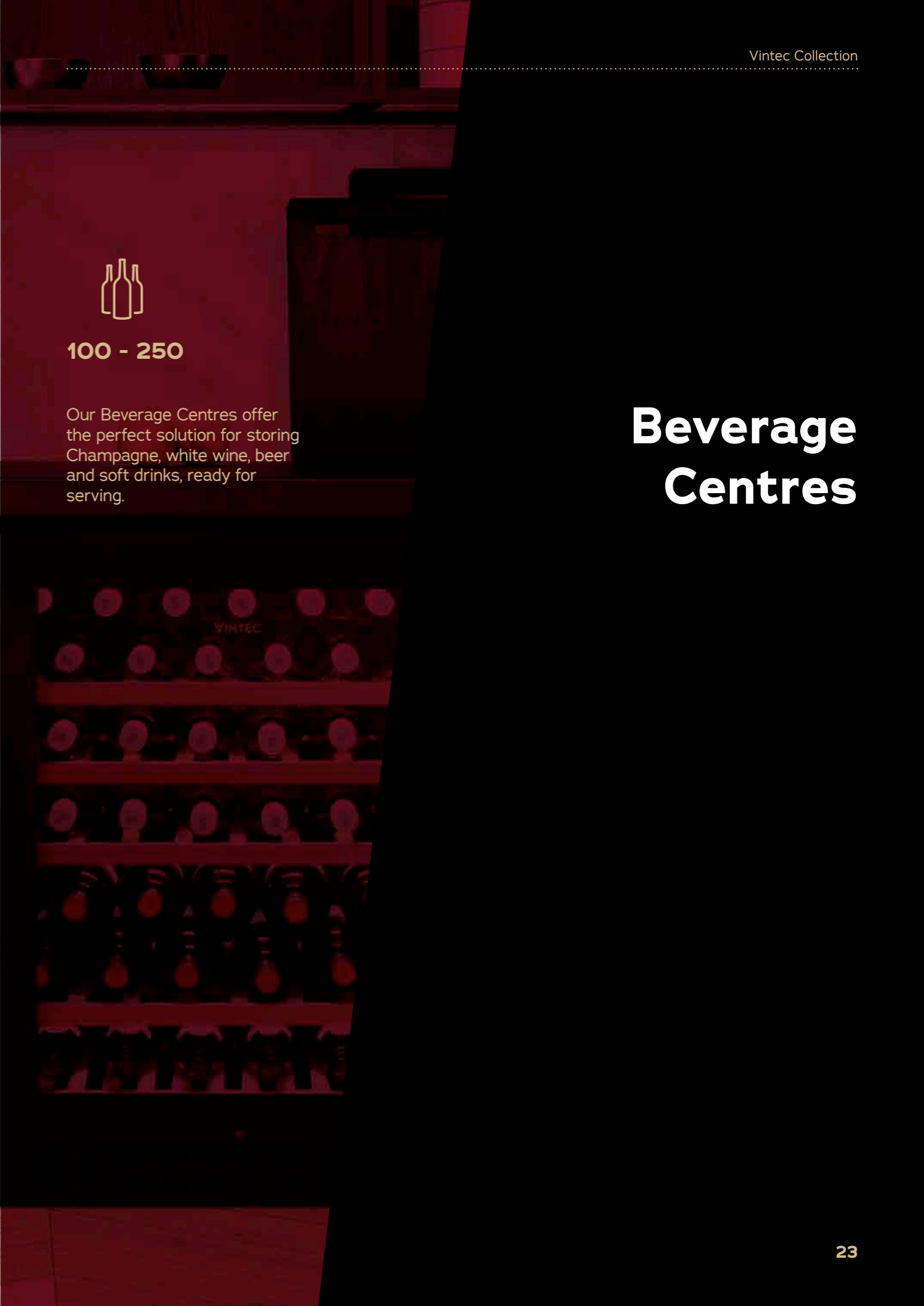



# Single Zone Beverage Centres

Perfect for entertaining, the Beverage Centre keeps beer cold at 2° - 5°C and chills white wines and Champagne for serving.

## 260 beer bottle capacity beverage centre

Slot-in or freestanding



Max: 260  
Easy: 200  
(330ml beer)

V190BVC-BK



- Double glazed door with anti-UV glass
- Adjustable shelves
- Security lock
- Digital temperature display
- LED internal lighting
- Audio and visual alarm

## 100 beer bottle capacity beverage centre

Underbench or freestanding



Max: 100  
Easy: 70  
(330ml beer)

VBS050SBB



- Triple glazed door with anti-UV glass
- Adjustable shelves
- Security lock
- Reversible door
- Digital temperature display
- LED internal lighting

VBS050SSB



- Triple glazed door with anti-UV glass
- Adjustable shelves
- Security lock
- Reversible door
- Digital temperature display
- LED internal lighting

## 40 beer bottle capacity beverage centre

Underbench or freestanding



Max: 48  
Easy: 35  
(330ml beer)

VBS020SBB



- Triple glazed door with anti-UV glass
- Adjustable shelves
- Security lock
- Reversible door
- Digital temperature display
- LED internal lighting



100 - 300

You collect and consume the finest wines; therefore you should have the best storage and serving solution available. From ageing to serving, a tall Vintec wine cellar is the answer to every wine connoisseur's dream.

## Tall Wine Cellars





# Premium Multi-Temp Wine Cellars

Multi Temp cellars can either be used with a consistent temperature of 12° - 14°C throughout for cellaring, or with a temperature gradient from top to bottom for serving different styles/ varietals at their optimal specific drinking temperature.

Premium models feature stylish matt glass finish, inverter compressor, touch controls and oak shelves with anodised metal trim to securely cradle your precious wine. Available in 2 sizes with configurations for maximum capacity and easy access to suit your individual needs.



Max: 180  
Easy: 150



Max: 306  
Easy: 210



Max: 126  
Easy: 110



Max: 198  
Easy: 130

VWM306PBA



- Double glazed door with anti-UV glass
- Fully extendable American Oak telescopic shelving
- Security lock
- Digital temperature display with touch controls
- Inverter compressor
- Premium strip LED lighting
- Audio and visual alarm
- Winter function (heating system)
- Sabbath mode

VWM306SBA



- Double glazed door with anti-UV glass
- Fixed American Oak shelving for optimum capacity
- Security lock
- Digital temperature display with touch controls
- Inverter compressor
- Premium strip LED lighting
- Audio and visual alarm
- Winter function (heating system)
- Sabbath mode

VWM198PBA



- Double glazed door with anti-UV glass
- Fully extendable telescopic American Oak shelving
- Security lock
- Digital temperature display with touch controls
- Inverter compressor
- Premium strip LED lighting
- Audio and visual alarm
- Winter function (heating system)
- Sabbath mode

VWM198SBA



- Double glazed door with anti-UV glass
- Fixed American Oak shelving for optimum capacity
- Security lock
- Digital temperature display with touch controls
- Inverter compressor
- Premium strip LED lighting
- Audio and visual alarm
- Winter function (heating system)
- Sabbath mode



## Multi-Temp Wine Cellars

Multi Temp cellars can either be used with a consistent temperature of 12° - 14°C throughout for cellaring, or with a temperature gradient from top to bottom for serving different styles/ varietals at their optimal specific drinking temperature.



Max: 198  
Easy: 130

V190SG2E-BK



- Double glazed door with anti-UV glass
- Solid Beechwood adjustable shelving
- Security lock
- Digital temperature display with touch controls
- LED internal lighting
- Audio and visual alarm
- Winter function (heating system)



Max: 148  
Easy: 100

VWM148SBA

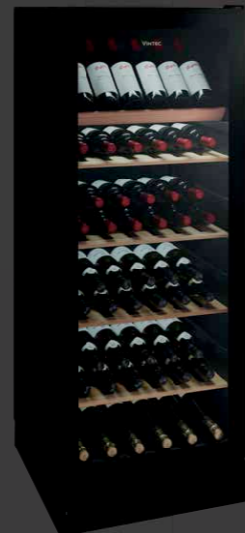

- Double glazed door with anti-UV glass
- Solid Beechwood adjustable shelving
- Security lock
- Digital temperature display with touch controls
- LED internal lighting
- Audio and visual alarm
- Winter function (heating system)



## Single Zone Wine Cellars

Wine cellars for cellaring all varieties (set at 12° - 14°C), or serving either white/Champagne (6° - 8°) or red (16° - 18°).



Max: 170  
Easy: 155

VWS17OSSB



- Triple glazed door with anti-UV glass
- Slide-out wooden shelves
- Security lock
- Reversible door
- Digital temperature display
- LED internal lighting
- Winter function (heating system)



Max: 130  
Easy: 110

VWS13OSSB



- Triple glazed door with anti-UV glass
- Slide-out wooden shelves
- Security lock
- Reversible door
- Digital temperature display
- LED internal lighting
- Winter function (heating system)





600 - 4000

The environmental simulation of an underground cave. Not only does it recreate the ideal storage conditions for large collections, but true connoisseurs will discover the unique feeling of physically walking into their own treasured cellar.

## Walk-in Cellars



# Espace





The Espace is the ultimate in luxurious convenience for the serious collector or industry professional. The unit can be built-in or freestanding, is delivered as a flat-pack and can be disassembled if you move to a new home or premises. Extension packs can be added if your collection grows, while sliding shelving and an impact-cushioning floor complete the package.



Max: 1000

## ESPACE1000-KIT



-  Double glazed door with anti-UV glass
-  Sliding and lockable shelving
-  Winter function (heating system)
-  Security lock
-  Digital temperature display

## Extension packs:

Increase your capacity in 500 bottle increments, up to a maximum of 4000 bottles. Packs include cabinet extension panels and additional shelving.



- ESPACE1500-KIT** Max: 1500
- ESPACE2000-KIT** Max: 2000
- ESPACE2500-KIT** Max: 2500
- ESPACE3000-KIT** Max: 3000
- ESPACE3500-KIT** Max: 3500
- ESPACE4000-KIT** Max: 4000





## Cavivision





Cavivision combines the elegance of a showcase to present your treasured collection with the luxury of a walk-in cellar. The unit can be built-in or freestanding, is delivered as a flat-pack and can be disassembled if you move to a new home or premises. Sturdy shelving and an impact-cushioning floor complete the package.



Max: 600

### CAVIVISION



-  Double glazed door with anti-UV glass
-  Security lock
-  Digital temperature display
-  Shelf-mounted LED display lights
-  24 fixed wooden shelves

# VINTEC CLUB

# VINTEC CLUB

The Vintec Club is a private club for owners of Vintec wine cellars. Purchasing any cellar entitles you to lifetime membership – our way of saying thank you to our discerning and valued customers who invariably love wine.

To find out more or become a member, go to [vintecclub.com](http://vintecclub.com)

 **Concierge**

Members of the Vintec Club have access to a dedicated Concierge service for cellar management tips, service requests, benefit enquiries and tastings bookings.

 **Private Tastings**

Members of the Vintec Club receive exclusive invitations to unique wine experiences and intimate dinners in the company of celebrated winemakers from around the world, in a family-like and relaxed atmosphere. These private events are subsidised to bring members exceptional experiences at nominal prices.

 **Club Expert**

Peter Bourne is synonymous with enthusiasm and passion for all things vinous. He's a wine educator and wine judge, who also writes for *Gourmet Traveller Wine* and *Qantas Magazine*. Members are encouraged to take advantage of his expertise via Q&A, as well as his regular feature columns at [vintecclub.com](http://vintecclub.com)

**Other member benefits from VC partners:**



Ongoing 20% VIP discount on Riedel glassware, decanters and accessories, with free nationwide shipping on purchases over \$100.



Lifetime membership, your own Personal Fine Wine Broker, a \$100 voucher\* to spend on fine wine and access to the Langton's Auction & Exchange platforms.



A complimentary dram of a unique SMWS whisky at our Vintec Club Private Tastings, plus a \$50 gift voucher on first purchase via SMWS's website.



\* min. spend required

# VINTEC CLUB

PRIVATE TASTINGS



# VINTEC CLUB

VC SHOP

The Vintec Club Shop is an exciting treasure trove of beautiful and functional accessories to enhance your wine appreciation. From serving and preserving to glassware and tableware, every item in our range is a collectible statement of style.

Vintec Club members receive generous discounts, as well as access to rare and limited edition items.

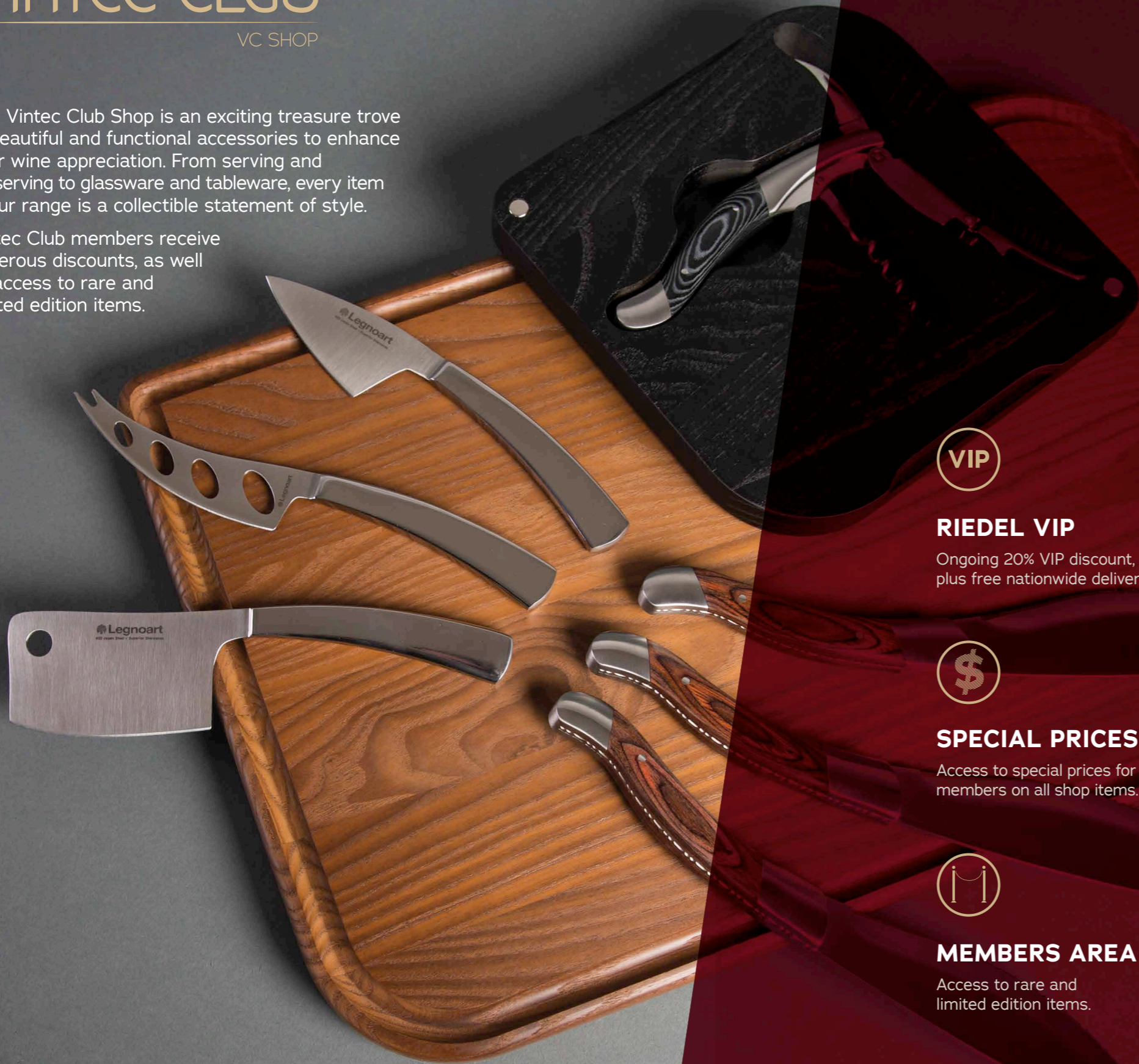

VIP

## RIEDEL VIP

Ongoing 20% VIP discount, plus free nationwide delivery.

\$

## SPECIAL PRICES

Access to special prices for club members on all shop items.

M

## MEMBERS AREA

Access to rare and limited edition items.

Browse today at [vintecclub.com/en-au/shop](http://vintecclub.com/en-au/shop)

## FEATURED BRANDS:



Professor Claus J. Riedel was the first to recognise that the bouquet and balance of wines are affected by the shape of the glass. Riedel is now recognised worldwide for designing and producing the highest quality glassware for the enjoyment of wine.



Legnoart was born out of love and passion for wood and beauty. After almost seventy years, Legnoart is among the major Italian companies in the household, kitchen and cellar furniture design business, and is distributed in over 52 countries.



## Ü110

Üllo is a revolutionary wine purifier that restores the natural taste of wine with Selective Sulfite Capture™ filter technology. Breathe life into reds, or maintain the balance of whites. Twist the aerator on or off to suit your preference.

# OENO

BY VINTEC





# OENO

BY VINTEC

OENO by Vintec is your virtual cellar management app and personal sommelier developed by Vintec and powered by Vivino. With OENO, wine lovers can effortlessly keep track of which wines they have, where they are located in their cellar(s) and know how to enjoy them at their best – with expert recommendations on when to open bottles, serving temperatures, decanting and glassware.

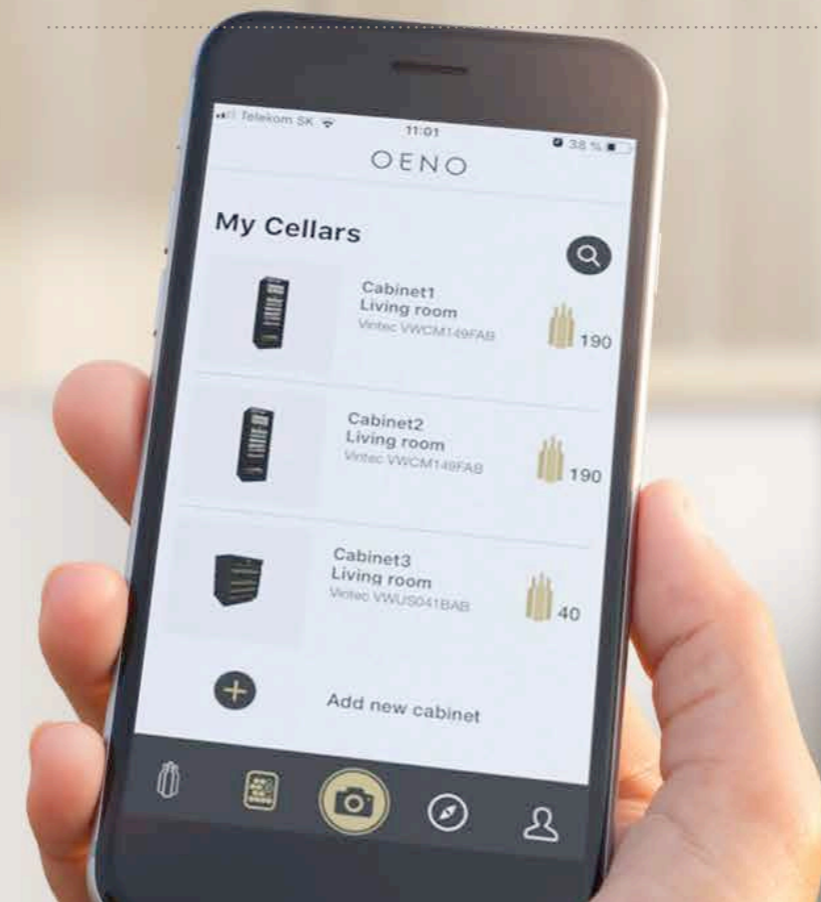

### OENO and The Vintec Club

Vintec Club members can register to OENO by using the same email address as in their Vintec Club profile to get access to premium features, including unlimited wine label scans and automatic import of cellar(s) details and configurations.

As OENO by Vintec evolves, more features will become available. Read all about the Vintec Club below.

## 1. Configure

Create a virtual replica of your wine cellar(s) with great precision. Vintec Cellar owners can automatically import the model and configuration of their registered cellars on the Vintec Club website to OENO.

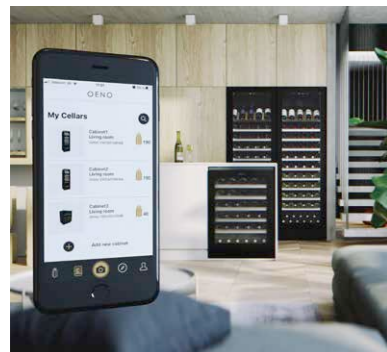

## 2. Scan & Explore

Snap a photo of a wine bottle label to automatically identify and retrieve all information about the wine – including grape varieties, vintage, ratings and more – powered by Vivino.

Get recommendations for more than 300 different wine regional styles and varieties, to help you enjoy your wines at their best – serving temperatures, aging potential, aeration and glassware to use.

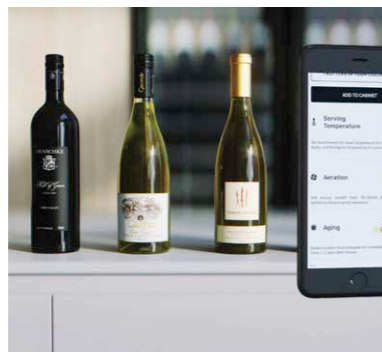

## 3. Store

Keep track of which wines they have and where they are located exactly in your cellar(s). Manage your collection by adding multiple bottles at once, move them around and drink them as you wish.

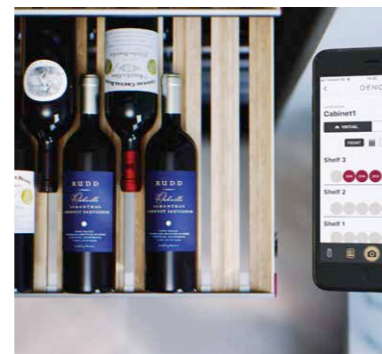

## 4. Taste

Get recommendations on pairings and what to drink from your cellar.

The “What to drink?” tool provides recommendations on which wines from your collection you should drink based on food pairings, grape varieties, countries or wine ratings. It helps you browse through your collections and quickly find the best bottle to open for occasion.



## 5. Order & Restock

Order, restock and build your wine collection through our unique integration with Vivino Market – users will be directed to Vivino Market whenever they wish to buy or restock (coming soon).



## Available for all Wine Lovers

OENO by Vintec is a free app. It is available for download from the App Store (iOS) and Google Play (Android).

The app has been released in Australia, New Zealand, Singapore and the United States. Soon we will be releasing it in new countries – stay tuned!



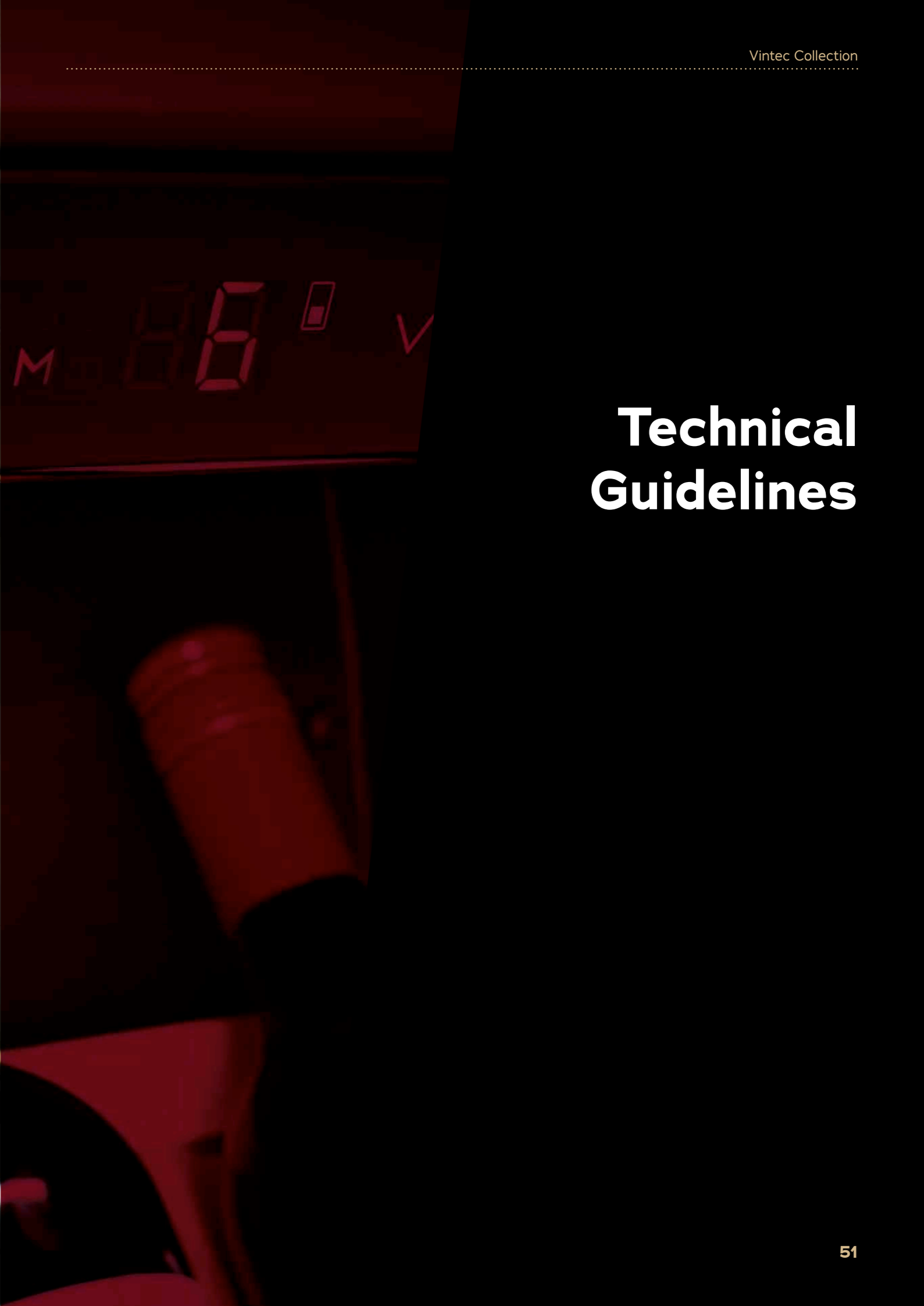

# Technical Guidelines

# Ventilation

All Vintec cellars are equipped with compressors that generate heat and therefore require a minimum ventilation gap when building them into cabinetry, or positioning them under benches or adjacent to other appliances. The diagrams on these pages are a guide to assist purchasing selection, but detailed, model-specific ventilation requirements

should be obtained from our website at [vintec.com](http://vintec.com) prior to installation. A ventilation grill must be installed for any cabinet built under bench or into cabinetry.

## Outdoor/alfresco use

Units being installed in outdoor/alfresco areas must be kept out of direct sunlight and away from rain.

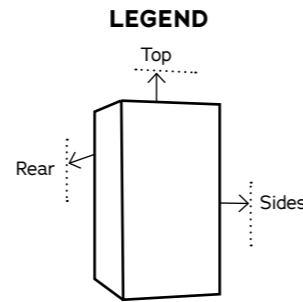

**Illustrations not to scale.**  
All dimensions in millimetres.

**VWM148/198/306 models**

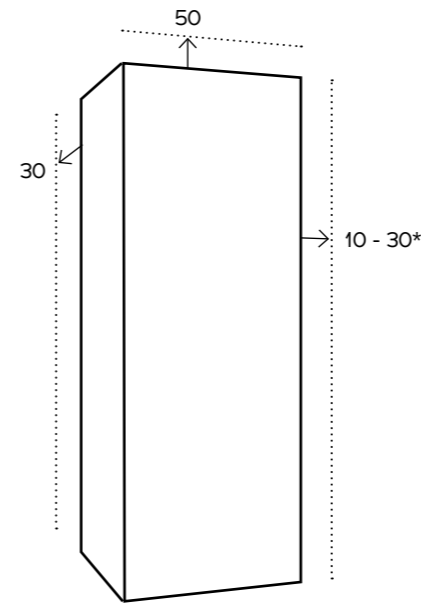

**V190 models**

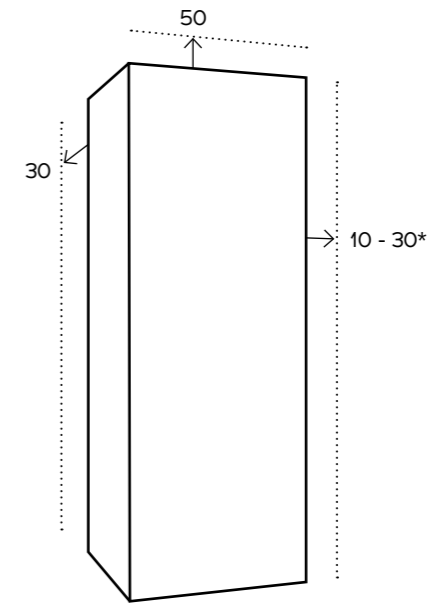

**VWS130/170 models**

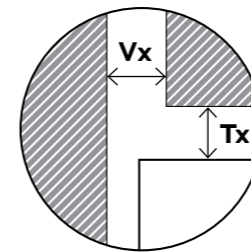
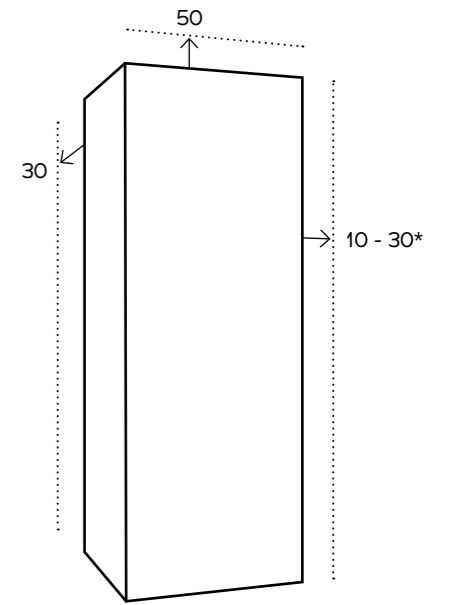

Note: If a vertical vent space (Vx) of 100mm is provided, then a minimum top ventilation gap (Tx) of 50mm is sufficient, but otherwise minimum Tx of 100mm is required.

\* Extra space is recommended on the opening edge/top for easy finger grip access, as well as on the hinge side to allow doors to open wide enough for shelves to slide out.

**VBS/VWS020 models**

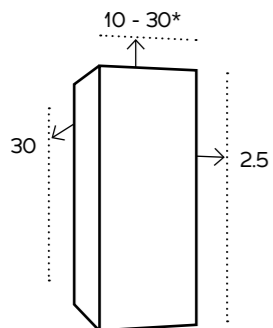

**VWS035 models**

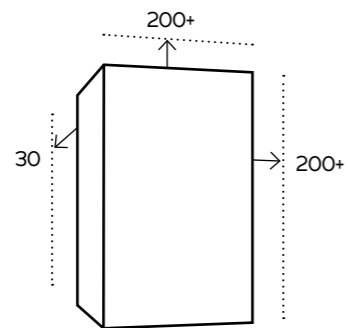

**VBS/VWD/VWS050 models**

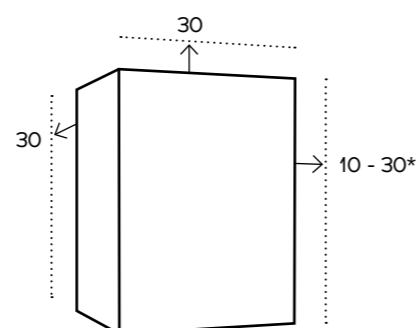

\* Extra space is recommended on the opening edge/top for easy finger grip access, as well as on the hinge side to allow doors to open wide enough for shelves to slide out.

## Underbench installation

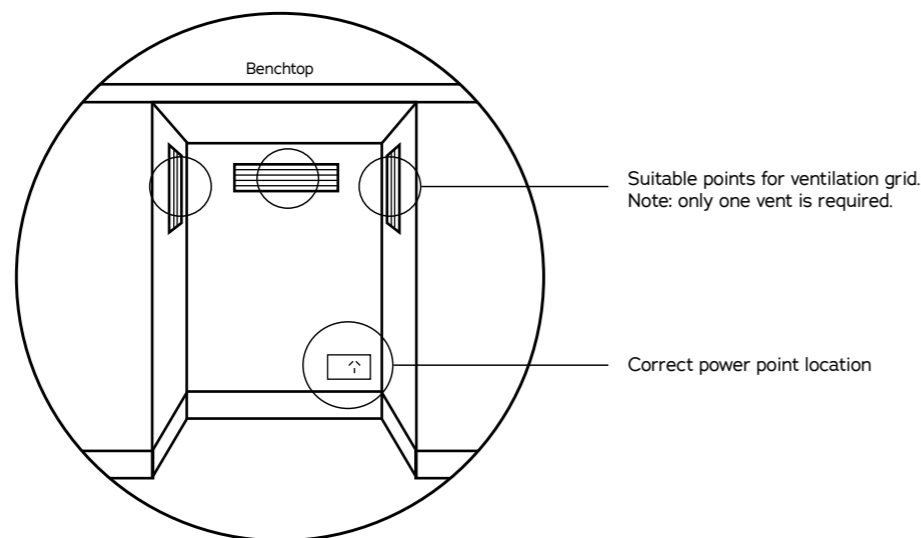

## Walk-in Cellar models

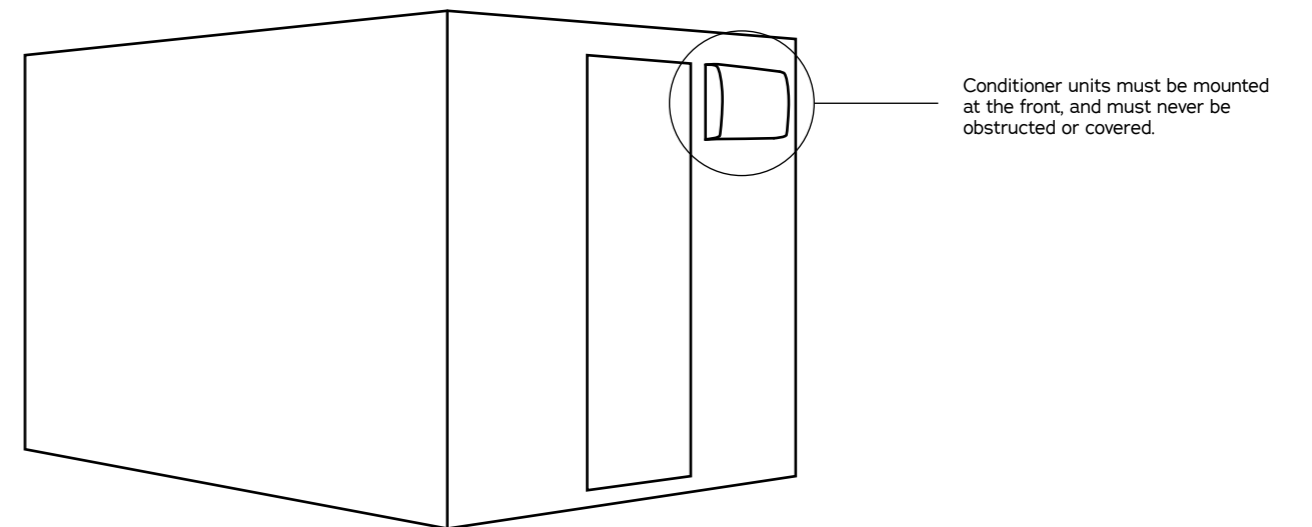

# Capacity and shelf stacking

## Different shapes and sizes

This brochure makes reference to the 'standard Bordeaux style bottle' when specifying capacity. The dimensions and proportions of this bottle shape are shown at 1. However, wine producers use a huge range of different bottle shapes and sizes, some of which are shown at 2.

Bottle shape variety should be considered when selecting the appropriate Vintec cabinet in which to house your precious collection, since shelf height and adjustability varies across the product range.

Please also be aware that some bottles will not fit opposite each other on the same shelf and this may affect capacity. You may need to lay the bottles opposite more suitably shaped bottles.

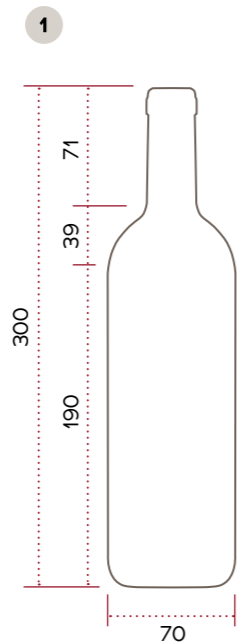

Standard Bordeaux style bottle dimensions



Standard Bordeaux style

Maximum capacity is based on our testing using standard 750ml Bordeaux style wine bottles. Our cellars can accommodate other shapes and sizes of bottles however this will result in a reduction in maximum capacity.

**NOTE: Illustrations not to scale.**  
All dimensions in millimetres.

## Stacking for ageing

When filling your cabinet, we suggest stacking the bottles you wish to cellar and mature at the back of the shelves, and the wines you wish to consume in the short-term at the front (see below).

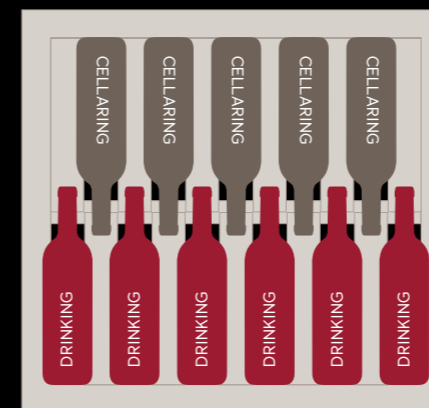

Shelf top view

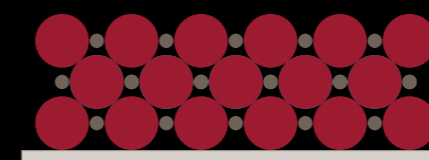

Shelf front view

**NOTE: Images are illustrative only and will vary with bottle style and model.**

## Stacking for accessibility

When stacking bottles, it is practical to keep bottles from the same case together. See diagrams below, in which bottles from the same case are represented by the same colours.

Vertically stacking same-case bottles enables safe and easy access to all your different wines.

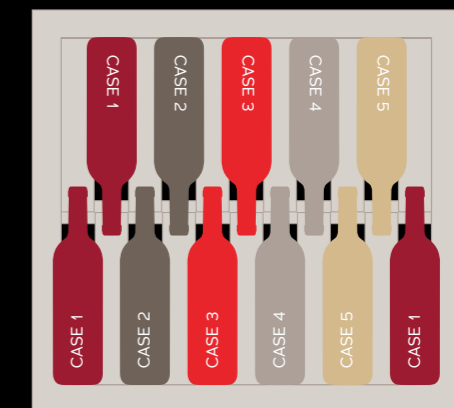

Shelf top view

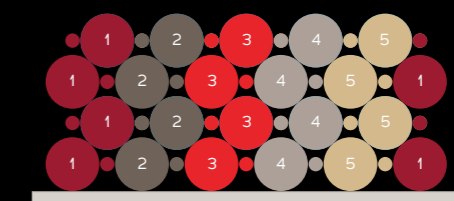

Shelf front view

# Cellaring and serving temperatures

Although all wines – reds, whites and Champagnes – should be cellared at the same temperature, different wines have different ideal serving temperatures. Cellar and serve your wines according to the chart below in order to always enjoy your wines at their best.



## Cellaring

Fridge temperature  
(too cold)

Optimal cellaring temperature  
for all wines  
(red, white and Champagne)

Ambient Australian room temperature  
(too hot)



## Serving



**IF SERVED BELOW IDEAL TEMPERATURE:**

Tannins will be harsher; bitterness and acidity will be accentuated.

Sauvignon Blanc & Champagne

Chardonnay

Pinot Noir & Merlot

Cabernet Sauvignon & Shiraz

**IF SERVED ABOVE IDEAL TEMPERATURE:**

Aromas are stripped of their finesse and hidden by a sensation of alcohol.

## VINTEC CLUB

For more expert advice and great resources on collecting, cellaring and serving wine, visit [vintecclub.com](http://vintecclub.com)

# Detailed specifications

## Underbench Wine Cellars

	VWSO20SBB	VWSO35SBB	VWSO35SSB	VWSO50SSB	VWSO50SBB	VWDO50SSB	VWDO50SBB
<b>Bottle capacity*</b>	20	35	35	50	50	50	50
<b>Primary function</b>	Cellar red & white	Cellar red & white	Cellar red & white	Cellar red & white	Cellar red & white	Zone 1: Serve red Zone 2: Serve white	Zone 1: Serve red Zone 2: Serve white
<b>Alternate function</b>	Serve red or white	Serve red or white	Serve red or white	Serve red or white	Serve red or white	Zone 1: Serve Zone 2: Cellar	Zone 1: Serve Zone 2: Cellar
<b>Finish</b>	Black glass	Black glass	Stainless steel	Stainless steel	Black glass	Stainless steel	Black glass
<b>Temperature zones</b>	1	1	1	1	1 °C	2	2
<b>Temperature ranges (°C)</b>	6°C to 18°C	6°C to 18°C	6°C to 18°C	6°C to 18°C	6°C to 18°C	Zone 1: 6°C-12°C Zone 2: 12°C-18°C	Zone 1: 6°C-12°C Zone 2: 12°C-18°C
<b>Shelves</b>	5 full, 1 half	3 full, 1 half	3 full, 1 half	4 full, 1 half	4 full, 1 drawer	3 full, 1 half	3 full, 1 half
<b>Shelving material</b>	Beech	Beech	Beech	Beech, SS front	Beech	Beech, SS front	Beech
<b>Mood lighting</b>	Crystal white LED	Crystal white LED	Crystal white LED	Crystal white LED	Crystal white LED	Crystal white LED	Crystal white LED
<b>Door type</b>	Glass	Glass	Glass	Glass	Glass	Glass	Glass
<b>Built-in or freestanding only</b>	Both	Freestanding only	Freestanding only	Both	Both	Both	Both
<b>Stabilised temperature control</b>	✓	✓	✓	✓	✓	✓	✓
<b>Dark storage area<sup>2</sup></b>	✓	✓	✓	✓	✓	✓	✓
<b>Vibration reduction system</b>	✓	✓	✓	✓	✓	✓	✓
<b>Frequent air circulation</b>	✓	✓	✓	✓	✓	✓	✓
<b>Lock</b>	✓	✓	✓	✓	✓	✓	✓
<b>Winter heating function</b>						✓	✓
<b>LED display panel</b>	✓	✓	✓	✓	✓	✓	✓
<b>Alarm (audible and visual)</b>				✓	✓	✓	✓
<b>Alarm (visual only)</b>				✓	✓	✓	✓
<b>Energy efficient R600a gas</b>	✓	✓	✓	✓	✓	✓	✓
<b>Reversible door</b>	✓	✓	✓	✓	✓	✓	✓
<b>Dimensions (H x W x D) (mm)</b>	820 x 295 x 575	830 x 493 x 577	830 x 493 x 588	820 x 595 x 563	820 x 595 x 563	820 x 595 x 563	820 x 595 x 563
<b>Rear spacer<sup>3</sup> (mm)</b>	30	30	30	30	30	30	30
<b>Front or rear venting</b>	Front	NA	NA	Front	Front	Front	Front
<b>Body colour</b>	Black	Black	Black	Black	Black	Black	Black
<b>Door supplied right or left hinged</b>	RH	RH	RH	RH	RH	RH	RH
<b>Weight (kg)</b>	28	39	40	47	52	48	52
<b>Electricity consumption<sup>4</sup> (kWh/day)</b>	1	1	1	1	1	1	1
<b>Rated voltage (V)</b>	220-240	220-240	220-240	220-240	220 - 240	220-240	220 - 240
<b>Glazing and UV-treatment</b>	Triple glazed, UV	Triple glazed, UV	Triple glazed, UV	Triple glazed, UV	Triple glazed, UV	Triple glazed, UV	Triple glazed, UV

**Note:** While product specifications are accurate at the time of printing, changes and improvements can occur at any time  
 \* Max capacity, based on that achieved in our testing using standard 750ml Bordeaux style wine bottles or 330ml beer bottles  
 1 When set at 12 - 14° celsius  
 2 Dark interiors and tinted glass  
 3 Refer to install specs available at vintec.com  
 4 Actual energy consumption will depend on the ambient temperature, the set temperature and how often the door is opened

## Tall Wine Cellars

	VWS130SSB	VWS170SSB	V190SG2E-BK	VWM148SBA	VWM198SBA	VWM198PBA	VWM306SBA	VWM306PBA
<b>Bottle capacity*</b>	130	170	198	148	198	126	306	180
<b>Primary function</b>	Cellar red & white	Cellar red & white	Serve all	Serve all	Serve all	Serve all	Serve all	Serve all
<b>Alternate function</b>	Serve red or white	Serve red or white	Cellar red & white	Cellar red & white	Cellar red & white	Cellar red & white	Cellar red & white	Cellar red & white
<b>Finish</b>	Stainless steel	Stainless steel	Black glass	Black glass	Black glass	Black glass	Black glass	Black glass
<b>Temperature zones</b>	1	1	1 or multi	1 or multi	1 or multi	1 or multi	1 or multi	1 or multi
<b>Temperature ranges (°C)</b>	6 to 18	6 to 18	6 to 22	6 to 22	5 to 20	5 to 20	5 to 20	5 to 20
<b>Shelves</b>	10 sliding, 1 half	14 sliding, 1 half	4 Full adjustable, 1 display, 1 ¾ shelf	3 Full adjustable, 1 display, 1 ¾ shelf	4 Full adjustable, 1 display shelf, 1 ¾ shelf	7 Full on telescopic slides, 1 full fixed, 1 display shelf, 1 ¾ shelf	6 Full adjustable	11 Full on telescopic slides, 1 full fixed
<b>Shelving material</b>	Beechwood, SS front	Beechwood, SS front	American Oak	American Oak	American Oak, Alum front	American Oak, Alum front	American Oak, Alum front	American Oak, Alum front
<b>Mood lighting</b>	Blue LED	Blue LED	Crystal white LED	Crystal white LED	Crystal white LED	Crystal white LED	Crystal white LED	Crystal white LED
<b>Door type</b>	Glass	Glass	Glass	Glass	Glass	Glass	Glass	Glass
<b>Built-in or freestanding only</b>	Both	Both	Both	Both	Both	Both	Both	Both
<b>Stabilised temperature control</b>	✓	✓	✓	✓	✓	✓	✓	✓
<b>Dark storage area<sup>2</sup></b>	✓	✓	✓	✓	✓	✓	✓	✓
<b>Vibration reduction system</b>	✓	✓	✓	✓	✓	✓	✓	✓
<b>Frequent air circulation</b>	✓	✓	✓	✓	✓	✓	✓	✓
<b>Lock</b>	✓	✓	✓	✓	✓	✓	✓	✓
<b>Winter heating function</b>	✓	✓	✓	✓	✓	✓	✓	✓
<b>LED display panel</b>	✓	✓	✓	✓	✓	✓	✓	✓
<b>Alarm (audible and visual)</b>			✓	✓	✓	✓	✓	✓
<b>Alarm (visual only)</b>	✓	✓						
<b>Inverter compressor</b>					✓	✓	✓	✓
<b>Energy efficient R600a gas</b>	✓	✓	✓	✓	✓	✓	✓	✓
<b>Reversible door</b>	✓	✓						
<b>Display Shelf included</b>			✓		✓	✓	✓	✓
<b>Display shelves available for order</b>			✓	✓	✓	✓	✓	✓
<b>Dimensions (H x W x D) (mm)</b>	1400 x 595 x 680	1770 x 595 x 680	1860 x 595 x 610	1550 x 595 x 610	1850 x 595 x 610	1850 x 595 x 610	1940 x 705 x 700	1940 x 705 x 700
<b>Rear spacer<sup>3</sup> (mm)</b>	30	30	30	30	30	30	30	30
<b>Front or rear venting</b>	Front	Front	Rear	Rear	Rear	Rear	Rear	Rear
<b>Body colour</b>	Black	Black	Black	Black	Black	Black	Black	Black
<b>Door supplied right or left hinged</b>	RH	RH	Specify	Specify	Specify	Specify	Specify	Specify
<b>Weight (kg)</b>	86	105	84	84	85	85	110	110
<b>Electricity consumption<sup>4</sup> (kWh/day)</b>	1	1	1	1	1	1	1	1
<b>Rated voltage (V)</b>	220 - 240	220 - 240	220 - 240	220 - 240	220 - 240	220 - 240	220 - 240	220 - 240
<b>Glazing and UV-treatment</b>	Triple glazed, UV	Triple glazed, UV	Double glazed, UV	Double glazed, UV	Double glazed, UV	Double glazed, UV	Double glazed, UV	Double glazed, UV

**Note:** While product specifications are accurate at the time of publication, changes and improvements can occur at any time  
 \* Max capacity, based on that achieved in our testing using standard 750ml Bordeaux style wine bottles or 330ml beer bottles  
 1 When set at 12 - 14° celsius  
 2 Dark interiors and tinted glass  
 3 Refer to install specifications available at vintec.com  
 4 Actual energy consumption will depend on the ambient temperature, the set temperature and how often the door is opened

## Beverage Centres

	VBSO2OSBB	VBSO5OSSB	V19OBVC-BK	VBSO5OSBB
<b>Bottle capacity*</b>	48 (beer)	100 (beer)	260 (beer)	100 (beer)
<b>Primary function</b>	Serve beer & white	Serve beer & white	Serve beer & white	Serve beer & white
<b>Alternate function</b>	NA	NA	NA	NA
<b>Finish</b>	Black glass	Stainless steel	Black glass	Black glass
<b>Temperature zones</b>	1	1	1	1
<b>Temperature ranges (°C)</b>	2 to 10	2 to 10	2 to 10	2 to 10
<b>Shelves</b>	3 full	3 adjustable	6 adjustable	3 adjustable
<b>Shelving material</b>	Metallic, wood front	Metallic, SS front	Metallic	Metallic wood front
<b>Mood lighting</b>	Crystal white LED	Crystal white LED	Crystal white LED	Crystal white LED
<b>Door type</b>	Glass	Glass	Glass	Glass
<b>Built-in or freestanding only</b>	Both	Both	Both	Both
<b>Stabilised temperature control</b>	✓	✓	✓	✓
<b>Dark storage area<sup>2</sup></b>	✓	✓	✓	✓
<b>Vibration reduction system</b>	✓	✓	✓	✓
<b>Frequent air circulation</b>	✓	✓	✓	✓
<b>Lock</b>	✓	✓	✓	✓
<b>LED display panel</b>	✓	✓	✓	✓
<b>Alarm (audible and visual)</b>			✓	
<b>Alarm (visual only)</b>				
<b>Energy efficient R600a gas</b>	✓	✓	✓	✓
<b>Reversible door</b>	✓	✓		✓
<b>Dimensions (H x W x D) (mm)</b>	820 x 295 x 575	820 x 595 x 563	1860 x 595 x 610	820 x 595 x 563
<b>Rear spacer<sup>3</sup> (mm)</b>	30	30	30	30
<b>Front or rear venting</b>	Front	Front	Rear	Front
<b>Body colour</b>	Black	Black	Black	Black
<b>Door supplied right or left hinged</b>	RH	RH	Specify	RH
<b>Weight (kg)</b>	28	47	84	52
<b>Electricity consumption<sup>4</sup> (kWh/day)</b>	1	1	1	1
<b>Rated voltage (V)</b>	220-240	220-240	220 - 240	220 - 240
<b>Glazing and UV-treatment</b>	Triple glazed, UV	Triple glazed, UV	Double glazed, UV	Triple glazed, UV

**Note:** While product specifications are accurate at the time of printing, changes and improvements can occur at any time

\* Max capacity, based on that achieved in our testing using standard 750ml Bordeaux style wine bottles or 330ml beer bottles

1 When set at 12 - 14° celsius

2 Dark interiors and tinted glass

3 Refer to install specs available at vintec.com

4 Actual energy consumption will depend on the ambient temperature, the set temperature and how often the door is opened

## Walk-in Cellars

	CAVISIONION	ESPACE
<b>Bottle capacity*</b>	600	1000
<b>Primary function</b>	Cellar red & white	Cellar red & white
<b>Alternate function</b>	NA	NA
<b>Finish</b>	Classic black	Classic black
<b>Temperature zones</b>	1	1
<b>Temperature ranges (°C)</b>	8 to 18	8 to 18
<b>Shelves</b>	24 fixed	23 sliding
<b>Shelving material</b>	Wood	Wood
<b>Mood lighting</b>	Shelf-mounted LED display strips	Internal light
<b>Door type</b>	Glass	Glass
<b>Built-in or freestanding only</b>	Both	Both
<b>Stabilised temperature control</b>	✓	✓
<b>Dark storage area<sup>1</sup></b>	✓	✓
<b>Vibration reduction system</b>	✓	✓
<b>Frequent air circulation</b>	✓	✓
<b>Lock</b>	✓	✓
<b>Winter heating function</b>		✓
<b>LED display panel</b>	✓	✓
<b>Dimensions (H x W x D) (mm)</b>	2050 x 1270 x 1170	2050 x 1870 x 1170
<b>Front or rear venting</b>	Front	Front
<b>Body colour</b>	Black	Black
<b>Door supplied right or left hinged</b>	RH	RH
<b>Weight (kg)</b>	310	310
<b>Electricity consumption<sup>2</sup> (kWh/day)</b>	2	3.5 - 4
<b>Rated voltage (V)</b>	220 - 240	220 - 240
<b>Glazing and UV-treatment</b>	Double glazed, UV	Double glazed, UV

**Note:** While product specifications are accurate at the time of printing, changes and improvements can occur at any time

\* Max capacity, based on that achieved in our testing using standard 750ml Bordeaux style wine bottles or 330ml beer bottles

1 Dark interiors and tinted glass

2 Actual energy consumption will depend on the ambient temperature, the set temperature and how often the door is opened





### Warranty

Electrolux Home Products Pty Ltd and Electrolux (NZ) Limited (collectively Electrolux) warrants that for domestic applications the appliances featured in this brochure are free from defects in materials and workmanship for 2 years and warrants that for featured accessories a period of 12 months, following the date of original purchase and subject to the conditions set out in the warranty card accompanying the product when purchased. This warranty is in addition to the other rights and warranties you may have under the Australian Consumer Law (ACL) and Electrolux will at all times comply with its obligations at law including the ACL. For New Zealand customers Electrolux will at all times comply with its obligations pursuant to law including the Consumer Guarantees Act, the Sale of Goods Act and the Fair Trading Act. Where appliances are purchased in NZ for commercial purposes the Consumer Guarantees Act does not apply.

### Product information

The descriptors and illustrations in this publication apply to the specific products and models described as at the date of issue. Under our policy of continuous product development, product specifications may change without notice. Prospective purchasers should therefore check with their retailer to ensure this publication correctly describes the products that are being offered for sale.

All information supplied is to be used for general reference purposes only and is on the understanding that Electrolux will not be liable for any loss, liability or damage of whatever kind arising as a result of reliance on such information. Electrolux will at all times comply with its obligations pursuant to law. Colours of products illustrated are as close as printing limitations allow.

Photo: 3x V190BVC-BK installed at Cirrus Dining, Sydney.

# VINTEC

**Vintec.** We are part of the Electrolux Family. To add a touch of professional inspiration to your home, visit [electrolux.com.au](http://electrolux.com.au)

Electrolux Home  
Products Australia

1800 666 778

[vintec.com](http://vintec.com)

© 2020 Electrolux Home Products Pty Ltd.  
ABN 51 004 762 341  
V\_BRO\_VintecMaster\_Sep20

