

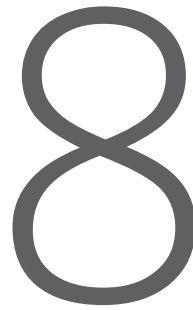

SUPALINE

Premium decorative wall and ceiling feature panel system

Graceful curve effects • 3D versions available • Easily conceal access points



reasons
designers
choose
SUPALINE

SUPALINE is ideal for applications such as:

- > Feature walls or ceiling
- > High traffic areas such as lobbies, receptions areas, atriums and passageways
- > High activity area such as multi-purpose halls and sports centres
- > Decorative panels for pillars or beams
- > Office partitions



Flexible

Concave, convex and S-curves are all possible.



Fast

A panel system for quick on-site installation.



Easy

Simple to specify with shop drawing service if required.



Attractive

Huge range of beautiful finishes.



Robust

Excellent durability and low maintenance.



Effects

Add grooved and routed effects for unique patterns.



Access

Ideal for concealing service access in ceilings and walls.



3D

Framing for 3D shapes also supported.



▲ SUPAVENEER panels form a faceted wall in a uni lecture theatre.



▲ SUPAVENEER Hoop Pine curved panels under the exterior eaves of a multipurpose school hall.

▼ SUPACOLOUR panels form a durable and attractive entry to a city building with extra wide joints and matching backing strips.



▼ SUPALINE grooved in 4 different spacings in durable SUPAFINISH Hoop Pine limed in a circulation area.



The easiest way to put curves in any interior panel design

When designers want graceful
and sophisticated curved effects
they turn to SUPALINE.

This unique, decorative panel system lets
you quickly, easily and affordably create
smooth concave and convex designs —
or even S-curves— without ever worrying
about unsightly bulges.

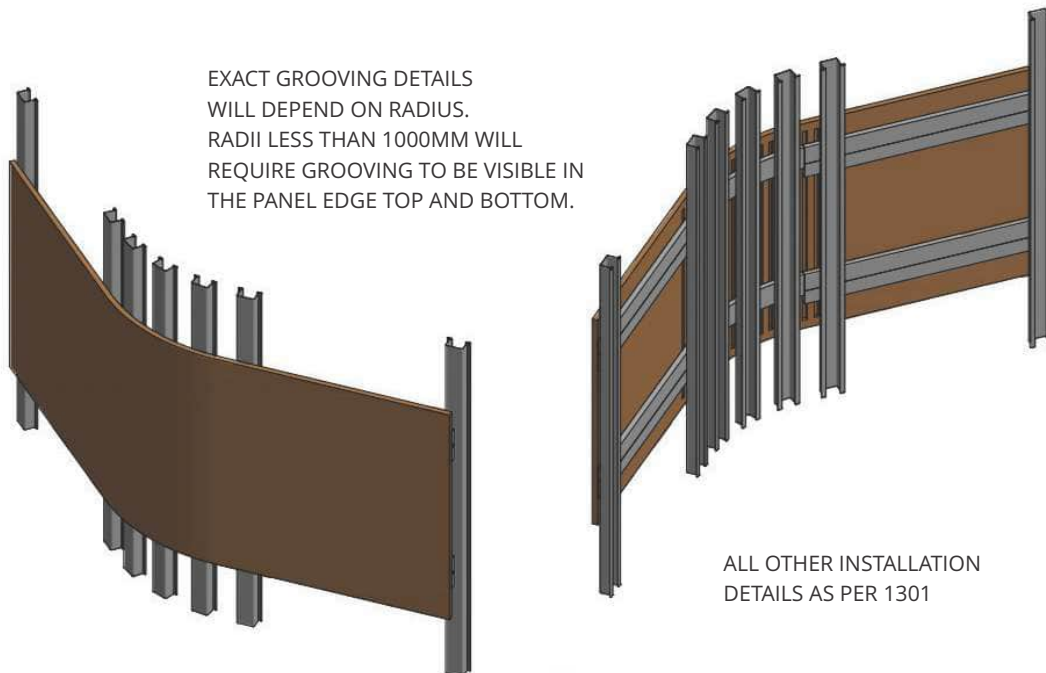

Access panels

- > Always include as part of the design process. Far more difficult to 'retro fit'.
- > Fully integrated access panels. Complete kit which includes concealed latch, hinges, escutcheon.

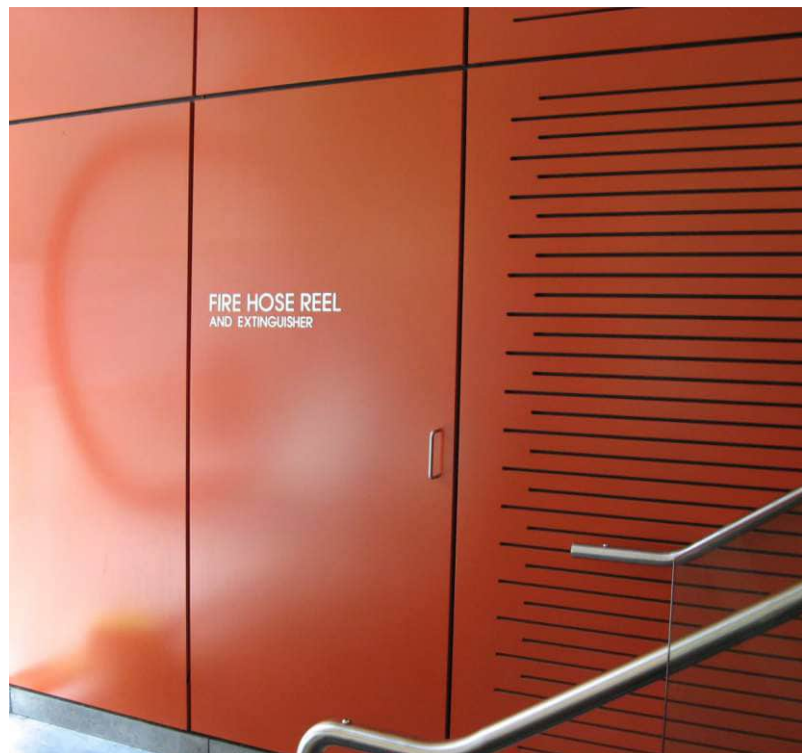
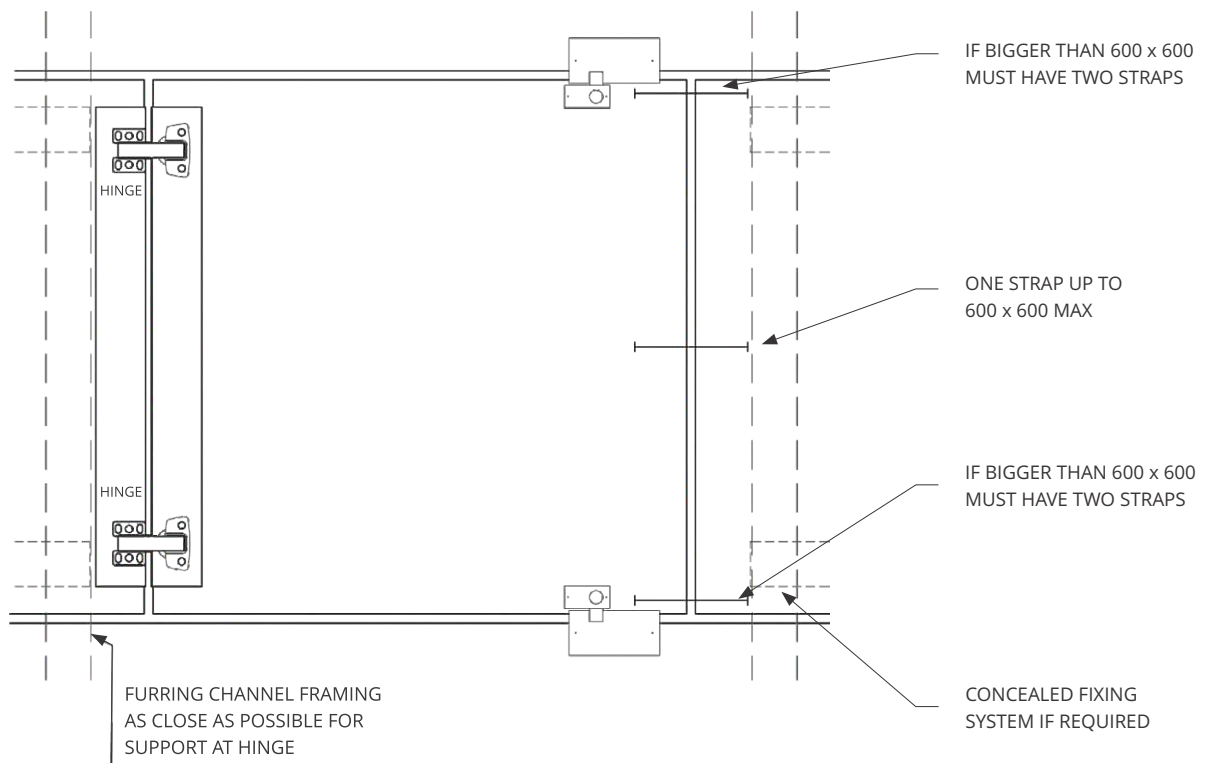



SUPA VENEER

natural timber finishes

There's nothing quite like natural timber veneers to create warmth, depth and aesthetic interest. But they also have a complex personality, capable of dramatic variations between batches.

SUPAWOOD can not only guide you through the potential pitfalls, our expertise can help identify correctly toned veneer options that are more economical than those veneer suppliers provide.

Highlights

- > Native, imported or reconstituted natural timber veneers
- > No on-site VOC's
- > Zero VOC emissions

SUPA VENEER

(NTV) Natural Timber Veneer

Fire Group 2 panel options available.



Hoop Pine CC



Tasmanian Oak 1/4



Blackbutt 1/4



American Oak CC



Spotted Gum 1/4

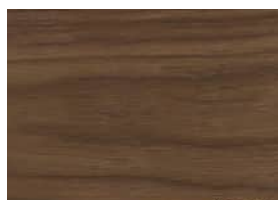

American Walnut CC



Midnight Black



or
any other
species

Your choice

If you can **imagine** it, it's possible with SUPALINE



▲ SUPAENEER form a curved wall in the foyer of a school performing arts theatre.

▼ SUPAENEER Anegre natural timber veneer panels create warmth in the multi-award winning library building of a girls school.

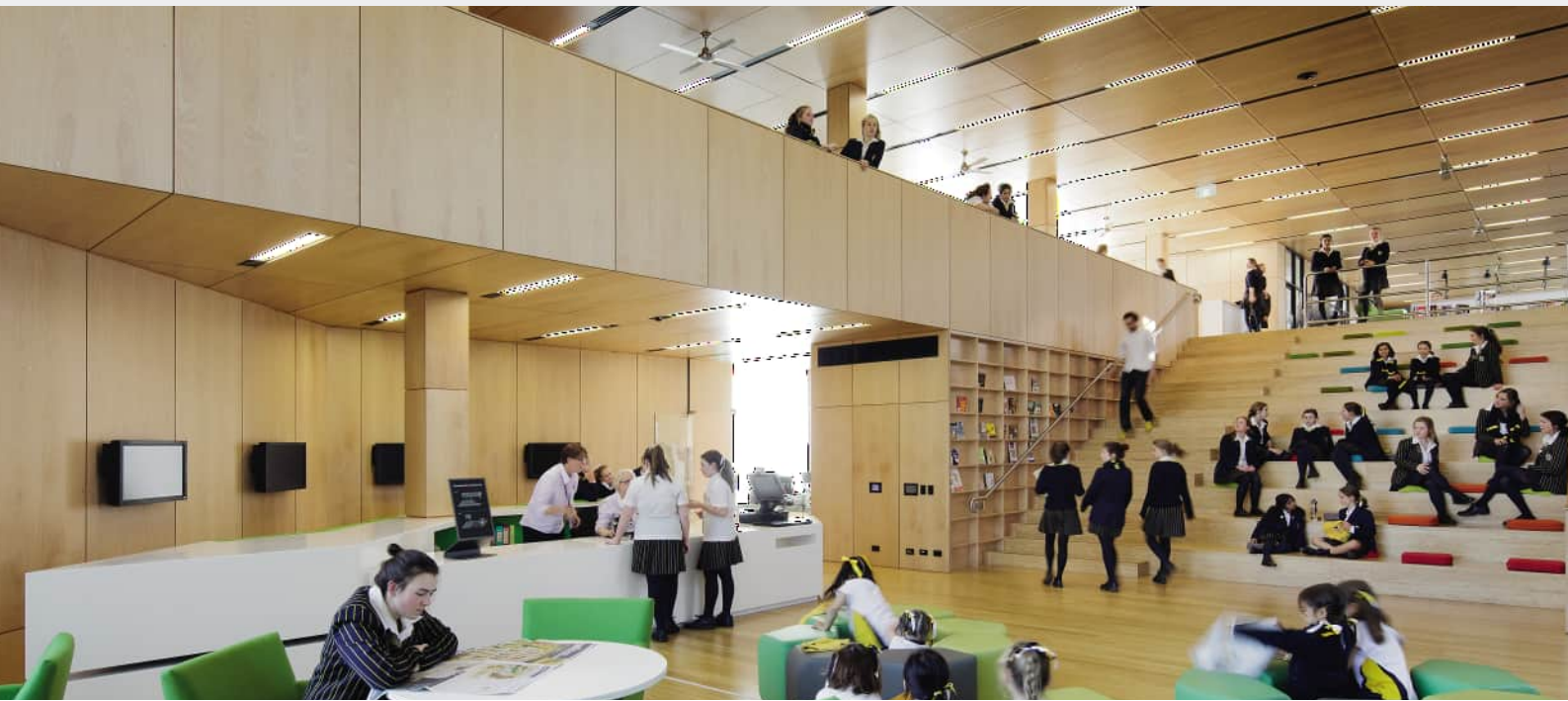

▼ SUPAENEER Hoop Pine offers a durable finish in the high traffic area of a university building. These panels were part of a project that won The Timber Development Association "Best Use of Decorative Veneers - National " and "Interior Fit-out-National" in 2009.

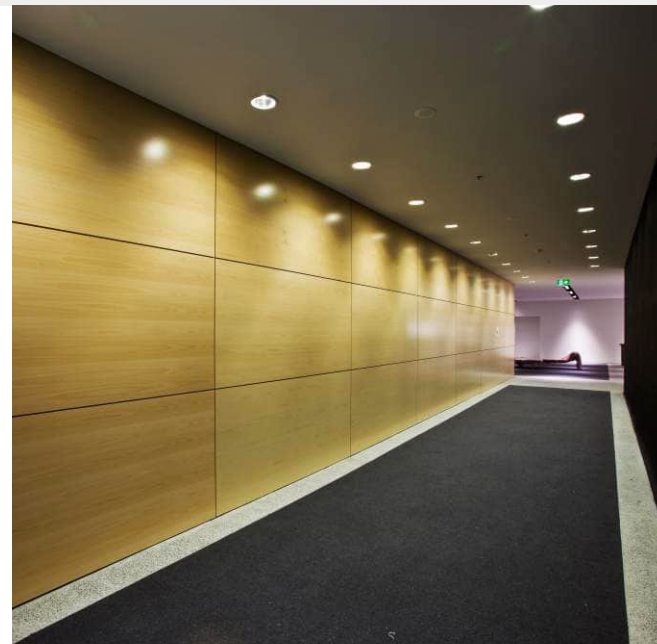
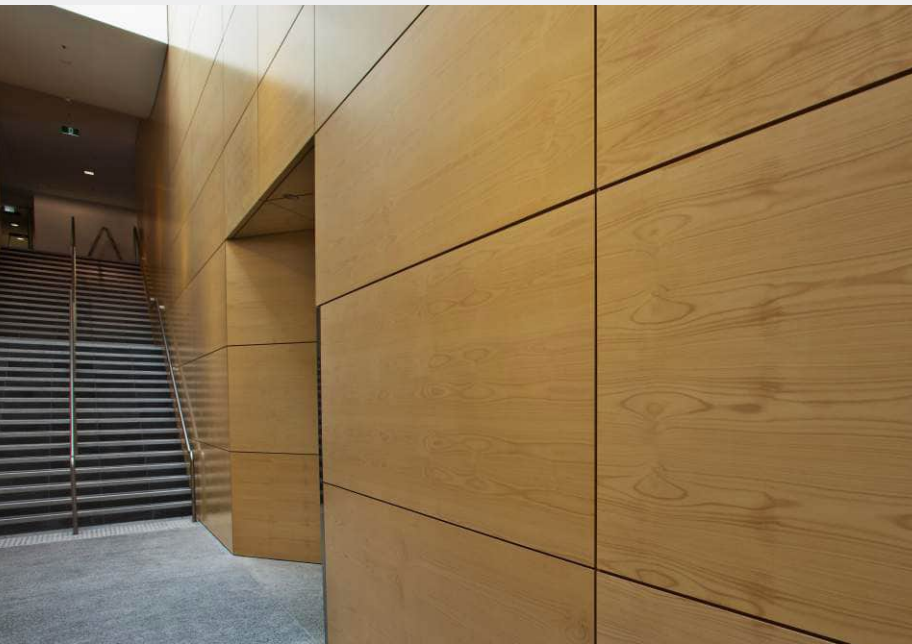

SUPATEXTURE

(ST) Tactile Woodgrains & Finishes



Limewash



Vic Ash

Tactile and highly durable this film is available across the full range of panels, slats, beams and blades and available in fire retardant configurations.

We're so confident in SUPATEXTURE we're offering a unique 30-year no hassle warranty.



Tasmanian Oak



Blackbutt



Spotted Gum

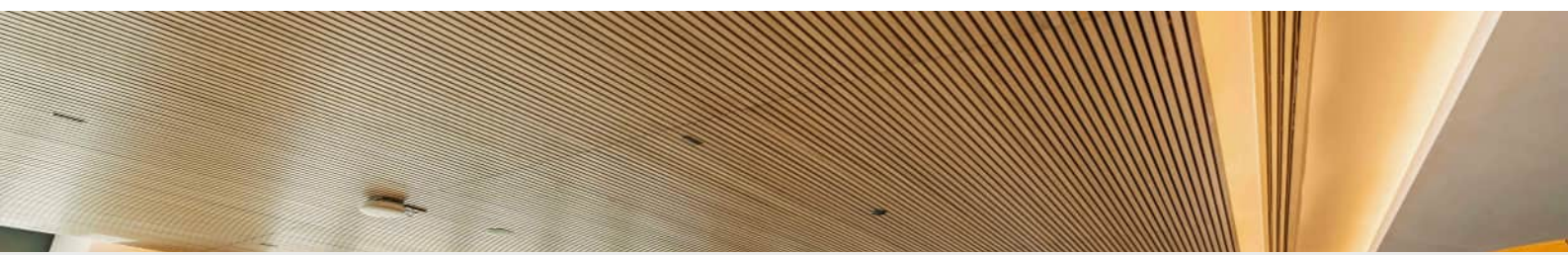

Laminates

Highlights

- > Economical without compromising quality
- > Extremely durable, impact resistant and easy to maintain
- > Apply to panel edge for a seamless square join
- > Timber veneer appearance without grain, shade and gloss variations
- > Zero VOC emissions

SUPAFINISH

(SF) Veneer & Coloured Laminates

Fire Group 1 and 2 options available.



Hoop Pine Limed SF



Fusion Maple SF



Hoop Pine Classic SF



Euro Beech SF



Tasmanian Oak SF



Blackbutt SF



Spotted Gum SF



Virgin Walnut SF

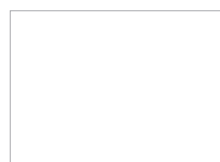

White SF

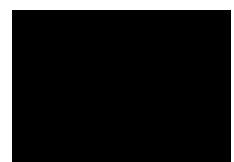

Black SF



▲ SUPAFINISH Tasmanian Oak feature wall and balustrade in a school theatre.



▲ St Marys Rugby Leagues Club



▲ Macquarie Uni Grad Hall



▲ Monte Sant' Angelo

▲ SUPAFINISH Hoop Pine wall panels create a spectacular stepped effect on the side walls of the theatre of a performing arts centre.



SUPACOLOUR

2-pack solid colour

SUPACOLOUR is our premium finishing system for solid colours.

We use qualified French Polishers with an average of more than 20 years spraying experience so finished panels are silky smooth to the touch, blemish-free, and have incredibly consistent gloss and colour levels.

Highlights

- > Choose any solid colour in any Australian paint selector range
- > 25 metallic finishes
- > Wide range of gloss levels
- > Resists abrasion, graffiti and dents
- > Easy-maintenance. wipe-clean surface
- > Does not fade due to age or light
- > No on-site VOC's
- > Zero VOC emissions

SUPACOLOUR

(SCR) Painted Finishes

Highly durable satin, high gloss and metallic finishes matched to any colour.
Fire Group 1 and 2 available.

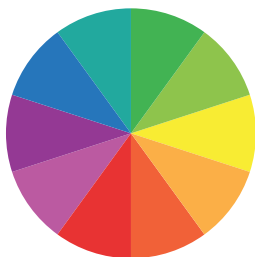

**MATCH TO
ANY COLOUR
REFERENCE**

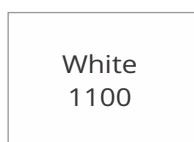

METALLIC COLOURS



Platinum

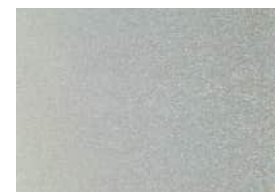

Silver



Antique Silver



Gold



Old Gold

If you can **imagine** it, it's possible with SUPALINE



▲ SUPACOLOUR panels in 3 shades of Red line one side of a passageway in a performing arts centre.

▼ SUPACOLOUR Metallic Gold panels used to create the faceted ceiling of an airport's luxury retail mall.



▲ SUPACOLOUR Satin White panels provide a durable entrance lobby to a commercial development while also reflecting light throughout the space.

▼ SUPACOLOUR panels form a Red curved pillar around the lift shaft in the foyer of a data centre.





CLICK HERE TO DOWNLOAD OUR
SUPACOUSTIC AND SUPALINE
DESIGN & DETAILING MANUAL

It's not easy to make your project stand out and satisfy performance, compliance and budget needs. We customise our systems to your requirements.

[DISCUSS YOUR PROJECT](#)

SUPAWOOD
ARCHITECTURAL LINING SYSTEMS

SUPAWOOD HEAD OFFICE
Australasian Support & Manufacturing
Aus: +61 1800 002 123
NZ: +64 (0) 9887 3234
info@supawood.com.au

SUPAWOOD UK
UK & EU Support & Manufacturing
+44 (0) 3307 00 00 30
sales@supawood.com.uk

Version 4.1

SUPAWOOD.COM.AU

Make Your Mark