

ANCILLARIES



FEATURES

FIRE RATED / INSULATED / TOTAL SYSTEM WARRANTY

UTILISATION

WALLS / CEILINGS / ROOF

APPLICATION

COMMERCIAL / INDUSTRIAL / ARCHITECTURAL / RESIDENTIAL

Panel Systems



EXTERIORS

Designed to provide insulated and air-tight connections, the ASKIN external wall and facade panel has had proven performance for decades. Its uses and abilities are only limited by the creativity and imagination of the designer.

INTERIORS

ASKIN performance panels internal walls and ceilings capture the very essence of modern architecture. Complimented by superior spanning and its pleasing aesthetic.

ROOFING

The ASKIN Roofing System is a fully integrated Ceiling & Insulated Roof "all-in-one". It is fast to install, weather tight and extremely thermally efficient. With key supply partners, ASKIN offer a range of skylights, trafficable access walkways and safety systems to complement our roofing systems.

DOORS

ASKIN's world class door manufacturing facilities supply a great range of insulated doors. Through continual innovation, our doors utilise energy-saving building techniques to maximize efficiency within your built environment.

SOLUTIONS

ASKIN embraces a holistic and practical approach in providing a total solution. This is encompassed by working with all parties to understand and develop the best practical solution.

Performance



SPECIFICATION

For any construction it is important to clearly define the materials and components. ASKIN has a wealth of experience matching insulated panel products to industrial applications. The ASKIN specification provides details on every aspect of your panel solution.

ENGINEERING

Building on fifty years of experience in technical construction, ASKIN, delivers world class performance and design to the commercial construction, processing and cold chain industries.

INSTALLATION

ASKIN installation provides a comprehensive range of construction and project management services. This installation is backed with ISO 9001 accreditation, and supported by a high standard of service and construction excellence.

MAINTENANCE

ASKIN maintenance can provide a full service and maintenance plan, that will extend your warranty, providing a whole of life solution.

LOGISTICS

Logistics have a nationwide footprint with local understanding and service capability. We are able to efficiently and effectively move materials, products and resources to meet our customers needs and timing.

OUR VALUES

ASKIN is a company driven by technological advancement which our clients experience through reliable performance in our products and services supported by industry experts with an exceptional level of personal dedication.

RELIABLE

- // Honesty in communication
- // Integrity in action
- // Quality in delivery
- // Consistent performance over time & space

KNOWLEDGABLE

- // Dedication to technological advancement
- // Knowledge driven teams
- // Know-how based expertise
- // Superior performance in products and people

PERSONALLY DEDICATED

- // Pride in achievements
- // Passion to exceed expectations
- // Commitment and loyalty to the company and clients

ACCESSIBLE

- // Family-feel the small business approach
- // Collaboration with partners & clients
- // Personable consultants
- // Direct action
- // Australian company



ABOUT US

ASKIN are the largest manufacturer and installer of insulated, fire rated and architectural facade systems, roofing systems and temperature controlled facilities in Australasia. With a network of 12 sites throughout Australia and New Zealand ASKIN's vast experience has been built upon a strong foundation dating back to 1964. ASKIN's culture of customer first, constant improvement, quality and safety assurance, supported with our technical expertise, and ISO9001 Accreditation.

With half a century of experience in the Performance Panel industry, ASKIN knows what you need to complete your controlled environment project. At ASKIN we stock and supply a full range of accessories, including sealants, fixings, suspension systems and pressure relief ports.

.....
"ASKIN Performance defines a unique level of service excellence based on cutting edge panel technology. The strength of the brand is derived from the sum of its parts: local organisations across Australia and New Zealand made up of highly dedicated individuals who work closely with their clients as specialists in their field, applying the most advanced panel technology to achieve exceptional results. This level of dedication and quality is captured by one word: PERFORMANCE."

Steve Clarke, Group Chief Executive Officer / Managing Director



ENVIRONMENTAL SUSTAINABILITY

At ASKIN we are passionate about environmental awareness and sustainability. We've been actively involved in reducing energy consumption through our sustainable construction systems and we supply a completely recyclable product to the market.

THE CARBON FOOTPRINT

Through the use of responsible design concepts in conjunction with XFLAM Insulated Panel Systems, consumers can reduce energy usage and aid in the reduction of greenhouse gas emissions. A system which boasts negative energy consumption balanced across the products lifecycle.

REDUCE, REUSE AND RECYCLE

Within our own business, we take our green credentials seriously, not only recycling and reconstituting the by-product, we are ISO 14001 accredited - Environmental Management System.

GREEN BUILDINGS

Ongoing energy savings are made year on year through outstanding climate control provided by the panel's continuous insulation properties, reducing heating, refrigeration and air conditioning costs. XFLAM insulation core can be recycled or re-manufactured at the end of its useful life.

DISCLAIMER

ASKIN makes every effort to maintain the accuracy and quality of the information provided in this catalogue. However, ASKIN cannot guarantee and assumes no legal liability or responsibility for the accuracy or completeness of the information provided. The information provided in this catalogue is for general guidance only. You should seek appropriate professional advice from ASKIN representatives on your particular circumstances as the application of the ancillaries listed in this book may vary depending on your particular circumstances.

Items in this catalogue may not be stocked in each location throughout Australia and New Zealand. These items will subsequently incur further lead times. Please check with your ASKIN representative for more information.

ASKIN reserves the right to amend the price of items outlined in this catalogue at any time without prior notice. Please check with your ASKIN representative for more information.

1	ALUMINIUM	PAGE 8
1.1	ANGLES	PAGE 8
1.2	CHANNELS	PAGE 11
1.3	COVING	PAGE 13
1.4	DOOR SECTIONS	PAGE 15
1.4.1	DOOR FRAMES	PAGE 15
1.4.2	DOOR GUIDES	PAGE 19
1.4.3	DOOR STAKES	PAGE 19
1.4.4	DOOR SEALS	PAGE 19
1.4.5	DOOR TRACKS	PAGE 19
1.4.6	DOOR TUBES	PAGE 20
1.5	JOINERS	PAGE 21
1.5.1	JOINER MOULDS	PAGE 21
1.5.2	LEEROY	PAGE 21
1.5.3	T-SECTIONS	PAGE 21
1.6	FLAT BAR	PAGE 22
1.7	BOX SECTIONS	PAGE 24
1.7.1	RHS	PAGE 24
1.7.2	SHS	PAGE 24
1.8	TOP HATS	PAGE 25
1.9	BUMP RAILS	PAGE 26
2	STEEL	PAGE 28
2.1	STEEL SECTIONS	PAGE 28
2.1.1	ANGLES	PAGE 28
2.1.2	CHANNELS	PAGE 28
2.1.3	CLIPS	PAGE 29
2.1.4	TOP HAT BATTENS	PAGE 29
2.1.5	SHS	PAGE 29
2.1.6	RHS	PAGE 29
2.2	FLASHINGS	PAGE 30
2.2.1	ANGLES	PAGE 30
2.2.2	CHANNELS	PAGE 31
2.2.3	COVING	PAGE 31
2.2.4	FLAT	PAGE 32
2.2.5	T-SECTIONS	PAGE 32
2.3	PELMETS	PAGE 33
3	PVC	PAGE 34
3.1	ANGLES	PAGE 34
3.2	CHANNELS	PAGE 34
3.3	JOINERS	PAGE 34
3.4	PACKERS	PAGE 34
3.5	STRIPS	PAGE 35
3.6	TUBES	PAGE 35
4	SHEETS	PAGE 36
4.1	XFLAM	PAGE 36
4.2	PIR	PAGE 36
4.3	EPS	PAGE 36
4.4	XPS	PAGE 37
4.5	PUR	PAGE 38
4.6	POLYTHENE	PAGE 38
4.7	PVC	PAGE 38

4.8	FOREX	PAGE 38
4.9	STEEL	PAGE 38
4.10	ALUMINIUM	PAGE 39
4.11	TIMBER	PAGE 39
5	SUSPENSION COMPONENTS	PAGE 40
5.1	COMPONENTS	PAGE 40
5.1.1	BEAM CLAMPS	PAGE 40
5.1.2	BRACKETS	PAGE 40
5.1.3	CHAINS	PAGE 40
5.1.4	CLIPS	PAGE 40
5.1.5	PLATES	PAGE 40
5.1.6	GRIPPLES	PAGE 40
5.1.7	TURNBUCKLE	PAGE 41
5.1.8	D-SHAKLE	PAGE 41
5.1.9	CABLE CLIP	PAGE 41
5.1.10	MUSHROOM HEADS	PAGE 41
5.1.11	WIRE KITS	PAGE 42
5.1.12	THREADED RODS	PAGE 43
5.2	SUSPENSION KITS	PAGE 44
6	DOOR ACCESSORIES	PAGE 45
6.1	SWING DOOR ACCESSORIES	PAGE 45
6.1.1	CLOSERS	PAGE 45
6.1.2	HANDLES/LOCKS/LATCHES	PAGE 46
6.1.3	HINGES	PAGE 50
6.1.4	MISCELLANEOUS	PAGE 51
6.2	SLIDING DOOR ACCESSORIES	PAGE 52
6.2.1	HANDLES/LATCHES	PAGE 52
6.2.2	DOOR STOPS	PAGE 55
6.2.3	DOOR GUIDES	PAGE 57
6.2.4	DOOR ROLLERS	PAGE 57
6.2.5	LABELS	PAGE 61
6.3	UNIVERSAL DOOR ACCESSORIES	PAGE 62
6.3.1	GASKETS	PAGE 62
6.3.2	HEATING	PAGE 64
6.3.3	DOOR BELL COMPONENTS	PAGE 64
7	WINDOWS	PAGE 65
8	PRESSURE RELIEF PORTS	PAGE 66
9	FIXINGS	PAGE 68
9.1	RIVETS	PAGE 68
9.2	ROOFING SCREWS	PAGE 69
9.3	ROOF ANCHOR	PAGE 70
9.4	CONCRETE FASTENERS	PAGE 71
9.5	BOLTS, NUTS & WASHERS	PAGE 71
9.6	SCREWS	PAGE 75
9.7	DRILL BITS & BLADES	PAGE 76
10	ADHESIVES & PAINTS	PAGE 77
10.1	EXPANDABLE FOAMS	PAGE 77
10.2	SEALANTS	PAGE 77
10.3	TAPES & PAINTS	PAGE 78
10.4	VAPOUR BARRIERS	PAGE 78

1 ALUMINIUM

1.1 ANGLES

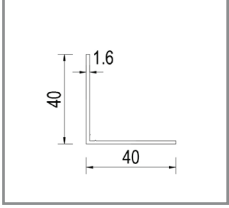
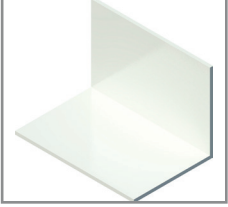
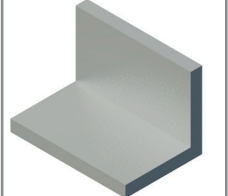
		Description:	Finish:	Item code:	Unit:	Price:
		12x12x1.2mm Angle at 6500mm lengths	Sufmist Mill Custom	10100000 10100001	lgth	\$ _____ \$ _____ \$ _____
		20x20x1.5mm Angle at 6500mm lengths	Sufmist Mill Custom	10100050 10100051	lgth	\$ _____ \$ _____ \$ _____
		25x12x1.6mm Angle at 6500mm lengths with V groove	Sufmist Mill Custom	10100100 10100101	lgth	\$ _____ \$ _____ \$ _____
		25x25x1.6mm Angle at 6500mm lengths	Sufmist Mill Custom	10100150 10100151	lgth	\$ _____ \$ _____ \$ _____
		35x35x1.6mm Angle at 6500mm lengths	Sufmist Mill Custom	10100200 10100201	lgth	\$ _____ \$ _____ \$ _____
		40x40x1.6mm Angle at 6500mm lengths with V groove	Sufmist Mill Custom	10100250 10100251	lgth	\$ _____ \$ _____ \$ _____
		40x40x1.6mm Angle at 6500mm lengths	Sufmist Mill Custom	10100300 10100301	lgth	\$ _____ \$ _____ \$ _____
		40x40x6mm Angle at 6500mm lengths	Mill Custom	10100351	lgth	\$ _____ \$ _____



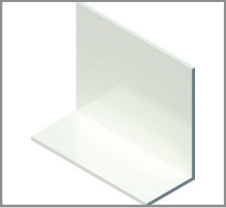
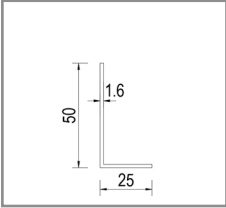
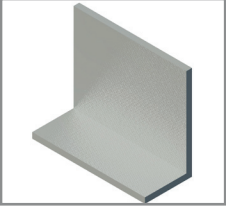
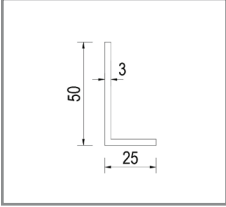
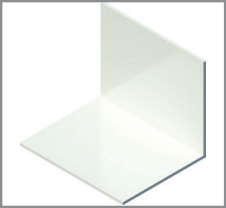
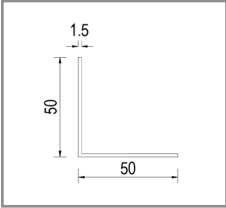
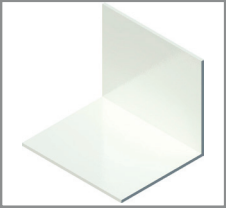
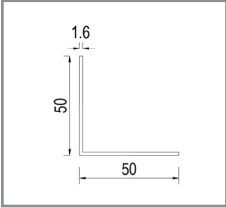
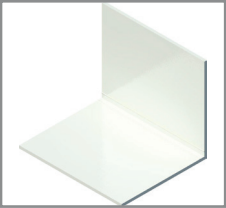
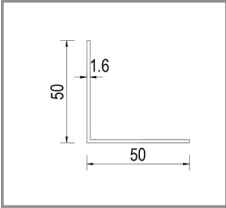
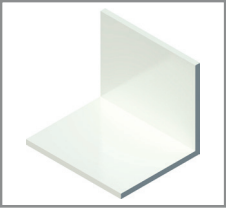
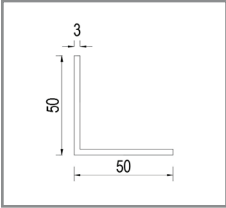
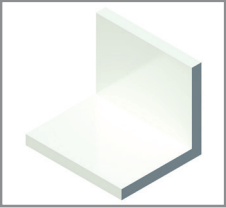
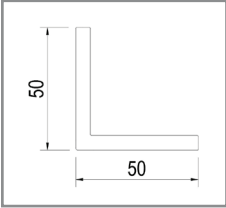
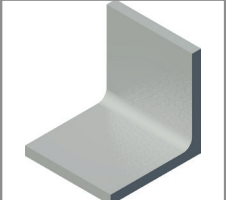
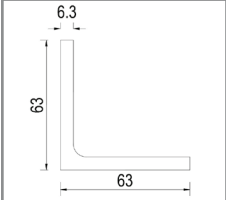

1 ALUMINIUM

1.1 ANGLES CONTINUED

		Description:	Finish:	Item code:	Unit:	Price:
		50x25x1.6mm Angle at 6500mm lengths	Sufmist Mill Custom	10100400 10100401	lgth lgth lgth	\$ _____ \$ _____ \$ _____
		50x25x3mm Angle at 6500mm lengths	Mill Custom	10100451	lgth lgth	\$ _____ \$ _____
		50x50x1.5mm Angle at 6500mm lengths	Sufmist Mill Custom	10100500 10100501	lgth lgth lgth	\$ _____ \$ _____ \$ _____
		50x50x1.6mm Angle at 6500mm lengths	Sufmist Mill Custom	10100550 10100551	lgth lgth lgth	\$ _____ \$ _____ \$ _____
		50x50x1.6mm Angle at 6500mm lengths with V groove	Sufmist Mill Custom	10100600 10100601	lgth lgth lgth	\$ _____ \$ _____ \$ _____
		50x50x3mm Angle at 6500mm lengths	Sufmist Mill Custom	10100650 10100651	lgth lgth lgth	\$ _____ \$ _____ \$ _____
		50x50x6mm Angle at 6500mm lengths	Sufmist Mill Custom	10100700 10100701	lgth lgth lgth	\$ _____ \$ _____ \$ _____
		63x63x6.3mm Angle at 6500mm lengths with rounded corner	Mill Custom	10100750	lgth lgth	\$ _____ \$ _____

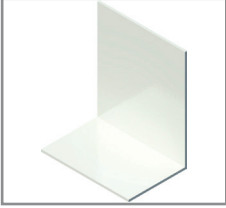
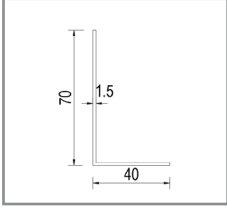
1 ALUMINIUM

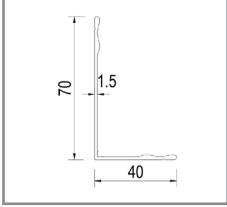
1.1 ANGLES CONTINUED

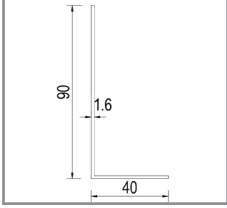
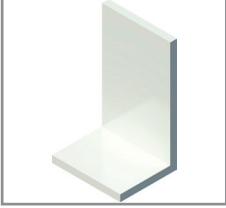
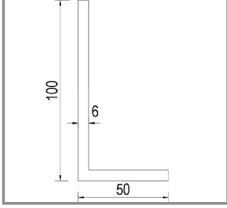
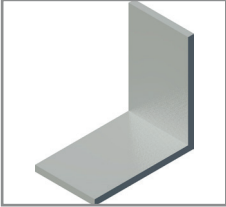
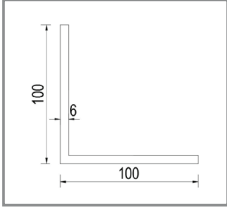
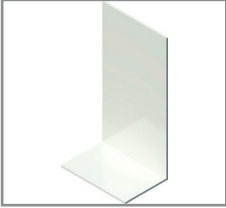
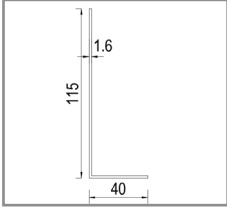
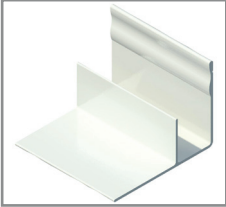
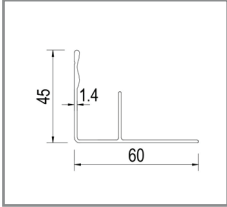
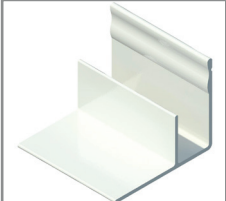
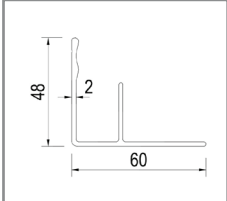
		Description:	Finish:	Item code:	Unit:	Price:
		70x40x1.5mm Angle at 6500mm lengths	Surfmist Mill Custom	10100800 10100801	lgth lgth lgth	\$ _____ \$ _____ \$ _____
		70x40x1.5mm Angle at 6500mm lengths with V groove	Surfmist Mill Custom	10100850 10100851	lgth lgth lgth	\$ _____ \$ _____ \$ _____
		90x40x1.6mm Angle at 6500mm lengths	Surfmist Mill Custom	10100900 10100901	lgth lgth lgth	\$ _____ \$ _____ \$ _____
		100x50x6mm Angle at 6500mm lengths	Surfmist Mill Custom	10100950 10100951	lgth lgth lgth	\$ _____ \$ _____ \$ _____
		100x100x6mm Angle at 6500mm lengths	Mill Custom	10101000	lgth lgth	\$ _____ \$ _____
		115x40x1.6mm Angle at 6500mm lengths	Surfmist Mill Custom	10101050 10101051	lgth lgth lgth	\$ _____ \$ _____ \$ _____
		45x60x1.4mm F-Mould at 6500mm lengths	Surfmist Mill Custom	10101150 10101151	lgth lgth lgth	\$ _____ \$ _____ \$ _____
		48x60x2mm F-Mould at 5800mm lengths	Sufmist Mill Custom	10101200 10101201	lgth lgth lgth	\$ _____ \$ _____ \$ _____







1 ALUMINIUM

1.2 CHANNELS

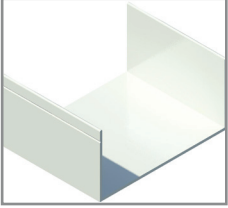
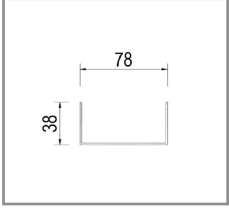
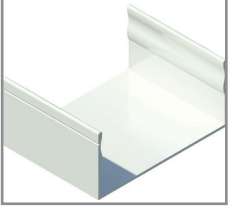
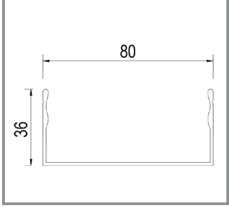
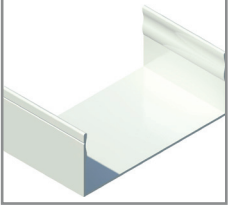
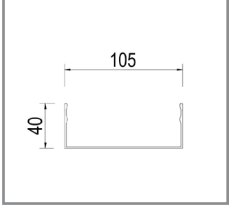
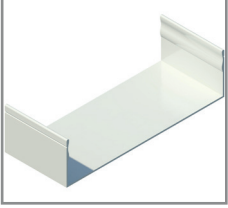
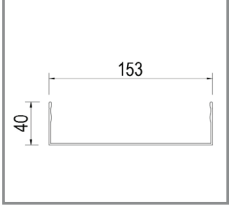
		Description:	Finish:	Item code:	Unit:	Price:
		12x12x1.6mm Channel at 6500mm lengths	Surfmist Mill Custom	10101250 10101251	lgth lgth lgth	\$ _____ \$ _____ \$ _____
		16x16x1.6mm Channel at 6500mm lengths	Surfmist Mill Custom	10101300 10101301	lgth lgth lgth	\$ _____ \$ _____ \$ _____
		20x16x1.6mm Channel at 6500mm lengths	Surfmist Mill Custom	10101350 10101351	lgth lgth lgth	\$ _____ \$ _____ \$ _____
		32x25x3mm Channel at 6500mm lengths	Surfmist Mill Custom	10101400 10101401	lgth lgth lgth	\$ _____ \$ _____ \$ _____
		50x20x1.2mm Channel at 6500mm lengths	Surfmist Mill Custom	10101500 10101501	lgth lgth lgth	\$ _____ \$ _____ \$ _____
		50x25x3mm Channel at 6500mm lengths with V groove	Surfmist Mill Custom	10101550 10101551	lgth lgth lgth	\$ _____ \$ _____ \$ _____
		53x25x1.2mm Channel at 6500mm lengths with V groove	Surfmist Mill Custom	10101600 10101601	lgth lgth lgth	\$ _____ \$ _____ \$ _____
		56x30x1.5mm Channel at 6500mm lengths with V groove	Surfmist Mill Custom	10101650 10101651	lgth lgth lgth	\$ _____ \$ _____ \$ _____

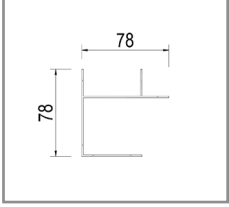
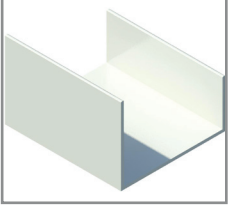
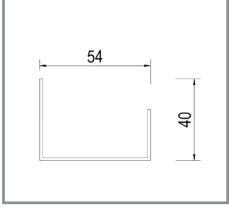

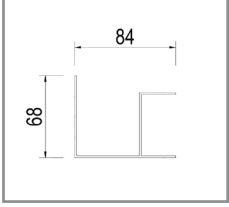

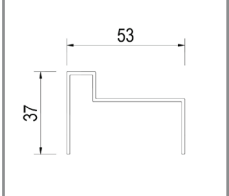
1 ALUMINIUM

1.2 CHANNELS CONTINUED

		Description:	Finish:	Item code:	Unit:	Price:
		75x38x1.5mm Channel at 6500mm lengths with V groove	Surfmist Mill Custom	10101700 10101701	lgth	\$ _____ \$ _____ \$ _____
		75x36x1.4mm Channel at 6500mm lengths with V groove	Surfmist Mill Custom	10101750 10101751	lgth	\$ _____ \$ _____ \$ _____
		105x40x1.4mm Channel at 6500mm lengths with V groove	Surfmist Mill Custom	10101800 10101801	lgth	\$ _____ \$ _____ \$ _____
		153x40x1.4mm Channel at 6500mm lengths with V groove	Surfmist Mill Custom	10101850 10101851	lgth	\$ _____ \$ _____ \$ _____
		Annex Channel at 6500mm lengths	Surfmist Mill Custom	10101900 10101901	lgth	\$ _____ \$ _____ \$ _____
		Uneven Channel at 6500mm lengths	Surfmist Mill Custom	10101950 10101951	lgth	\$ _____ \$ _____ \$ _____
		CHAGUT50 Channel at 6500mm lengths	Surfmist Mill Custom	10102000 10102001	lgth	\$ _____ \$ _____ \$ _____
		Door Stop & Floor Channel at 6500mm lengths	Surfmist Mill Custom	10102050 10102051	lgth	\$ _____ \$ _____ \$ _____

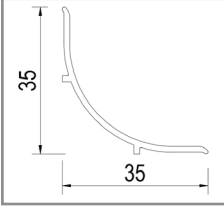
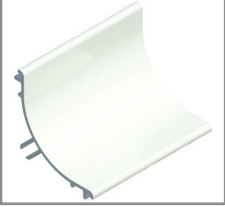
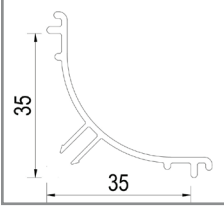
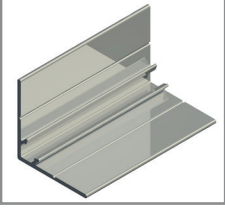
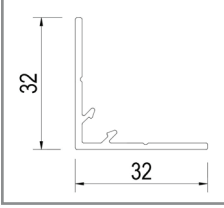
1 ALUMINIUM

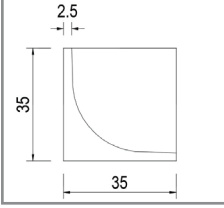
1.3 COVING

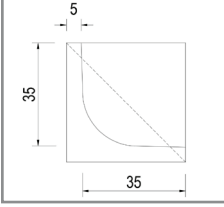
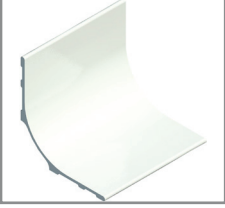
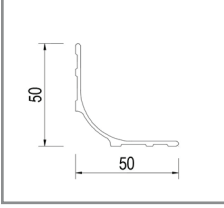
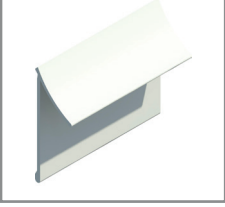
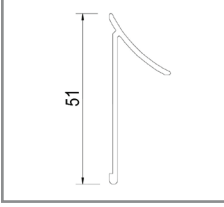
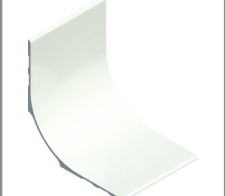
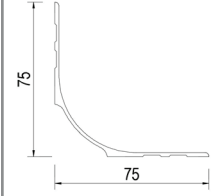
		Description:	Finish:	Item code:	Unit:	Price:
		35mm Coving Light at 6500mm lengths	Surfmist Mill Custom	10102100 10102101	lgth lgth lgth	\$ _____ \$ _____ \$ _____
		35mm Snap on Cove Male at 6500mm lengths	Surfmist Mill Custom	10102150 10102151	lgth lgth lgth	\$ _____ \$ _____ \$ _____
		35mm Snap to Cove Female at 6500mm lengths	Mill	10102199	lgth	\$ _____
		35mm Block Coving	Surfmist Mill Custom	10102200 10102201	ea ea ea	\$ _____ \$ _____ \$ _____
		35mm Snap Block Coving	Surfmist Mill Custom	10102250 10102251	ea ea ea	\$ _____ \$ _____ \$ _____
		50mm Coving at 6500mm lengths	Surfmist Mill Custom	10102350 10102351	lgth lgth lgth	\$ _____ \$ _____ \$ _____
		Arrowhead Coving at 6500mm lengths	Surfmist Mill Custom	10102400 10102451	lgth lgth lgth	\$ _____ \$ _____ \$ _____
		75mm Coving at 6500mm lengths	Surfmist Mill Custom	10102500 10102501	lgth lgth lgth	\$ _____ \$ _____ \$ _____

1 ALUMINIUM

1.3 COVING CONTINUED

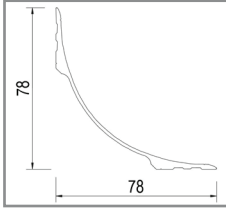
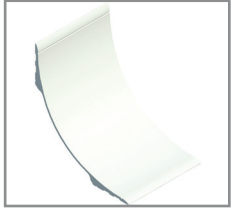

Description:
78mm Coving
at 6500mm lengths

Finish:	Item code:	Unit:	Price:
Surfmist	10102550	lgth	\$ _____
Mill	10102551	lgth	\$ _____
Custom		lgth	\$ _____

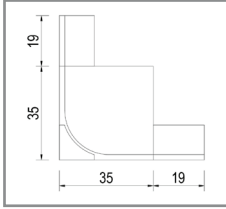

35mm Radius Cove Corner Block

Surfmist	10102600	ea	\$ _____
Mill	10102601	ea	\$ _____
Custom		ea	\$ _____

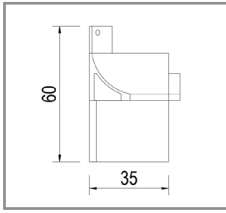
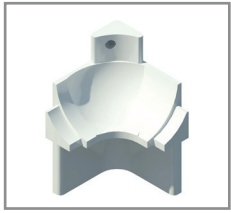

35mm Arrowhead Corner Block

Surfmist	10102650	ea	\$ _____
Mill	10102651	ea	\$ _____
Custom		ea	\$ _____

1 ALUMINIUM

1.4 DOOR SECTIONS

		1.4.1	FRAMES			
		Description:	Finish:	Item code:	Unit:	Price:
		80mm Split Frame Architrave Part 1 at 6500mm lengths	Surfmist Custom	10102850	lgth lgth	\$ _____ \$ _____
		80mm Split Frame Cap Part 2 at 6500mm lengths	Surfmist Custom	10102900	lgth lgth	\$ _____ \$ _____
		80mm Split Frame Angle Part 3 at 6500mm lengths	Surfmist Custom	10102950	lgth lgth	\$ _____ \$ _____
		Door Chair Snap Bead Part 1 at 6500mm lengths	Surfmist Custom	10103000	lgth lgth	\$ _____ \$ _____
		Door Chair Base Part 2 at 6500mm lengths	Surfmist Custom	10103050	lgth lgth	\$ _____ \$ _____
		55mm Split Frame Architrave Part 1 at 6500mm lengths	Surfmist Custom	10102700	lgth lgth	\$ _____ \$ _____
		55mm Split Frame Cap Part 2 at 6500mm lengths	Surfmist Custom	10102750	lgth lgth	\$ _____ \$ _____
		55mm Split Frame Angle Part 3 at 6500mm lengths	Surfmist Custom	10102800	lgth lgth	\$ _____ \$ _____

1 ALUMINIUM

1.4 DOOR SECTIONS CONTINUED

		1.4.1	FRAMES			
		Description:	Finish:	Item code:	Unit:	Price:
		105x62x2mm Thermal Break Extrusion 100mm Semi Rebate Face Door at 6500mm lengths	Surfmist Custom	10103100	Igth Igth	\$ _____ \$ _____
		38mm Door Channel 100mm PA Door - Part 1 at 6500mm lengths 4mm Stake	Surfmist Custom	10103150	Igth Igth	\$ _____ \$ _____
		38mm Radius Door Base Channel Part 2 at 6500mm lengths 4mm Stake	Surfmist Custom	10103200	Igth Igth	\$ _____ \$ _____
		38mm Radius Door Channel Old Part 1 at 6500mm lengths 6mm Stake	Surfmist Custom	10103250	Igth Igth	\$ _____ \$ _____
		59x52x1.6mm Angle Z Extrusion 100mm Wedge Door - Part 2 at 6500mm lengths	Surfmist Custom	10103300	Igth Igth	\$ _____ \$ _____
		38mm Door Jamb Channel in 50mm at 6500mm lengths	Surfmist Custom	10103350	Igth Igth	\$ _____ \$ _____
		38mm Door Jamb Channel in 75mm at 6500mm lengths	Surfmist Custom	10103400	Igth Igth	\$ _____ \$ _____
		38mm Door Jamb Channel in 100mm at 6500mm lengths	Surfmist Custom	10103450	Igth Igth	\$ _____ \$ _____

1 ALUMINIUM

1.4 DOOR SECTIONS CONTINUED

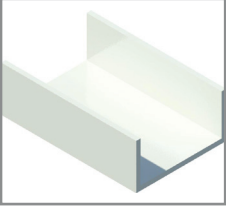
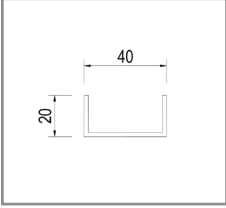
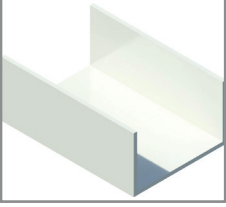
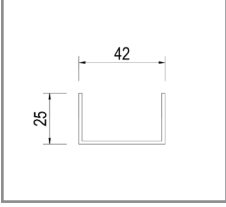
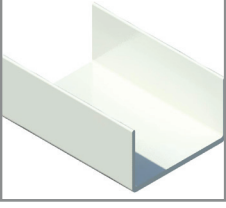
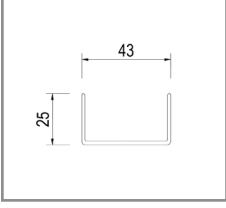
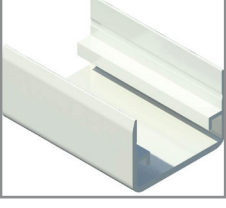
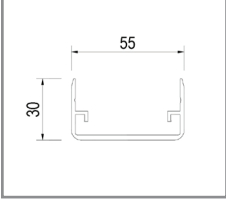
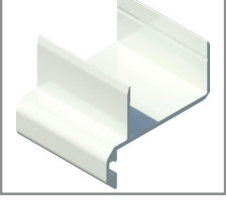
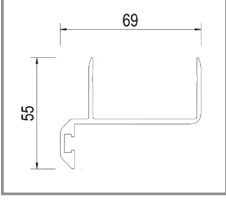
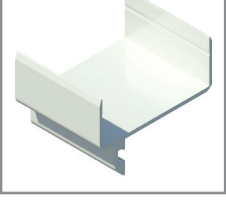
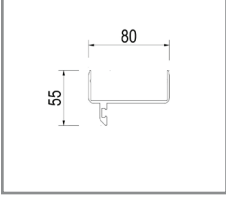
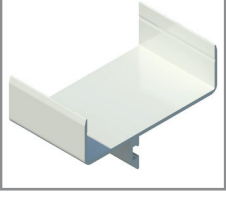
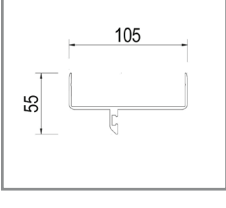
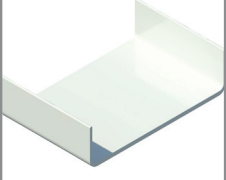
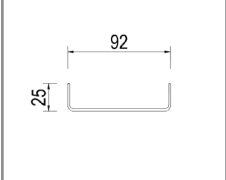
		1.4.1	FRAMES			
		Description:	Finish:	Item code:	Unit:	Price:
		40x20x2mm Door Channel at 6500mm lengths	Surfmist Custom	10103500	lgth lgth	\$ _____ \$ _____
		42x25x1.6mm Door Channel at 6500mm lengths	Surfmist Custom	10103550	lgth lgth	\$ _____ \$ _____
		43x25x1.4mm Door Channel at 6500mm lengths	Surfmist Custom	10103600	lgth lgth	\$ _____ \$ _____
		50mm Radius Door Channel at 6500mm lengths	Surfmist Custom	10103650	lgth lgth	\$ _____ \$ _____
		50mm Door Jamb Channel for 50mm wall panel at 6500mm lengths	Surfmist Custom	10103700	lgth lgth	\$ _____ \$ _____
		50mm Door Jamb Channel for 75mm wall panel at 6500mm lengths	Surfmist Custom	10103750	lgth lgth	\$ _____ \$ _____
		50mm Door Jamb Channel for 100mm wall panel at 6500mm lengths	Surfmist Custom	10103800	lgth lgth	\$ _____ \$ _____
		92x25x2.5x1.5mm Door Channel at 6500mm lengths with radius edge	Surfmist Custom	10103850	lgth lgth	\$ _____ \$ _____

1 ALUMINIUM

1.4 DOOR SECTIONS CONTINUED

		1.4.1	FRAMES			
		Description:	Finish:	Item code:	Unit:	Price:
		117x25x3x1.5mm Door Channel at 6500mm lengths with radius edge	Surfmist Custom	10103900	lgth lgth	\$ _____ \$ _____
		168x25x3.2x1.5mm Door Channel at 6500mm lengths with radius edge	Surfmist Custom	10103950	lgth lgth	\$ _____ \$ _____
		92x25x2x3mm Door Channel at 6500mm lengths with square edge	Surfmist Mill Custom	10104000 10104001	lgth lgth lgth	\$ _____ \$ _____ \$ _____
		118x25x2x3mm Door Channel at 6500mm lengths with square edge	Surfmist Custom	10104050	lgth lgth	\$ _____ \$ _____
		168x25x3.2x1.5mm Door Channel at 6500mm lengths with square edge	Surfmist Custom	10104100	lgth lgth	\$ _____ \$ _____
		50mm Flanged Channel at 6500mm lengths	Surfmist Mill Custom	10104150 10104151	lgth lgth lgth	\$ _____ \$ _____ \$ _____
		21x13mm Door Stop Extrusion at 6500mm lengths	Surfmist Mill Custom	10104200 10104201	lgth lgth lgth	\$ _____ \$ _____ \$ _____

1 ALUMINIUM

1.4 DOOR SECTIONS CONTINUED

		<p>1.4.2</p> <p>Description: 75mm Door Floor Guide at 6500mm lengths</p>	<p>GUIDES - FLOOR</p> <table border="1"> <thead> <tr> <th>Finish:</th> <th>Item code:</th> <th>Unit:</th> <th>Price:</th> </tr> </thead> <tbody> <tr> <td>Surfmist</td> <td>10104250</td> <td>lgth</td> <td>\$ _____</td> </tr> <tr> <td>Mill</td> <td>10104251</td> <td>lgth</td> <td>\$ _____</td> </tr> <tr> <td>Custom</td> <td></td> <td>lgth</td> <td>\$ _____</td> </tr> </tbody> </table>				Finish:	Item code:	Unit:	Price:	Surfmist	10104250	lgth	\$ _____	Mill	10104251	lgth	\$ _____	Custom		lgth	\$ _____
Finish:	Item code:	Unit:	Price:																			
Surfmist	10104250	lgth	\$ _____																			
Mill	10104251	lgth	\$ _____																			
Custom		lgth	\$ _____																			
		<p>150mm Door Floor Guide at 6500mm lengths</p>	<table border="1"> <tbody> <tr> <td>Surfmist</td> <td>10104300</td> <td>lgth</td> <td>\$ _____</td> </tr> <tr> <td>Mill</td> <td>10104301</td> <td>lgth</td> <td>\$ _____</td> </tr> <tr> <td>Custom</td> <td></td> <td>lgth</td> <td>\$ _____</td> </tr> </tbody> </table>				Surfmist	10104300	lgth	\$ _____	Mill	10104301	lgth	\$ _____	Custom		lgth	\$ _____				
Surfmist	10104300	lgth	\$ _____																			
Mill	10104301	lgth	\$ _____																			
Custom		lgth	\$ _____																			
		<p>1.4.2</p> <p>Description: Chair Section at 6500mm lengths</p>	<p>GUIDES - WALL</p> <table border="1"> <thead> <tr> <th>Finish:</th> <th>Item code:</th> <th>Unit:</th> <th>Price:</th> </tr> </thead> <tbody> <tr> <td>Mill</td> <td>10104351</td> <td>ea</td> <td>\$ _____</td> </tr> <tr> <td>Custom</td> <td></td> <td>ea</td> <td>\$ _____</td> </tr> </tbody> </table>				Finish:	Item code:	Unit:	Price:	Mill	10104351	ea	\$ _____	Custom		ea	\$ _____				
Finish:	Item code:	Unit:	Price:																			
Mill	10104351	ea	\$ _____																			
Custom		ea	\$ _____																			
		<p>1.4.3</p> <p>Description: 50x50x6mm Pre-Tapped Stake Suit 6mm Split Frame Set at 13mm width</p>	<p>STAKES</p> <table border="1"> <thead> <tr> <th>Finish:</th> <th>Item code:</th> <th>Unit:</th> <th>Price:</th> </tr> </thead> <tbody> <tr> <td>Mill</td> <td>10104400</td> <td>ea</td> <td>\$ _____</td> </tr> </tbody> </table>				Finish:	Item code:	Unit:	Price:	Mill	10104400	ea	\$ _____								
Finish:	Item code:	Unit:	Price:																			
Mill	10104400	ea	\$ _____																			
		<p>50x50mm Stake at 4mm width</p>	<table border="1"> <tbody> <tr> <td>Mill</td> <td>10104401</td> <td>ea</td> <td>\$ _____</td> </tr> </tbody> </table>				Mill	10104401	ea	\$ _____												
Mill	10104401	ea	\$ _____																			
		<p>50x50mm Stake at 6mm width</p>	<table border="1"> <tbody> <tr> <td>Mill</td> <td>10104402</td> <td>ea</td> <td>\$ _____</td> </tr> </tbody> </table>				Mill	10104402	ea	\$ _____												
Mill	10104402	ea	\$ _____																			
		<p>1.4.4</p> <p>Description: Drip Mould at 1250mm lengths</p>	<p>SEALS</p> <table border="1"> <thead> <tr> <th>Finish:</th> <th>Item code:</th> <th>Unit:</th> <th>Price:</th> </tr> </thead> <tbody> <tr> <td>Black</td> <td>10104410</td> <td>lgth</td> <td>\$ _____</td> </tr> </tbody> </table>				Finish:	Item code:	Unit:	Price:	Black	10104410	lgth	\$ _____								
Finish:	Item code:	Unit:	Price:																			
Black	10104410	lgth	\$ _____																			
		<p>Drip Mould at 2000mm lengths</p>	<table border="1"> <tbody> <tr> <td>Black</td> <td>10104411</td> <td>lgth</td> <td>\$ _____</td> </tr> </tbody> </table>				Black	10104411	lgth	\$ _____												
Black	10104411	lgth	\$ _____																			
		<p>Batwing Double Door Seal at 2500mm lengths</p>	<table border="1"> <tbody> <tr> <td>Surfmist</td> <td>10106700</td> <td>lgth</td> <td>\$ _____</td> </tr> <tr> <td>Custom</td> <td></td> <td></td> <td></td> </tr> </tbody> </table>				Surfmist	10106700	lgth	\$ _____	Custom											
Surfmist	10106700	lgth	\$ _____																			
Custom																						
		<p>Batwing Double Door Seal at 3000mm lengths</p>	<table border="1"> <tbody> <tr> <td>Surfmist</td> <td>10106750</td> <td>lgth</td> <td>\$ _____</td> </tr> <tr> <td>Custom</td> <td></td> <td></td> <td></td> </tr> </tbody> </table>				Surfmist	10106750	lgth	\$ _____	Custom											
Surfmist	10106750	lgth	\$ _____																			
Custom																						
		<p>1.4.5</p> <p>Description: G Track at 6500mm lengths</p>	<p>TRACKS</p> <table border="1"> <thead> <tr> <th>Finish:</th> <th>Item code:</th> <th>Unit:</th> <th>Price:</th> </tr> </thead> <tbody> <tr> <td>Surfmist</td> <td>10104450</td> <td>lgth</td> <td>\$ _____</td> </tr> <tr> <td>Custom</td> <td></td> <td>lgth</td> <td>\$ _____</td> </tr> </tbody> </table>				Finish:	Item code:	Unit:	Price:	Surfmist	10104450	lgth	\$ _____	Custom		lgth	\$ _____				
Finish:	Item code:	Unit:	Price:																			
Surfmist	10104450	lgth	\$ _____																			
Custom		lgth	\$ _____																			

1 ALUMINIUM

1.4 DOOR SECTIONS CONTINUED

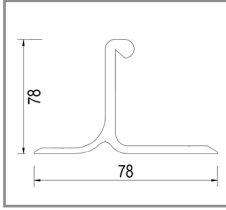
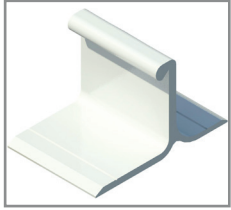

1.4.5

Description:

J Track
at 6500mm lengths

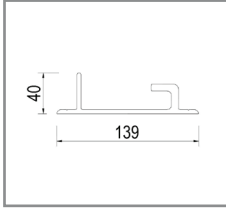
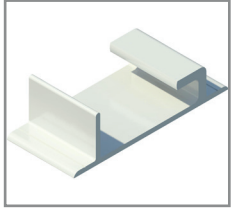

Industrial Door Track
at 6500mm lengths

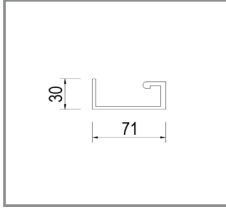
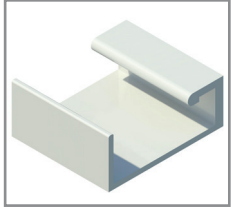

Commercial Door Track
at 6500mm lengths

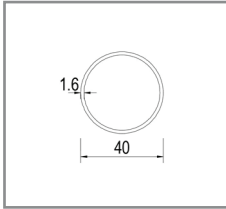
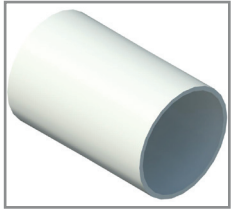

1.4.6

Description:

12x1.6 Tube
at 6500mm lengths

16x1.6 Tube
at 6500mm lengths

25x1.6 Tube
at 6500mm lengths

40x1.6 Tube
at 6500mm lengths

TRACKS

Finish:	Item code:	Unit:	Price:
Surfmist	10104500	Igth	\$ _____
Mill	10104501	Igth	\$ _____
Custom		Igth	\$ _____

Surfmist	10104600	Igth	\$ _____
Mill	10104601	Igth	\$ _____
Custom		Igth	\$ _____

Surfmist	10104550	Igth	\$ _____
Mill	10104551	Igth	\$ _____
Custom		Igth	\$ _____

TUBES

Finish:	Item code:	Unit:	Price:
Surfmist	10104650	Igth	\$ _____
Mill	10104651	Igth	\$ _____
Anodised	10104652	Igth	\$ _____
Custom		Igth	\$ _____

Surfmist	10104700	Igth	\$ _____
Mill	10104701	Igth	\$ _____
Anodised	10104702	Igth	\$ _____
Custom		Igth	\$ _____

Surfmist	10104750	Igth	\$ _____
Mill	10104751	Igth	\$ _____
Anodised	10104752	Igth	\$ _____
Custom		Igth	\$ _____

Surfmist	10104800	Igth	\$ _____
Mill	10104801	Igth	\$ _____
Anodised	10104802	Igth	\$ _____
Custom		Igth	\$ _____

		1.5.1	JOINER MOULDS			
		Description:	Finish:	Item code:	Unit:	Price:
		50x50x1.6mm Panel Joiner Mould at 6500mm lengths with V groove	Surfmist Mill Custom	10104850 10104851	lgth lgth lgth	\$ _____ \$ _____ \$ _____
		75x50x1.6mm Panel Joiner Mould at 6500mm lengths with V groove	Surfmist Mill Custom	10104900 10104901	lgth lgth lgth	\$ _____ \$ _____ \$ _____
		100x50x1.6mm Panel Joiner Mould at 6500mm lengths with V groove	Surfmist Mill Custom	10104950 10104951	lgth lgth lgth	\$ _____ \$ _____ \$ _____
		35x28x10mm Joiner Mould at 6500mm lengths	Mill Custom	10105001	lgth lgth	\$ _____ \$ _____
		70x40x25mm Joiner Mould at 6500mm lengths with V groove	Surfmist Custom	10105050	lgth lgth	\$ _____ \$ _____
		1.5.2	LEEROY			
		Description:	Finish:	Item code:	Unit:	Price:
		100x1.5 - 2.0mm Leeroy Flat Joiner at 4000mm lengths	Surfmist Custom	10105100	lgth lgth	\$ _____ \$ _____
		1.5.3	T-SECTIONS			
		Description:	Finish:	Item code:	Unit:	Price:
		40x20x1.6mm T Section Joiner at 6500mm lengths	Surfmist Mill Custom	10105150 10105151	lgth lgth lgth	\$ _____ \$ _____ \$ _____
		40x40x1.5mm T Section Joiner at 6500mm lengths	Surfmist Mill Custom	10105200 10105201	lgth lgth lgth	\$ _____ \$ _____ \$ _____

1 ALUMINIUM

1.6 FLAT BAR

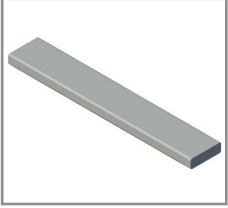
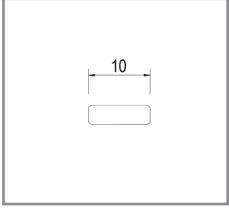
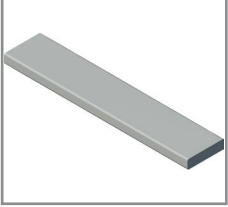
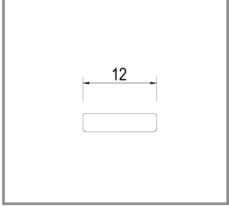
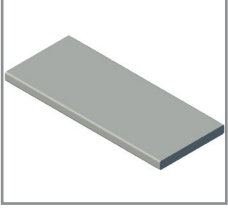
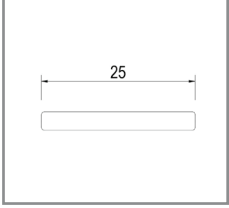
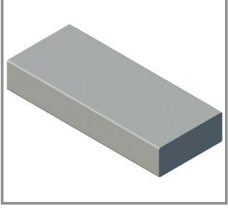
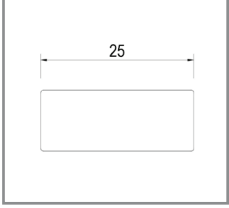
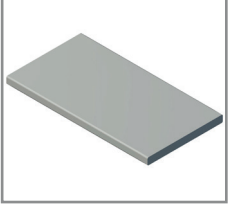
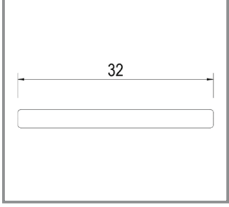
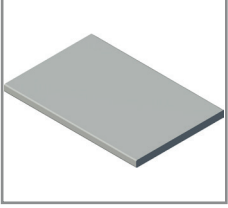
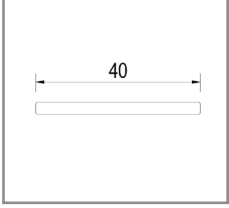
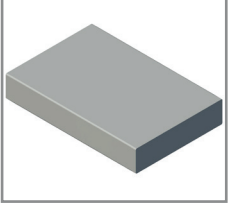
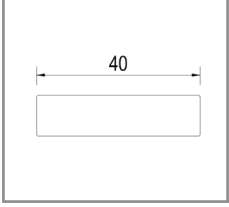
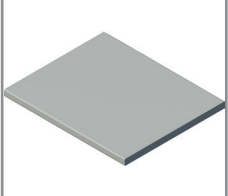
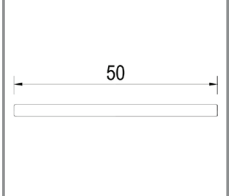
		Description:	Finish:	Item code:	Unit:	Price:
		10x3mm Aluminium Flat Bar at 4000mm lengths	Mill Custom	10105250	lgth lgth	\$ _____ \$ _____
		12x3mm Aluminium Flat Bar at 4000mm lengths	Mill Custom	10105300	lgth lgth	\$ _____ \$ _____
		25x3mm Aluminium Flat Bar at 4000mm lengths	Mill Custom	10105350	lgth lgth	\$ _____ \$ _____
		25x10mm Aluminium Flat Bar at 4000mm lengths	Mill Custom	10105400	lgth lgth	\$ _____ \$ _____
		32x3mm Aluminium Flat Bar at 4000mm lengths	Mill Custom	10105450	lgth lgth	\$ _____ \$ _____
		40x3mm Aluminium Flat Bar at 4000mm lengths	Mill Custom	10105500	lgth lgth	\$ _____ \$ _____
		40x10mm Aluminium Flat Bar at 4000mm lengths	Mill Custom	10105550	lgth lgth	\$ _____ \$ _____
		50x3mm Aluminium Flat Bar at 4000mm lengths	Mill Custom	10105600	lgth lgth	\$ _____ \$ _____

1 ALUMINIUM

1.6 FLAT BAR CONTINUED

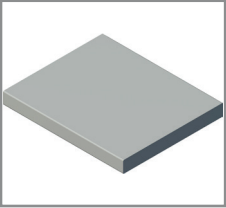
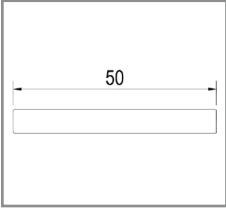
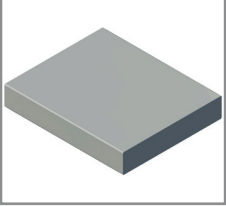
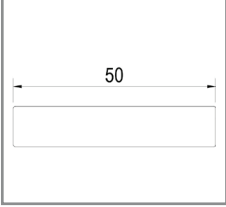
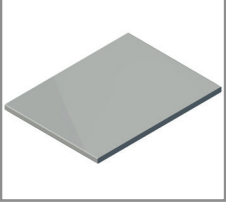
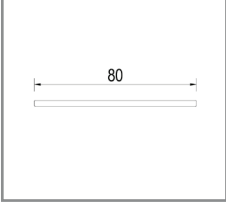
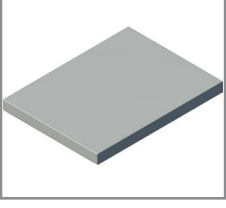
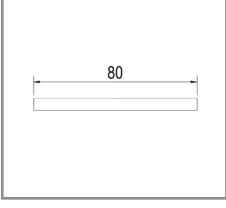
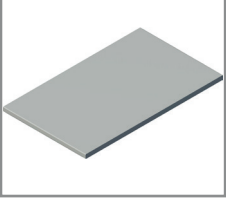
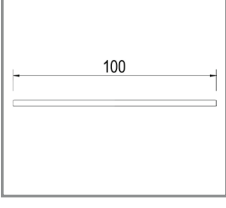
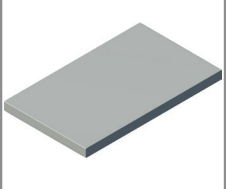
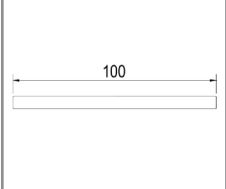
		Description:	Finish:	Item code:	Unit:	Price:
		50x6mm Aluminium Flat Bar at 4000mm lengths	Mill Custom	10105650	lgth lgth	\$ _____ \$ _____
		50x10mm Aluminium Flat Bar at 4000mm lengths	Mill Custom	10105700	lgth lgth	\$ _____ \$ _____
		80x3mm Aluminium Flat Bar at 4000mm lengths	Mill Custom	10105750	lgth lgth	\$ _____ \$ _____
		80x6mm Aluminium Flat Bar at 4000mm lengths	Mill Custom	10105800	lgth lgth	\$ _____ \$ _____
		100x3mm Aluminium Flat Bar at 4000mm lengths	Mill Custom	10105900	lgth lgth	\$ _____ \$ _____
		100x6mm Aluminium Flat Bar at 4000mm lengths	Mill Custom	10105950	lgth lgth	\$ _____ \$ _____

1 ALUMINIUM

1.7 BOX SECTIONS

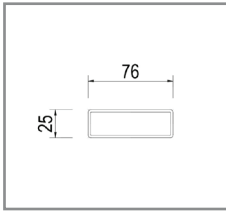
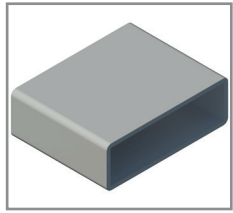

1.7.1

Description:
76x25x2.4mm
at 6500mm lengths

RHS

Finish:	Item code:	Unit:	Price:
Mill	10106001	lgth	\$ _____
Custom		lgth	\$ _____

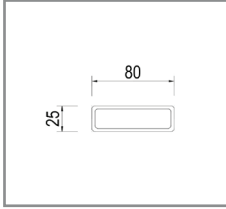
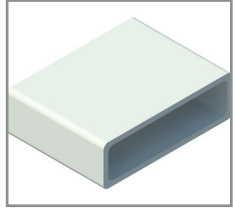

80x25x3mm
at 6500mm lengths

Surfmist	10106050	lgth	\$ _____
Mill	10106051	lgth	\$ _____
Custom		lgth	\$ _____

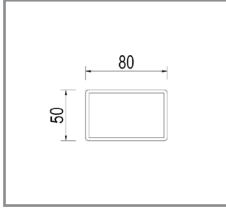

80x50x3mm
at 6500mm lengths

Surfmist	10106100	lgth	\$ _____
Mill	10106101	lgth	\$ _____
Custom		lgth	\$ _____

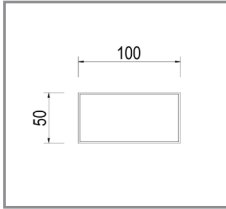
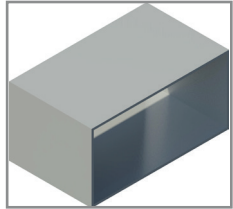

100x50x1.6mm
at 6500mm lengths

Mill	10106151	lgth	\$ _____
Custom		lgth	\$ _____

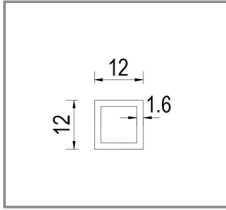
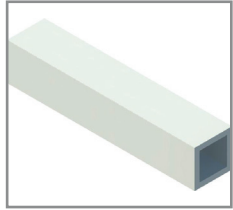

1.7.2

Description:
12x12x1.6mm
at 6500mm lengths

SHS

Finish:	Item code:	Unit:	Price:
Surfmist	10106200	lgth	\$ _____
Mill	10106201	lgth	\$ _____
Custom		lgth	\$ _____

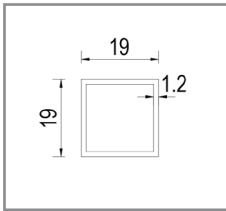
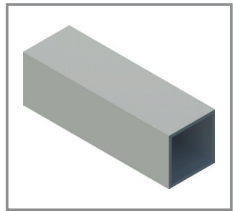

19x19x1.2mm
at 6500mm lengths

Mill	10106251	lgth	\$ _____
Custom		lgth	\$ _____

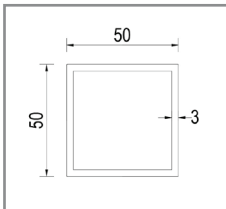
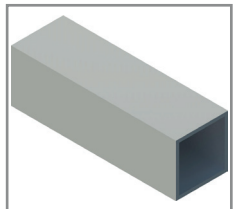

50x50x3mm
at 6500mm lengths

Mill	10106301	lgth	\$ _____
Custom		lgth	\$ _____

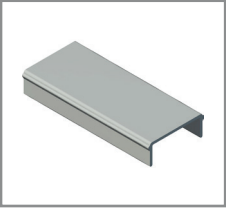
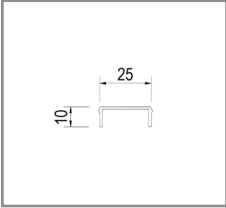
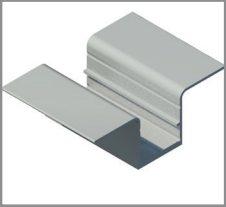
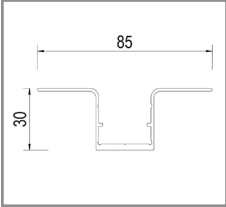
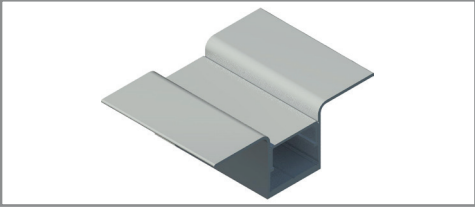
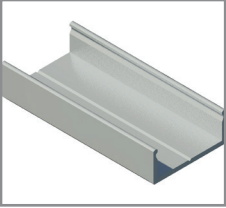
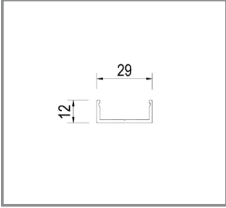
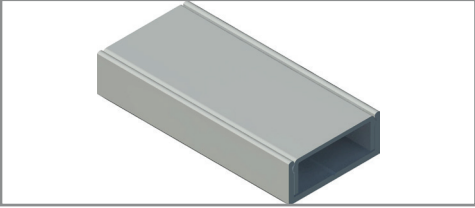
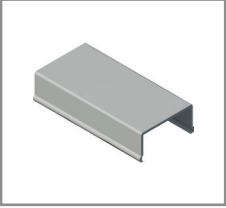
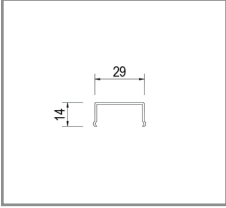
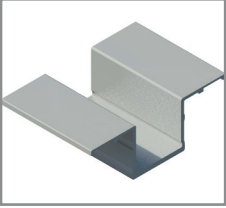
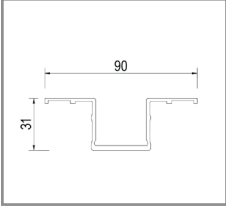
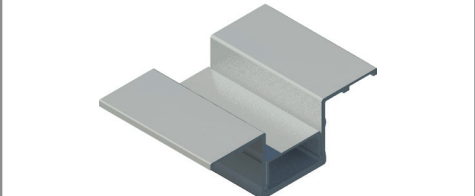

1 ALUMINIUM

1.8 TOP HATS

		Description:	Finish:	Item code:	Unit:	Price:
		AUSTFIL at 6500mm lengths	Mill Custom	10106350	lgth lgth	\$ _____ \$ _____
		AUSTFIX at 6500mm lengths	Mill Custom	10106400	lgth lgth	\$ _____ \$ _____
		AUSTFIL & AUSTFIX				
		AUSTBAT at 6500mm lengths	Mill Custom	10106450	lgth lgth	\$ _____ \$ _____
		AUSTFIL & AUSTBAT				
		ASKINFIL at 6500mm lengths	Mill Custom	10106500	lgth lgth	\$ _____ \$ _____
		ASKINFIX at 6500mm lengths	Mill Custom	10106550	lgth lgth	\$ _____ \$ _____
		ASKINFIL & ASKINFIX				

1 ALUMINIUM

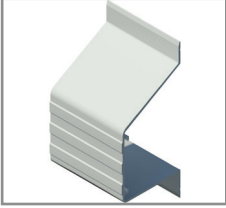
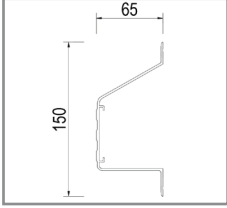
1.9 BUMP RAILS

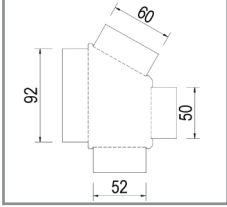
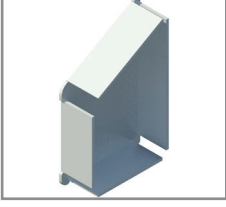
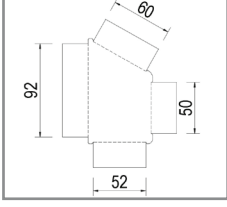
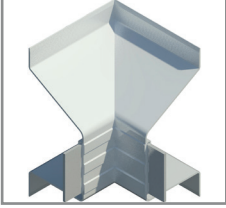
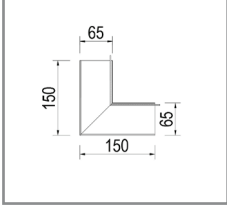
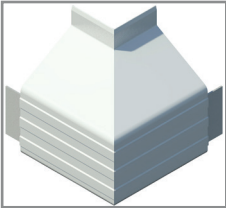
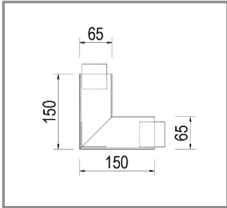
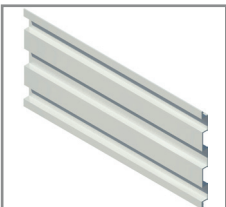
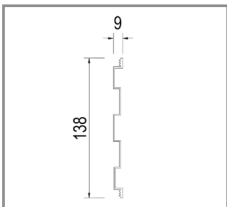
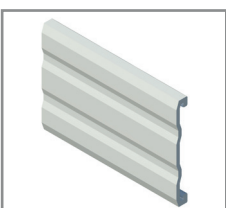
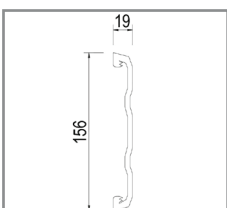
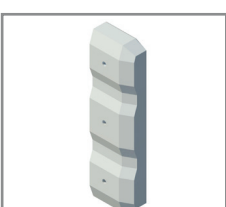
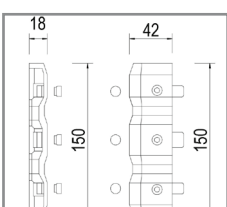
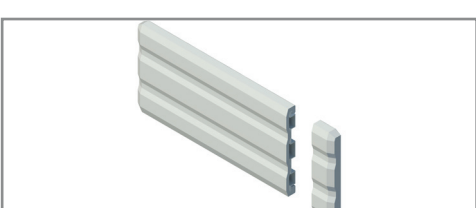
		Description:	Finish:	Item code:	Unit:	Price:
		BUMPRAIL1 - Rail Section at 6500mm lengths	Anodised	10106600	lgth	\$ _____
		BUMPRAIL1 - End Section Left	Anodised	10106601	ea	\$ _____
		BUMPRAIL1 - End Section Right	Anodised	10106602	ea	\$ _____
		BUMPRAIL1 - Internal Corner	Anodised	10106603	ea	\$ _____
		BUMPRAIL1 - External Corner	Anodised	10106604	ea	\$ _____
		BUMPRAIL2 - Rail Section Aluminum Wall Bracket	Mil	10106610	lgth	\$ _____
		BUMPRAIL2 - PVC Cover PVC Bump Rail	PVC Grey	10106611	lgth	\$ _____
		BUMPRAIL2 - End Section	PVC Grey	10106612	ea	\$ _____
		BUMPRAIL2 - Rail, PVC Cover & End Sections				

1 ALUMINIUM

1.9 BUMP RAILS CONTINUED

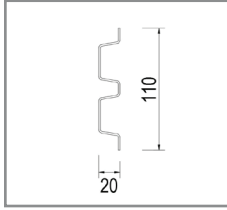
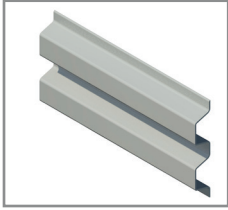

Description:
BUMPRAIL3 - Rail Section
at 6500mm lengths

Finish:	Item code:	Unit:	Price:
Mill	10106620	lgth	\$ _____

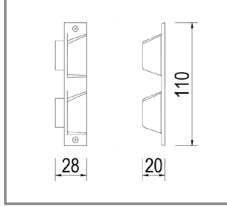
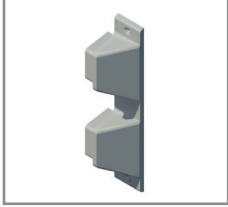

BUMPRAIL3 - End Section

Mill	10106621	ea	\$ _____
------	----------	----	----------

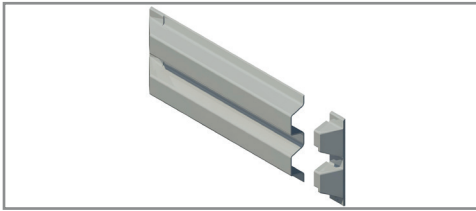

BUMPRAIL3 - Rail & End Sections

2 STEEL

2.1 STEEL SECTIONS

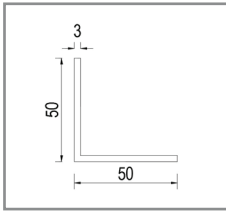
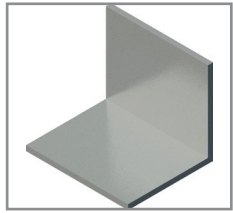

2.1.1

Description:

50x50x3mm Steel Angle
at 6500mm lengths

100x100x6mm Steel Angle
at 6500mm lengths

150x100x6mm Steel Angle
at 6500mm lengths

ANGLES

Finish:	Item code:	Unit:	Price:
Duragal	10110000	lgth	\$ _____
Duragal	10110001	lgth	\$ _____
Duragal	10110002	lgth	\$ _____

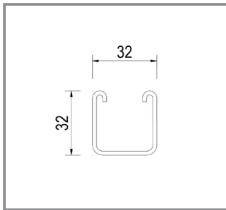
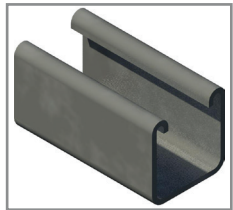

2.1.2

Description:

32x32x2.0mm Unistrut
at 6500mm lengths

CHANNELS

Finish:	Item code:	Unit:	Price:
Galv.	10110010	lgth	\$ _____

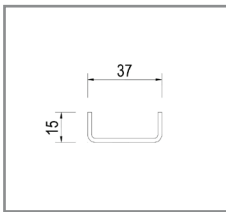
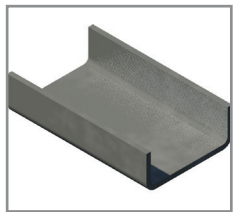

2.1.2

CHANNELS - CONCEALED FIXING

37x15x2.0mm Steel Channel
at 400mm lengths

37x15x2.0mm Steel Channel
at 600mm lengths

Galv.	10110020	lgth	\$ _____
Galv.	10110021	lgth	\$ _____

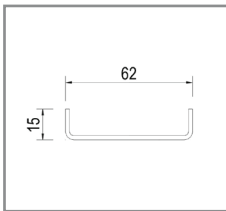
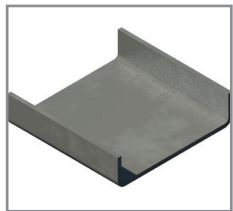

62x15x2.0mm Steel Channel
at 400mm lengths

62x15x2.0mm Steel Channel
at 600mm lengths

Galv.	10110022	lgth	\$ _____
Galv.	10110023	lgth	\$ _____

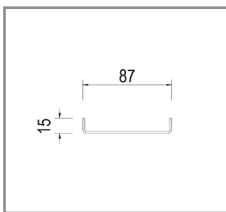
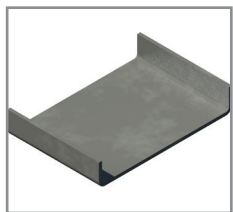

87x15x2.0mm Steel Channel
at 400mm lengths

87x15x2.0mm Steel Channel
at 600mm lengths

Galv.	10110024	lgth	\$ _____
Galv.	10110025	lgth	\$ _____

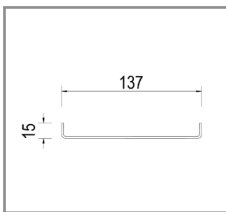
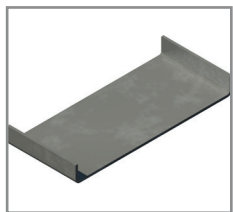

137x15x2.0mm Steel Channel
at 400mm lengths

137x15x2.0mm Steel Channel
at 600mm lengths

Galv.	10110026	lgth	\$ _____
Galv.	10110027	lgth	\$ _____

2.1.2

Description:

ROOF FIX 900
at 900mm lengths

CHANNELS - UNIDECK

Finish:	Item code:	Unit:	Price:
Galv.	10110050	lgth	\$ _____

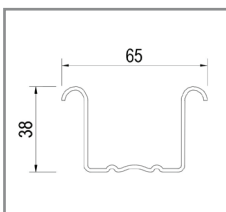
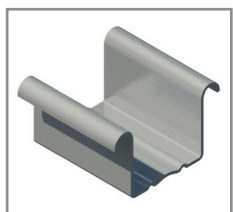

Snap on Capping
at lengths TBC

Hamlet	10110051	mt	\$ _____
Off White	10110052	mt	\$ _____
Custom		mt	\$ _____

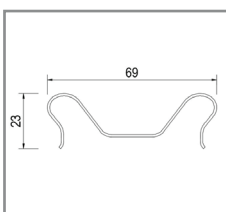
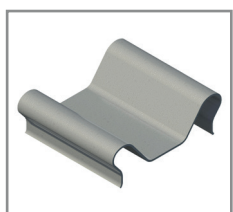





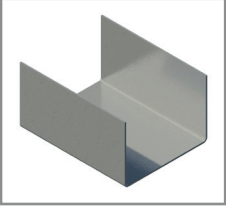
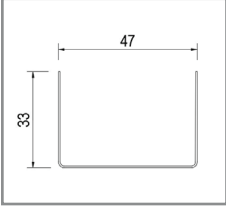
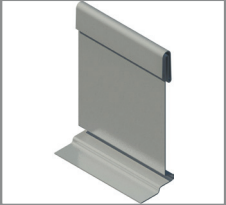
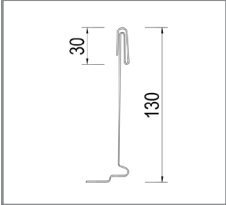
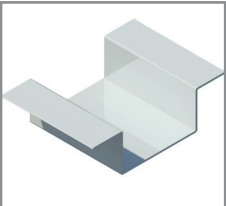
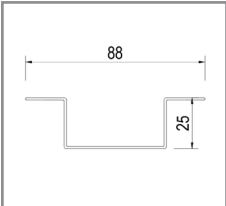
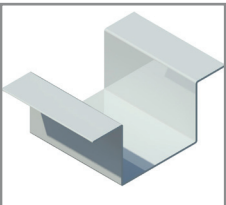
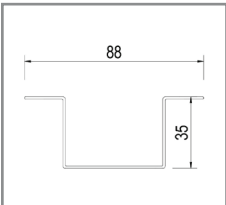
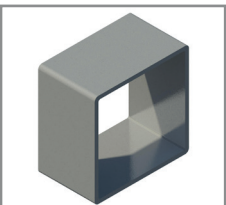
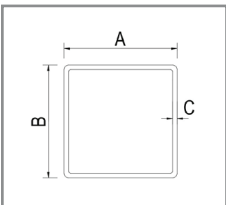
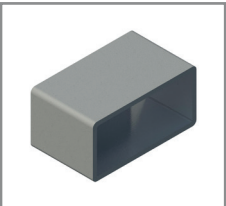
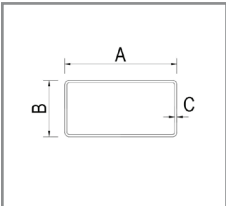

2 STEEL

2.1 STEEL SECTIONS CONTINUED

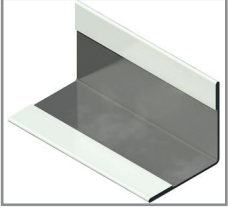
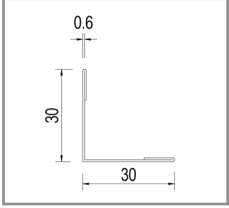
		2.1.2 Description: 400/600 Profile Section at lengths TBC	CHANNELS - UNIDECK Finish: Colour to match roof	Item code: 10110060	Unit: lgth	Price: \$ _____
		2.1.3 Description: 105mm for 75mm Econodeck Roof 130mm for 100mm Econodeck Roof 155mm for 125mm Econodeck Roof 180mm for 150mm Econodeck Roof 230mm for 200mm Econodeck Roof	CLIPS - ECONODECK Finish: Glav.	Item code: 10110070 10110071 10110072 10110073 10110074	Unit: ea ea ea ea ea	Price: \$ _____ \$ _____ \$ _____ \$ _____ \$ _____
		2.1.4 Description: 50x25x20x1.15mm Top Hat at 6000mm lengths	TOP HAT BATTENS Finish: Zinc Plated	Item code: 10110080	Unit: lgth	Price: \$ _____
		50x35x20x1.15mm Top Hat at 6000mm lengths	Zinc Plated	10110081	lgth	\$ _____
		2.1.5 Description: (AxBxC) Length:6500mm 50x50x1.6mm SHS 50x50x2.5mm SHS 50x50x3.0mm SHS 50x50x5.0mm SHS 75x75x3.0mm SHS 100x100x4.0mm SHS	SHS Finish: Duragal	Item code: 10110090 10110091 10110092 10110093 10110094 10110095	Unit: lgth lgth lgth lgth lgth lgth	Price: \$ _____ \$ _____ \$ _____ \$ _____ \$ _____ \$ _____
		2.1.6 Description: (AxBxC) Length:6500mm 100x50x2.0mm RHS 100x50x3.0mm RHS 100x50x4.0mm RHS 125x75x3.0mm RHS 125x75x4.0mm RHS 150x50x2.0mm RHS 150x50x3.0mm RHS	RHS Finish: Duragal	Item code: 10110100 10110101 10110102 10110103 10110104 10110105 10110106	Unit: lgth lgth lgth lgth lgth lgth lgth	Price: \$ _____ \$ _____ \$ _____ \$ _____ \$ _____ \$ _____ \$ _____

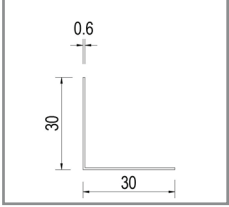
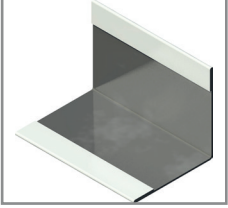
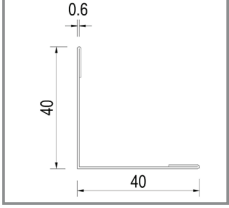
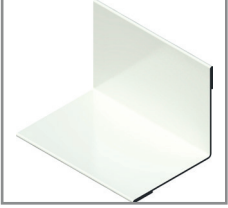
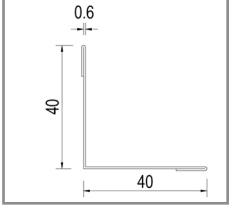
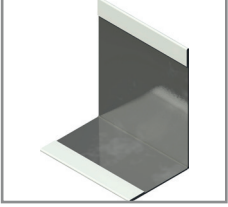
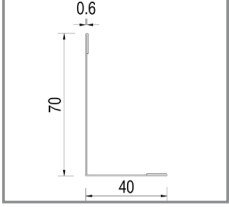
2 STEEL

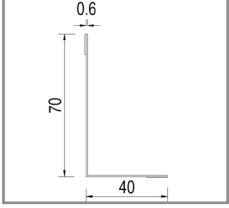
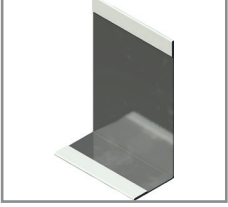
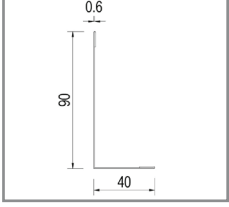
2.2 FLASHINGS

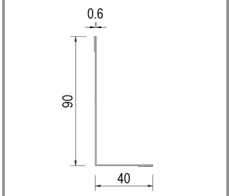
		2.2.1	ANGLES			
		Description:	Finish:	Item code:	Unit:	Price:
		30x30x0.6mm External CB Angle at 6000mm lengths with safety edge	Surfmist Custom	10111000	ea	\$ _____ \$ _____
		30x30x0.6mm Internal CB Angle at 6000mm lengths	Surfmist Custom	10111050	ea	\$ _____ \$ _____
		40x40x0.6mm External CB Angle at 6000mm lengths with safety edge	Surfmist Custom	10111100	ea	\$ _____ \$ _____
		40x40x0.6mm Internal CB Angle at 6000mm lengths with safety edge	Surfmist Custom	10111150	ea	\$ _____ \$ _____
		70x40x0.6mm External CB Angle at 6000mm lengths with safety edge	Surfmist Custom	10111200	ea	\$ _____ \$ _____
		70x40x0.6mm Internal CB Angle at 6000mm lengths with safety edge	Surfmist Custom	10111250	ea	\$ _____ \$ _____
		90x40x0.6mm External CB Angle at 6000mm lengths with safety edge	Surfmist Custom	10111300	ea	\$ _____ \$ _____
		90x40x0.6mm Internal CB Angle at 6000mm lengths with safety edge	Surfmist Custom	10111350	ea	\$ _____ \$ _____

2.2.2			CHANNELS			
Description:			Finish:	Item code:	Unit:	Price:
		54x40x0.6mm CB Channel at 6000mm lengths with safety edge	Surfmist	10111400	ea	\$ _____
			Custom		ea	\$ _____
		79x40x0.6mm CB Channel at 6000mm lengths with safety edge	Surfmist	10111450	ea	\$ _____
			Custom		ea	\$ _____
		104x40x0.6mm CB Channel at 6000mm lengths with safety edge	Surfmist	10111500	ea	\$ _____
			Custom		ea	\$ _____
		129x40x0.6mm CB Channel at 6000mm lengths with safety edge	Surfmist	10111550	ea	\$ _____
			Custom		ea	\$ _____
		154x40x0.6mm CB Channel at 6000mm lengths with safety edge	Surfmist	10111600	ea	\$ _____
			Custom		ea	\$ _____
		204x40x0.6mm CB Channel at 6000mm lengths with safety edge	Surfmist	10111650	ea	\$ _____
			Custom		ea	\$ _____
2.2.3			COVING			
Description:			Finish:	Item code:	Unit:	Price:
		40x40x0.6mm Coving at 6000mm lengths with safety edge	Surfmist	10111700	ea	\$ _____
			Custom		ea	\$ _____
		35x35x0.6mm Coving at 6000mm lengths with safety edge	Surfmist	10111750	ea	\$ _____
			Custom		ea	\$ _____

2 STEEL

2.2 FLASHINGS CONTINUED

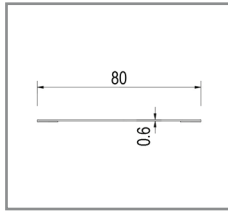
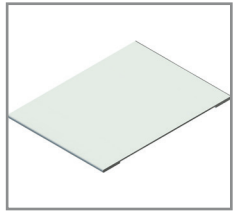

2.2.4

Description:

80x0.6mm Flat
at 4000mm lengths
with safety edge

FLAT

Finish:	Item code:	Unit:	Price:
Surfmist	1011800	ea	\$ _____
Custom		ea	\$ _____

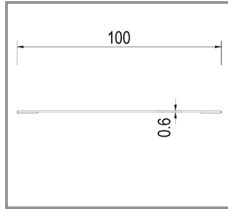
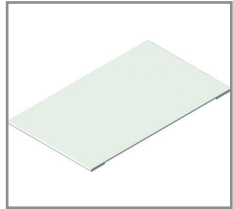

100x0.6mm Flat
at 4000mm lengths
with safety edge

Surfmist	1011850	ea	\$ _____
Custom		ea	\$ _____

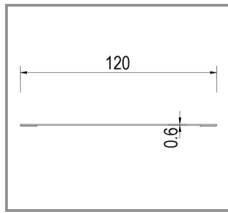
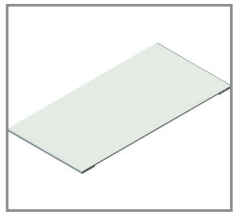

120x0.6mm Flat
at 4000mm lengths
with safety edge

Surfmist	1011900	ea	\$ _____
Custom		ea	\$ _____

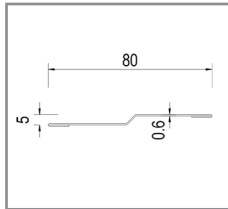
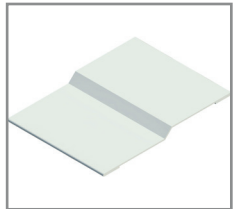

80x0.6mm Weather Guard
at 4000mm lengths
with bend & safety edge

Surfmist	1011950	ea	\$ _____
Custom		ea	\$ _____

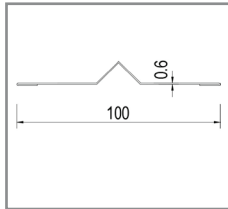
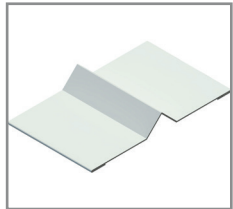

100x0.6mm V Crimp
at 4000mm lengths
with V fold & safety edge

Surfmist	10112000	ea	\$ _____
Custom		ea	\$ _____

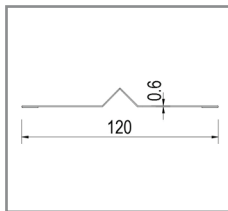
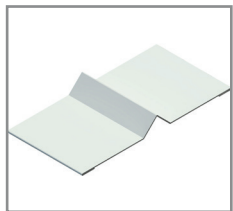

120x0.6mm V Crimp
at 4000mm lengths
with V fold & safety edge

Surfmist	10112050	ea	\$ _____
Custom		ea	\$ _____

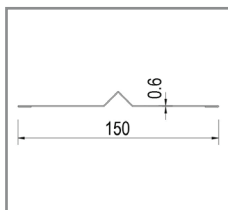
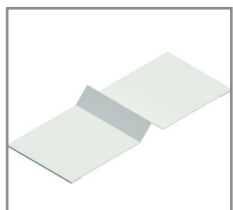

150x0.6mm V Crimp
at 4000mm lengths
with V fold & safety edge

Surfmist	10112100	ea	\$ _____
Custom		ea	\$ _____

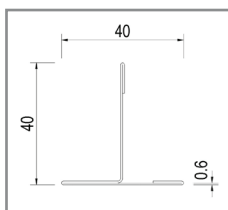
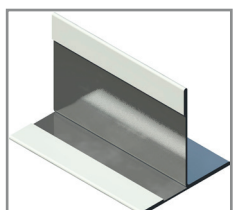

2.2.5

Description:



40X40x0.6mm CB T Section
at 6000mm lengths
with safety edge

T-SECTIONS

Finish:	Item code:	Unit:	Price:
Surfmist	10112150	ea	\$ _____
Custom		ea	\$ _____

2 STEEL

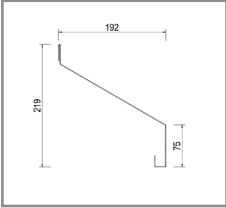
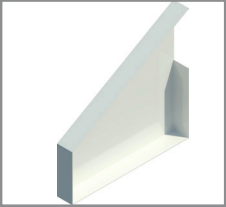
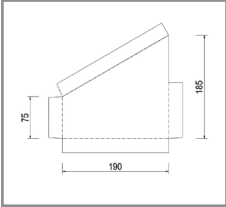
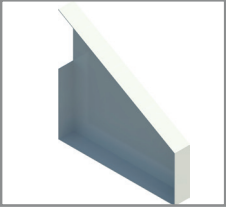
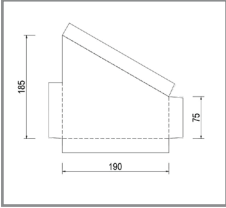
2.4 PELMETS

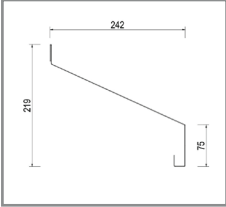
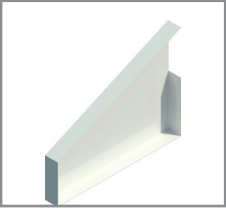
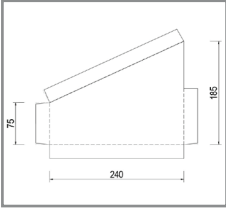
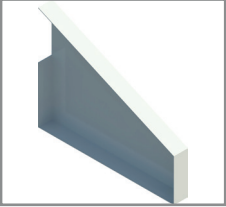
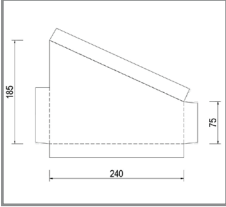
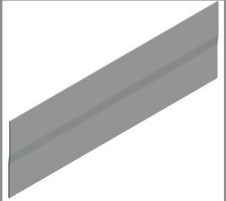
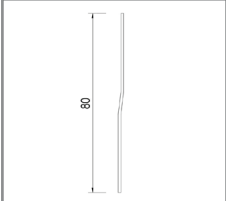
		Description:	Finish:	Item code:	Unit:	Price:
		Pelmet100 - Profile Section length made to order	Surfmist S/Steel Custom	10112300 1012301	mt mt mt	\$ _____ \$ _____ \$ _____
		Pelmet100 - End Cap Left	Surfmist S/Steel Custom	10112350 10112351	mt mt mt	\$ _____ \$ _____ \$ _____
		Pelmet100 - End Cap Right	Surfmist S/Steel Custom	10112400 10112401	mt mt mt	\$ _____ \$ _____ \$ _____
		Pelmet150 - Profile Section length made to order	Surfmist S/Steel Custom	10112450 10112451	mt mt mt	\$ _____ \$ _____ \$ _____
		Pelmet150 - End Cap Left	Surfmist S/Steel Custom	10112500 10112501	mt mt mt	\$ _____ \$ _____ \$ _____
		Pelmet150 - End Cap Right	Surfmist S/Steel Custom	10112550 10112551	mt mt mt	\$ _____ \$ _____ \$ _____
		Pelmet Bracket length made to order	Galv. S/Steel	10112600 10112601	mt mt	\$ _____ \$ _____

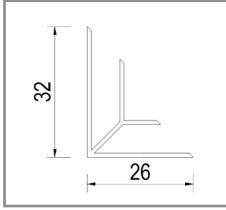
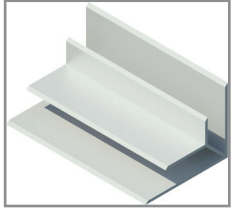

3.1

Description:
32x26x1mm Corner Angle
at 6500mm lengths

ANGLES

Finish:	Item code:	Unit:	Price:
White	10120000	ea	\$ _____

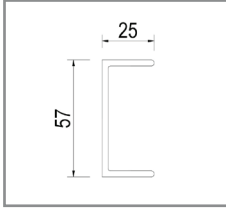
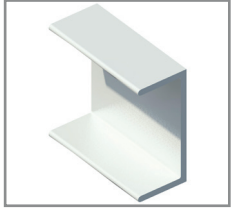

3.2

Description:
57x25x3mm (51mm Int.)
at 3000mm lengths
at 4250mm lengths

CHANNELS

Finish:	Item code:	Unit:	Price:
White	10120110	ea	\$ _____
White	10120120	ea	\$ _____

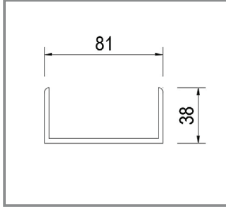
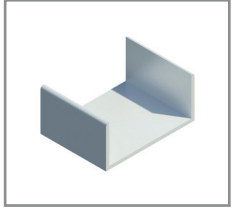

81x38x3mm (75mm Int.)
at 4250mm lengths

White	10120121	ea	\$ _____
-------	----------	----	----------

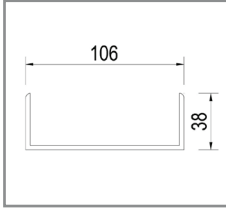
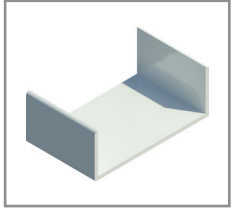

106x38x3mm (100mm Int.)
at 4250mm lengths

White	10120122	ea	\$ _____
-------	----------	----	----------

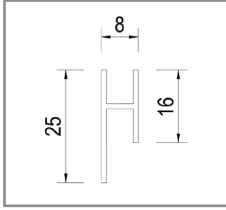
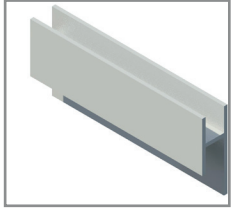

3.3

Description:
25x8x1.1mm Strip Joiner
at 6500mm lengths

JOINERS

Finish:	Item code:	Unit:	Price:
White	10120130	ea	\$ _____

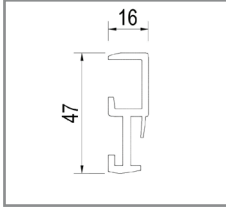
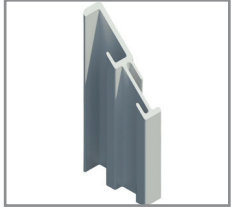

3.4

Description:
SA3 Packer

PACKERS

Finish:	Item code:	Unit:	Price:
Grey	10120140	ea	\$ _____
Black	10120141	ea	\$ _____

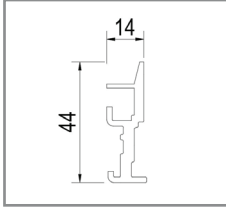
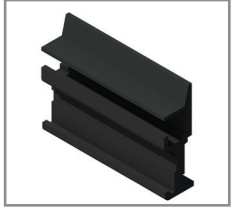

50mm Modified Packer

Black	10120142	ea	\$ _____
-------	----------	----	----------

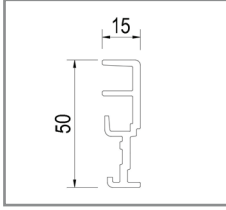

50mm Packer

Black	10120143	ea	\$ _____
-------	----------	----	----------

		3.4	PACKERS			
		Description:	Finish:	Item code:	Unit:	Price:
		65mm Packer #1	Black	10120144	ea	\$ _____
		65mm Packer #2	Black	10120145	ea	\$ _____
		PVC Flat Bar	White	10120146	ea	\$ _____
		3.5	STRIPS			
		Description:	Finish:	Item code:	Unit:	Price:
		20x12x3mm PVC Hinge Strip	White	10120160	ea	\$ _____
		25x15x3mm PVC Hinge Strip	White	10120161	ea	\$ _____
		75x2400x3mm PVC Frame Strip	White	10120180	lgth	\$ _____
		100x2400x3mm PVC Frame Strip	White	10120181	lgth	\$ _____
		150x2400x3mm PVC Frame Strip	White	10120183	lgth	\$ _____
		200x2400x3mm PVC Frame Strip	White	10120185	lgth	\$ _____
		250x2400x3mm PVC Frame Strip	White	10120187	lgth	\$ _____
		300x2400x3mm PVC Frame Strip	White	10120189	lgth	\$ _____
		3.6	TUBES			
		Description:	Finish:	Item code:	Unit:	Price:
		16mm Conduit Sleeve at 4000mm lengths	White	10120200	ea	\$ _____
		PVC Ferrule 48mm long	White	10120201	ea	\$ _____
		PVC Ferrule 73mm long	White	10120202	ea	\$ _____
		PVC Ferrule 98mm long	White	10120203	ea	\$ _____
		PVC Ferrule 148mm long	White	10120205	ea	\$ _____
		PVC Ferrule 198mm long	White	10120207	ea	\$ _____
		PVC Ferrule 248mm long	White	10120209	ea	\$ _____

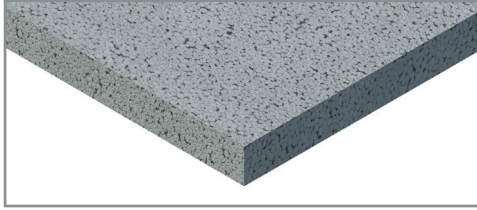

4.1

XFLAM

Item code:

Description:

Unit: Price:

- 30x1200x2920mm
- 50x1200x2920mm
- 75x1200x2920mm
- 100x1200x2920mm
- 125x1200x2920mm
- 150x1200x2920mm
- 175x1200x2920mm
- 200x1200x2920mm
- 250x1200x2920mm

- p/m² \$ _____
- p/m² \$ _____
- p/m² \$ _____
- p/m² \$ _____
- p/m² \$ _____
- p/m² \$ _____
- p/m² \$ _____
- p/m² \$ _____
- p/m² \$ _____

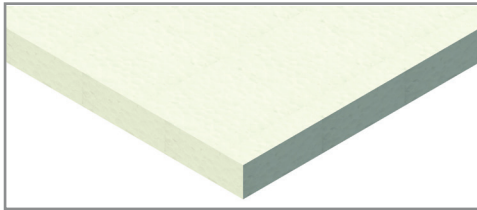

4.2

PIR

Item code:

Description:

Unit: Price:

- 25x1200x2400mm
- 50x1200x2400mm
- 75x1200x2400mm
- 100x1200x2400mm
- 150x1200x2400mm

- ea \$ _____
- ea \$ _____
- ea \$ _____
- ea \$ _____
- ea \$ _____

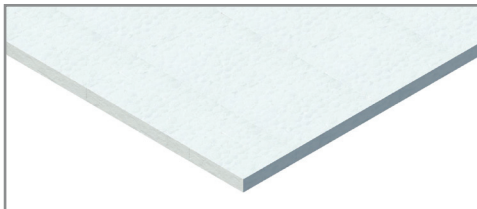

4.3

EPS - SL GRADE

Item code:

Description:

Unit: Price:

- 10x1200mm
- 20x1200mm
- 25x1200mm
- 30x1200mm
- 50x1200mm
- 75x1200mm
- 100x1200mm
- 125x1200mm
- 150x1200mm
- 175x1200mm
- 200x1200mm
- 250x1200mm
- 300x1200mm
- 400x1200mm
- 600x1200mm

- p/m² \$ _____
- p/m² \$ _____
- p/m² \$ _____
- p/m² \$ _____
- p/m² \$ _____
- p/m² \$ _____
- p/m² \$ _____
- p/m² \$ _____
- p/m² \$ _____
- p/m² \$ _____
- p/m² \$ _____
- p/m² \$ _____
- p/m² \$ _____
- p/m² \$ _____

Note: Check Sheet Sizes with your ASKIN rep. Custom sizes are available - POA

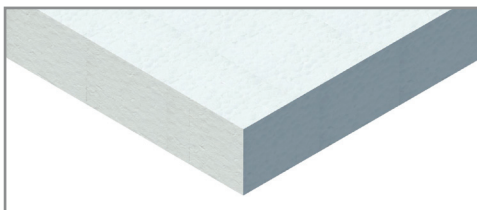

4.3

EPS - S GRADE

Item code:

Description:

Unit: Price:

- 50x1200mm
- 75x1200mm
- 100x1200mm
- 125x1200mm
- 150x1200mm
- 175x1200mm
- 200x1200mm
- 250x1200mm
- 300x1200mm
- 600x1200mm

- p/m² \$ _____
- p/m² \$ _____
- p/m² \$ _____
- p/m² \$ _____
- p/m² \$ _____
- p/m² \$ _____
- p/m² \$ _____
- p/m² \$ _____
- p/m² \$ _____
- p/m² \$ _____

Note: Check Sheet Sizes with your ASKIN rep. Custom sizes are available - POA

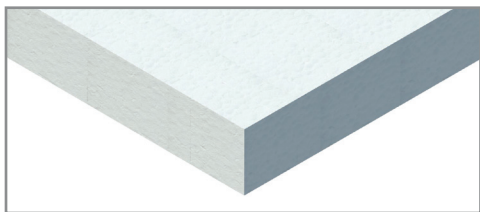

4.3

EPS - M GRADE

Item code:	Description:	Unit:	Price:
	50x1200mm	p/m ²	\$ _____
	75x1200mm	p/m ²	\$ _____
	100x1200mm	p/m ²	\$ _____
	125x1200mm	p/m ²	\$ _____
	150x1200mm	p/m ²	\$ _____
	175x1200mm	p/m ²	\$ _____
	200x1200mm	p/m ²	\$ _____
	250x1200mm	p/m ²	\$ _____
	300x1200mm	p/m ²	\$ _____
	600x1200mm	p/m ²	\$ _____

Note: Check Sheet Sizes with your ASKIN rep. Custom sizes are available - POA

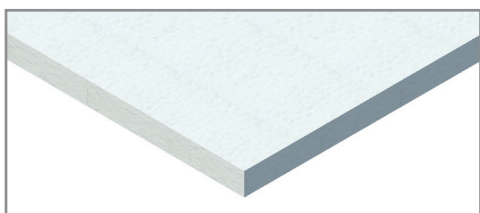

4.3

EPS - H GRADE

Item code:	Description:	Unit:	Price:
	20x1200mm	p/m ²	\$ _____
	30x1200mm	p/m ²	\$ _____
	50x1200mm	p/m ²	\$ _____
	75x1200mm	p/m ²	\$ _____
	80x1200mm	p/m ²	\$ _____
	100x1200mm	p/m ²	\$ _____
	125x1200mm	p/m ²	\$ _____
	150x1200mm	p/m ²	\$ _____
	175x1200mm	p/m ²	\$ _____
	200x1200mm	p/m ²	\$ _____
	250x1200mm	p/m ²	\$ _____
	300x1200mm	p/m ²	\$ _____
	600x1200mm	p/m ²	\$ _____

Note: Check Sheet Sizes with your ASKIN rep. Custom sizes are available - POA

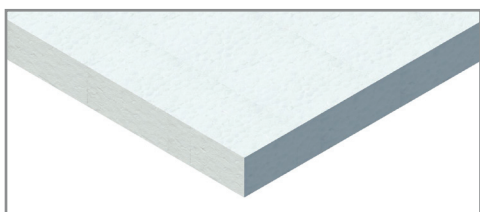

4.3

EPS - VH GRADE

Item code:	Description:	Unit:	Price:
	30x1200mm	p/m ²	\$ _____
	50x1200mm	p/m ²	\$ _____
	75x1200mm	p/m ²	\$ _____
	100x1200mm	p/m ²	\$ _____
	125x1200mm	p/m ²	\$ _____
	150x1200mm	p/m ²	\$ _____
	175x1200mm	p/m ²	\$ _____
	200x1200mm	p/m ²	\$ _____
	250x1200mm	p/m ²	\$ _____
	300x1200mm	p/m ²	\$ _____
	600x1200mm	p/m ²	\$ _____

Note: Check Sheet Sizes with your ASKIN rep. Custom sizes are available - POA

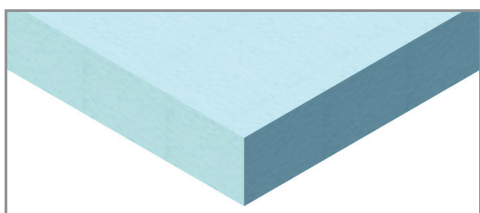

4.4

EXTRUDED POLYSTYRENE (XPS)

Item code:	Description:	Unit:	Price:
	50x600x2500mm	p/m ²	\$ _____
	75x600x2500mm	p/m ²	\$ _____
	100x600x2500mm	p/m ²	\$ _____
	150x600x2500mm	p/m ²	\$ _____

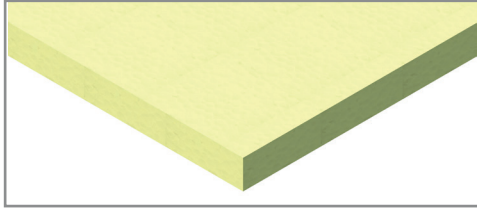

4.5

Item code:

10130000	25x1200x2400mm
10130001	50x1200x2400mm
10130002	75x1200x2400mm
10130003	100x1200x2400mm
10130004	150x1200x2400mm

PUR

Unit: Price:

ea	\$ _____
ea	\$ _____
ea	\$ _____
ea	\$ _____
ea	\$ _____

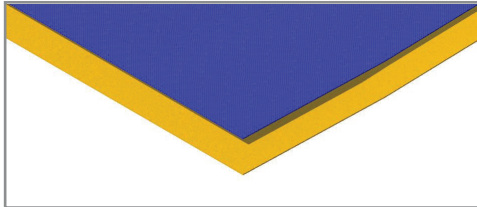

4.6

Item code:

10130100	(50mt)200UM Floor - 4000mm Width
10130101	(25mt)300UM Floor - 4000mm Width

POLYTHENE

Finish: Unit: Price:

Black	p/m ²	\$ _____
Orange	p/m ²	\$ _____

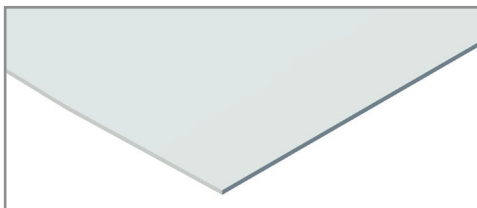

4.7

Item code:

10130110	3x1220x2440mm
10130111	6x1220x2440mm
10130112	6x1500x3000mm

PVC

Finish: Unit: Price:

White	ea	\$ _____
White	ea	\$ _____
Black	ea	\$ _____

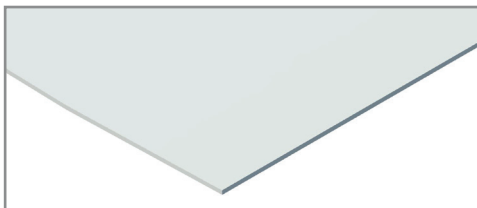

4.8

Item code:

10120190	1x1220x2440mm
10120191	3x1220x2440mm

FOREX

Finish: Unit: Price:

White	ea	\$ _____
White	ea	\$ _____

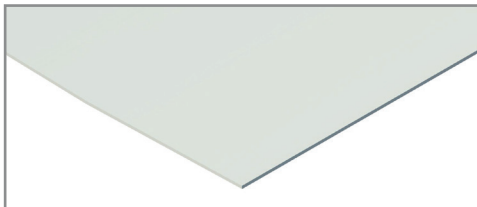

4.9

Description:

0.6x1260mm(W), Colourbond Steel, cut to length
Available in 22 Standard & 6 Premium Colours
Printech - Complete colour range on request

STEEL

Unit: Price:

p/m ²	\$ _____
------------------	----------

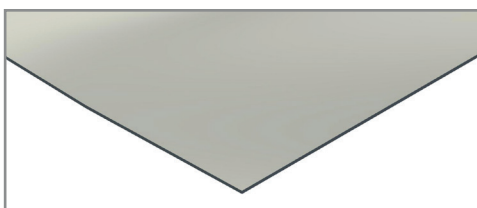

Item code:

Per Sheet:

10130120	0.75x1220x2440mm
10130121	1.15x1220x2440mm

Finish: Unit: Price:

Galv.	ea	\$ _____
Galv.	ea	\$ _____

Cut to size:

0.75x1220x2440mm
1.15x1220x2440mm

Galv.	p/m ²	\$ _____
Galv.	p/m ²	\$ _____

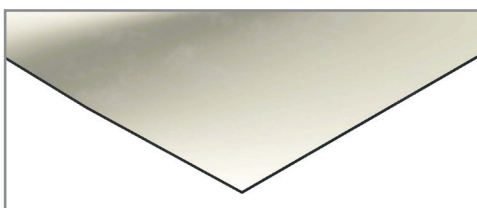

Per Sheet:

10130122	0.55x1200x2400mm
10130123	0.7x1200x2400mm
10130124	0.9x1200x2400mm
10130125	1.6x1200x2400mm

S/Steel	ea	\$ _____
S/Steel	ea	\$ _____
S/Steel	ea	\$ _____
S/Steel	ea	\$ _____

Cut to size:

0.55x1200x2400mm
0.7x1200x2400mm
0.9x1200x2400mm
1.6x1200x2400mm

S/Steel	p/m ²	\$ _____
S/Steel	p/m ²	\$ _____
S/Steel	p/m ²	\$ _____
S/Steel	p/m ²	\$ _____

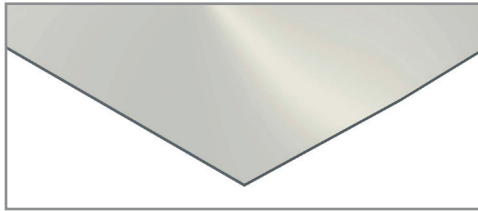

4.10

ALUMINIUM

Item code:	Description:	Finish:	Unit:	Price:
Per Sheet: 10130140	2400x1200x1.0mm Aluminium Sheet	Mill	ea	\$ _____
10130141	2400x1200x1.6mm Aluminium Sheet	Mill	ea	\$ _____
10130142	2400x1200x3.0mm Aluminium Sheet	Mill	ea	\$ _____
Cut to size:				
	2400x1200x1.0mm Aluminium Sheet	Mill	p/m ²	\$ _____
	2400x1200x1.6mm Aluminium Sheet	Mill	p/m ²	\$ _____
	2400x1200x3.0mm Aluminium Sheet	Mill	p/m ²	\$ _____

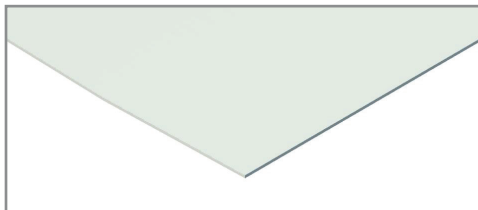

Per sheet:

10130143	2400x1200x1.0mm Aluminium Sheet	Surfmist	ea	\$ _____
10130144	2400x1200x1.6mm Aluminium Sheet	Surfmist	ea	\$ _____
10130145	2400x1200x3.0mm Aluminium Sheet	Surfmist	ea	\$ _____

Cut to size:

	2400x1200x1.0mm Aluminium Sheet	Surfmist	p/m ²	\$ _____
	2400x1200x1.6mm Aluminium Sheet	Surfmist	p/m ²	\$ _____
	2400x1200x3.0mm Aluminium Sheet	Surfmist	p/m ²	\$ _____

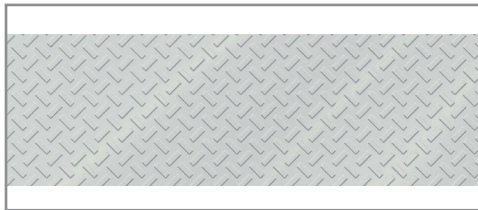

Per sheet:

10130160	2400x1200x1.6 Treadplate	Mill	ea	\$ _____
----------	--------------------------	------	----	----------

Cut to size:

	2400x1200x1.6 Treadplate	Mill	p/m ²	\$ _____
--	--------------------------	------	------------------	----------



Per sheet:

10130161	2400x1200x1.6 Treadplate	Surfmist	ea	\$ _____
----------	--------------------------	----------	----	----------

Cut to size:

	2400x1200x1.6 Treadplate	Surfmist	p/m ²	\$ _____
--	--------------------------	----------	------------------	----------

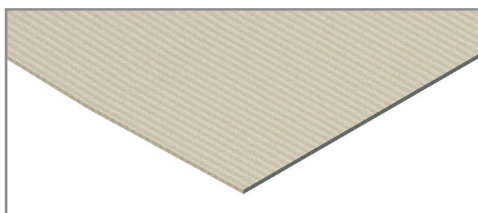

4.11

TIMBER - MDF

Item code:	Description:	Unit:	Price:
10130180	3x1000x2440mm	ea	\$ _____
10130181	3x1200x2400mm	ea	\$ _____
10130182	3x1220x1830mm	ea	\$ _____
10130183	4.75x1220x2440mm	ea	\$ _____



4.11

TIMBER - PLYWOOD

Item code:	Description:	Unit:	Price:
10130190	4x1200x2400mm	ea	\$ _____
10130191	9x1200x2400mm	ea	\$ _____
10130192	12x1200x2400mm	ea	\$ _____
10130193	16x1200x2400mm	ea	\$ _____
10130194	19x1200x2400mm	ea	\$ _____
10130195	25x1200x2400mm	ea	\$ _____

5 SUSPENSION COMPONENTS

5.1 COMPONENTS

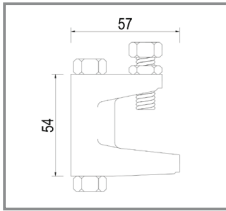
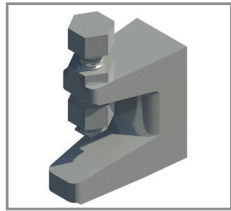

5.1.1

Item code:
10140000
10140001

Description:
M10 Beam Clamp
M12 Beam Clamp

BEAM CLAMPS

Finish: Galv.
Unit: ea
Price: \$ _____

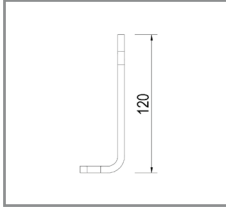

5.1.2

Item code:
10140010
10140011

Description:
120x40x6mm L Bracket
120x40x6mm L Bracket

BRACKETS

Finish: Galv.
Unit: ea
Price: \$ _____

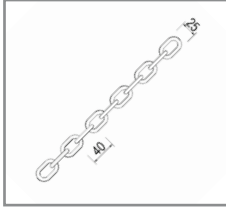

5.1.3

Item code:
10140020

Description:
6mmx60m - Certified SWL 320
Safety Factor 4-1

CHAINS

Finish: Galv.
Unit: ea
Price: \$ _____

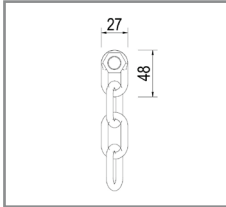

10140021

Chain & Nut Complete

Galv. ea \$ _____

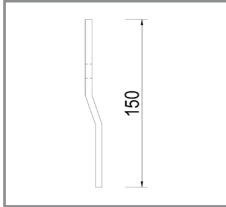
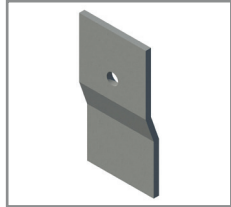

5.1.4

Item code:
10140030

Description:
M12 150x75x10mm Purlin Clip

CLIPS

Finish: Galv.
Unit: ea
Price: \$ _____

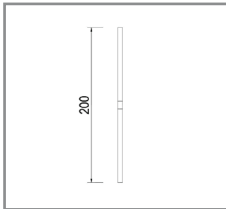
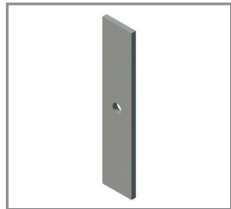

5.1.5

Item code:
10140031

Description:
200x40x6mm

PLATES

Finish: Galv.
Unit: ea
Price: \$ _____

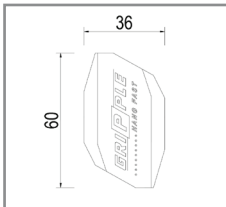

5.1.6

Item code:
10140040

Description:
Hangfast No.4 Gripple
SWL 225kg
5-1 Safety Factor

GRIPPLES

Finish: Galv.
Unit: ea
Price: \$ _____

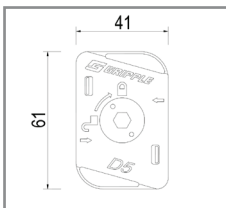
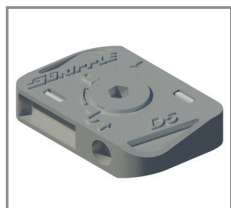

10140041

Hangfast No.5 6mm Lockable Gripple
SWL 500kg
5-1 Safety Factor

Galv. ea \$ _____

5 SUSPENSION COMPONENTS

5.1 COMPONENTS CONTINUED

		5.1.7	TURNBUCKLES		Finish:	Unit:	Price:
		Item code:	Description:				
		10140050	M10 c/w Eye Bolts	Galv.	ea	\$ _____	
		10140051	M12 c/w Eye Bolts	Galv.	ea	\$ _____	
		5.1.8	D-SHACKLES		Finish:	Unit:	Price:
		Item code:	Description:				
		10140060	60mm D Shackle	Galv.	ea	\$ _____	
		5.1.9	CABLE CLAMP		Finish:	Unit:	Price:
		Item code:	Description:				
		10140061	38mm Cable Clamp	Galv.	ea	\$ _____	
		5.1.10	MUSHROOM HEADS		Finish:	Unit:	Price:
		Item code:	Description:				
		10140100	M10 - Nut only, no washer	Surfmist	ea	\$ _____	
		10140102	M10 - Nut only, no washer	Pale Eucalypt	ea	\$ _____	
		10140103	M10 - Nut only, no washer	Shale Grey	ea	\$ _____	
		10140104	M10 - Nut only, no washer	Paperbark	ea	\$ _____	
		10140105	M10 - Nut only, no washer	Pimento Red	ea	\$ _____	
		10140107	M10 - Nut only, no washer	Manor Red	ea	\$ _____	
		10140106	M10 - Nut only, no washer	Windspray	ea	\$ _____	
			M10 - Nut only, no washer	Custom	ea	\$ _____	
		10140150	M12 - Nut only, no washer	Surfmist	ea	\$ _____	
			M12 - Nut only, no washer	Custom	ea	\$ _____	
		10140189	M16 - No nut & no washer	Surfmist	ea	\$ _____	
		10140190	M10 with inbuilt washer	Surfmist	ea	\$ _____	

5 SUSPENSION COMPONENTS

5.1 COMPONENTS

5.1.11

WIRE & WIRE KITS

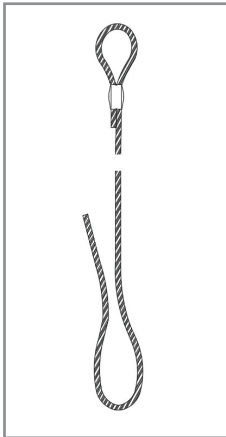
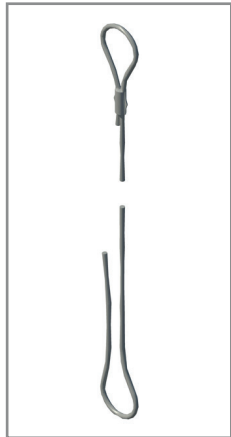

Item code:

Description:

Finish: Unit: Price:

10140200
10140201
10140202
10140204
10140206
10140208

2000mm Wire w/Swaged End
3000mm Wire w/Swaged End
4000mm Wire w/Swaged End
6000mm Wire w/Swaged End
8000mm Wire w/Swaged End
10000mm Wire w/Swaged End

Galv. ea \$ _____
Galv. ea \$ _____
Galv. ea \$ _____
Galv. ea \$ _____
Galv. ea \$ _____
Galv. ea \$ _____

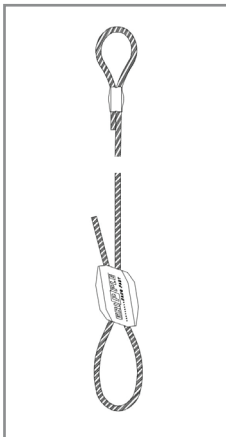

10140210
10140211
10140212
10140214
10140216
10140218

2000mm No.4 Gripple & Wire Kit
3000mm No.4 Gripple & Wire Kit
4000mm No.4 Gripple & Wire Kit
6000mm No.4 Gripple & Wire Kit
8000mm No.4 Gripple & Wire Kit
10000mm No.4 Gripple & Wire Kit

Galv. ea \$ _____
Galv. ea \$ _____
Galv. ea \$ _____
Galv. ea \$ _____
Galv. ea \$ _____
Galv. ea \$ _____

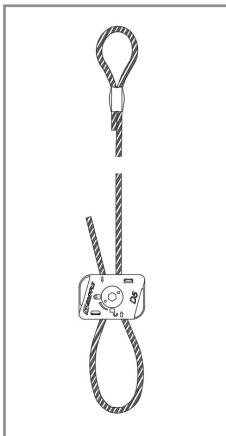

10140220
10140221
10140222
10140224
10140226
10140228

2000mm No.5 6mm Gripple & Wire Kit
3000mm No.5 6mm Gripple & Wire Kit
4000mm No.5 6mm Gripple & Wire Kit
6000mm No.5 6mm Gripple & Wire Kit
8000mm No.5 6mm Gripple & Wire Kit
10000mm No.5 6mm Gripple & Wire Kit

Galv. ea \$ _____
Galv. ea \$ _____
Galv. ea \$ _____
Galv. ea \$ _____
Galv. ea \$ _____
Galv. ea \$ _____

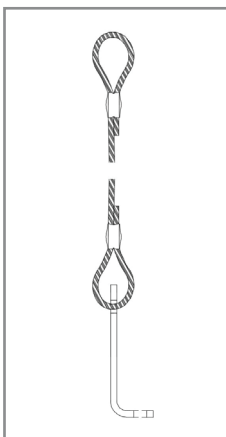

10140230
10140231
10140232
10140234
10140236
10140238

2000mm L-Bracket & Wire Kit
3000mm L-Bracket & Wire Kit
4000mm L-Bracket & Wire Kit
6000mm L-Bracket & Wire Kit
8000mm L-Bracket & Wire Kit
10000mm L-Bracket & Wire Kit

Galv. ea \$ _____
Galv. ea \$ _____
Galv. ea \$ _____
Galv. ea \$ _____
Galv. ea \$ _____
Galv. ea \$ _____

5 SUSPENSION COMPONENTS

5.1 COMPONENTS

		5.1.12	THREADED ROD			
		Item code:	Description:	Finish:	Unit:	Price:
		10140252	M10 200mm	Zinc Plated	ea	\$ _____
		10140253	M10 300mm	Zinc Plated	ea	\$ _____
		10140254	M10 400mm	Zinc Plated	ea	\$ _____
		10140256	M10 600mm	Zinc Plated	ea	\$ _____
		10140258	M10 1000mm	Zinc Plated	ea	\$ _____
		10140259	M10 3000mm	Zinc Plated	ea	\$ _____
		Note: Custom sizes are available - POA				
		10140262	M10 200mm	Galv.	ea	\$ _____
		10140263	M10 300mm	Galv.	ea	\$ _____
		10140264	M10 400mm	Galv.	ea	\$ _____
		10140266	M10 600mm	Galv.	ea	\$ _____
		10140268	M10 1000mm	Galv.	ea	\$ _____
		10140269	M10 3000mm	Galv.	ea	\$ _____
		Note: Custom sizes are available - POA				
		10140292	M12 200mm	Galv.	ea	\$ _____
		10140293	M12 300mm	Galv.	ea	\$ _____
		10140294	M12 400mm	Galv.	ea	\$ _____
		10140296	M12 600mm	Galv.	ea	\$ _____
		10140298	M12 1000mm	Galv.	ea	\$ _____
		10140299	M12 3000mm	Galv.	ea	\$ _____
		Note: Custom sizes are available - POA				
		10140272	M10 200mm	S/Steel	ea	\$ _____
		10140273	M10 300mm	S/Steel	ea	\$ _____
		10140274	M10 400mm	S/Steel	ea	\$ _____
		10140276	M10 600mm	S/Steel	ea	\$ _____
		10140278	M10 1000mm	S/Steel	ea	\$ _____
		10140279	M10 3000mm	S/Steel	ea	\$ _____
		Note: Custom sizes are available - POA				
		10140302	M12 200mm	S/Steel	ea	\$ _____
		10140303	M12 300mm	S/Steel	ea	\$ _____
		10140304	M12 400mm	S/Steel	ea	\$ _____
		10140306	M12 600mm	S/Steel	ea	\$ _____
		10140308	M12 1000mm	S/Steel	ea	\$ _____
		10140309	M12 3000mm	S/Steel	ea	\$ _____
		Note: Custom sizes are available - POA				

5 SUSPENSION COMPONENTS

5.2 SUSPENSION KITS

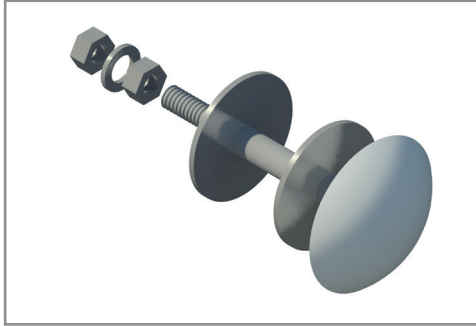

Item code:	Description:	Finish:	Unit:	Price:
10140350	M10 Wall	Galv.	ea	\$ _____
10140360	M10 Wall	S/Steel	ea	\$ _____
10140370	M10 Wall	Zinc	ea	\$ _____
10140380	M12 Wall	Galv.	ea	\$ _____
10140390	M12 Wall	S/Steel	ea	\$ _____

Note: Panel thickness required when placing order

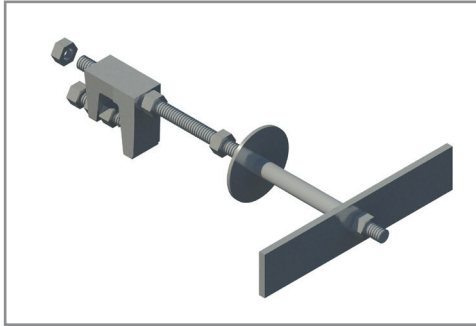

10140400	M10 Wall	Galv.	ea	\$ _____
10140410	M10 Wall	S/Steel	ea	\$ _____
10140420	M12 Wall	Galv.	ea	\$ _____
10140430	M12 Wall	S/Steel	ea	\$ _____

Note: Panel thickness required when placing order

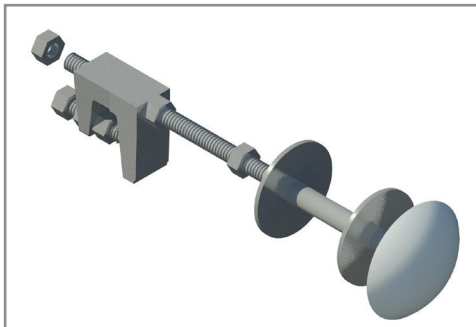

10140440	M10 Wall WSKB	Galv.	ea	\$ _____
10140450	M10 Wall WSKB	S/Steel	ea	\$ _____
10140460	M12 Wall WSKB	Galv.	ea	\$ _____
10140470	M12 Wall WSKB	S/Steel	ea	\$ _____

Note: Panel thickness required when placing order

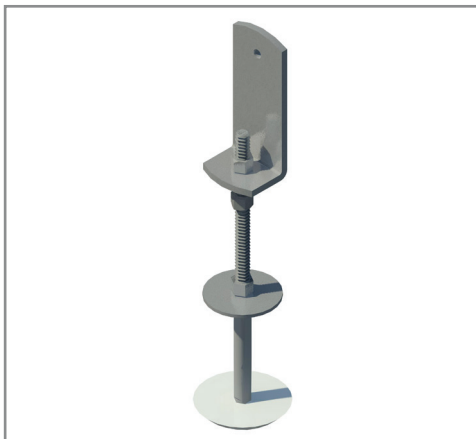

10140480	M10 Ceiling	Galv.	ea	\$ _____
10140490	M10 Ceiling	S/Steel	ea	\$ _____
10140500	M10 Ceiling	Zinc	ea	\$ _____
10140510	M12 Ceiling	Galv.	ea	\$ _____
10140520	M12 Ceiling	S/Steel	ea	\$ _____

Note: Panel thickness required when placing order

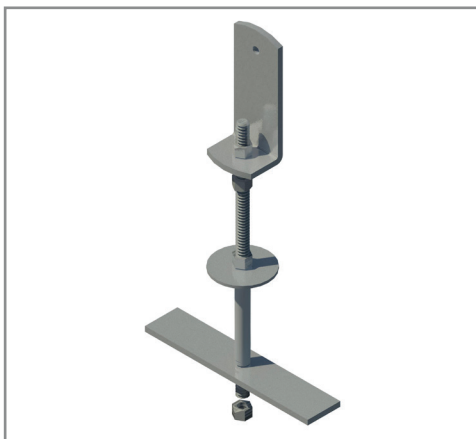

10140530	M10 'Major' Ceiling	Galv.	ea	\$ _____
10140540	M10 'Major' Ceiling	S/Steel	ea	\$ _____
10140550	M12 'Major' Ceiling	Galv.	ea	\$ _____
10140560	M12 'Major' Ceiling	S/Steel	ea	\$ _____

Note: Panel thickness required when placing order

6 DOOR ACCESSORIES

6.1 SWING DOOR ACCESSORIES

6.1.1

CLOSERS

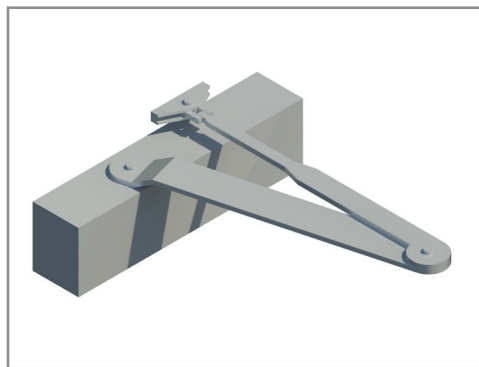

Item code:
10150000

Description:
Dorma TS83 EN 3-6 Heavy Duty Hydraulic Closer.
Aluminium body & S/Steel arm
Body Dimension: 225x60x46mm
Suits Flush Swing Doors

Unit: ea **Price:** \$ _____

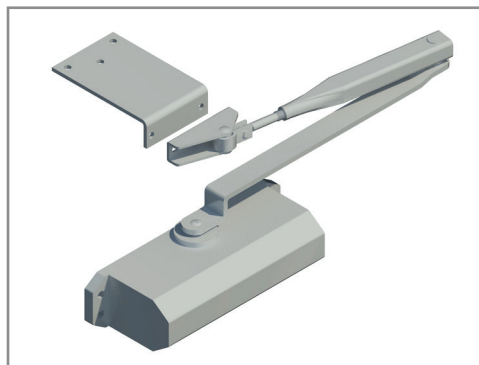

10150001

Dorma TS77BC Size 3
w/standard arm & parallel arm bracket
Body Dimension: 178x42x65mm
Suits Flush Swing Doors

ea \$ _____

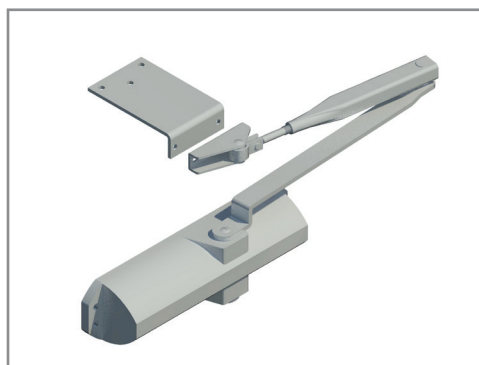

10150002

Dorma TS68 EN 2/3/4 BC
w/standard arm & parallel arm bracket
Body Dimension: 216x52x45mm
Suits Flush Swing Doors

ea \$ _____

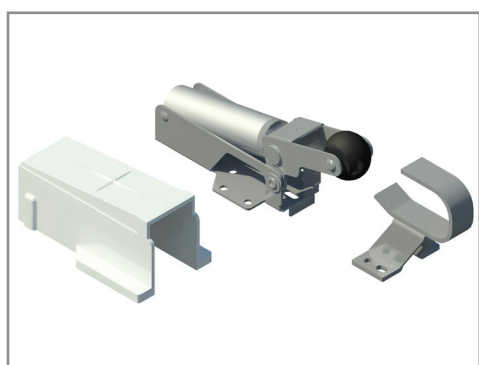

10150005

Kason Hydraulic Door Closer
Dimension: 112x50x58mm
Suits Face Swing Doors

ea \$ _____

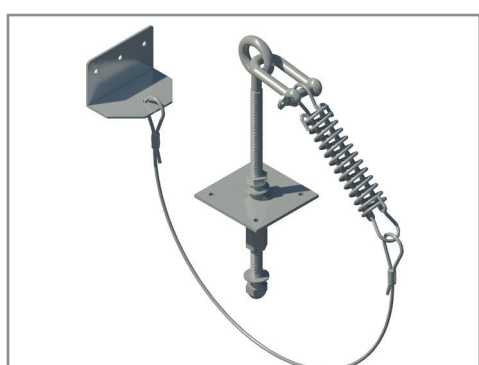

10150006

Storm Closer
Dimension: Approx 1000mm
Suits Face Swing Doors

S/Steel ea \$ _____

6 DOOR ACCESSORIES

6.1 SWING DOOR ACCESSORIES CONTINUED

6.1.2

HANDLES, LATCHES & LOCKS

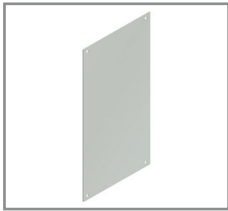

Item code:	Description:	Finish:	Unit:	Price:
10150010	Pull/Pull Set (plain)	S/Steel	ea	\$ _____
10150011	Pull Handle 300x150mm (plain)	S/Steel	ea	\$ _____

Note: Suits Flush Swing Doors

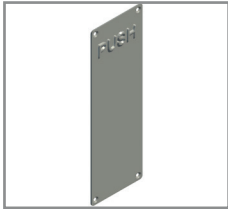

10150015	Pull/Push Set 300x 100mm w/text	S/Steel	ea	\$ _____
10150016	Pull Handle 300x100mm w/text	S/Steel	ea	\$ _____
10150017	Push Plate 300x100mm w/text	S/Steel	ea	\$ _____

Note: Suits Flush Swing Doors

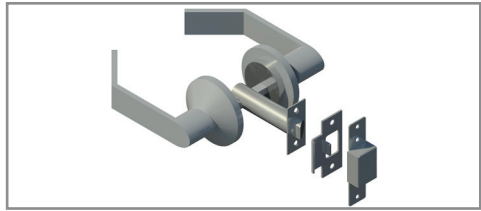

10150020	Carbine Passage Set for 35-75mm Doors Two Plain Handles Includes Carbine & Dust Box Suits Flush Swing Doors	Chrome	ea	\$ _____
----------	---	--------	----	----------

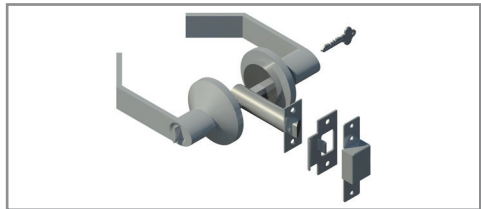

10150021	Carbine Entrance Set for 35-75mm Doors Two handles - Keylock & Inside snib Includes Carbine & Dust Box Suits Flush Swing Doors	Chrome	ea	\$ _____
----------	--	--------	----	----------

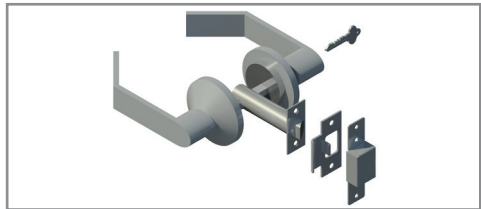

10150022	Carbine Escape Set for 35-75mm Doors Two handles - Keylock & Plain Handle Includes Carbine & Dust Box Suits Flush Swing Doors	Chrome	ea	\$ _____
----------	---	--------	----	----------

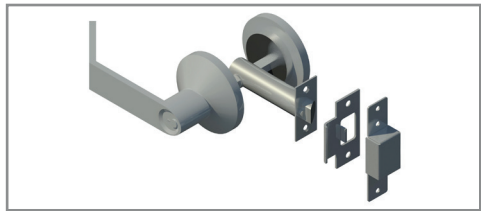

10150023	Carbine Half Lock Set for 35-75mm Doors Two handles - Half lock & Plate Only Includes Carbine & Dust Box Suits Flush Swing Doors	Chrome	ea	\$ _____
----------	--	--------	----	----------

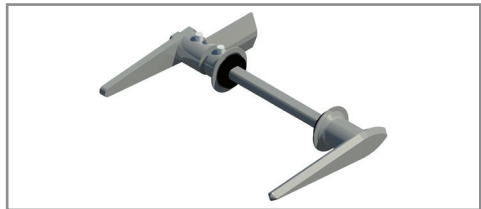

10150030	Ventlok260 Handle 100mm shaft Suits Flush Swing Doors	Chrome	ea	\$ _____
----------	--	--------	----	----------

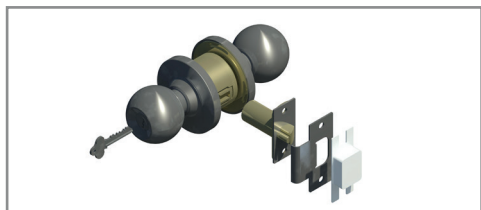

10150031	Ventlok260 Handle w/Extended shaft Suits Flush Swing Doors	Chrome	ea	\$ _____
----------	---	--------	----	----------



10150032	Boyd by Kaba K Series Suits Flush Swing Doors	Chrome	ea	\$ _____
----------	--	--------	----	----------

6 DOOR ACCESSORIES

6.1 SWING DOOR ACCESSORIES CONTINUED

6.1.2

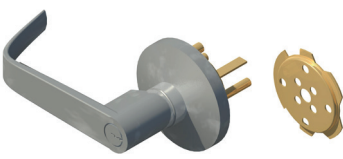
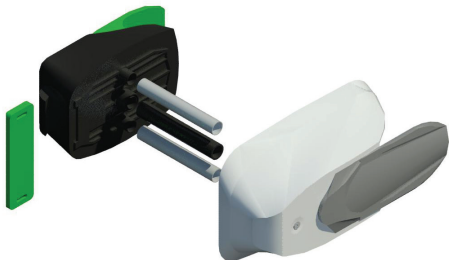
HANDLES, LATCHES & LOCKS

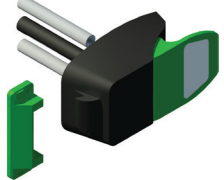
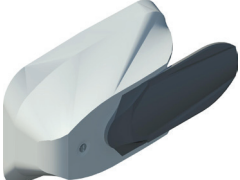
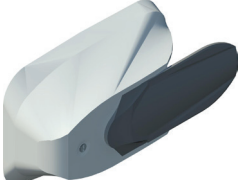
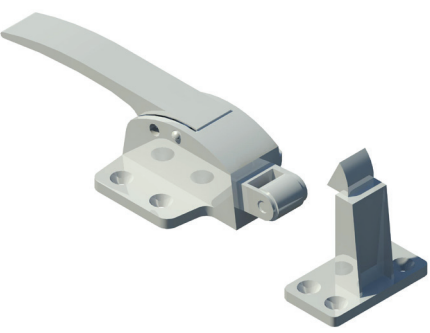
	Item code:	Description:	Finish:	Unit:	Price:
	10150040	Kaba 570 Rim Exit Device/Panic Bar Suits Flush & Face Swing Doors	S/Steel	ea	\$ _____
	10150041	Panic Bar Lever Handle Suits Flush Swing Doors Used inconjunction w/Kaba Panic Bar	Chrome	ea	\$ _____
	10150050	Fermody 431 key lockable w/ internal safety release Set Suits Face Swing Doors	PVC	ea	\$ _____
	10150051	Fermody 431 (no lock) w/ internal safety release Set Suits Face Swing Doors	PVC	ea	\$ _____
	10150052	Internal Release Only Suits Face Swing Doors	PVC	ea	\$ _____
	10150053	Latch set with lock Suits Face Swing Doors	PVC	ea	\$ _____
	10150054	Latch set (no lock) Suits Face Swing Doors	PVC	ea	\$ _____
	10150060	Cabinet Latch w/25-38mm adjustable strike Suits Face Swing Doors	Chrome Plated	ea	\$ _____

6 DOOR ACCESSORIES

6.1 SWING DOOR ACCESSORIES CONTINUED

6.1.2

HANDLES, LATCHES & LOCKS

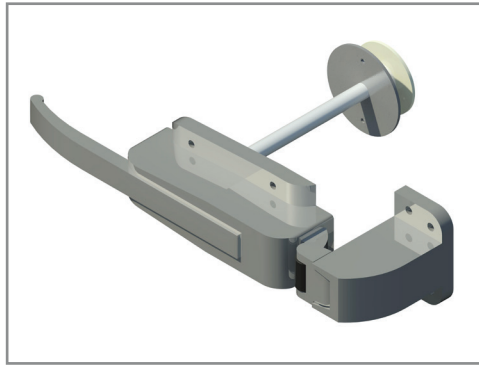

Item code:	Description:	Finish:	Unit:	Price:
10150070	Kason K56 Complete Set Suits Face Swing Doors	Chrome	ea	\$ _____

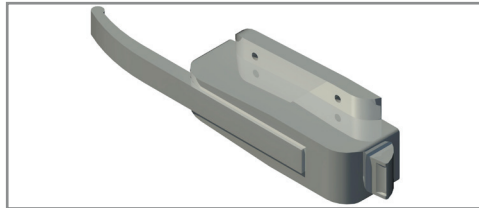

10150071	Kason K56 Safeguard Latch Body Suits Face Swing Doors	Chrome	ea	\$ _____
----------	--	--------	----	----------

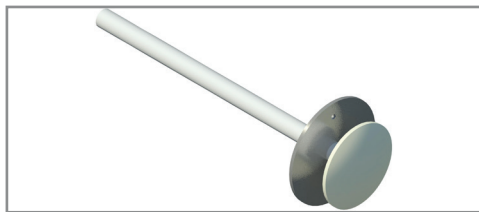

10150072	Kason K56 Release Push Handle 6" Suits Face Swing Doors		ea	\$ _____
----------	--	--	----	----------

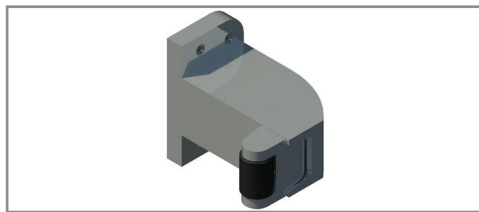

10150073	Kason K56 Flush Strike 1/8"	Chrome	ea	\$ _____
10150074	Kason K56 Strike 3/4"	Chrome	ea	\$ _____
10150075	Kason K56 Strike 3" - 6"	Chrome	ea	\$ _____

Note: Suits Face Swing Doors

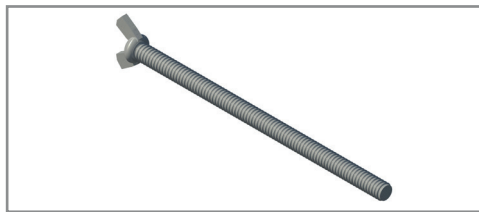

10150080	M10 Safety Release Bolt Dimension: 200mm Suits Face Swing Doors		ea	\$ _____
----------	---	--	----	----------

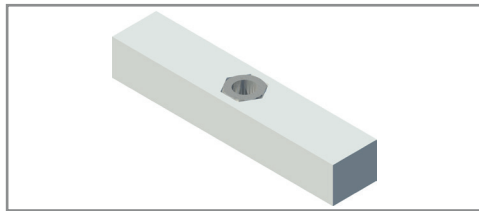

10150090	Safety Release Block w/M10 Nut Dimension: 125x25x20mm Suits Face Swing Doors		ea	\$ _____
----------	--	--	----	----------

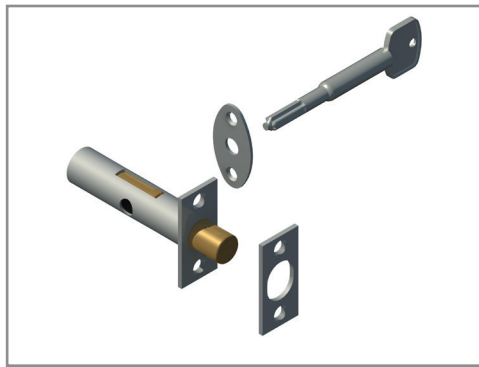

10150100	Guardian Security Bolt Dimension: 20x40x64mm Suits Flush Swing Doors		ea	\$ _____
----------	--	--	----	----------

6 DOOR ACCESSORIES

6.1 SWING DOOR ACCESSORIES CONTINUED

6.1.2

HANDLES, LATCHES & LOCKS

		Item code:	Description:	Finish:	Unit:	Price:
		10150110	100mm Skeleton bolt	S/Steel	ea	\$ _____
		10150111	150mm Skeleton bolt	S/Steel	ea	\$ _____
		10150112	200mm Skeleton bolt	S/Steel	ea	\$ _____
		10150113	300mm Skeleton bolt	S/Steel	ea	\$ _____
		10150114	600mm Skeleton bolt	S/Steel	ea	\$ _____
		10150115	1000mm Skeleton bolt	Chrome	ea	\$ _____
		10150116	1500mm Skeleton bolt	Chrome	ea	\$ _____
		Note: Suits Flush Swing Doors				
		10150120	100mm Padbolt	Zinc Plated	ea	\$ _____
		10150121	150mm Padbolt	Zinc Plated	ea	\$ _____
		10150122	200mm Padbolt	Zinc Plated	ea	\$ _____
		Note: Suits Flush Swing Doors				
		10150130	Lockwood Toilet Latch Lock Dimension: 70x40mm Display Dimension: 45 x 60mm Suits Flush Swing Doors		ea	\$ _____
		10150131	Manual Flush Bolt Dimension: 150x50x18mm Suits Flush Swing Doors		ea	\$ _____
		10150132	Automatic Flush Bolt Dimension: 154x216x51mm Suits Flush Swing Doors		ea	\$ _____

6 DOOR ACCESSORIES

6.1 SWING DOOR ACCESSORIES CONTINUED

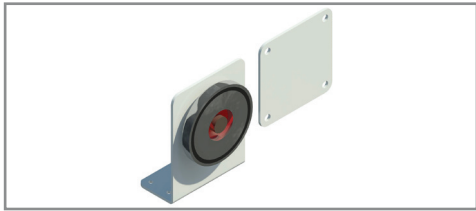

6.1.2 MAGNETIC LOCK

Item code:	Description:	Finish:	Unit:	Price:
10150140	Magnetic Lock Set	S/Steel	ea	\$ _____

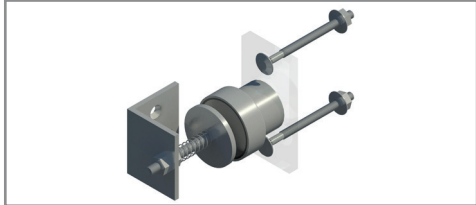

10150150	B1 Magnetic Lock Set suits light to medium duty doors	S/Steel	ea	\$ _____
10150151	B2 Magnetic Lock Set suits medium duty doors	S/Steel	ea	\$ _____

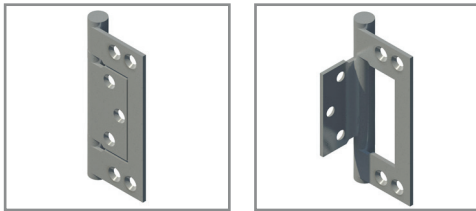

6.1.3 HINGES

Item code:	Description:	Finish:	Unit:	Price:
10150160	Hirline Hinge Suits Flush Swing Doors	S/Steel	ea	\$ _____

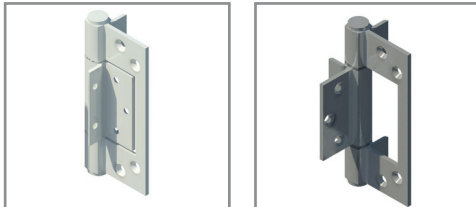

10150170	Fast Fix Aluminium Hinge	Surfmist	ea	\$ _____
10150171	Fast Fix Aluminium Hinge	Anodised	ea	\$ _____
10150172	Fast Fix Aluminium Hinge	S/Steel	ea	\$ _____

Note: Suits Flush Swing Doors

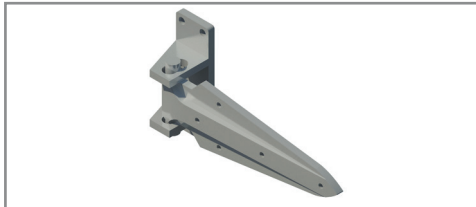

10150180	Kason Hinge Dimension: 160x310mm Suits Face Swing Doors		ea	\$ _____
----------	---	--	----	----------

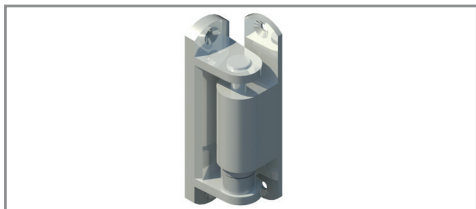

10150190	P11 Self Closing Hinge - Left Hand Dimension: 110mm	Chrome Pl	ea	\$ _____
10150191	P11 Self Closing Hinge - Right Hand Dimension: 110mm	Chrome Pl	ea	\$ _____

Note: Suits Face Swing Doors

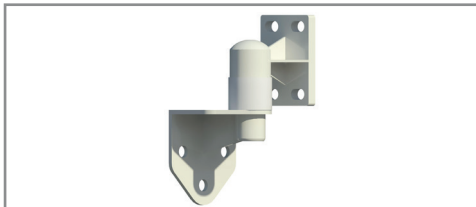

10150195	Poly Cam	Surfmist	ea	\$ _____
10150196	Suits Face Swing Doors	Mill	ea	\$ _____

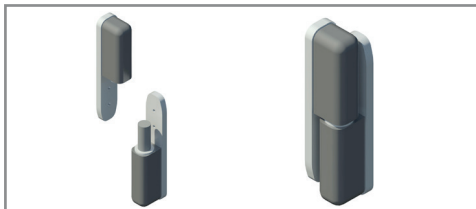

10150200	Fermod Camrise Adjustable Composite Self Closing Hinge 205mm Suits Face Swing Doors	PVC	ea	\$ _____
----------	---	-----	----	----------

6 DOOR ACCESSORIES

6.1 SWING DOOR ACCESSORIES CONTINUED

6.1.3

HINGES

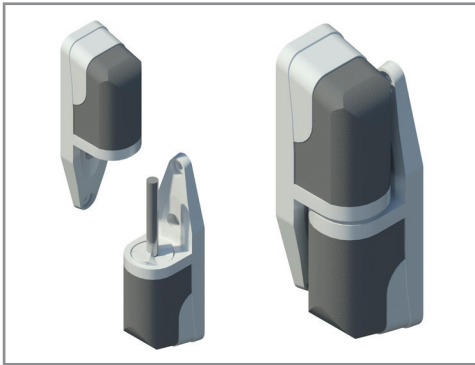

Item code:	Description:	Finish:	Unit:	Price:
10150201	Fermod Camrise Adjustable Composite Self Closing Hinge - Large 280mm Suits Face Swing Doors	PVC	ea	\$ _____

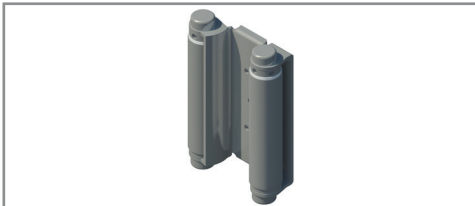

10150210	JMA Double Action Spring Hinge Dimension: 125mm Suits Flush Swing Doors	S/Steel	ea	\$ _____
----------	---	---------	----	----------

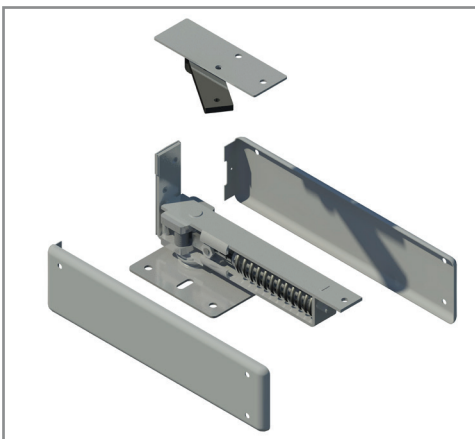

10150220	Kaba Double Action Floor Spring Hinge Dimension: 215x100x100mm Suits Flush Swing Doors		ea	\$ _____
----------	--	--	----	----------

6.1.4

MISCELLANEOUS

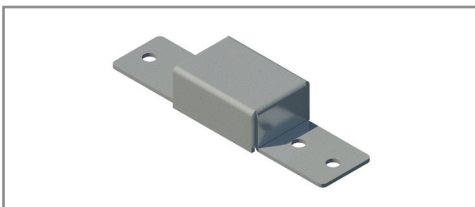

Item code:	Description:	Finish:	Unit:	Price:
10150230	Carbine Lock Box to Doorjam Dimension: 70x30mm Suits Flush Swing Doors		ea	\$ _____







10150590	Emergency Door Label Suits Face Swing Doors		ea	\$ _____
----------	--	--	----	----------

6 DOOR ACCESSORIES

6.2 SLIDING DOOR ACCESSORIES

6.2.1

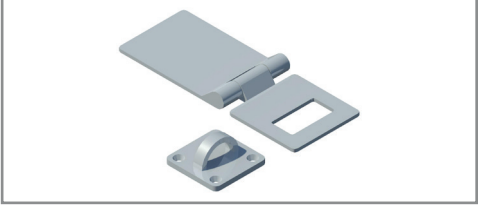
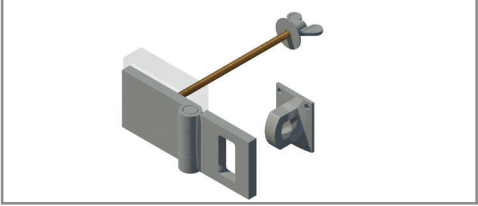
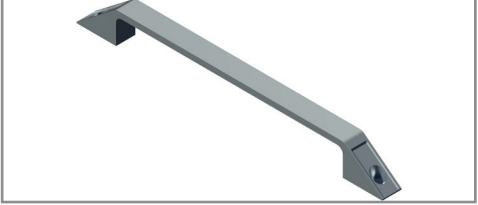
HANDLES/LATCHES

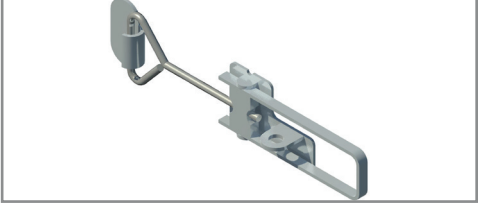
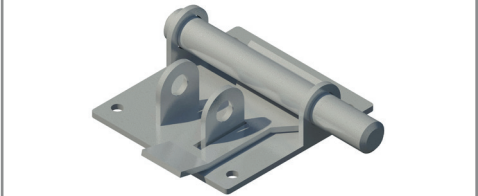
	Item code:	Description:	Finish:	Unit:	Price:
	10150240	Side Mounted Slider Handle	PVC	ea	\$ _____
	10150250	Sliding Door Lock		ea	\$ _____
	10150260	75mm Hasp & Staple Set	Chrome Plated	ea	\$ _____
	10150261	100mm Hasp & Staple Set	Chrome Plated	ea	\$ _____
	10150262	150mm Hasp & Staple Set	Chrome Plated	ea	\$ _____
	10150263	200mm Hasp & Staple Set	Chrome Plated	ea	\$ _____
	10150270	75mm Master Lock Kit	Chrome Plated	ea	\$ _____
	10150271	100mm Master Lock Kit	Chrome Plated	ea	\$ _____
	10150272	150mm Master Lock Kit	Chrome Plated	ea	\$ _____
	10150273	200mm Master Lock Kit	Chrome Plated	ea	\$ _____
	10150274	300mm Master Lock Kit	Chrome Plated	ea	\$ _____
	10150280	Die Cast Pull Handle	Chrome Plated	ea	\$ _____
	10150281	Pull Handle - JAM4038-8 330x20mm		ea	\$ _____
	10150290	Hook & Catch Fastener		ea	\$ _____
	10150291	Side Mounted Latch		ea	\$ _____

6 DOOR ACCESSORIES

6.2 SLIDING DOOR ACCESSORIES CONTINUED

6.2.1

HANDLES/LATCHES

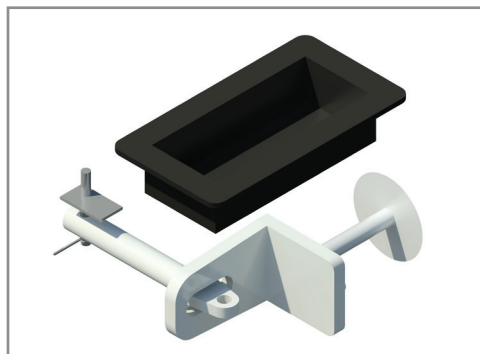

Item code:	Description:	Finish:	Unit:	Price:
10150300	75mm Sliding Door Lock Kit		ea	\$ _____
10150301	100mm Sliding Door Lock Kit		ea	\$ _____
10150302	150mm Sliding Door Lock Kit		ea	\$ _____
10150303	200mm Sliding Door Lock Kit		ea	\$ _____
10150304	250mm Sliding Door Lock Kit		ea	\$ _____
10150305	300mm Sliding Door Lock Kit		ea	\$ _____



10150310	Insert Pocket	PVC White	ea	\$ _____
10150311	Insert Pocket	PVC Black	ea	\$ _____

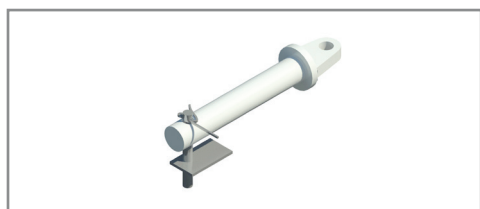

10150312	Release Pin & Swivel	Surfmist	ea	\$ _____
10150313	Release Pin & Swivel	Mill	ea	\$ _____

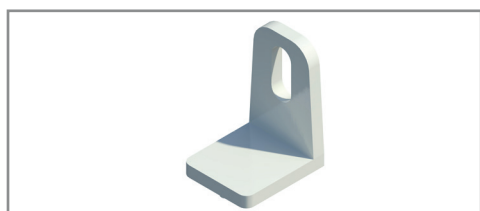

10150314	Hasp	Surfmist	ea	\$ _____
10150315	Hasp	Mill	ea	\$ _____

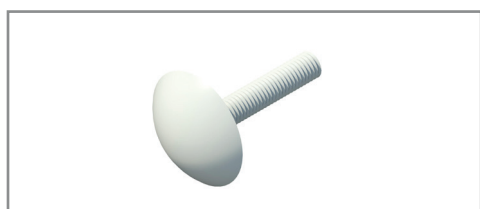

10150316	M16 100mm Mushroom Bolt	Surfmist	ea	\$ _____
10150317	M16 150mm Mushroom Bolt	Surfmist	ea	\$ _____
10150318	M16 200mm Mushroom Bolt	Surfmist	ea	\$ _____
10150319	M16 300mm Mushroom Bolt	Surfmist	ea	\$ _____

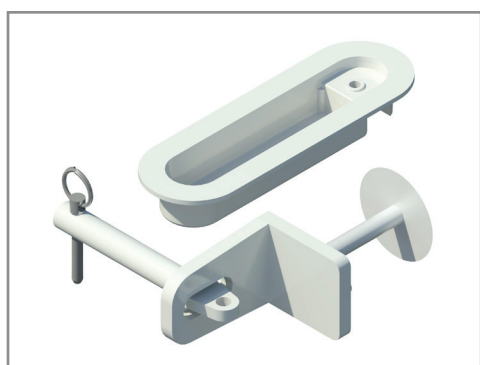

10150330	75mm Sliding Door Lock Kit		ea	\$ _____
10150331	100mm Sliding Door Lock Kit		ea	\$ _____
10150332	150mm Sliding Door Lock Kit		ea	\$ _____
10150333	200mm Sliding Door Lock Kit		ea	\$ _____
10150334	250mm Sliding Door Lock Kit		ea	\$ _____
10150335	300mm Sliding Door Lock Kit		ea	\$ _____

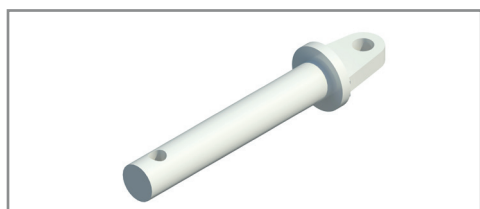







10150340	Lock Tube	Surfmist	ea	\$ _____
10150341	Lock Tube	Mill	ea	\$ _____

6 DOOR ACCESSORIES

6.2 SLIDING DOOR ACCESSORIES CONTINUED

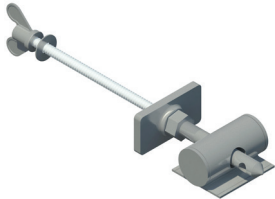
6.2.1

HANDLES/LATCHES

	Item code:	Description:	Finish:	Unit:	Price:
	10150342	Safety Release Pin 77mm for Recess Handle		ea	\$ _____
	10150343	Recessed Handle - Blank 258x83mm	Surfmist	ea	\$ _____
	10150345	Recessed Handle - Tapped 258x83mm	Surfmist	ea	\$ _____
	10150350	Recessed Handle HAN004 347x120mm	Surfmist	ea	\$ _____
	10150360	Bayonet Assembly Kit with Shoulder		ea	\$ _____
	Tube Bar w/Centre Bracket Assembly				
	10150370	Tube Handle Centre Bracket 257x51mm	Surfmist	ea	\$ _____
	10150371	Tube Handle Centre Bracket 257x51mm	Anodised	ea	\$ _____
	10150372	Tube Handle Centre Bracket 327x85mm	Surfmist	ea	\$ _____
	10150373	Tube Handle Centre Bracket 327x85mm	Anodised	ea	\$ _____
	10150380	Tube Handle End Bracket 175x50mm	Surfmist	ea	\$ _____

6 DOOR ACCESSORIES

6.2 SLIDING DOOR ACCESSORIES CONTINUED

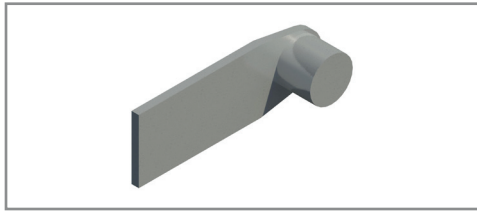

6.2.1

HANDLES/LATCHES

Item code:	Description:	Finish:	Unit:	Price:
10150382	Tube Handle End Bracket 150x52mm	Anodised	ea	\$ _____
10150381	Tube Handle End Bracket 150x52mm	Surfmist	ea	\$ _____
10150390	Recessed Handle Double Sided 180x200mm	Black	ea	\$ _____

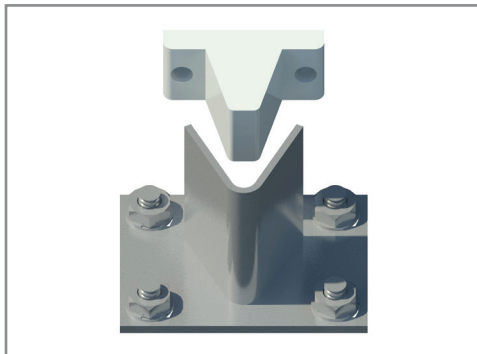
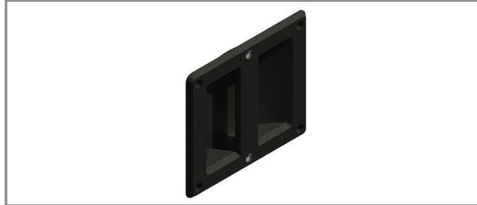

6.2.2

DOOR STOPS

Item code:	Description:	Finish:	Unit:	Price:
10150400	PC Cone & Locator includes 4 Dynabolts	S/Steel	ea	\$ _____
10150401	PC Cone & Locator includes 4 Dynabolts	Galv.	ea	\$ _____



10150402	Cone Only	Surfmist	ea	\$ _____
----------	-----------	----------	----	----------

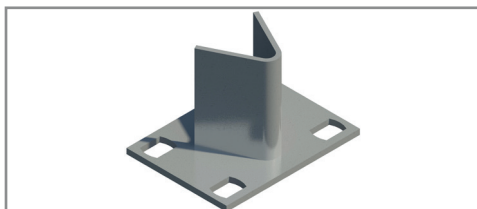

10150403	Locator Only	S/Steel	ea	\$ _____
10150404	Locator Only	Galv.	ea	\$ _____

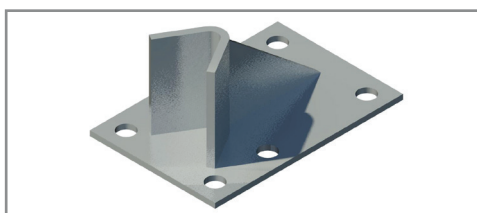

10150405	Locator Only - Large (Coles)	S/Steel	ea	\$ _____
----------	------------------------------	---------	----	----------

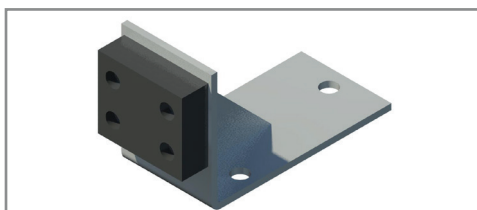





10150410	Door Stop - Large (Coles)	S/Steel	ea	\$ _____
----------	---------------------------	---------	----	----------

6 DOOR ACCESSORIES

6.2 SLIDING DOOR ACCESSORIES CONTINUED

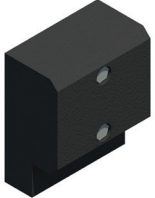
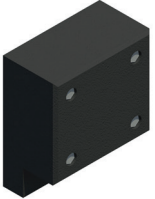
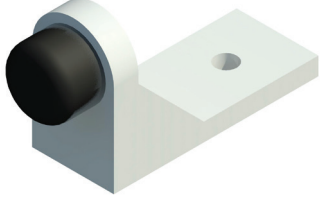
6.2.2

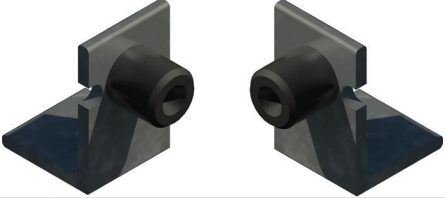
DOOR STOPS

	Item code:	Description:	Finish:	Unit:	Price:
	10150411	Track Stop Block w/Screws (Coles)	Rubber	ea	\$ _____
	10150420	Commercial Track Stop Block w/Screws - Small	Rubber	ea	\$ _____
	10150421	Industrial Track Stop Block w/Screws - Large	Rubber	ea	\$ _____
	10150430	Track mount door stop - Small	Aluminium	ea	\$ _____
	10150431	Floor mount door stop - Large	Aluminium	ea	\$ _____
	10150432	Door Stop - Rubber only	Rubber	ea	\$ _____
	10150435	J Track Stop Left & Right	Mill	ea	\$ _____
	10150440	Door Stop & Bolt	Rubber	ea	\$ _____

6 DOOR ACCESSORIES

6.2 SLIDING DOOR ACCESSORIES CONTINUED

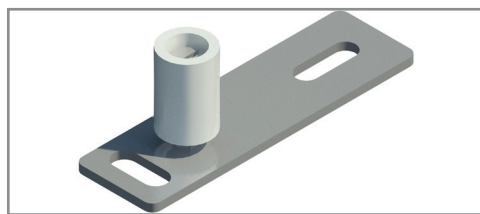

6.2.3

DOOR GUIDES

Item code:	Description:	Finish:	Unit:	Price:
10150452	Door Floor Guide H-Type	Galv.	ea	\$ _____
10150450	Door Floor Guide H-Type	Surfmist	ea	\$ _____
10150451	Door Floor Guide H-Type	S/Steel	ea	\$ _____

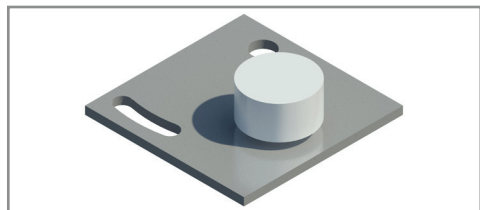

10150462	Door Floor Guide	Galv.	ea	\$ _____
10150460	Door Floor Guide	Surfmist	ea	\$ _____
10150461	Door Floor Guide	S/Steel	ea	\$ _____

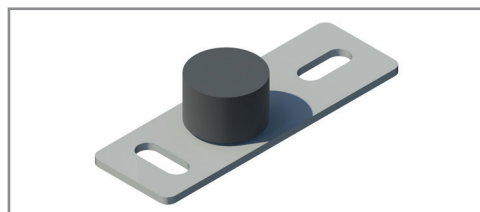

10150470	Sill Less Roller Guide	S/Steel	ea	\$ _____
----------	------------------------	---------	----	----------

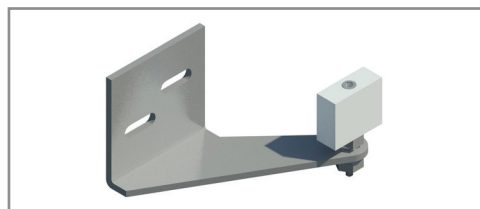

10150481	Trailing Edge Bracket	S/Steel	ea	\$ _____
----------	-----------------------	---------	----	----------



10150490	Leading Edge Keeper	S/Steel	ea	\$ _____
----------	---------------------	---------	----	----------

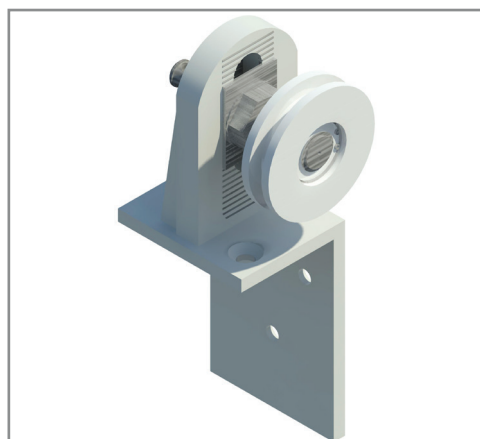

6.2.4

ROLLERS

Item code:	Description:	Finish:	Unit:	Price:
10150500	75mm Single Roller Kit - Left		ea	\$ _____
10150501	75mm Single Roller Kit - Right		ea	\$ _____

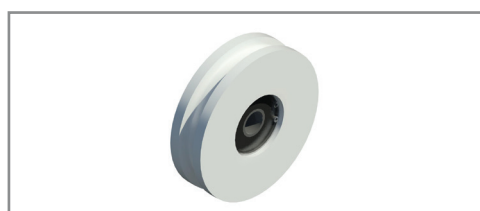

10150510	70mm Delrin wheel, bearing and circlip	Derlin	ea	\$ _____
	15mm bearing ID			

10150504	75mm Delrin wheel, bearing and circlip	Derlin	ea	\$ _____
	15mm bearing ID			

6 DOOR ACCESSORIES

6.2 SLIDING DOOR ACCESSORIES CONTINUED

6.2.4

ROLLERS

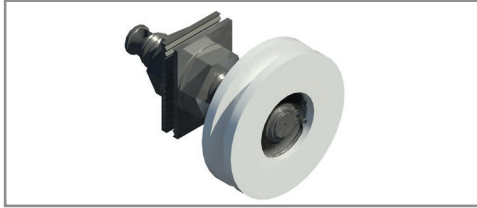

Item code:

Description:

Finish:

Unit:

Price:

10150511

70mm Derlin wheel & axel assembly

ea

\$ _____

10150505

75mm Derlin wheel & axel assembly

ea

\$ _____

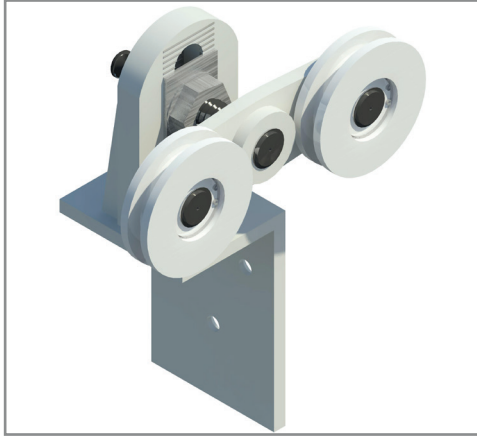

10150502

75mm Double Roller Kit - Left

ea

\$ _____

10150503

75mm Double Roller Kit - Right

ea

\$ _____

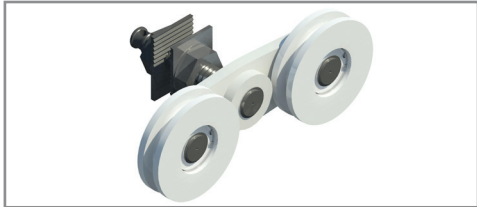

10150512

70mm Double Derlin wheel & axel assembly

ea

\$ _____

10150506

75mm Double Derlin wheel & axel assembly

ea

\$ _____



10150507

75mm Bracket Only - Left

ea

\$ _____

10150508

75mm Bracket Only - Right

ea

\$ _____

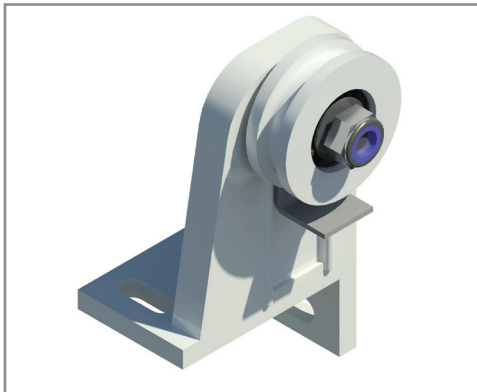

10150520

55mm Roller & Bracket Kit - Left

ea

\$ _____

10150521

55mm Roller & Bracket Kit - Right

ea

\$ _____

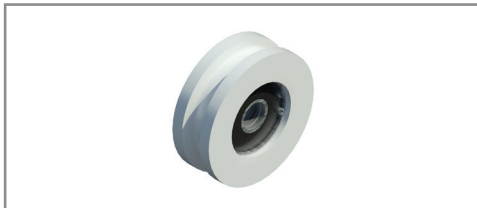

10150522



55mm Delrin wheel, bearing and circlip Derlin
15mm bearing ID

ea

\$ _____

6 DOOR ACCESSORIES

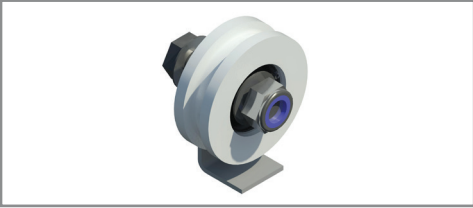
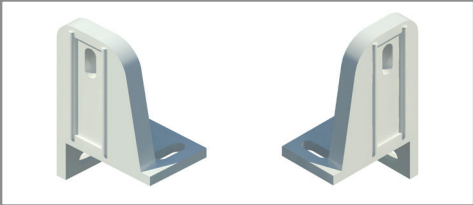
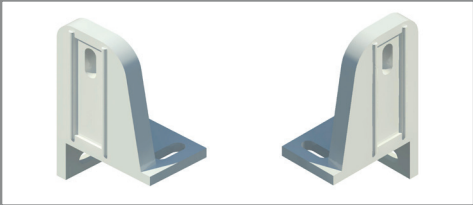
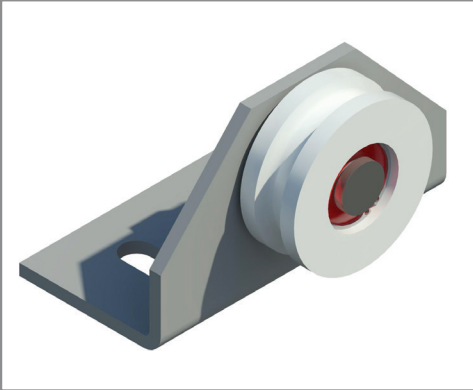
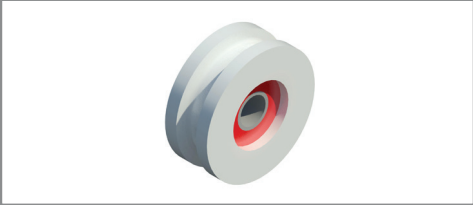
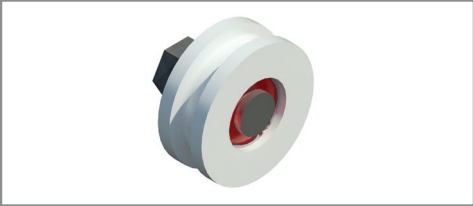
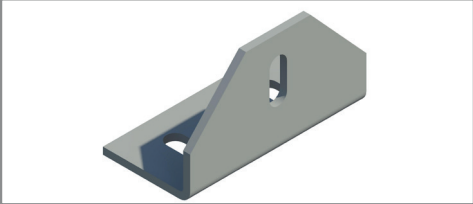
6.2 SLIDING DOOR ACCESSORIES CONTINUED

6.2.4		ROLLERS				
Item code:	Description:	Finish:	Unit:	Price:		
	10150523	55mm Delrin wheel & axel assembly	ea	\$	_____	
	10150524	55mm Bracket Only - Left	ea	\$	_____	
	10150525	55mm Bracket Only - Right	ea	\$	_____	
	10150530	50mm Hanging Roller & Bracket Kit	ea	\$	_____	
	10150531	50mm Delrin wheel, bearing and circlip 15mm bearing ID	ea	\$	_____	
	10150532	50mm Delrin wheel & axel assembly	ea	\$	_____	
	10150533	50mm Bracket Only	S/Steel	ea	\$	_____
	10150580	Offset Axle	ea	\$	_____	

6 DOOR ACCESSORIES

6.2 SLIDING DOOR ACCESSORIES CONTINUED

6.2.4

ROLLERS

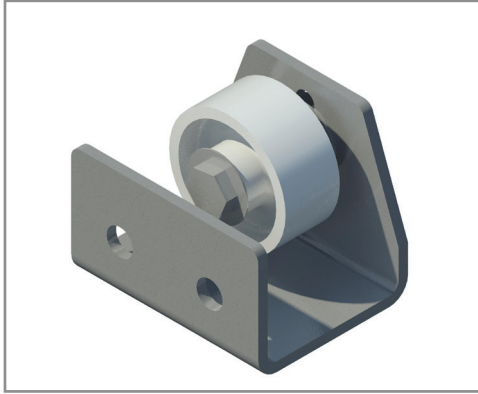

Item code:

Description:

Finish:

Unit:

Price:

10150540

75mm Roller & Bracket Kit

S/Steel

ea

\$_____

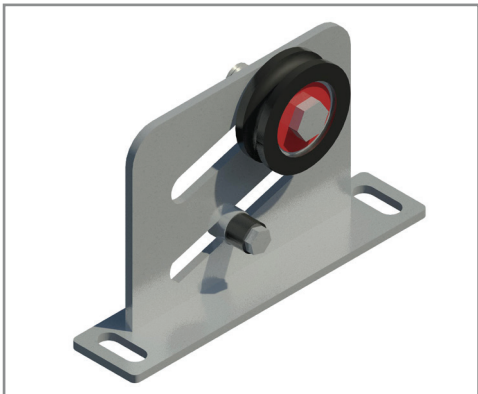

10150550

50mm Roller & Bracket Kit

S/Steel

ea

\$_____

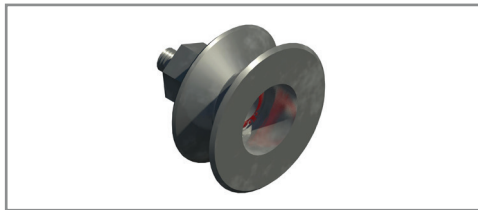

10150560

80mm Steel wheel & axel assembly

S/Steel

ea

\$_____

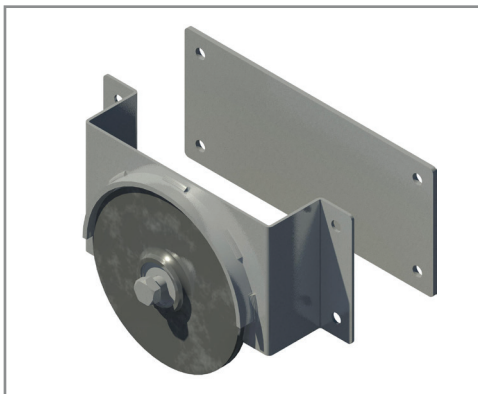

10150570

185mm Uplift Pulley Wheel

Galv.

ea

\$_____

6 DOOR ACCESSORIES

6.2 SLIDING DOOR ACCESSORIES CONTINUED

6.2.5		LABELS	
Item code:	Description:	Unit:	Price:
10150591	Emergency sliding door exit label	ea	\$ _____
10150592	Emergency sliding door exit label	ea	\$ _____
10150593	Emergency sliding door exit label for recessed handle	ea	\$ _____
10150594	Emergency sliding door exit label Dimension: 127x77mm	ea	\$ _____
10150595	Emergency sliding door exit label Dimension: 143x75mm	ea	\$ _____

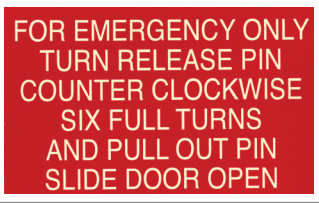
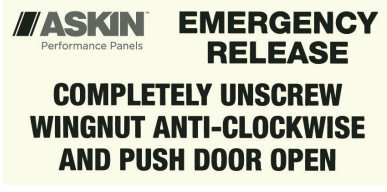

6 DOOR ACCESSORIES

6.3 UNIVERSAL DOOR ACCESSORIES

		6.3.1	GASKETS			
		Description:	Finish:	Item code:	Unit:	Price:
		Nitrol Pressure Seal (Flush Door)	Grey	10150700	mt	\$ _____
		Nitrol Pressure Seal (Face Door)	Grey	10150701	mt	\$ _____
		Nitrol Pressure Seal (Face Door) Pre-welded Kit		10150702	mt	\$ _____
		Nitrol Bottom Seal (Flush Door)	Grey	10150703	mt	\$ _____
		Nitrol Bottom Seal (Face Door)	Grey	10150704	mt	\$ _____
		Neoprene Hub Seal Gasket	Black	10150706	mt	\$ _____
		Silicone Hub Seal Gasket	Black	10150707	mt	\$ _____
		Rubber D Gasket	Black	10150708	mt	\$ _____
		Rubber 120x3mm Wiper Gasket	Black	10150718	mt	\$ _____
		Silicone 120x3mm Wiper Gasket	White	10150719	mt	\$ _____
		9x5 Stick-on Foam Door Jam Gasket	Grey	10150720	mt	\$ _____
		9x6 Stick-on Foam Door Jam Gasket	Black	10150721	mt	\$ _____
		12x6 Stick-on Foam Door Jam Gasket	Black	10150722	mt	\$ _____
		32x1.6 Stick-on Foam Door Jam Gasket	Black	10150723	mt	\$ _____

6 DOOR ACCESSORIES

6.3 UNIVERSAL DOOR ACCESSORIES CONTINUED

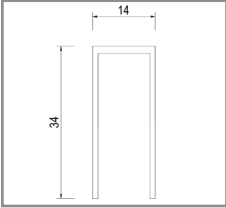
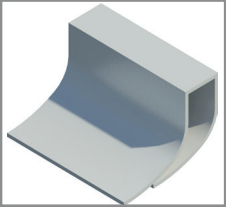
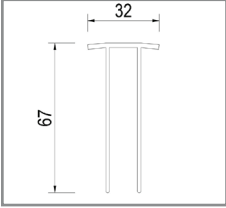
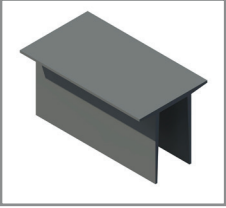
		6.3.1	GASKETS			
		Description:	Finish:	Item code:	Unit:	Price:
		Rubber 2 Finger Gasket 14x34mm	Black	10150709	mt	\$ _____
		Nitrol 2 Finger Gasket 14x34mm	Grey	10150710	mt	\$ _____
		Nitrol 2 Finger Gasket 14x53mm	Grey	10150711	mt	\$ _____
		Silicone 2 Finger Gasket 15x35mm	Grey	10150712	mt	\$ _____
		Nitrol Bottom Seal Gasket (Face Door)	Grey	10150705	mt	\$ _____
		Gasket 2 Prong 32x67mm	Grey	10150716	mt	\$ _____
		Gasket 2 Prong 006	Grey	10150717	mt	\$ _____
		Silicone 2 Finger Gasket 003	Grey	10150714	mt	\$ _____
		Silicone 2 Finger Gasket	Grey	10150715	mt	\$ _____

6 DOOR ACCESSORIES

6.3 UNIVERSAL DOOR ACCESSORIES CONTINUED

6.3.2

HEATING

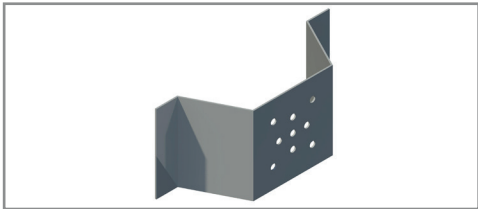
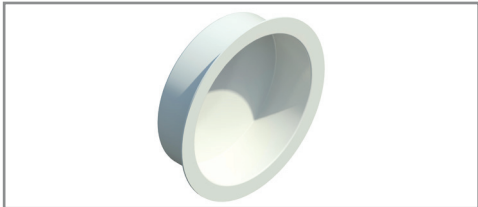
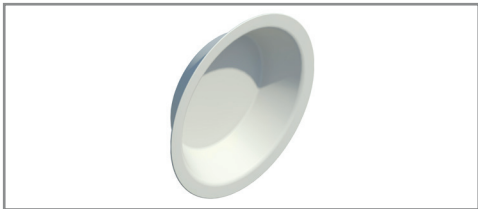
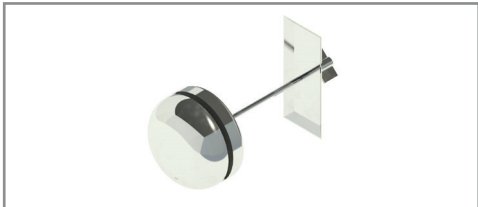
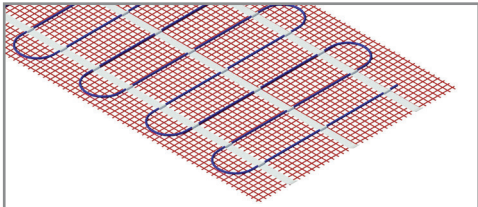
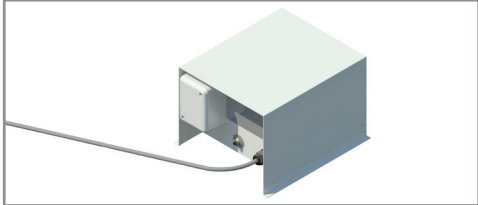

Item code:

Description:

Unit: Price:

10150800	10WATT Heater Cable	ea	\$ _____
10150801	15WATT Heater Cable	ea	\$ _____
10150802	Low Voltage Heater Cable	ea	\$ _____
10150803	Low Voltage Heater Kit	ea	\$ _____
10150850	Low Voltage Tranformer	ea	\$ _____

10150860	Heater Tail Kit	ea	\$ _____
----------	-----------------	----	----------

Heater Mats	p/m ²	\$ _____
-------------	------------------	----------

Under floor heating available. Please ask your local ASKIN representative for more information.

6.3.3

DOOR BELL COMPONENTS

Item code:

Description:

Finish:

Unit: Price:

10150900	Door Bell - 78mm Diameter Brass/Chrome Plated with S/Steel square key	ea	\$ _____
----------	---	----	----------

10150901	Bell Dish - 165mm Diameter	Surfmist	ea	\$ _____
----------	----------------------------	----------	----	----------

10150902	Bell Dish - 165mm Diameter	Mil	ea	\$ _____
----------	----------------------------	-----	----	----------

10150903	Bell Dish - 145mm Diameter	Surfmist	ea	\$ _____
----------	----------------------------	----------	----	----------

10150904	Bell Dish - 145mm Diameter	Mil	ea	\$ _____
----------	----------------------------	-----	----	----------

10150905	Bell Cover	S/Steel	ea	\$ _____
----------	------------	---------	----	----------

6 DOOR ACCESSORIES

6.3 UNIVERSAL DOOR ACCESSORIES CONTINUED

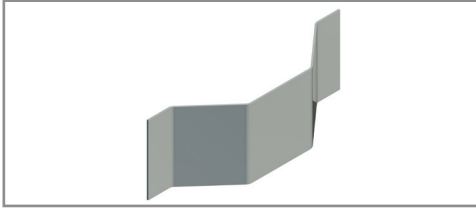

6.3.3

DOOR BELL COMPONENTS CONTINUED

Item code:	Description:	Finish:	Unit:	Price:
10150906	Bell Cover (Plain)	S/Steel	ea	\$ _____

7 WINDOWS

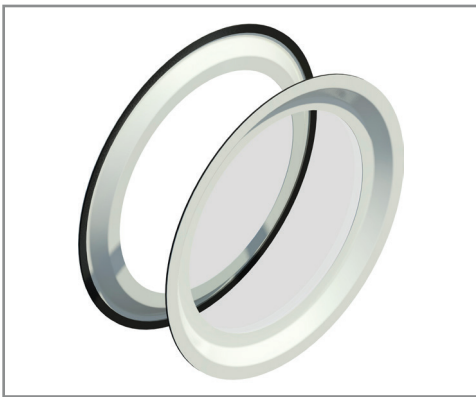

Item code:	Description:	Finish:	Unit:	Price:
10151000	38mm Aluminium View Hole Window	Glass	ea	\$ _____
10151001	50mm Aluminium View Hole Window	Glass	ea	\$ _____
10151002	75mm Aluminium View Hole Window	Glass	ea	\$ _____
10151003	100mm Aluminium View Hole Window	Glass	ea	\$ _____
10151010	38mm Aluminium View Hole Window	Polycarb	ea	\$ _____
10151011	50mm Aluminium View Hole Window	Polycarb	ea	\$ _____
10151012	75mm Aluminium View Hole Window	Polycarb	ea	\$ _____
10151013	100mm Aluminium View Hole Window	Polycarb	ea	\$ _____

ASKIN makes a wide variety of custom windows to suit any project. Below is a list of different options you can choose from to create the most appropriate window for your circumstances. Please ask an ASKIN representative for more information.

- Frame:** Aluminium
PVC
Composite Frames
- Type:** Sliding
Fixed
- Shape:** Square
Round

- Glazing Material:** Glass
Polycarb
- Glazing:** Single Glazed
Double Glazed
Double Glazed & Argon Filled
Triple Glazed
Triple Glazed & Argon Filled

- Heating:** Heated
Non-Heated
- Special:** 45 Degree Sill
Safety Films

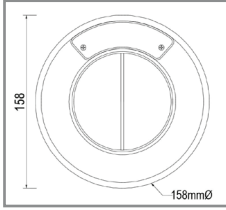

Description: Nordon Pressure Relief Port
 Temperature Range: +1° to -25°C
 Room Volume: 1 per each 40m³
 Composition: Polypropylene
 Cut out dimension: 100mm Diameter
 Finish: Matte, Off White

Panel Thickness:
 65 to 150mm

Item code: 10160000
Unit: ea
Price: \$ _____

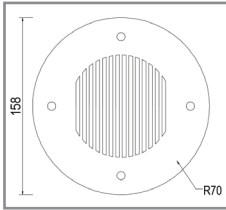

Description: Pressure Relief Port
 Temperature Range: +40° to -42°C
 Room Volume: 1 per each 125m³
 Composition: Polypropylene
 Cut out dimension: 100mm Diameter
 Finish: Matte, Off White

Panel Thickness:
 70 to 150mm

Item code: 10160001
Unit: ea
Price: \$ _____

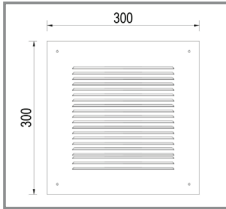

Description: Pressure Relief Port
 Temperature Range: Up to -45°C
 Room Volume: 1 per each 3000m³
 Composition: Injected moulded polycarbonate & aluminium cover plates
 Cut out dimension: 200x200mm
 Finish: Matte, Off White

Panel Thickness:
 150mm
 200mm
 250mm

Item code: 10160002
Unit: ea
Price: \$ _____

Item code: 10160003
Unit: ea
Price: \$ _____

Item code: 10160004
Unit: ea
Price: \$ _____

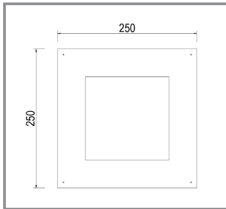
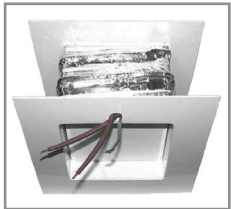

Description: Pressure Relief Port
 Temperature Range: Up to -25°C
 Room Volume: 1 per each 750m³
 Composition: PVC
 Cut out dimension: 150x150mm
 Finish: Off White

Panel Thickness:
 150mm

Item code: 10160005
Unit: ea
Price: \$ _____

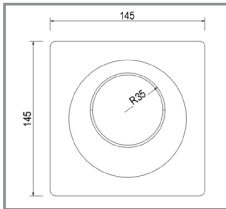

Description: JAV Pressure Relief Port
 Temperature Range: -20°C to 40°C
 Room Volume: 1 per each 40m³
 Composition: PVC
 Cut out dimension: 100mm Diameter
 Finish: Off White

Panel Thickness:
 100mm
 150mm
 200mm

Item code: 10160006
Unit: ea
Price: \$ _____

Item code: 10160007
Unit: ea
Price: \$ _____

Item code: 10160008
Unit: ea
Price: \$ _____

8 PRESSURE RELIEF PORTS

PRESSURE RELIEF PORTS CONTINUED

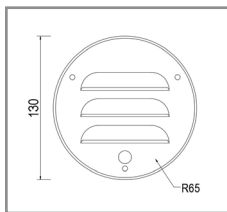

Description: Kason 1830 Pressure Relief Port
 Temperature Range: Up to -29°C
 Room Volume: approximately 1 per each 85m³
 Composition: Aluminium, Internal Sleeve - self-extinguishing Lexan
 Cut out dimension: 89mm Diameter
 Finish: Aluminium

Panel Thickness: 100mm
Item code: 10160009
Unit: ea
Price: \$_____

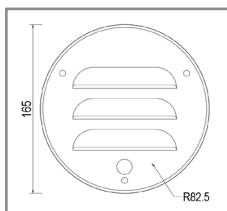

Description: Kason 1832 Pressure Relief Port
 Temperature Range: Up to -29°C
 Room Volume: approximately 1 per each 170m³
 Composition: Aluminium, Internal Sleeve - self-extinguishing Lexan
 Cut out dimension: 118mm Diameter
 Finish: Aluminium

Panel Thickness: 100mm
Item code: 10160010
Unit: ea
Price: \$_____

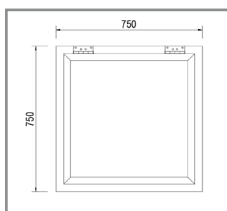



Description: Askin Pressure Relief Port
 Temperature Range:
 Room Volume:
 Composition: Hardwood frame w/heaters & C/Bond Canopy
 Cut out dimension: 600x600mm
 Finish: Panel

Panel Thickness: 100mm
Item code: 10160011
Unit: ea
Price: \$_____

9 FIXINGS

9.1 RIVETS

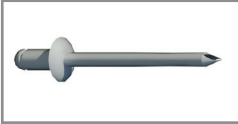
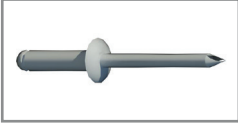
ALUMINIUM

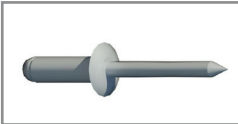
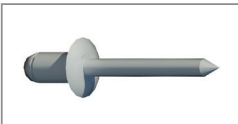
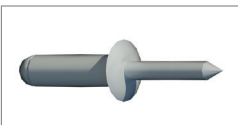
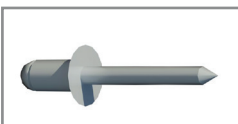
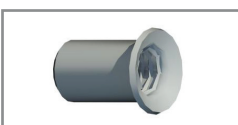
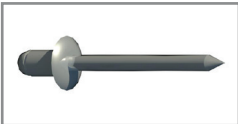
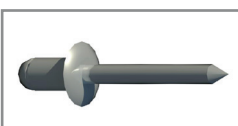
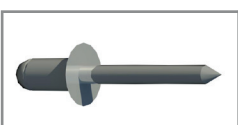
	Item code:	Description:	Finish:	Unit:	Price:
	10170001	3x6mm	Plain	ea	\$ _____
	10170000	3x6mm	Surfmist	ea	\$ _____
		3x6mm	Colour Std.	ea	\$ _____
		3x6mm	Colour Match.	ea	\$ _____
	10170101	3x12mm	Plain	ea	\$ _____
	10170100	3x12mm	Surfmist	ea	\$ _____
		3x12mm	Colour Std.	ea	\$ _____
		3x12mm	Colour Match.	ea	\$ _____
	10170301	4x6mm	Plain	ea	\$ _____
	10170300	4x6mm	Surfmist	ea	\$ _____
		4x6mm	Colour Std.	ea	\$ _____
		4x6mm	Colour Match.	ea	\$ _____
	10170401	4x14mm	Plain	ea	\$ _____
	10170400	4x14mm	Surfmist	ea	\$ _____
		4x14mm	Colour Std.	ea	\$ _____
		4x14mm	Colour Match.	ea	\$ _____
	10170601	5x8mm	Plain	ea	\$ _____
	10170600	5x8mm	Surfmist	ea	\$ _____
		5x8mm	Colour Std.	ea	\$ _____
		5x8mm	Colour Match.	ea	\$ _____
	10170801	5x16mm	Plain	ea	\$ _____
	10170800	5x16mm	Surfmist	ea	\$ _____
		5x16mm	Colour Std.	ea	\$ _____
		5x16mm	Colour Match.	ea	\$ _____
	10171001	5x8mm - Countersunk	Plain	ea	\$ _____
	10171000	5x8mm - Countersunk	Surfmist	ea	\$ _____
		5x8mm - Countersunk	Colour Std.	ea	\$ _____
		5x8mm - Countersunk	Colour Match.	ea	\$ _____
	10171699	5x8mm - Threaded Nutsert	Plain	ea	\$ _____
	10171201	4x6mm	Plain	ea	\$ _____
	10171200	4x6mm	Surfmist	ea	\$ _____
		4x6mm	Colour Std.	ea	\$ _____
		4x6mm	Colour Match.	ea	\$ _____
	10171401	5x8mm	Plain	ea	\$ _____
	10171400	5x8mm	Surfmist	ea	\$ _____
		5x8mm	Colour Std.	ea	\$ _____
		5x8mm	Colour Match.	ea	\$ _____
	10171501	5x8mm Countersunk	Plain	ea	\$ _____
	10171500	5x8mm Countersunk	Surfmist	ea	\$ _____
		5x8mm Countersunk	Colour Std.	ea	\$ _____
		5x8mm Countersunk	Colour Match.	ea	\$ _____

STAINLESS STEEL

Units of measure: ea = each; lgth = per length; mt = per meter; p/m² = per meter squared. For pricing information please refer to your local ASKIN representative.

9 FIXINGS

9.2 ROOFING SCREWS

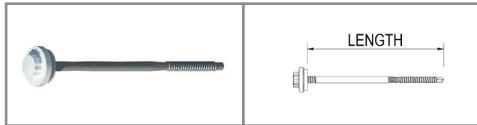

EJOT - METRIC ROOF FIXING 1.2-3.0mm STEEL

Item code:	Description:	Material:	Panel Core:	Unit:	Price:
10171700	5.5/6.3x(L)115mm	Class 4	50mm	ea	\$ _____
10171701	5.5/6.3x(L)135mm	Class 4	75mm	ea	\$ _____
10171702	5.5/6.3x(L)172mm	Class 4	100mm	ea	\$ _____
10171703	5.5/6.3x(L)192mm	Class 4	125mm	ea	\$ _____
10171704	5.5/6.3x(L)232mm	Class 4	150-175mm	ea	\$ _____
10171705	5.5/6.3x(L)262mm	Class 4	200mm	ea	\$ _____

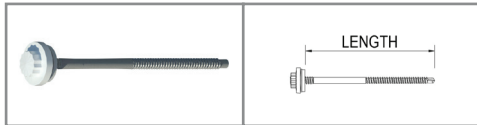

10171706	5.5/6.3x(L)107mm	S/Steel	50mm	ea	\$ _____
10171707	5.5/6.3x(L)147mm	S/Steel	75mm	ea	\$ _____
10171708	5.5/6.3x(L)167mm	S/Steel	100mm	ea	\$ _____
10171709	5.5/6.3x(L)197mm	S/Steel	125mm	ea	\$ _____
10171710	5.5/6.3x(L)237mm	S/Steel	150-175mm	ea	\$ _____
10171711	5.5/6.3x(L)267mm	S/Steel	200mm	ea	\$ _____

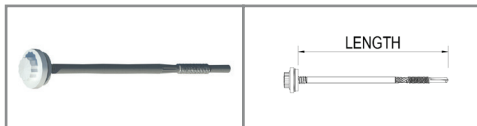

EJOT - METRIC ROOF FIXING 4-12mm STEEL

Item code:	Description:	Material:	Panel Core:	Unit:	Price:
10171712	5.5/6.3x(L)125mm	Class 4	50mm	ea	\$ _____
10171713	5.5/6.3x(L)155mm	Class 4	75mm	ea	\$ _____
10171714	5.5/6.3x(L)195mm	Class 4	100-125mm	ea	\$ _____
10171715	5.5/6.3x(L)235mm	Class 4	150mm	ea	\$ _____
10171716	5.5/6.3x(L)250mm	Class 4	175mm	ea	\$ _____
10171717	5.5/6.3x(L)275mm	Class 4	200mm	ea	\$ _____

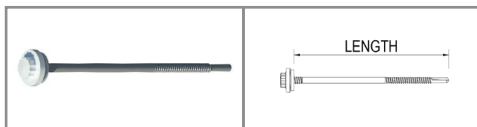

10171718	5.5/6.3x(L)135mm	S/Steel	50mm	ea	\$ _____
10171719	5.5/6.3x(L)155mm	S/Steel	75mm	ea	\$ _____
10171720	5.5/6.3x(L)175mm	S/Steel	100mm	ea	\$ _____
10171721	5.5/6.3x(L)195mm	S/Steel	125mm	ea	\$ _____
10171722	5.5/6.3x(L)245mm	S/Steel	150-175mm	ea	\$ _____
10171723	5.5/6.3x(L)300mm	S/Steel	200mm	ea	\$ _____



TEK - MAIN FIX TO LIGHT/MEDIUM STEEL 1-5mm THICK W/MULTI SEAL

Item code:	Description:	Finish:	Panel Core:	Unit:	Price:
10171750	12G 30mm	Galv.	n/a	ea	\$ _____
10171751	12G 35mm	Galv.	n/a	ea	\$ _____

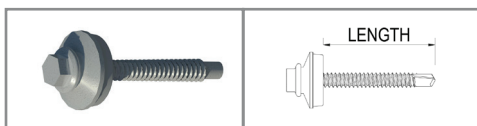

10171760	14G 50mm	Galv.	n/a	ea	\$ _____
10171770	14G 95mm	Galv.	n/a	ea	\$ _____
10171780	14G 110mm	Galv.	50mm	ea	\$ _____
10171790	14G 150mm	Galv.	75/100mm	ea	\$ _____
10171800	14G 230mm	Galv.	150mm	ea	\$ _____

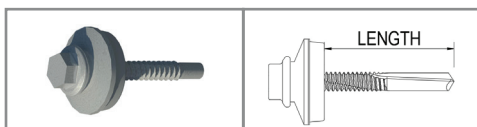

TEK - MAIN FIX TO HEAVY STEEL 3-12mm THICK W/MULTI SEAL

Item code:	Description:	Finish:	Panel Core:	Unit:	Price:
10171810	12G 38mm S500	Galv.	n/a	ea	\$ _____
10171815	12G 53mm S500	Galv.	n/a	ea	\$ _____
10171820	12G 68mm S500	Galv.	n/a	ea	\$ _____

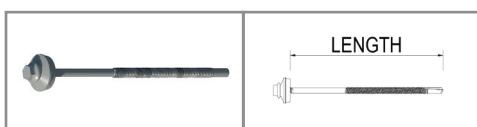

10171825	14G 150mm S500	Galv.	50/75/100mm	ea	\$ _____
10171830	14G 200mm S500	Galv.	150mm	ea	\$ _____

9 FIXINGS

9.2 ROOFING SCREWS CONTINUED

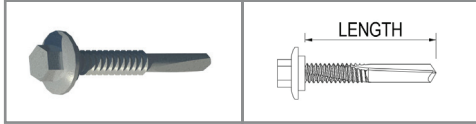

TEK - MAIN FIX TO HEAVY STEEL 3-12mm THICK W/SEAL

Item code:	Description:	Finish:	Panel Core:	Unit:	Price:
10171870	12G 38mm S500	Galv.	n/a	ea	\$ _____
10171875	12G 53mm S500	Galv.	n/a	ea	\$ _____
10171880	12G 68mm S500	Galv.	n/a	ea	\$ _____
10171885	14G 150mm S500	Galv.	50/75/100mm	ea	\$ _____
10171890	14G 200mm S500	Galv.	150mm	ea	\$ _____

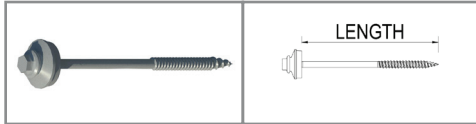
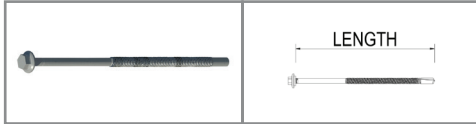

TEK - TIMBER

Item code:	Description:	Finish:	Panel Core:	Unit:	Price:
10171900	14G 115mm Type 17	Galv.	50mm	ea	\$ _____
10171905	14G 150mm Type 17	Galv.	75mm	ea	\$ _____
10171910	14G 175mm Type 17	Galv.	100mm	ea	\$ _____



STITCHING SCREW

Item code:	Description:	Finish:	Unit:	Price:
10172000	M6 25mm	Galv.	ea	\$ _____



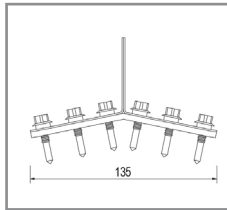
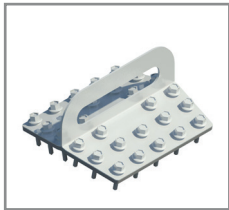

9.3 ROOF ANCHOR

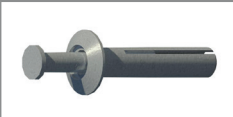
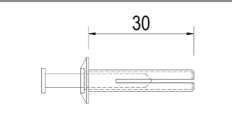

Item code:	Description:	Finish:	Unit:	Price:
10172010	RD-08 Roof Anchor W/Foam Separation Strip & Screws		ea	\$ _____

9 FIXINGS

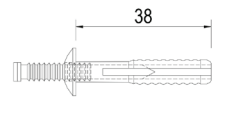
9.4 CONCRETE FASTENERS

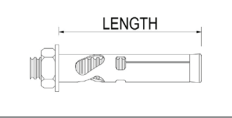
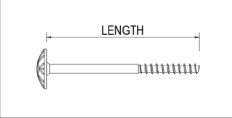
		ALUMINIUM ANCHOR				
Image	Diagram	Item code:	Description:	Finish:	Unit:	Price:
		10172020	6x30mm Tapit	Mill	ea	\$ _____
		NYLON ANCHOR				
Image	Diagram	Item code:	Description:	Finish:	Unit:	Price:
		10172026	6.5x38mm Tapit	White	ea	\$ _____
		DYNABOLT				
Image	Diagram	Item code:	Description:	Finish:	Unit:	Price:
		10172060	M6 50mm	S/Steel	ea	\$ _____
		10172070	M8 50mm	S/Steel	ea	\$ _____
		10172080	M10 50mm	S/Steel	ea	\$ _____
		10172085	M10 75mm	S/Steel	ea	\$ _____
		10172090	M10 120mm	S/Steel	ea	\$ _____
		10172105	M12 50mm	S/Steel	ea	\$ _____
		10172110	M12 60mm - Z-Yellow	S/Steel	ea	\$ _____
		10172140	M8 36mm	Zinc Plated	ea	\$ _____
		10172150	M10 90mm	Zinc Plated	ea	\$ _____
				EJOT - SOFFIT INSULATION SCREW		
Image	Diagram	Item code:	Description:	Finish:	Unit:	Price:
		10172200	100mm	S/Steel	ea	\$ _____
		10172201	125mm	S/Steel	ea	\$ _____
		10172202	150mm	S/Steel	ea	\$ _____
		10172203	175mm	S/Steel	ea	\$ _____

9.5 BOLTS, NUTS & WASHERS

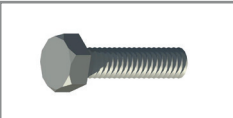
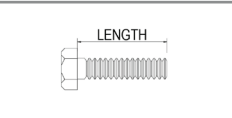
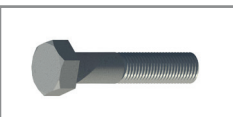
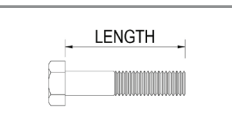
		HEX HEAD SET SCREW				
Image	Diagram	Item code:	Description:	Finish:	Unit:	Price:
		10172300	M6 25mm	Zinc Plated	ea	\$ _____
		10172400	M6 130mm	S/Steel	ea	\$ _____
		HEX HEAD BOLT				
Image	Diagram	Item code:	Description:	Finish:	Unit:	Price:
		10172500	M10 50mm	Galv.	ea	\$ _____
		10172600	M10 50mm	Zinc Plated	ea	\$ _____
		10172710	M10 30mm	S/Steel	ea	\$ _____
		10172715	M10 65mm	S/Steel	ea	\$ _____
		10172720	M10 75mm	S/Steel	ea	\$ _____
		10172725	M10 80mm	S/Steel	ea	\$ _____
		10172730	M10 90mm	S/Steel	ea	\$ _____
		10172735	M10 100mm	S/Steel	ea	\$ _____
		10172740	M10 120mm	S/Steel	ea	\$ _____
		10172745	M10 130mm	S/Steel	ea	\$ _____
		10172750	M10 140mm	S/Steel	ea	\$ _____
		10172755	M10 170mm	S/Steel	ea	\$ _____
		10172760	M10 180mm	S/Steel	ea	\$ _____
		10172765	M10 220mm	S/Steel	ea	\$ _____

9 FIXINGS

9.5 BOLTS, NUTS & WASHERS CONTINUED

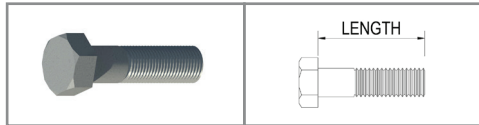

10172800

M12 45mm

Galv.

ea

\$ _____

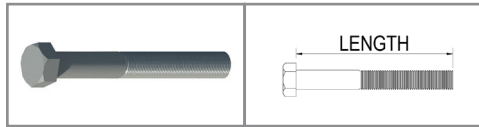

10172950

M12 140mm

S/Steel

ea

\$ _____

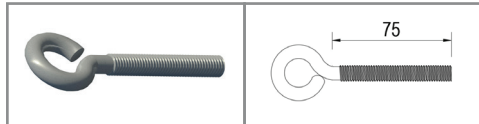

10172955

M12 170mm

S/Steel

ea

\$ _____



10173045

M16 130mm

S/Steel

ea

\$ _____



Item code:

Description:

EYE BOLT

Finish:

Unit:

Price:

10173120

M10 75mm Eye Bolt

Galv.

ea

\$ _____



10173100

M10 18mm Eye Bolt

Galv.

ea

\$ _____



10173105

M10 25-30mm Eye Bolt

Galv.

ea

\$ _____



Item code:

Description:

METAL THREAD SCREW CSK

Finish:

Unit:

Price:

10173200

MTSC 1/4 x 1-1/4 CSK

S/Steel

ea

\$ _____

10173205

MTSC 1/4 x 1-1/2 CSK

S/Steel

ea

\$ _____

10173210

MTSC 1/4 x 2-1/2 CSK

S/Steel

ea

\$ _____



Item code:

Description:

COACH BOLT

Finish:

Unit:

Price:

10173410

M10 75mm & Nut

Zinc Plated

ea

\$ _____

10173510

M10 75mm & Nut

Galv.

ea

\$ _____

10173515

M10 100mm & Nut

Galv.

ea

\$ _____

10173520

M10 120mm & Nut

Galv.

ea

\$ _____

10173525

M10 125mm & Nut

Galv.

ea

\$ _____

10173535

M10 150mm & Nut

Galv.

ea

\$ _____

10173540

M10 170mm & Nut

Galv.

ea

\$ _____

10173550

M10 200mm & Nut

Galv.

ea

\$ _____

10173555

M10 240mm & Nut

Galv.

ea

\$ _____

10173560

M10 280mm & Nut

Galv.

ea

\$ _____

10173565

M10 300mm & Nut

Galv.

ea

\$ _____

10173570

M10 350mm & Nut

Galv.

ea

\$ _____

10173575

M10 375mm & Nut

Galv.

ea

\$ _____

10173610

M10 75mm & Nut

S/Steel

ea

\$ _____

10173615

M10 100mm & Nut

S/Steel

ea

\$ _____

10173620

M10 120mm & Nut

S/Steel

ea

\$ _____

10173625

M10 125mm & Nut

S/Steel

ea

\$ _____

10173635

M10 150mm & Nut

S/Steel

ea

\$ _____

10173640

M10 170mm & Nut

S/Steel

ea

\$ _____

10173650

M10 200mm & Nut

S/Steel

ea

\$ _____

10173655

M10 240mm & Nut

S/Steel

ea

\$ _____

10173660

M10 280mm & Nut

S/Steel

ea

\$ _____

10173665

M10 300mm & Nut

S/Steel

ea

\$ _____

10173670

M10 350mm & Nut

S/Steel

ea

\$ _____

9 FIXINGS



9.5 BOLTS, NUTS & WASHERS CONTINUED

		Item code: 10173150	Description: 5/16x1.1/4"	Finish: Zinc Plated	Unit: ea	Price: \$ _____
UNBRAKO BOLT						
		Item code: 10173300	Description: M12x30mm Bolt & Nut w/washers	Finish: Galv.	Unit: ea	Price: \$ _____
PURLIN BOLT						
		Item code: 10173700	Description: Bolt Hex Head 5/16 x 1" and Nut	Finish: Zinc Plated	Unit: ea	Price: \$ _____
NUTS						
		10173800	M10	Galv.	ea	\$ _____
		10173801	M10	Zinc Plated	ea	\$ _____
		10173810	1/4 BSW	Zinc Plated	ea	\$ _____
		10173820	M12	Galv.	ea	\$ _____
		10173822	M12	S/Steel	ea	\$ _____
		10173821	M12	Zinc Plated	ea	\$ _____
		10173830	3/4"	S/Steel	ea	\$ _____
		10173831	5/16"	S/Steel	ea	\$ _____
		10173840	5/16"	Zinc Plated	ea	\$ _____
		10173841	5/32"	Zinc Plated	ea	\$ _____
		10173850	M16	Galv.	ea	\$ _____
		10173900	M8 Dome Nut	S/Steel	ea	\$ _____
		10173911	M10 Dome Nut	Galv.	ea	\$ _____
		10173901	M10 Dome Nut	S/Steel	ea	\$ _____
		10173920	3/16" Dome Nut	Zinc Plated	ea	\$ _____
		10173912	M12 Dome Nut	Galv.	ea	\$ _____
		10173902	M12 Dome Nut	S/Steel	ea	\$ _____
NUTS						
		Item code: 10173930	Description: T 1/4 BSW	Finish: Zinc Plated	Unit: ea	Price: \$ _____
		10173940	M10 Joiner	Galv.	ea	\$ _____
		10173942	M12 Joiner	Galv.	ea	\$ _____
WASHERS						
		Item code: 10174080	Description: Washer Poly Plastic Suitable for chipboard screws	Finish: Plastic	Unit: ea	Price: \$ _____

9 FIXINGS

9.5 BOLTS, NUTS & WASHERS CONTINUED

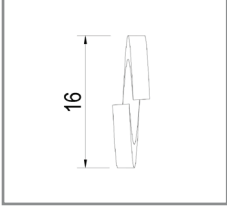
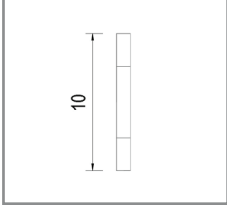
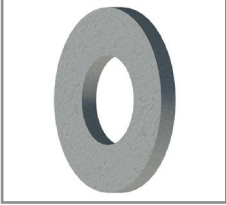
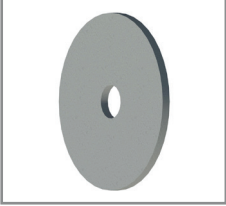
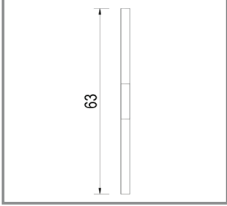
WASHERS

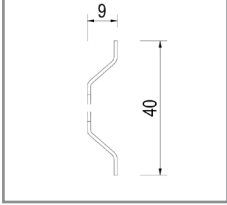
		Item code:	Description:	Finish:	Unit:	Price:
		10174055	M10 Spring 16x2.5mm	Zinc Plated	ea	\$ _____
		10174056	M12 Spring 16x2.5mm	Galv	ea	\$ _____
		10174000	M5 Flat	S/Steel	ea	\$ _____
		10174005	M10 Flat 21x1.6mm	Galv.	ea	\$ _____
		10174006	M10 Flat 21x1.6mm	Zinc Plated	ea	\$ _____
		10174010	M12 63x2.8mm	Galv.	ea	\$ _____
		10174011	M12 63x2.8mm	Zinc Plated	ea	\$ _____
		10174070	Countersunk 40mm	Zinc Plated	ea	\$ _____
		10174071	Countersunk 40mm Capping		ea	\$ _____
		10174072	Countersunk 60mm	Zinc Plated	ea	\$ _____
		10174073	Countersunk 60mm Capping		ea	\$ _____

9 FIXINGS

9.6 SCREWS

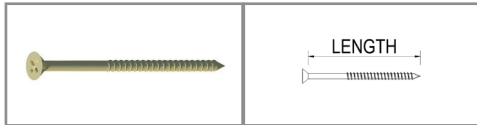

CHIPBOARD SCREW

Item code:	Dimension:	Material:	Finish:	Unit:	Price:
10174110	10-8X100mm	Zinc Plated	Yellow	ea	\$ _____
10174115	10-8X120mm	Zinc Plated	Yellow	ea	\$ _____

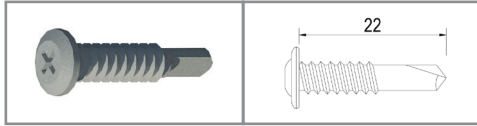

WAFER HEAD SCREW

Item code:	Dimension:	Material:	Finish:	Unit:	Price:
10174200	10-16X22mm	C3 Galv.	Mill	ea	\$ _____
10174201	10-16X22mm	C3 Galv.	Surfmist	ea	\$ _____
	10-16X22mm	C3 Galv.	Custom	ea	\$ _____

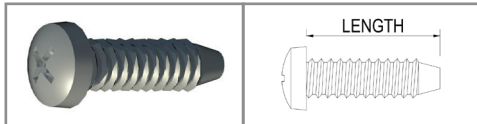

PAN HEAD SCREW

Item code:	Dimension:	Finish:	Unit:	Price:
10174210	M5 20mm	S/Steel	ea	\$ _____
10174250	6G x 3/4"	S/Steel	ea	\$ _____
10174260	8G x 1"	S/Steel	ea	\$ _____
10174261	8G x 1-1/2"	S/Steel	ea	\$ _____
10174271	12G x 1-1/2"	S/Steel	ea	\$ _____
10174270	12G x 1"	S/Steel	ea	\$ _____

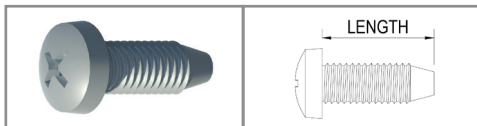

10174262	8G x 1"	Zinc Plated	ea	\$ _____
10174272	12G x 1"	Zinc Plated	ea	\$ _____
10174273	12G x 1-1/2"	Zinc Plated	ea	\$ _____

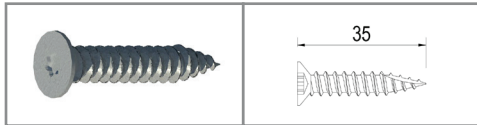

SELF-DRILLING, SELF-TAPPING SCREW

Item code:	Description:	Material:	Unit:	Price:
10174300	6.5x35mm	S/Steel	ea	\$ _____

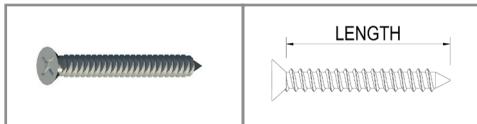

COUNTERSUNK HEAD SCREW

Item code:	Dimension:	Finish:	Unit:	Price:
10174400	6G x 3/4"	S/Steel	ea	\$ _____
10174410	1/4" BSW x 1-1/4"	S/Steel	ea	\$ _____
10174411	1/4" BSW x 1- 1/2"	S/Steel	ea	\$ _____
10174413	1/4" BSW x 2-1/2"	S/Steel	ea	\$ _____
10174420	M8 20mm	S/Steel	ea	\$ _____
10174450	10G x 1-1/2"	S/Steel	ea	\$ _____
10174460	12G x 2"	S/Steel	ea	\$ _____

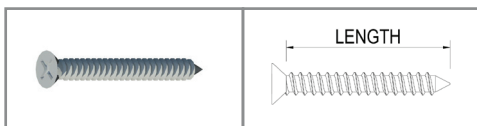

COUNTERSUNK HEAD SCREW

Item code:	Dimension:	Material:	Finish:	Unit:	Price:
10174435	6G x 3/4"		Zinc Plated	ea	\$ _____
10174445	8G x 1"		Zinc Plated	ea	\$ _____
10174462	12G x 1"		Zinc Plated	ea	\$ _____
10174463	12G x 1-1/2"		Zinc Plated	ea	\$ _____

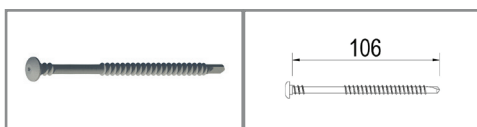

TORX SCREW

Item code:	Dimension:	Finish:	Unit:	Price:
10174480	106mm		ea	\$ _____

9 FIXINGS

9.7 DRILL BITS & BLADES

DRILL BITS

Item code:	Dimension:	Finish:	Unit:	Price:
10174492	52x3mm (#30)	S/Steel	ea	\$ _____
10174491	52x4mm (#20)	S/Steel	ea	\$ _____
10174490	53x5mm (#11)	S/Steel	ea	\$ _____

PANEL SAW BLADES

Item code:	Description:	Finish:	Unit:	Price:
10174500	Panel Saw Blade 16mm Bore		ea	\$ _____
10174501	Panel Saw Blade 25mm Bore		ea	\$ _____
10174502	Thumper Blade		ea	\$ _____
10174503	Silent Saw Blade		ea	\$ _____
10174504	Diamond Saw Blade		ea	\$ _____

10 ADHESIVES & PAINTS

10.1 EXPANDABLE FOAMS



Item code:	Description:	Unit:	Price:
10180000	750ml Fisher Gun Foam	ea	\$ _____
10180001	500ml Cleaner	ea	\$ _____
10180002	750ml Trigger Foam	ea	\$ _____
10180003	500ml Gun Cleaner NSW	ea	\$ _____
10180004	750ml illbruck FM330 NSW	ea	\$ _____
10180005	Foam Gun	ea	\$ _____

10.2 SEALANTS



COOL ROOM MASTIC

Item code:	Description:	Colour:	Unit:	Price:
10180050	410g Mastic CTG	Off White	ea	\$ _____
10180051	450g 5612 Mastic CTG WA	Off White	ea	\$ _____

SILICONE SEALANTS

Item code:	Description:	Colour:	Unit:	Price:
10180400	300ml Adhesive CTG		ea	\$ _____
10180102	Silicone CTG	Paperbark	ea	\$ _____
10180103	Silicone CTG	Stone	ea	\$ _____
10180100	Silicone CTG	White	ea	\$ _____
10180101	Silicone CTG	Clear	ea	\$ _____
10180104	300g Wet Area Silicone CTG WA	White	ea	\$ _____
10180105	300g Wet Area Silicone CTG WA	Clear	ea	\$ _____
10180106	300g Bostik Sanitary 6S NSW	Clear	ea	\$ _____
10180107	310g Selleys Roof & Gutter NSW	Grey	ea	\$ _____
10180108	300ml Join Leader Joinsil 820 NSW	Off White	ea	\$ _____



POLYURETHANE SEALANTS

Item code:	Description:	Colour:	Unit:	Price:
10180200	310ml Pro CTG	Grey	ea	\$ _____
10180201	310ml Pro CTG	White	ea	\$ _____
10180202	600ml Pro SSG	White	ea	\$ _____
10180203	300ml 11FC CTG	White	ea	\$ _____
10180204	600ml 11FC SSG	White	ea	\$ _____
10180205	600ml 221 SSG	White	ea	\$ _____
10180206	380g Bostik Seal n' Flex CTG NSW	Grey	ea	\$ _____
10180207	600ml Bostik Seal n' Flex SSG	Grey	ea	\$ _____



FIRE RATED SEALANTS

Item code:	Description:	Colour:	Unit:	Price:
10180300	310ml Sika Firerate CTG	Grey	ea	\$ _____
10180301	15PK Sika Firerate SSG	Grey	ea	\$ _____
10180302	600ml FOSROC Flamex One SSG	Grey	ea	\$ _____

10 ADHESIVES & PAINTS

10.2 SEALANTS CONTINUED



ADHESIVE SEALANTS

Item code:	Description:	Colour:	Unit:	Price:
10180401	310ml Probond Foaming Adhesive	White	ea	\$ _____
10180402	320ml Liquid Nails		ea	\$ _____



SEALANT GUN

Item code:	Description:	Unit:	Price:
10180450	Sausage Gun	ea	\$ _____

10.3 TAPES & PAINT



PACKING TAPES

Item code:	Description:	Colour:	Unit:	Price:
10180500	48mm Clear Packing Tape	Clear	ea	\$ _____
10180501	48mm x 30m Duct Tape	Grey	ea	\$ _____

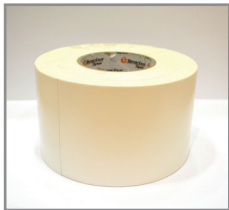

10180502	K190WH100/50	White	ea	\$ _____
10180504	Strapping Tape	Black	ea	\$ _____
10180503	Aluminium Foil		ea	\$ _____



PAINT

Item code:	Description:	Colour:	Unit:	Price:
10180600	Touch Up Paint	Surfmist	ea	\$ _____
10180601	Touch Up Paint	Paperbark	ea	\$ _____
10180650	Touch Up Paint	Cold Galv.	ea	\$ _____
10180602	Touch Up Paint	Precious Silver	ea	\$ _____
10180603	Touch Up Paint	Dune	ea	\$ _____
10180604	Touch Up Paint	Bushland	ea	\$ _____
10180605	Touch Up Paint	Classic Cream	ea	\$ _____
10180606	Touch Up Paint	Pale Eucalypt	ea	\$ _____

10.4 VAPOUR BARRIERS

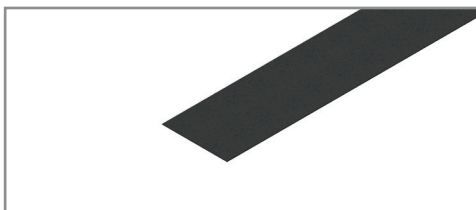

Item code:	Description:	Colour:	Unit:	Price:
10180700	Bitumen Roof Seal 50mm	Black	ea	\$ _____
10180701	Bitumen Roof Seal 75mm	Black	ea	\$ _____
10180702	Bitumen Roof Seal 100mm	Black	ea	\$ _____

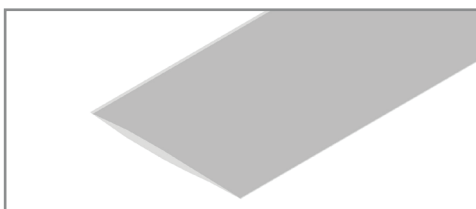

10180730	250Um Polytube Clear	Clear	mt	\$ _____
----------	----------------------	-------	----	----------



FREE CALL 13000 ASKIN
Email: contact@askin.net.au
www.askin.net.au

ASKIN GROUP

150 Albert Road
South Melbourne, VIC, 3205
Phone: +61 3 8769 4816
Email: contact@askin.net.au

WESTERN AUSTRALIA

1 Denninup Way
Malaga, WA, 6090
Phone: +61 8 9249 4022
Email: wa@askin.net.au

QUEENSLAND

129 Cobalt Street
Carole Park, QLD 4300
Phone: +61 7 3718 9500
Email: qld@askin.net.au

VICTORIA & TASMANIA

270 - 280 Hammond Road
Dandenong South, VIC, 3175
Phone: +61 3 8769 4888
Email: vic@askin.net.au

SA & NT

162a Philip Hwy
Elizabeth South, SA, 5112
Phone: +61 8 8252 7188
Email: sa@askin.net.au

NSW & ACT

100 Peter Brock Drive
Eastern Creek, NSW, 2766
Phone: +61 2 8825 2598
Email: nsw@askin.net.au