



DURACOM™
WALL CLADDING SYSTEM



InnovaTM's stunning range of wall claddings, lining and flooring products will move you to reassess your concept of excellence in wall claddings and flooring systems. Durable and dynamic, fresh and contemporary, InnovaTM is already turning industry heads. Now let the InnovaTM range of cladding and flooring products breathe new life into your creativity and project specification.

Contents	8 // Sheet Sizes and Weight
	8 // Production Information
	8 // Thermal Breaks
	8 // Fire Resistance
	8 // Thermal Conductivity
	8 // Weather Resistance
	8 // Moisture Management
	9 // Insulation
	9 // Handling and Storage
	9 // Health and Safety
	9 // Cutting and Drilling
	10 // Accessories
	11 // Design Considerations
	11 // Control Joints
	11 // Panel Preparation
	12 // Wind Load
	13-27 // Installation Details
	28 // Painting and Decorating
	28-29 // Bushfire and Boundary Wall Areas
	30 // Warranty
30 // Terms and Conditions	

DURACOM™ WALL CLADDING SYSTEM

With its smooth, flat surface and square-edge finish, Duracom™ wall cladding system is ideal for the exterior cladding of low to medium-rise buildings. Utilising our trusted fibre cement-coated compressed sheeting, Duracom™ delivers a strikingly modern, durable finish.

Lightweight yet exceptionally resilient, Duracom™ wall cladding system is perfect for expressed jointing and a variety of finishes – from painted to textured coatings.

Duracom™ Wall Cladding System

- / Is lightweight and highly durable
- / Weather-Resistant – Simply shrugs off water damage
- / Compliant with AS4284 weatherability requirements
- / Fully sealed, balanced panels that won't rot, burn or corrode
- / Allows easy decoration in a range of design finishes
- / Rapid installation
- / Complies with BAL-40 as required in AS3959 – Construction of buildings in bushfire-prone areas

Specify Duracom™ with confidence

innovafibrement.com.au/fire-acoustic/fire-resistant-systems

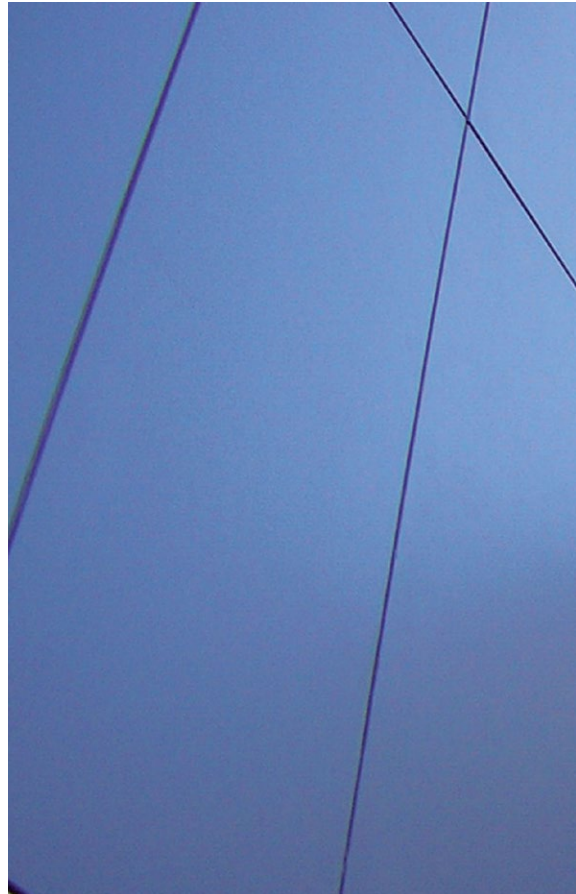



Innova™ deemed to comply external wall cladding systems.

- / Compressed fibre cement range
- / Architectural designed weatherboard range
- / Grooved and profiled cladding range

Innova™'s products have superior fire performance against four key indices.



Ignition index = 0

Fibre cement does not ignite



Spread of flame index = 0

There is no spread of fire with fibre cement



Heat evolved index = 0

Heat does not evolve from fibre cement



Smoke developed index = 0-1

Smoke is not emitted from fibre cement



Up to **BAL-40**
as per AS3959



Tested in Australia by accredited Australian authorities **CSIRO** and **Exova Warrington**

Case Study 01.

Commercial

We supplied a variety of fibre cement products to the new extension of the Westfield Carousel Shopping Centre. Duracom™ was used by Denmac, who were contracted to install the external cladding. Duralux™ was also used as soffit lining, which was installed by EXZO. The products allowed both Denmac and EXZO to achieve a robust finish without sacrificing design objectives.



Project: Westfield Shopping Centre
Location: Carousel, Western Australia
Architect: Scentre Group
Contractor: Denmac
Products used: Duracom™ / Duralux™

Technical brochure
August 2024

“Duracom™ is backed by a well established company which means the product is always available when we need it, which minimised site laydown.”

Rob Innocent
Denmac

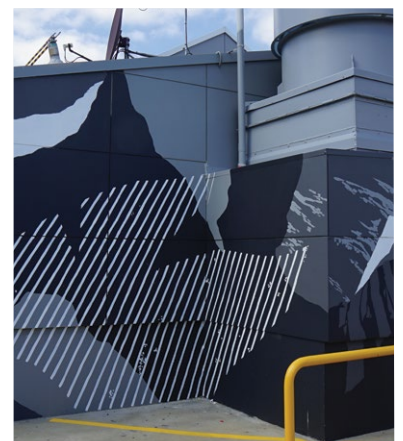
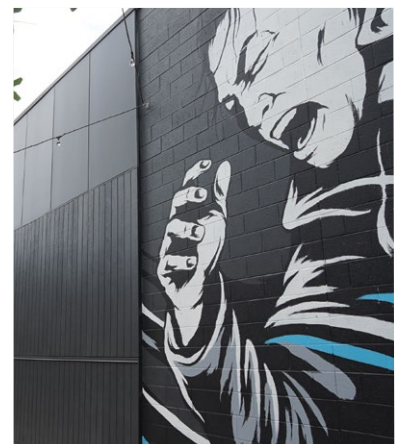

DURACOM™

WALL CLADDING SYSTEM

Product Description

Duracom™ Wall Cladding System, utilising fibre cement compressed panels and Cold Formed Section (CFS) steel support framing, is a strong and durable wall cladding system.

Duracom™ panels fixed to CFS steel support framing are ideally suited for versatile architectural wall claddings and parapet applications in industrial, institutional, commercial and multi-storey residential buildings.

Duracom™ panels are designed for installation in a variety of patterns, including vertical, horizontal, brick-bond or diamond inclined.

Duracom™ panels are available in 9mm and 12mm thicknesses and are finished with site applied acrylic paint system.

Advantages

- / Lightweight cladding system.
- / Readily accepts many forms of decorative finish.
- / Highly durable product.
- / Dynamic architectural style.
- / Fully sealed and balanced panels.

Sheet Sizes and Weight - Table 1

Duracom™ panels are available in the following sizes.						
THICKNESS mm	WEIGHT* kg/m ²	WIDTH mm	LENGTH mm			
			1800	2400	2700	3000
9	14.6	900	✓	✓		
		1200	✓	✓	✓	✓
12	19.5	1200		✓		✓

Tolerances

Duracom™ is manufactured to the requirements of AS 2908.2.

Product Information

Duracom™ panels are a compressed, autoclaved, cellulose fibre reinforced silica/cement panel, specially formulated and prepared to meet the requirements for use in exterior applications.

Duracom™ panels have a smooth flat surface and a neat square edged finish, for enhanced expressed joint wall claddings.

Our fibre cement products are manufactured to the Australian / New Zealand Standard AS/NZS 2908.2-2000 Cellulose-Cement Products, Part 2: Flat sheets and Duracom™ is classified as Type A-Category 3.

Thermal Breaks

The Duracom™ wall cladding system is attached to the outside face of a metal framed wall where it is separated from the metal frame by Duracom™ Steel Top Hats (off-stud) orientated vertically.

Where the lightweight external cladding is not fixed to the metal frame, the NCC thermal break requirements are negated therefore no Thermal Break is required when using the Duracom™ wall cladding system.

Fire Resistance

Duracom™ has been tested for and passed the Early Fire Hazard Property criteria in compliance with AS/NZS 1530.3 and AS/NZS 3837 and is deemed a Group 1 Material in accordance with the National Construction Code NCC Volume 1 specification C2D11 Fire Hazard Properties. AS/NZS 1530.3; Early Fire Hazard Properties.

/ Ignition Index	0
/ Spread of Flame Index	0
/ Heat Evolved Index	0
/ Smoke Developed Index	0-1

Duracom™ is deemed as non-combustible and may be used where a non-combustible material is required.

Thermal Conductivity

At Equilibrium Moisture Content the approximate thermal conductivity of Duracom is: - 0.507 W/mK.

Weather Resistance

Duracom™ conforms to the National Construction Code (NCC) requirements for external wall applications.

Duracom™ Wall Cladding System has been tested to AS/NZS 4284 Testing of Building Facades.

Duracom™ subject to freeze/thaw conditions must be painted. Duracom™ should not be used in situations where it will be in direct contact with snow or ice for prolonged periods.

Moisture Management

Designers, specifiers and builders have a duty of care to identify moisture associated risks with any individual building design.

Wall construction design should consider both the interior and exterior environments of the building to effectively manage moisture. Special consideration should be given to buildings that are in extreme climates or at higher risk of wind-driven rain.

In addition, all wall openings, penetrations, junctions, connections, window heads, sills and jambs must incorporate appropriate flashing for waterproofing. All other components, materials and installation methods used to manage moisture in walls should comply with the relevant standards of the National Construction Code (NCC).

For applications with AS/NZS 1170.2 Wind Pressures up to SLS +0.82kPa & -1.23kPa, (e.g. AS 4055 N4 & C2), an AS/NZS 4200.1 compliant Water Control Membrane shall be used. For higher AS/NZS 1170.2 Wind Pressures up to SLS +/- 2.5kPa Innova Durabarrier™ shall be used.

Durability

Duracom™ physical properties make it a very durable product.

- / Duracom™ panels are immune to permanent water damage in both short and long-term exposure.
- / Duracom™ panels will not rot or burn and are unaffected by termites, air, steam, salt and sunlight.
- / Duracom™ panels are not adversely affected over a temperature range of 0°C to 95°C.

Vapour Permeable Moisture Barrier

A vapour permeable moisture barrier must be installed in accordance with the AS 4200.2 – 'Pliable building membranes and underlays – Installation and the vapour permeable moisture barrier manufacturers' guidelines.

The vapour permeable moisture barrier shall comply with AS/NZS 4200.1 and have the following properties:

- / Vapour barrier – low or medium
- / Water barrier – high

A vapour permeable moisture barrier is used to prevent moisture ingress by acting as a drainage plane while enabling water vapour build up from inside the frame to escape.

Flashing

It is a requirement of the NCC to install flashings to all penetrations which includes but not limited to windows, doors, meter boxes, intersections etc.

Insulation

Duracom™ Wall Cladding System will typically require insulation to be installed to meet NCC Energy Efficiency requirements. Insulation should be installed in accordance with the manufacturer's instructions. Insulation batt must fit snugly between framing members to minimise heat loss.

Cutting and Drilling

Duracom™ can be cut to size on site. Power tools used for cutting, drilling or sanding must be fitted with appropriate dust collection devices or alternatively an approved (P1 or P2) dust mask and safety glasses should be worn. It is recommended that work always be carried out in a well-ventilated location.

The most suitable cutting methods are:

- / **DURABLADE**
180mm Diameter.
This unique cutting blade is ideal for cutting fibre cement and can be fitted to a 185mm circular saw, i.e. Makita or similar. Please ensure safe working practices when using.

/ DRILLING

Use normal high-speed masonry drill bits. Do not use the drill's hammer function. For small round holes, the use of a hole-saw is recommended. For small rectangular or circular penetrations, drill a series of small holes around the perimeter of the cut-out. Tap out the waste piece from the sheet face while supporting the underside of the opening to avoid damage. Clean rough edges with a rasp.

Large rectangular openings are formed by deeply scoring the perimeter of the opening. Next, form a hole in the centre of the opening (refer method above) then saw cut from the hole to the corners of the opening. Snap out the four triangular segments. Clean rough edges with a rasp.

Cutting Around Openings

When cutting sheets around window or door openings, a 5mm nominal clearance must be provided at the jamb, head and sill. Under a window, keep as near to a full sheet width as practical.

Sheet courses should be set out so that as near to a full sheet width as possible remains under a window, or similar openings.

Flashing and mouldings must be installed as appropriate to prevent ingress of water.

Handling and Storage

Duracom™ must be stacked flat, up off the ground and supported on equally spaced (max 400mm) level gluts.

Sheeting must be kept dry. When stored outdoors it must be protected from the weather.

Care should be taken to avoid damage to the ends, edges and surfaces.

Sheets must be dry prior to fixing or finishing.

Health and Safety

Duracom™ is manufactured from cellulose fibre, finely ground silica, Portland cement and additives. As manufactured, the product will not release airborne dust, but during drilling, cutting and sanding operations cellulose fibres, silica and calcium silicate dust may be released.

Breathing in fine silica dust is hazardous and prolonged exposure (usually over several years) may cause bronchitis, silicosis or cancer.

Avoid Inhaling Dust

When cutting sheets, work in a well-ventilated area and use the methods recommended in this literature to minimise dust generation. If using power tools wear an approved (P1 or P2) dust mask and safety glasses.

These precautions are not necessary when stacking, unloading or handling fibre cement products.

For further information or a Material Safety Data Sheet contact the nearest Sales Office or go to innovafibreceement.com.au

Coastal Areas





The durability of galvanised fasteners used for exterior cladding in coastal or similar corrosive environments can be as low as 10 years.

For this reason, we recommend the use of Stainless Steel fasteners within 1km of the coast or other large expanses of salt water.

DURACOM™

WALL CLADDING SYSTEM

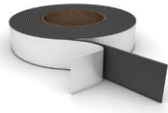
Accessories

PRIMARY TOP HAT GALVANISED STEEL	120 x 35 x 0.75BMT - 6000mm	PRODUCT CODE 847	
	120 x 35 x 1.15BMT - 6000mm	PRODUCT CODE 831	
INTERMEDIATE TOP HAT GALVANISED STEEL	50 x 35 x 0.75BMT - 6000mm	PRODUCT CODE 849	
	50 x 35 x 1.15BMT - 6000mm	PRODUCT CODE 835	
HORIZONTAL BACKING STRIP BMT 0.42	1190mm	PRODUCT CODE 839	
	2390mm	PRODUCT CODE 841	
	2990mm	PRODUCT CODE 843	
EPDM FOAM GASKET	25m	PRODUCT CODE 845	
WEATHER SEAL WASHER		PRODUCT CODE DCA-WSEAL	
WAFER HEAD SELF-DRILLING SCREW. (Recommended for exposed fixing)	No.10 x 30mm	PRODUCT CODE GSA-SCREW 3010	

Fasteners - Supplied by others

Duracom™ to Top Hats (Concealed Fixing)

no.10 x 30mm Countersunk Self Drilling Screw



Duracom™ to Top Hats (Exposed Fixing)

no.10 x 30mm Pan Head Self Drilling Screw



no.10 x 30mm Wafer Head Self Drilling Screw



Top Hats to Primary Frame

Class 3 Hex Head Screw, 12-14 x 20mm



/ Fasteners must comply with AS 3566, with a minimum Class 3 coating.

FILLING/FINISHING OF FASTENERS

/ Countersunk screw holes must be filled with an epoxy filler such as Megapoxy PI, and then with Exterior Topcoat. Allow at least 24hours to dry. Sand flush.

Design Considerations

It is recommended that project specific wall cladding designs be undertaken by a consultant experienced in such detailing.

The design engineer should determine the wind pressure for the project and specify the layout, spacing and fixing of the top hats to the structure.

The deflection of the supporting structure should be limited span/250 for Serviceability Wind Load, or as limited by AS/NZS1170.2.

In all areas, care should be taken in the design detailing, especially around all openings, corners and other junctions, to ensure weather resistance of the total system.

Before the Duracom™ panels and the supporting substructure are installed and fixed, particular care should be taken that all flashing and waterproofing work is complete, including all vapour permeable building wraps and damp proof coursing.

Control Joints

In many cases, control joints will not be required as typical expressed joints permit some differential movement of the Duracom™ panels and the sub-framing.

It is recommended that the designer consider the need for control joints in the following cases:

- / Where the wall cladding crosses a building control joint.
- / Where there is likelihood of movement in the sub-framing.
- / Continuous wall cladding greater than eight (8) metres in length.
- / At a change in the structural substrate; e.g. masonry to steel framing.

Panel Preparation

For in situ paint finish applications, Duracom™ panels are supplied sealed with a proprietary sealer applied during manufacture for durability.

Installation

Prior to Top Hat and sheet installation, dress all wall openings including penetrations, connections and intersections, window heads, sills and jambs ensuring appropriate air barriers and flashing tapes and mechanical flashings are installed correctly as per AS4200.2 – ‘Pliable building membranes and underlays Installation’, and the details contained in this technical brochure.

Top Hat Spans for Wind Load/Pressure Load

The Top Hat capacities have been calculated in accordance with AS/NZS4600 – cold form steel structures.

It is the responsibility of the Project Engineer to specify the connection of Top Hats to the support structure.

For example minimum 12g screw on each leg of Top Hat i.e. two 12g screws at each crossing of Top Hat & Frame, and minimum steel frame specification 1.5mm bmt and G450 material.

Table 2 - Duracom Top Hat 0.75BMT - Span and Fastener Spacing Table

Wind Classification AS4055	Max. Design Ultimate Limit State Wind Pressure AS/NZS 1170.2		Primary / Intermediate Maximum Top Hat Span (mm)	Within 1200mm of corners (mm)		General Areas of Walls (Away from Corners) (mm)	
	Within 1200mm of corners - kPa	General areas of walls - kPa		Max. Top Hat Spacing (mm)	Fastener Spacing	Max. Top Hat Spacing (mm)	Fastener Spacing
N1	-0.94	-0.53, +0.62	1250 ⁽¹³⁾	600	600	600	600
N2	-1.3	-0.74, +0.86	1135 ⁽¹³⁾	600	600	600	600
N3	-2.42	-1.16, +1.35	920 ⁽¹³⁾	600	360	600	600
N4	-2.9	-1.45, +1.56	853 ⁽¹³⁾	600	310	600	600
N5	-4.27	-2.14, +2.30	900 ⁽¹⁴⁾	300	140	450	180
N6	-5.77	-2.88, +3.11	850 ⁽¹⁴⁾	300	100	450	135
C1	-1.95	-0.98, +1.05	900 ⁽¹⁴⁾	450	200	450	200
C2	-2.9	-1.45, +1.56	900 ⁽¹⁴⁾	450	140	450	200
C3	-4.27	-2.14, +2.30	900 ⁽¹⁴⁾	300	140	450	180
C4	-5.77	-2.88, +3.11	850 ⁽¹⁴⁾	300	100	450	135

NOTES:

- For Weatherproofing in N1, N2, N3, N4, C1, C2, use either AS/NZS 4200.1 vapour permeable moisture barrier; or Durabarrier Rigid Air Barrier System.
- For Weatherproofing in N5, N6, C3, C4, use Durabarrier Rigid Air Barrier System.
- All fixing lengths shall be increased by 6mm when used in conjunction with Durabarrier Rigid Air Barrier System.
- All supporting structure must be designed to resist forces from out-of-plane wind pressures.
- Cladding fixings into top hats shall be, 10G-18x30mm Fibre Tekes, min. 40mm from sheet edges & 80mm from sheet corners.
- All cladding fixings shall be pre-drilled and countersunk with Countersinking Tool.
- It is the project engineer's responsibility to specify the connection of top-hats to the supporting structure.
- Steel Framing for N1-N3 shall be min. 0.75mm BMT G550, with top hat fixings 10-16 Hex Head Tekes.
- Steel Framing for N4-N6 & C1-C4 shall be min. 1.0mm BMT G550, with top hat fixings 12-14 Hex Head Tekes.
- In N1 to N4 top hats may be supported on 2 framing members (single-span).
- In N5 to C4 top hats shall be supported on a minimum of 3 framing members (double-span).
- Primary top hats in all wind loads shall be 120x35x0.75BMT, G300.
- Intermediate top hats in N1 to N4 (up to 2.9kPa design non-cyclonic wind pressure) shall be 50x35x0.75BMT, G300.
- Intermediate top hat in N5 to C4 (up to 5.77kPa design cyclonic wind pressure) shall be 70x35x0.75BMT, G300.

Table 3 - Duracom Top Hat 1.15BMT - Span and Fastener Spacing Table

Wind Classification AS4055	Max. Design Ultimate Limit State Wind Pressure AS/NZS 1170.2		Primary / Intermediate Maximum Top Hat Span (mm)	Within 1200mm of corners (mm)		General Areas of Walls (Away from Corners) (mm)	
	Within 1200mm of corners - kPa	General areas of walls - kPa		Max. Top Hat Spacing (mm)	Fastener Spacing	Max. Top Hat Spacing (mm)	Fastener Spacing
N1	-0.94	-0.53, +0.62	1470	600	600	600	600
N2	-1.3	-0.74, +0.86	1368	600	600	600	600
N3	-2.42	-1.16, +1.35	1141	600	500	600	600
N4	-2.9	-1.45, +1.56	1172	450	450	600	600
N5	-4.27	-2.14, +2.30	919	450	250	450	450
N6	-5.77	-2.88, +3.11	680	450	250	450	450
C1	-1.95	-0.98, +1.05	900	450	250	450	250
C2	-2.9	-1.45, +1.56	900	450	250	450	250
C3	-4.27	-2.14, +2.30	900	450	250	450	250
C4	-5.77	-2.88, +3.11	680	450	250	450	250

NOTES:

- For Weatherproofing in N1, N2, N3, N4, C1, C2, use either AS/NZS 4200.1 vapour permeable moisture barrier; or Durabarrier Rigid Air Barrier System.
- For Weatherproofing in N5, N6, C3, C4, use Durabarrier Rigid Air Barrier System.
- All fixing lengths shall be increased by 6mm when used in conjunction with Durabarrier Rigid Air Barrier System.
- All supporting structure must be designed to resist forces from out-of-plane wind pressures.
- Cladding fixings into top hats shall be, 10G-18x30mm Fibre Tekes, min. 40mm from sheet edges & 80mm from sheet corners.
- All cladding fixings shall be pre-drilled and countersunk with Countersinking Tool.
- It is the project engineer's responsibility to specify the connection of top-hats to the supporting structure.
- Steel Framing for N1-N3 shall be min. 0.75mm BMT G550, with top hat fixings 10-16 Hex Head Tekes.
- Steel Framing for N4-N6 & C1-C4 shall be min. 1.5mm BMT G450, with top hat fixings 12-14 Hex Head Tekes.
- In N1 to N3 top hats may be supported on 2 framing members (single-span).
- In N4 to C4 top hats shall be supported on a minimum of 3 framing members (double-span).
- Primary top hats in all wind loads shall be 120x35x1.15BMT, G300.
- Intermediate top hats in N1 to C4 shall be 50x35x1.15BMT, G300.

Installation Details

Position the Top Hats according to the predetermined and marked spacings and ensure that they are vertical (check with a spirit level).

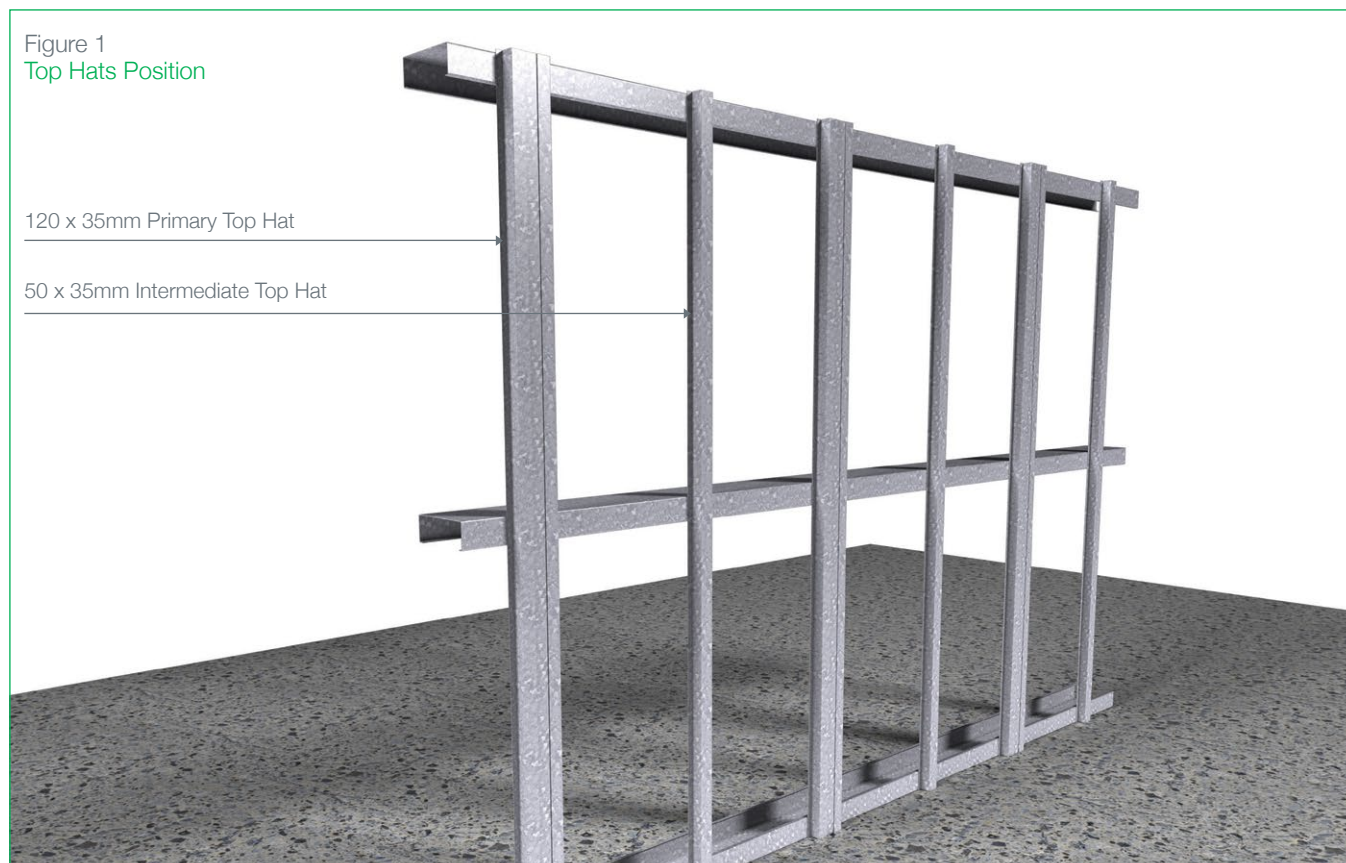

Fix the Top Hats to the steel frame using Hex Head Self-Drilling Screw fasteners ensuring that both legs of the Top Hats are fixed to the structural framing.

Also, ensure that the Top Hats are mounted vertically using a spirit level to check.

For inclined or diamond patterns, check that the inclined angle of the Top Hats are correct.

The Top Hats must be fixed on both legs to minimise flexing of the Top Hats.

Installation Details

Apply the EPDM Foam Gasket to the primary 120mm Top Hat. The seal can be applied to the mounted Top Hat in situ or it can be applied to the Top Hat before it is fixed to the steel frame.

Ensure that the EPDM Foam Gasket is applied to the centre of the purpose designed Primary 120mm Top Hat.

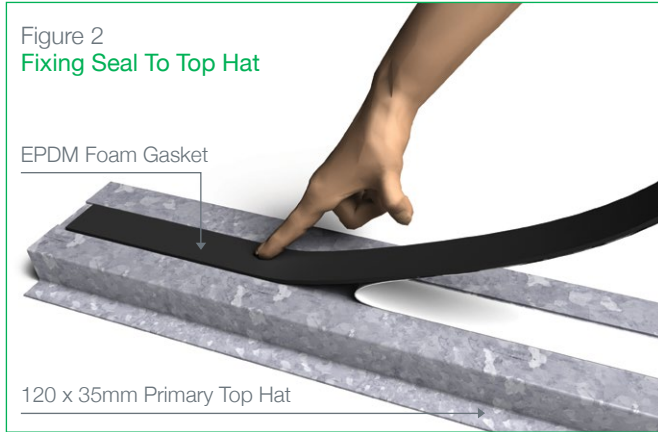
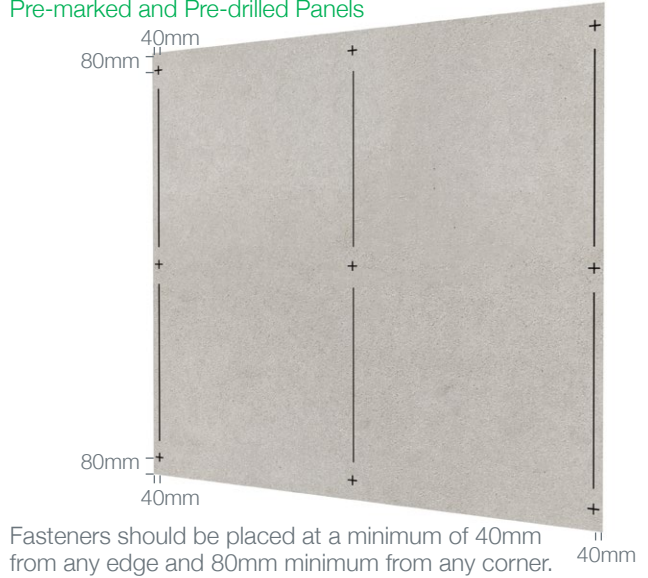

Figure 4
Pre-marked and Pre-drilled Panels



Set out, **pre-drill** and countersink the holes in the panels to be mounted, as set out in the table hereunder.

Screw holes must be pre-drilled, allowing 1mm clearance over the diameter of the screw.

Holes must be drilled using a masonry drill bit.

Do not use an impact drill.

Where screws are to be countersunk, depth must be controlled by gauge to restrict head depth to 1.5mm maximum.

Where the screws are to be exposed install the Duracom™ Weather Seal into the predrilled hole in the panel. Drive the screw through the Weather Seal and into the Top Hat using a drill driver. We recommend the use of a drill driver with torque control to prevent overdriving of screws.

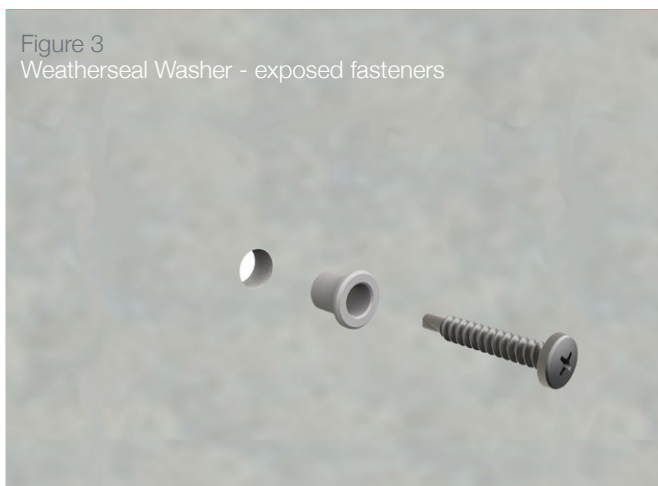

*Components not supplied

Backing Strip Installation & Sealing

At the horizontal joints between the Duracom™ panels, the Horizontal Backing Strip must be bonded to the back of the Duracom™ panel to form a socket to which the Duracom™ panels above are fixed over.

Set the backing strip 3-5mm from the edge of the Duracom™ panel. Seal the cut edge with Edge Sealer.

The backing strip can be fixed using:

- / Sikaflex 11FC. **Ensure that the sealant has cured fully before panel installation**
- / 3M 12.7mm VHB4991 or 3M VHB4941 double sided tape. The contact surfaces to be cleaned with 3M HIPA 300 Adhesive cleaner

NOTE: Sikaflex 11FC is the preferred option for fixing the backing strip.

NOTE: Ensure the sealant fills the void in the back of the Horizontal Backing Strip to prevent moisture ingress.

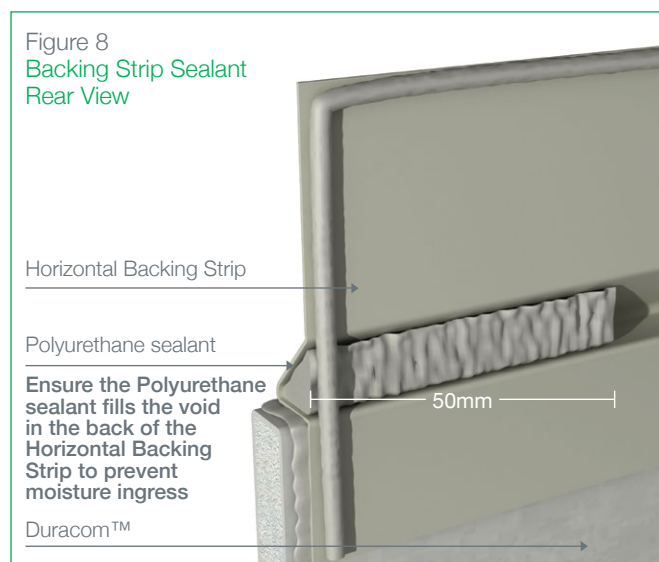
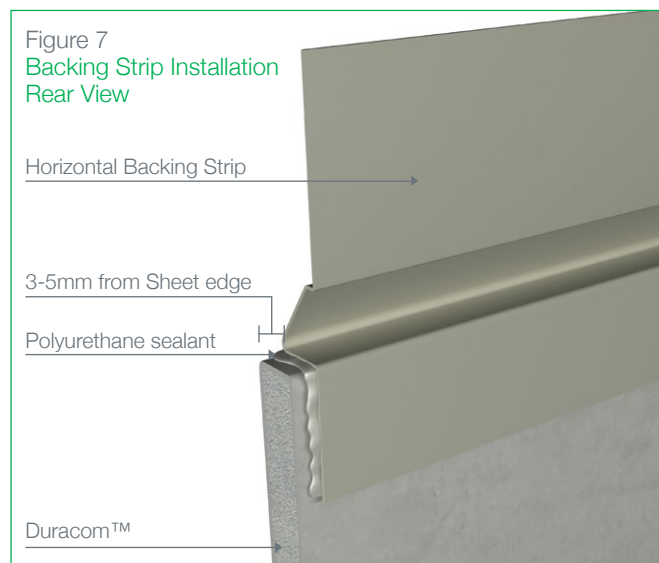
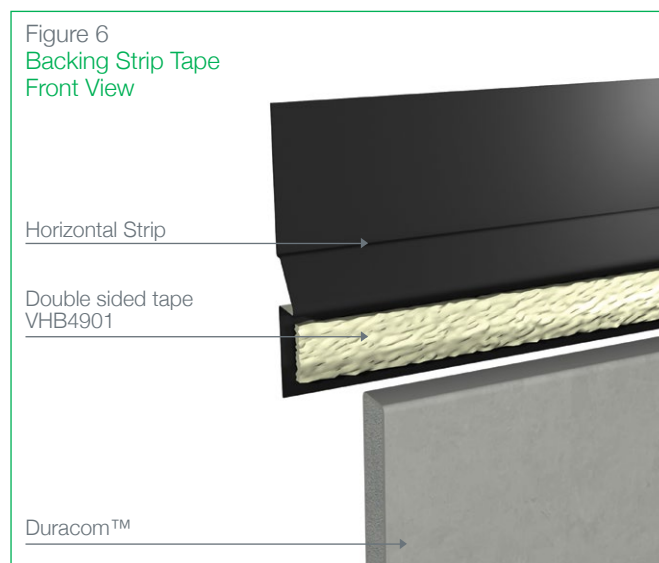
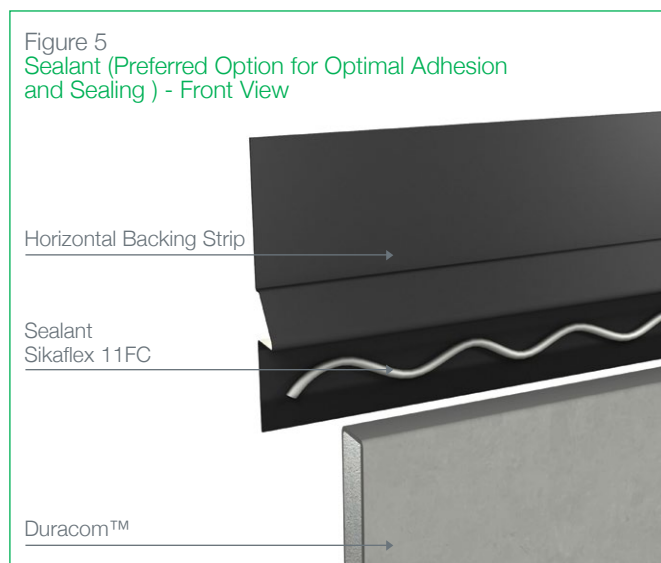

Installation Details

Figure 9
Fixing Details

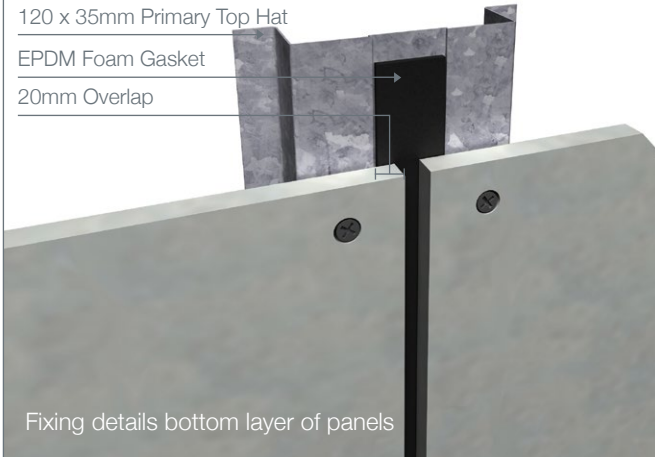

Use the backing strip to space the vertical joint of successive boards ensuring a uniform 10mm space between successive boards.

Figure 10
Vertical Spacing

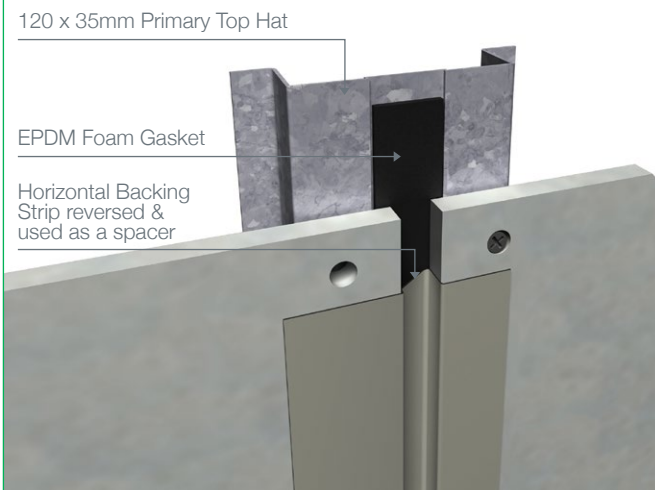

Insert the backing strip behind the top of the board. Leave fasteners loose, along the top edge of the panels to facilitate insertion of the backing strip.

Figure 11
Inserting Horizontal Backing Strip along the top edge of the panels

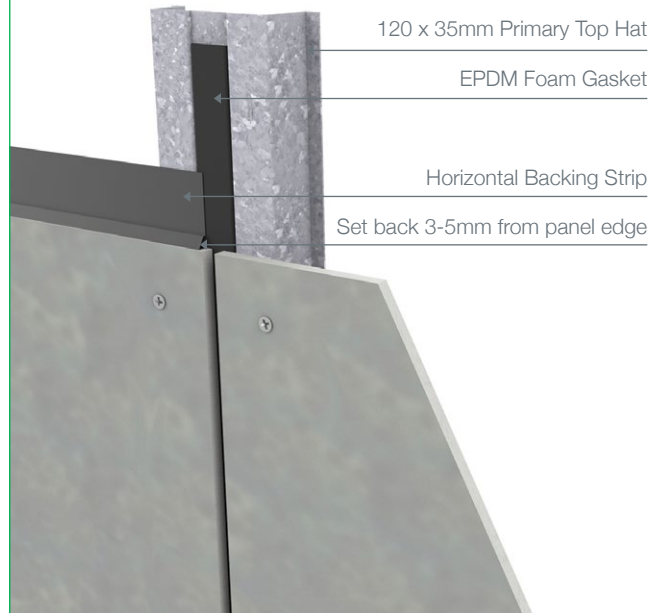

Installation Details

Installation of the next layer of board – Apply a bead of the polyurethane sealant to the top of the backing strip and then rest a pre-drilled panel on the top of the horizontal backing strip.

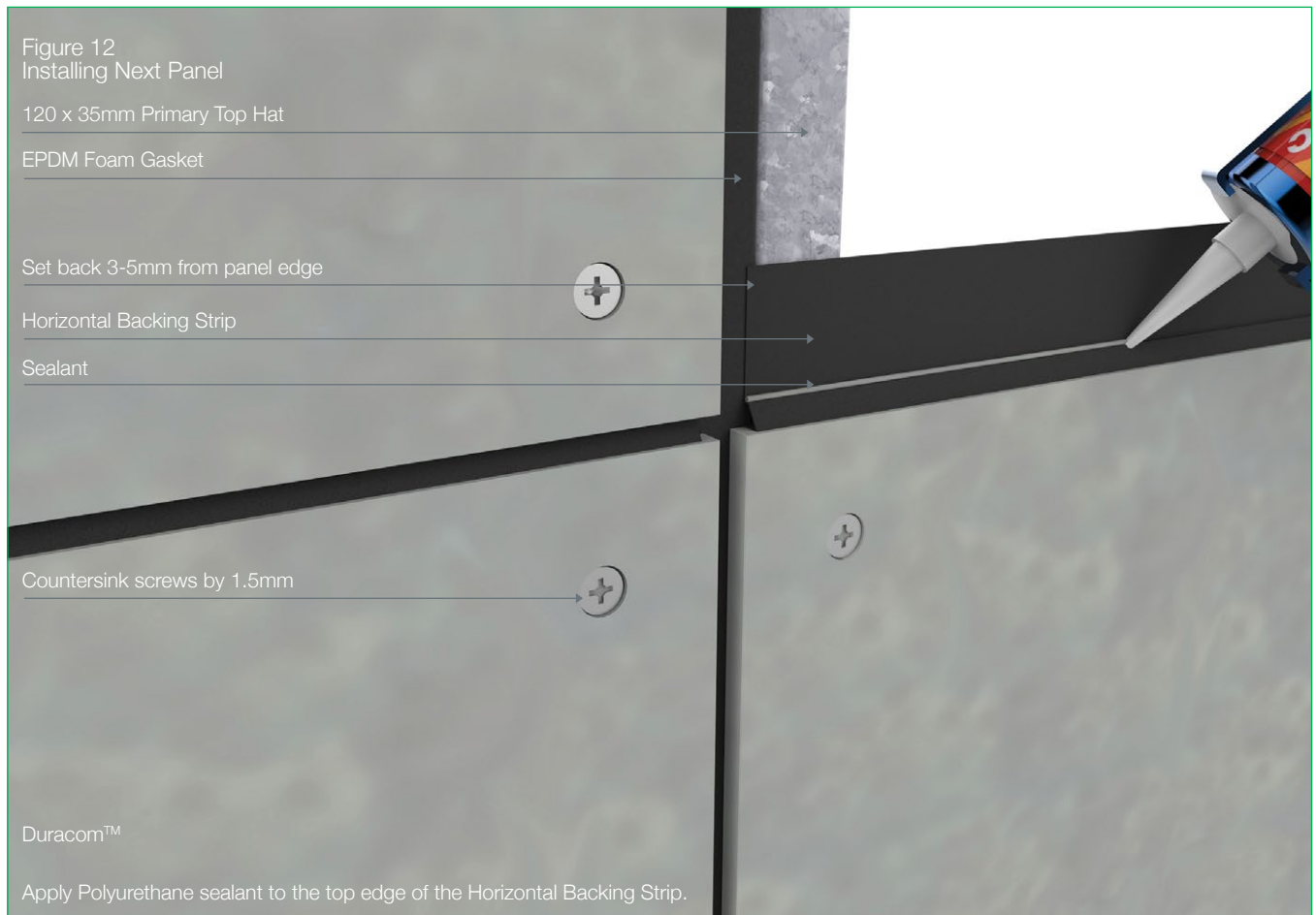

Installation Details

The architectural intent and details of buildings vary, and the full variety of wall cladding details would be impossible to catalogue.

The following details are intended to assist the designer to achieve a high-quality weather resistant Duracom™ wall cladding system. The designer should not digress from the specification set out in this manual.

Figure 13
Slab Edge

Vapour Permeable Moisture Barrier*

Foot Flashing
0.55 BMT 150 x 30 x 30*

35mm Intermediate Top Hat

Flashing Tape*

Primary Frame (steel/timber)*

Damp Proof Course*

Continuous bead of
Polyurethane sealant

Duracom™

6mm gap to allow ventilation
and drainage

6mm

NOTE: To achieve any BAL Rating, the gap to allow ventilation must be screened by mesh or perforated with maximum allowable aperture size of 2mm.

Installation Details

Figure 14
Soffit/ Wall Junction

Primary Frame (steel/timber)*
 Vapour Permeable Moisture Barrier*
 35mm Intermediate Top Hat
 Duracom™

Flashing Tape*
 Primary Frame (steel/timber)*
 Flashing*
 6mm gap to allow ventilation and drainage

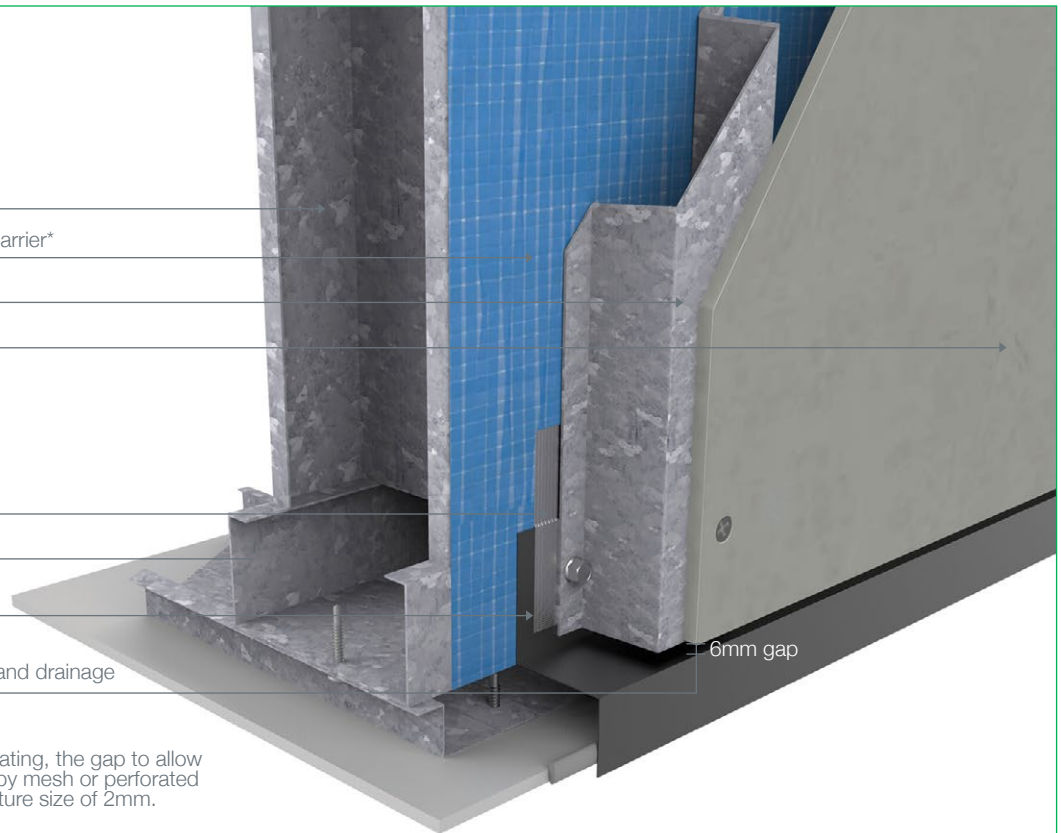

NOTE: To achieve any BAL Rating, the gap to allow ventilation must be screened by mesh or perforated with maximum allowable aperture size of 2mm.

Figure 15
Deflection Head

Concrete Floor Slab
 Support Angle*
 Closure Angle*
 Sealant*
 Flashing Tape*

Vapour Permeable Moisture Barrier*
 35mm Intermediate Top Hat
 Duracom™
 Primary Frame (steel/timber)*

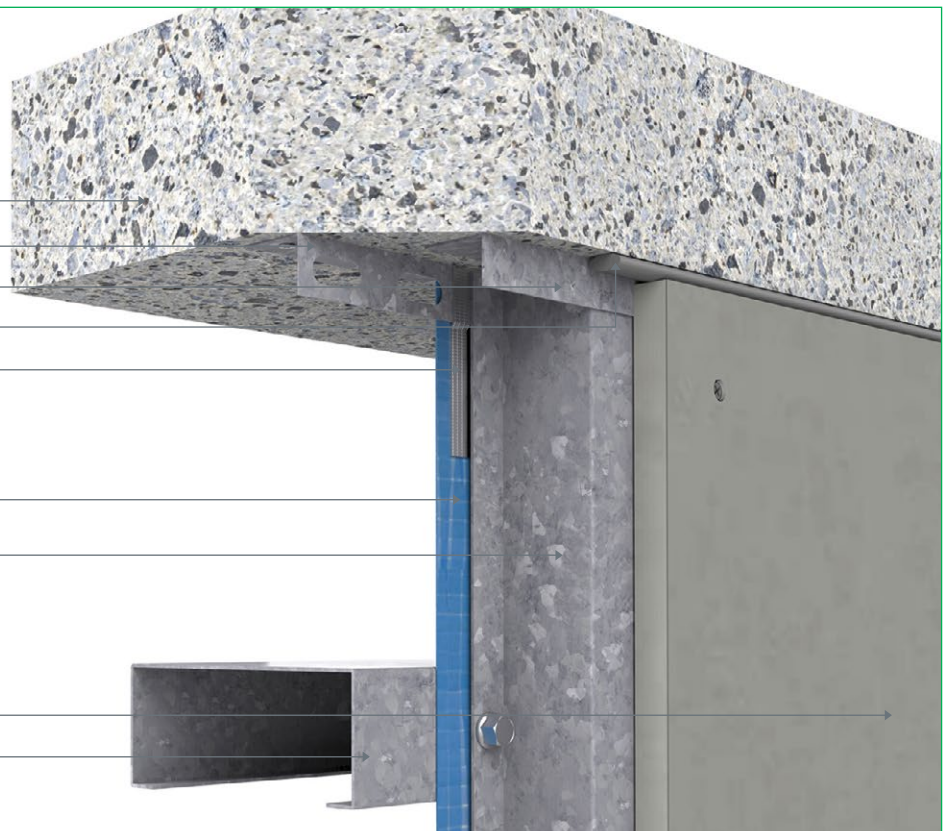

Installation Details

Figure 16
Square External Corner

10mm Gap

Continuous bead of sealant

Support Angle 60 x 60 x 0.55 BMT*

Duracom™

35mm Intermediate Top Hat

Vapour Permeable Moisture Barrier*

Primary Frame
(steel/timber)*

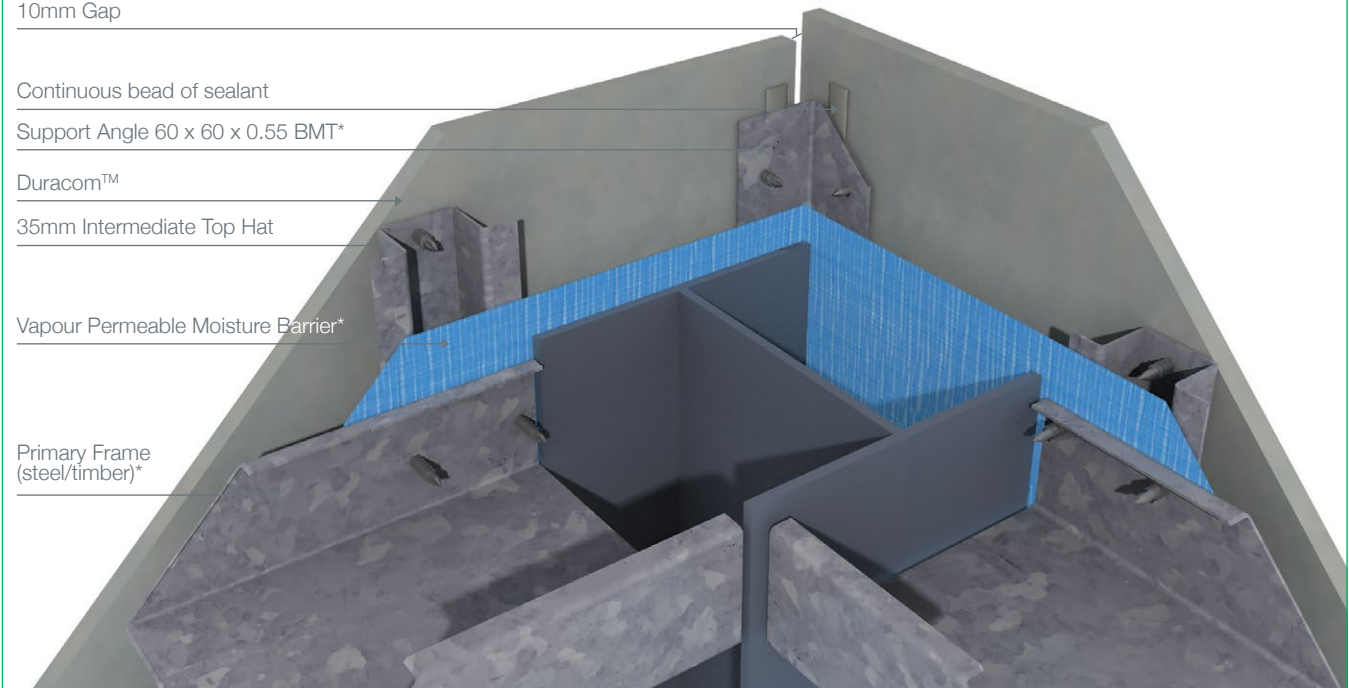

Figure 17
Square Internal Corner

Duracom™

35mm Intermediate Top Hat

Support Angle 60 x 60 x 0.55 BMT*

Vapour Permeable Moisture Barrier*

Continuous bead of Polyurethane sealant

Primary Frame
(steel/timber)*

10mm gap

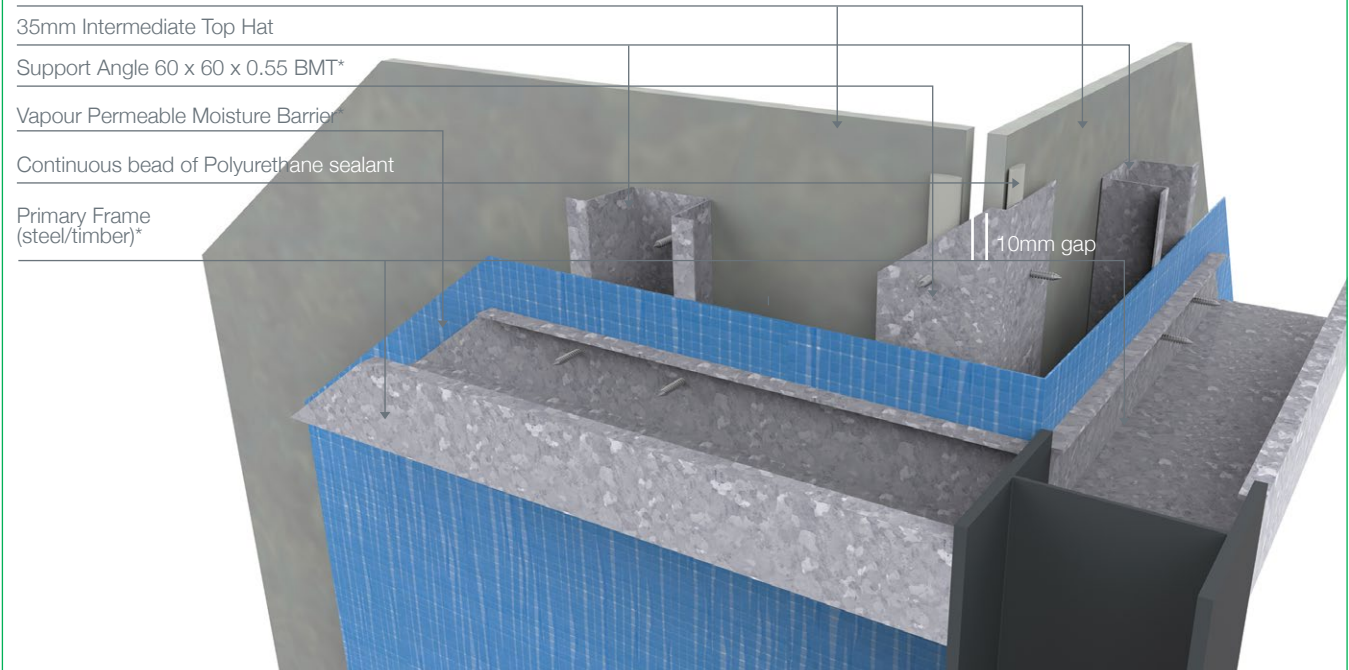

Installation Details

Figure 18
Obtuse External Corner

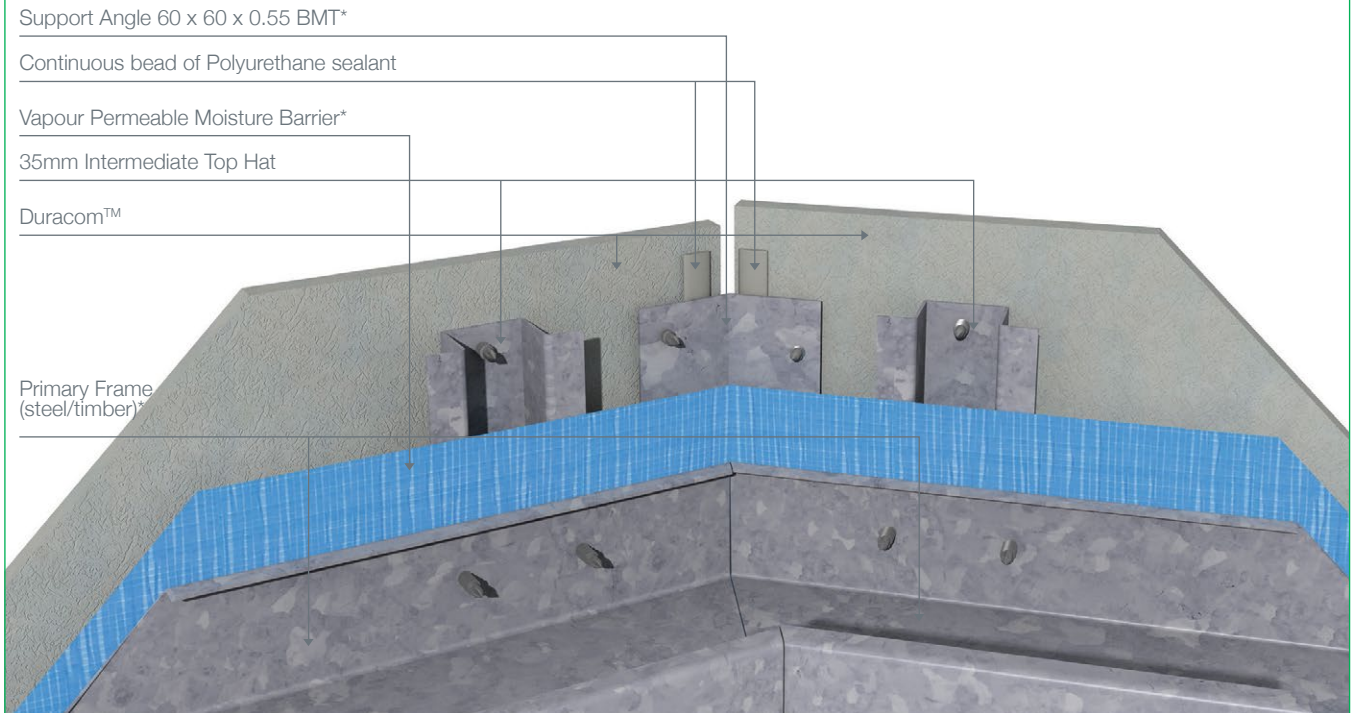
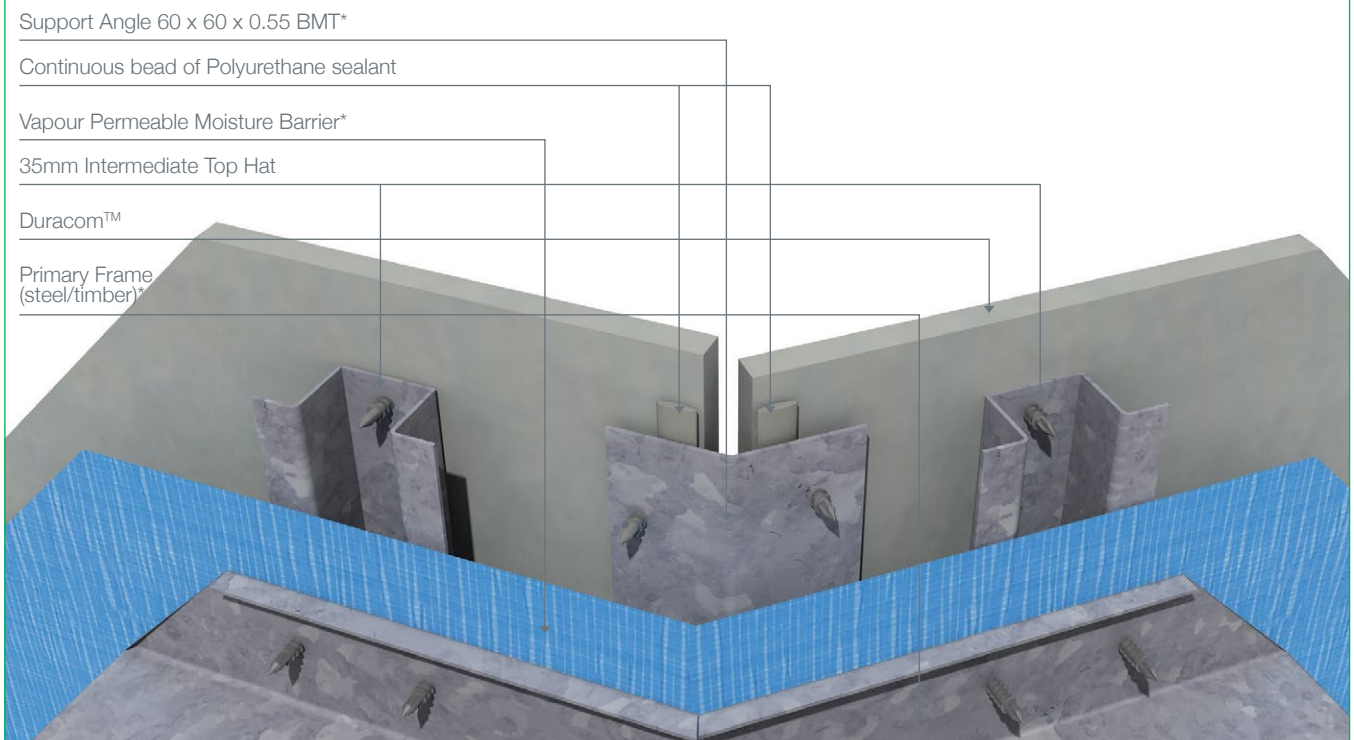

Figure 19
Obtuse Internal Corner



Installation Details - Penetrations, Openings, Windows and Doors

There are numerous varieties of penetrations, openings, windows and door treatments available. Each weather proofing detail will be dependent on the material, style and manufacturer's specifications.

Adequate weatherproofing of the opening application must be considered by the building designer in conjunction with the penetration, window and door manufacturer. The diagrams below are a guide only and the designer should consult with the appropriate manufacturers for the detail design to ensure adequate weatherproofing.

Figure 20
Window Head

- 35mm Intermediate Top Hat
- Duracom™
- Vapour Permeable Moisture Barrier*
- Flashing Tape*
- Air Seal*
- Window Head Flashing* taped into Vapour Permeable Moisture Barrier*
- 6mm gap to allow ventilation and drainage
- Primary Frame (steel/timber)*

NOTE: Vapour Permeable Moisture Barrier to extend past the Air Seal of the rear of the frame, then secured to the frame using Flashing Tape.

NOTE: To achieve any BAL Rating, the gap to allow ventilation must be screened by mesh or perforated with maximum allowable aperture size of 2mm.

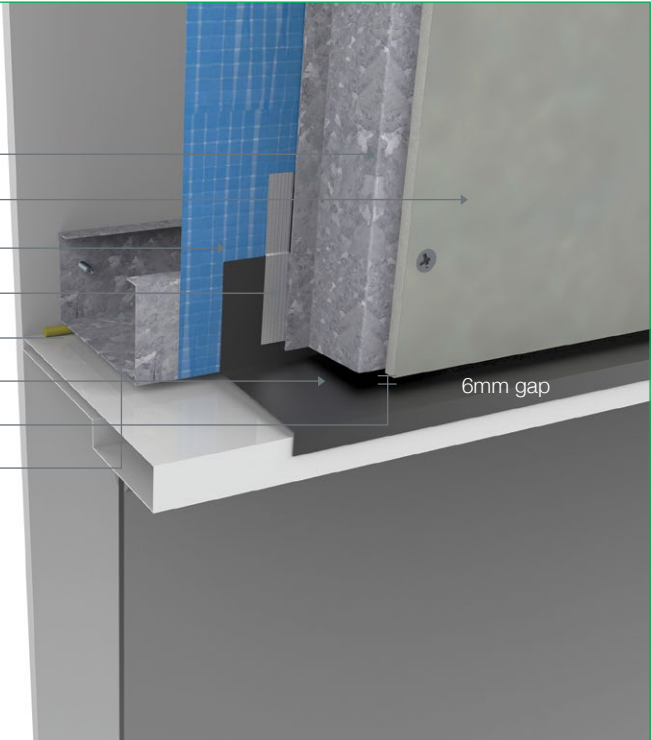
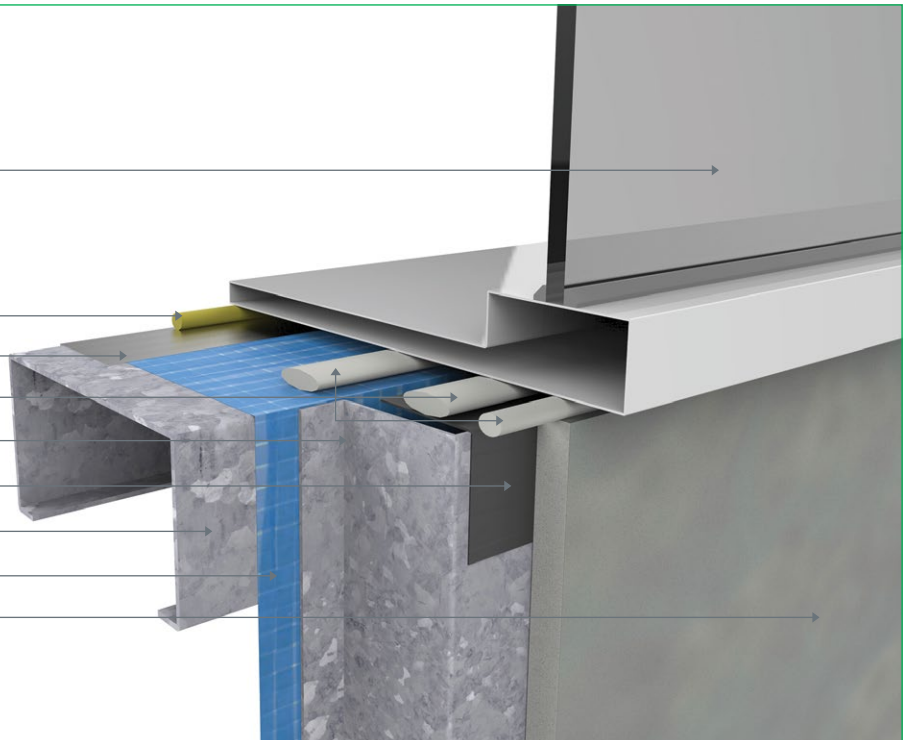
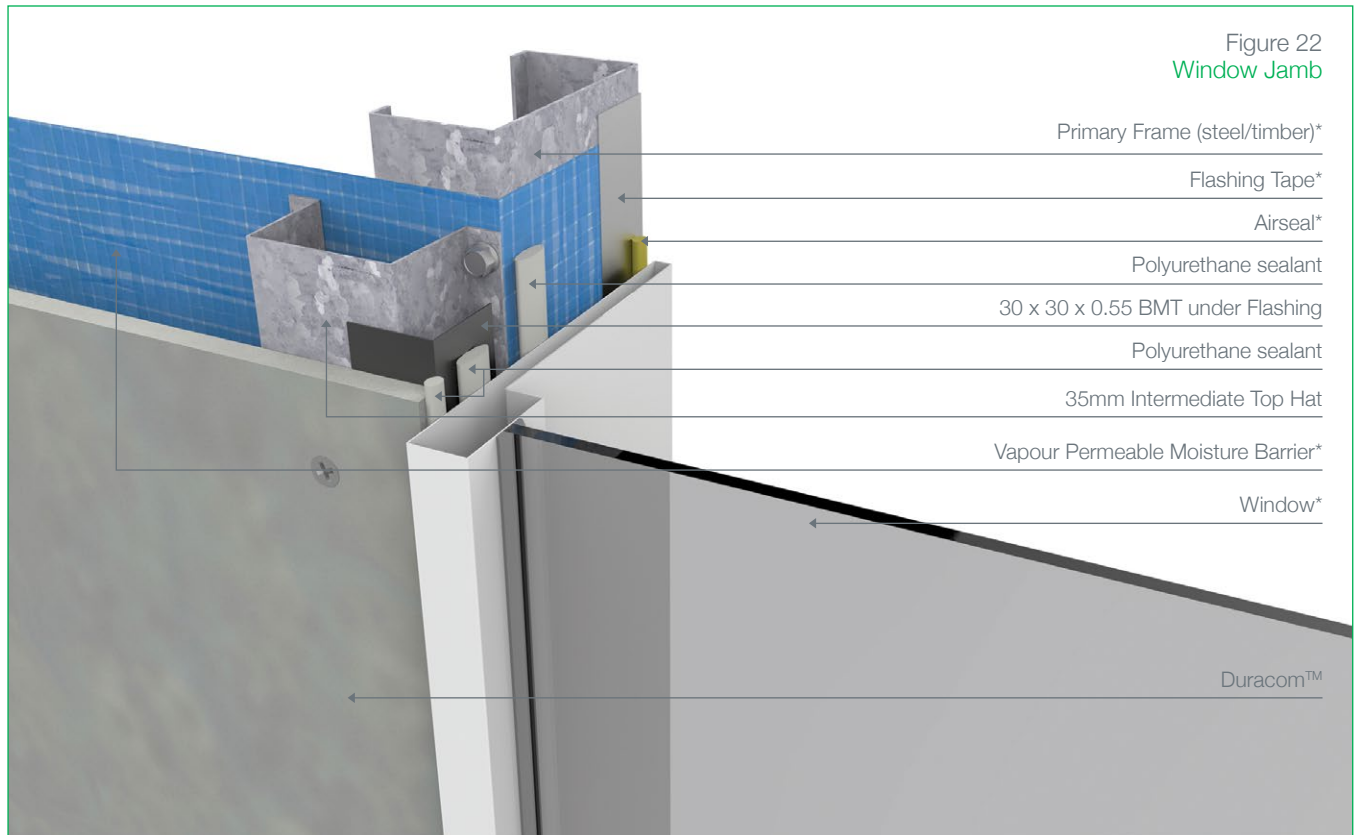

Figure 21
Window Sill Detail

- Window*
- Air Seal*
- Flashing Tape*
- Polyurethane sealant*
- 35mm Intermediate Top Hat
- 30 x 30 x 0.55 BMT under flashing
- Primary Frame (steel/timber)*
- Vapour Permeable Moisture Barrier*
- Duracom™



Installation Details - Penetrations, Openings, Windows and Doors



Installation Details - Control Joint Details

Vertical and horizontal control joints are required to match existing structural control joints and should pass through the wall cladding.

The Duracom™ wall cladding system utilises a flat galvanised 0.75 BMT steel strip.

This strip bridges the Top Hats on each side of the control joint and is riveted to one side only.

Sealant is applied between the strip and the Duracom™ panel creating a floating weather resistant seal that allows for joint expansion and contraction.

Figure 23
Vertical Construction Control Joint - Wall Abutment

- Flashing Tape*
- 35mm Intermediate Top Hat
- Continuous bead of Polyurethane sealant
- 30 x 30 x 0.55mm BMT Flashing* fitted to existing structure
- Primary Frame (steel/timber)*
- Vapour Permeable Moisture Barrier*
- Duracom™

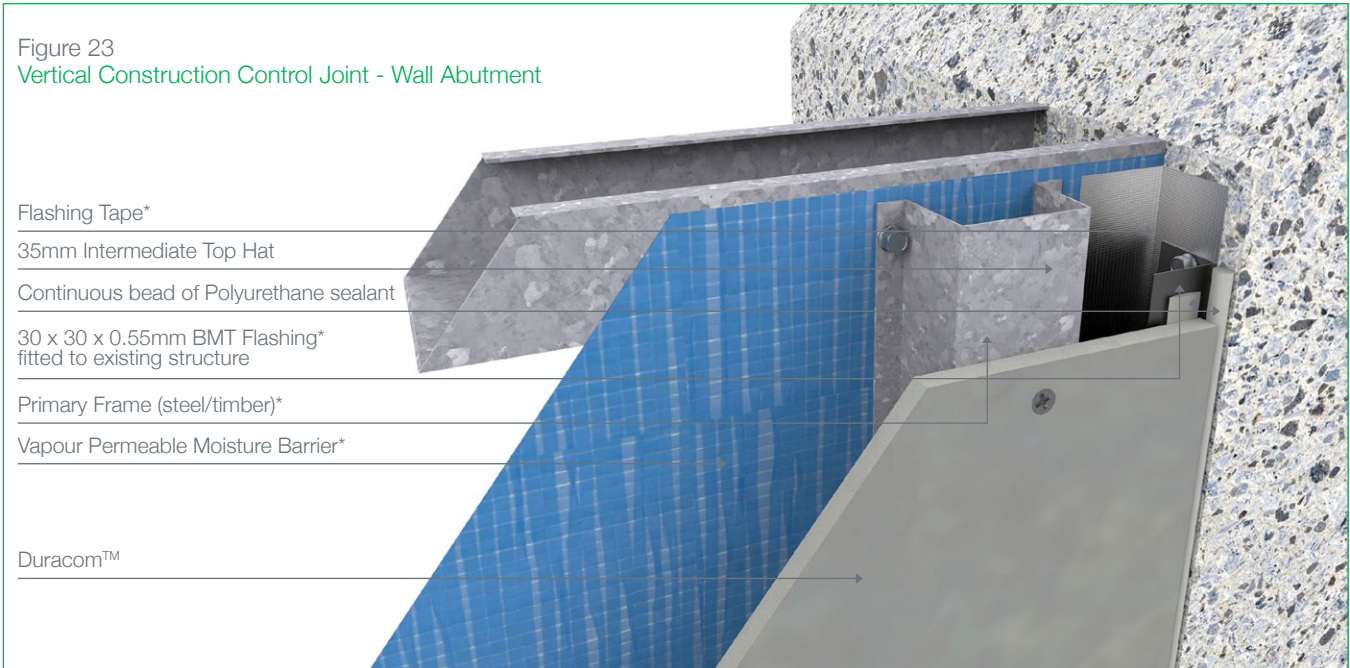
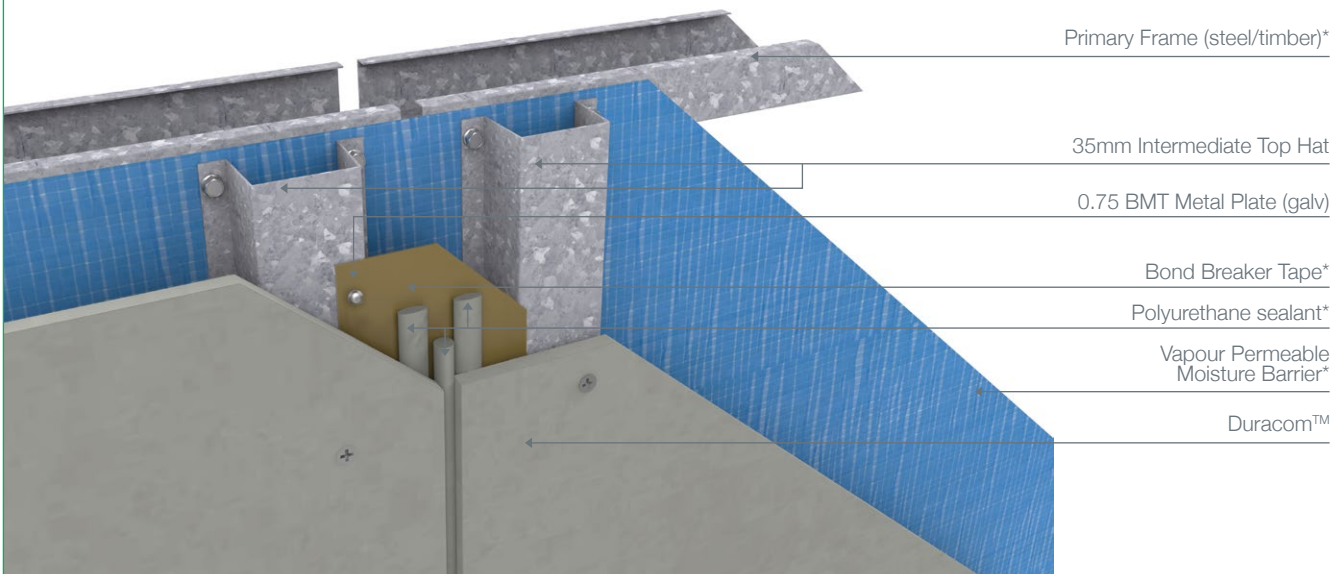

Figure 24
Vertical Control Joint



- Primary Frame (steel/timber)*
- 35mm Intermediate Top Hat
- 0.75 BMT Metal Plate (galv)
- Bond Breaker Tape*
- Polyurethane sealant*
- Vapour Permeable Moisture Barrier*
- Duracom™

*Components not supplied

Installation Details - Control Joint Details

Figure 25
Alternative Vertical Control Joint

Primary Frame (steel/timber)*

35mm Primary Top Hat

EPDM Foam Gasket

35mm Intermediate Top Hat

Vapour Permeable Moisture Barrier*

Duracom™

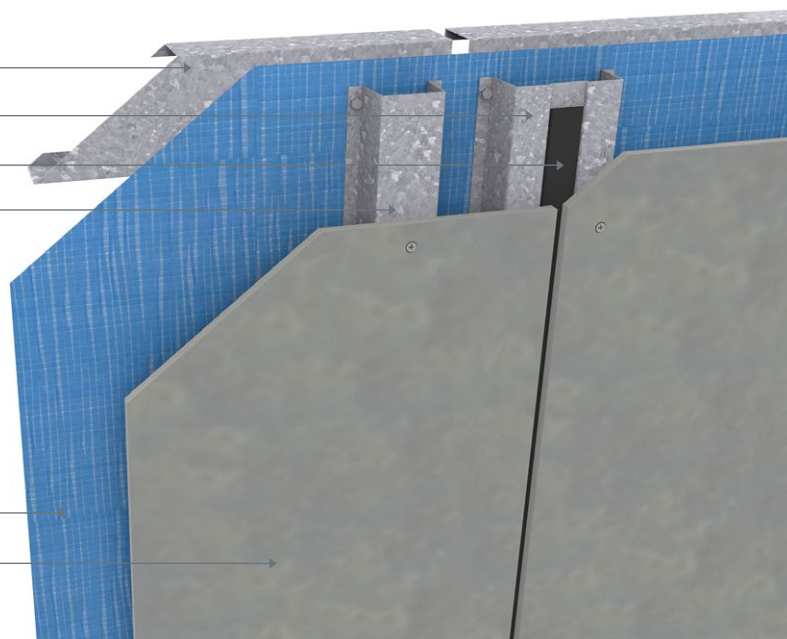

Figure 26
Horizontal Control Joint

Flashing Tape*

0.55 BMT Metal Plate (galv)*

'Z' Flashing Taped to Vapour Permeable Moisture Barrier*

Bond Breaker Tape*

Polyurethane sealant*

Primary Frame (steel/timber)*

35mm Intermediate Top Hat

Vapour Permeable Moisture Barrier*

Duracom™

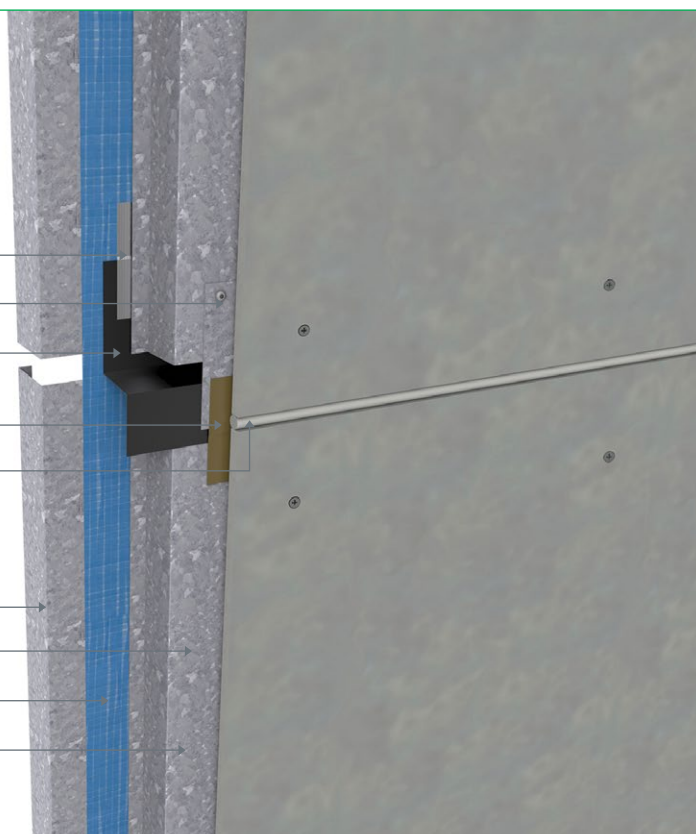

DURACOM™

WALL CLADDING SYSTEM

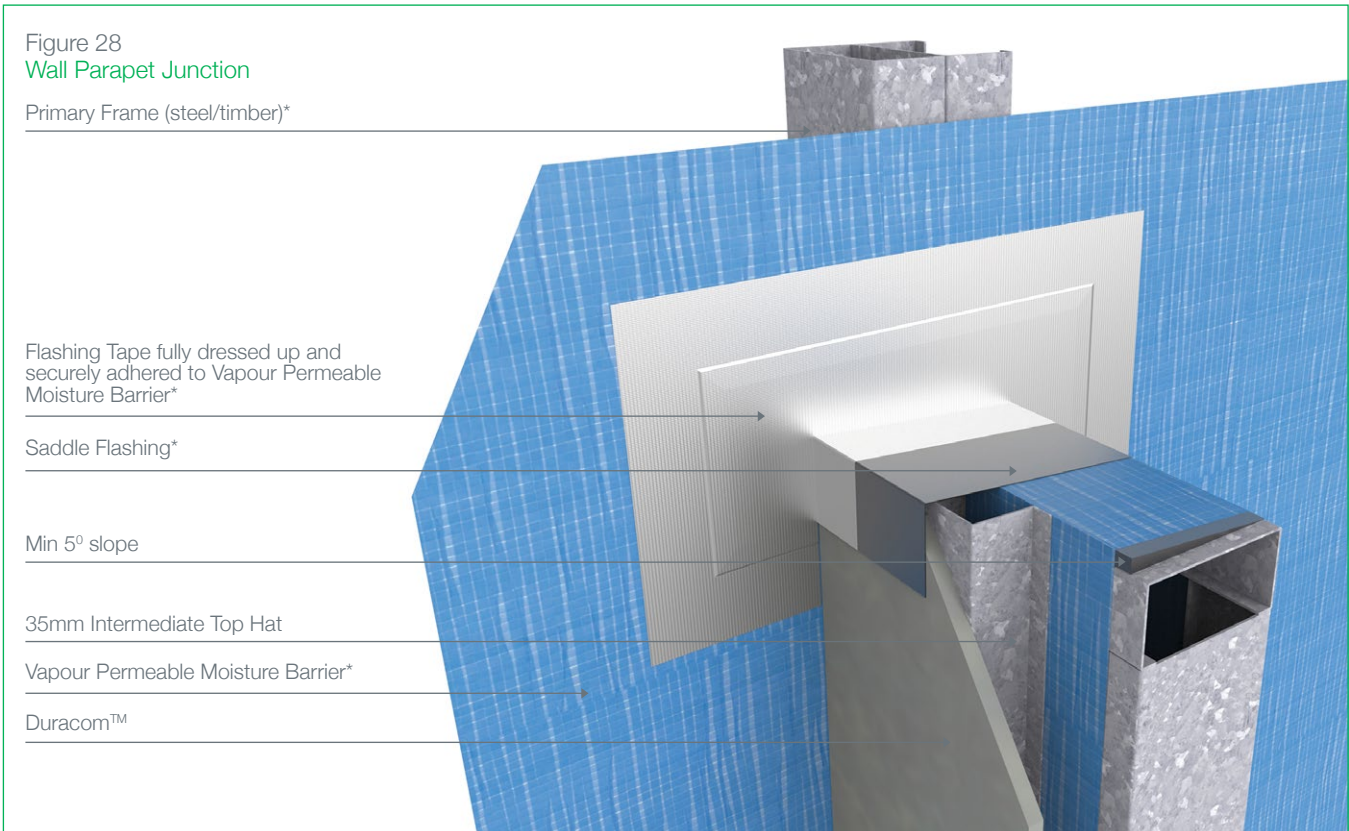
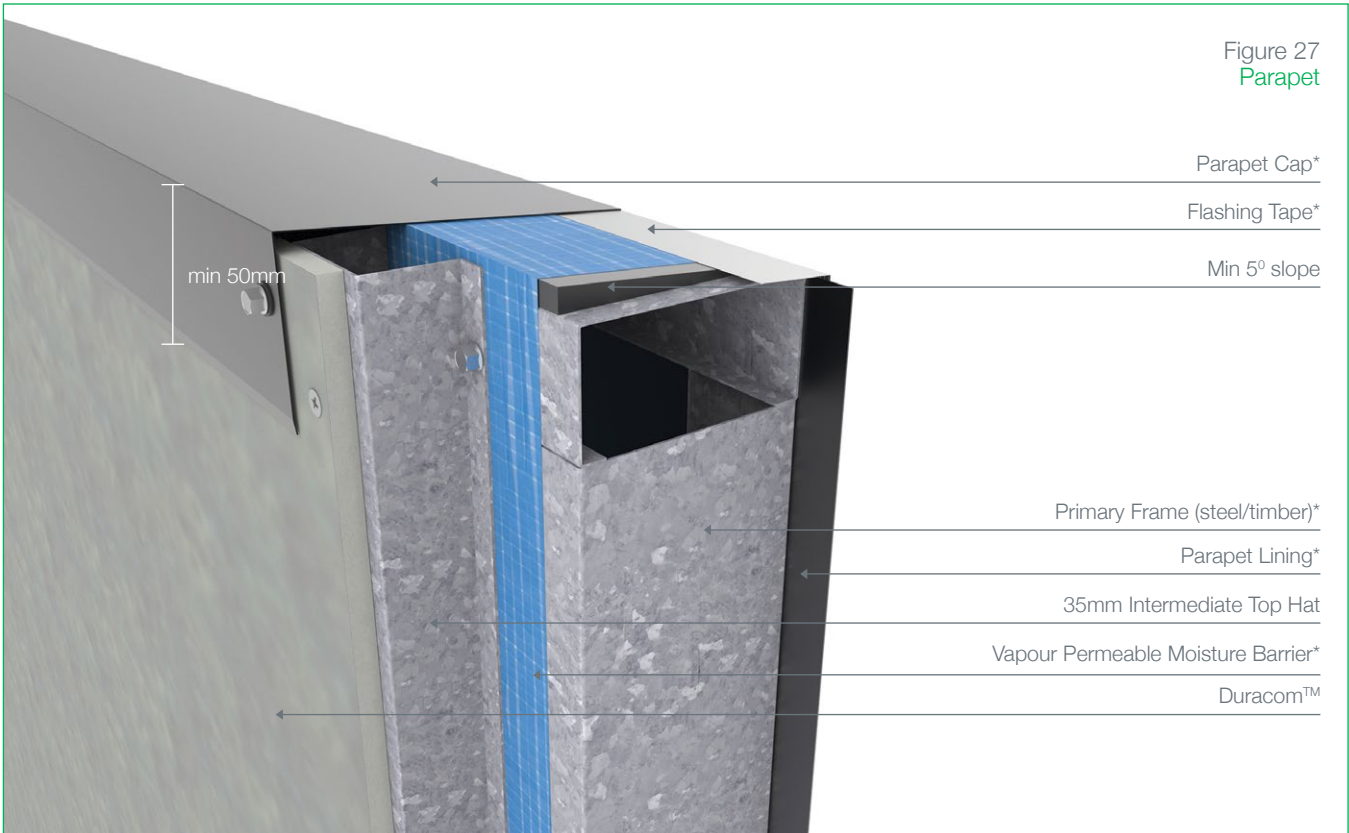

Installation Details

Figure 29
Scupper / Drain Overflow

Duracom™

35mm Intermediate Top Hat

Primary Frame (steel/timber)*

Flashing Tape*

Continuous bead of Polyurethane sealant*

Scupper Outlet*

Vapour Permeable Moisture Barrier*

Duracom™

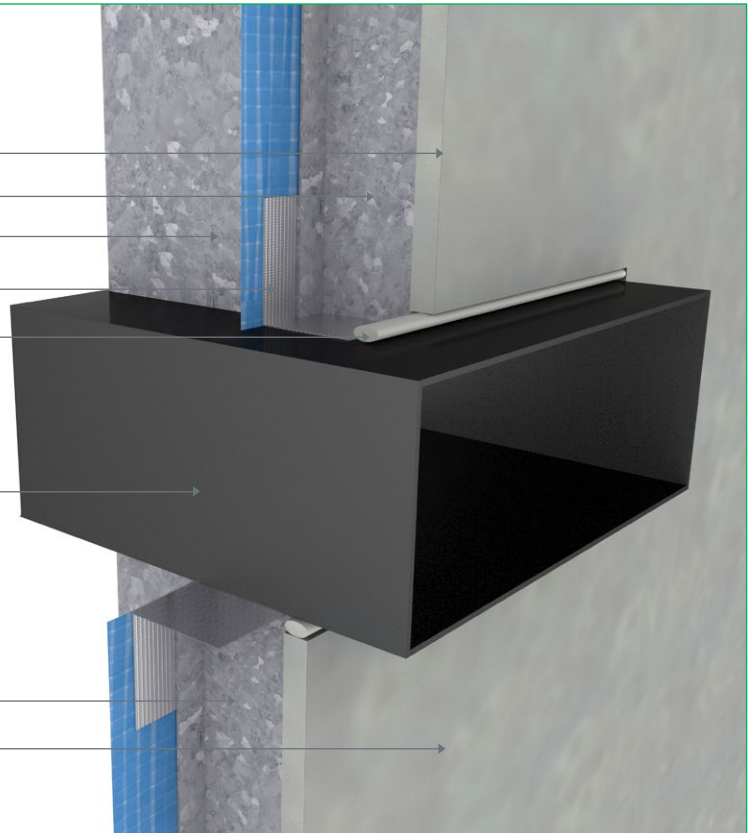

DURACOM™

WALL CLADDING SYSTEM

Deemed to Comply

For an up to date and complete list of our products that are 'Deemed to Comply' please refer to www.ntlis.nt.gov.au/deemedtocomply.

Painting and Decorating

Duracom™ is factory sealed on both faces and all edges. Sealing in this manner increases the durability and stability of the panels. The exterior surface of Duracom™ must be coated with an appropriate finish. The sealed back face is not suitable for exposure to ultraviolet light and therefore should not be exposed other than for short periods i.e. during installation. The sealed front face should be painted within three (3) months of initial exposure to ultraviolet light.

The exterior/front face of Duracom™ can be finished with a wide variety of coatings, provided they are compatible with the Duracom™ seal coat, fasteners and with the epoxy used to cover the countersunk heads. Exterior grade 100% acrylic paint will provide the best results. The use of gloss paint is not recommended.

Duracom™ may be painted off-site when exposed head screws are to be used. Refer to appropriate painting contractors for details and colours.

A minimum dry film thickness of 35 microns per coat is recommended to ensure adequate cover for the concealed fasteners. High gloss and low build finishes will require additional surface preparation to minimise fastener show-through. In all cases, the coating manufacturer's application instructions must be followed. The interior/back face of Duracom™ is finished clear and is not suitable for painting.

Before applying finishes in coastal areas, Duracom™ panels must be thoroughly washed with fresh water to remove any salt residue. Refer to coating manufacturer for additional requirements.

Duracom™ is not suitable for tiling.

Bushfire and Boundary Wall Areas

AS3959 sets out a series of bushfire threat levels to buildings described as BAL (bushfire attack levels) as follows: BAL-Low, BAL-12.5, BAL-19, BAL-29, BAL-40 or BAL-FZ (Flamezone).

Duracom™ is eminently suited for both bushfire and boundary wall applications in residential and multi-residential buildings.

Bushfire AS3959 Applications

Duracom™ may be used as a stand-alone product to achieve up to BAL-40 when fixed direct to frame as per the fixing instructions in this manual.

Duracom™, when used in conjunction with GTEK™ Fire and Wet Area 16mm will comply with the requirements of AS3959 and AS1530.4 to achieve BAL FZ (10m min. set back from vegetation).

Boundary/Exterior Walls

Duracom™, in conjunction with GTEK™ Fire and Wet Area 16mm can achieve both 60/60/60 and 90/90/90 FRL fire ratings from the outside as required by the NCC 2022.

In timber frame applications where an exterior wall is required to achieve 60/60/60 FRL, 1 layer of GTEK™ Fire and Wet Area 16mm installed with the Duracom™ to the outside walls as well as 10mm GTEK™ Wall on the inside will achieve this result.

In steel frame applications where an exterior wall is required to achieve 60/60/60 FRL 1 layer of GTEK™ Fire and Wet Area 16mm installed with the Duracom™ to the outside walls as well as 10mm GTEK™ Wall on the inside will achieve this result.

Similarly, 2 layers of GTEK™ Fireboard Wet Area 16mm used in conjunction with Duracom™ will achieve 90/90/90 from the outside.

NOTE: All exterior walls must have a vapour permeable moisture barrier directly behind the Duracom™ Wall Cladding System. No adhesives are to be used when installing GTEK™ Fire and Wet Area 16mm and the Duracom™ Wall Cladding System. Nails or screws must be used.

For more information please contact your nearest Fibre Cement office. Refer to GTEK™ Fire and Acoustic Guide for installation of fire rated plasterboard.

Bushfire and Boundary Wall Areas

Figure 30
Boundary / Exterior Walls / Timber Frame

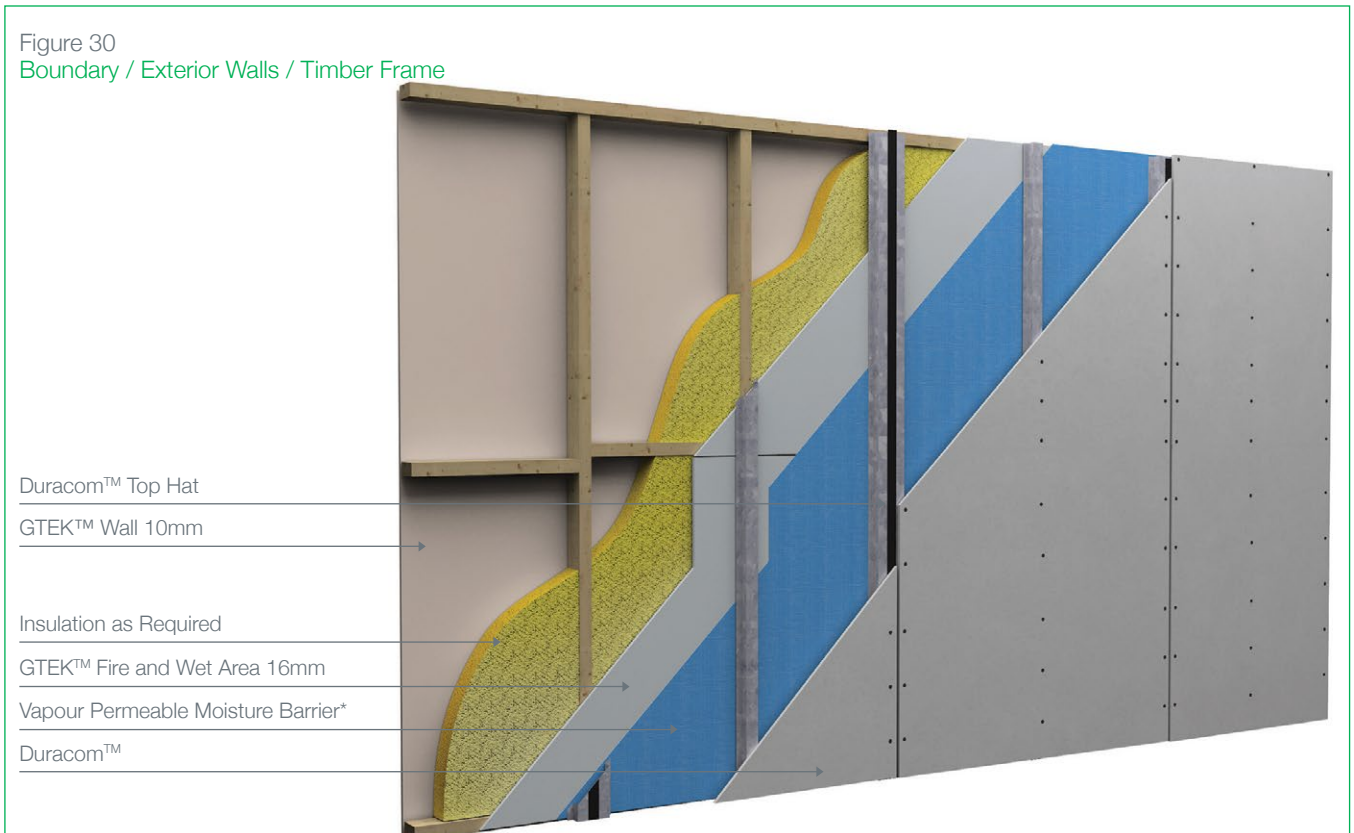

Figure 31
Boundary / Exterior Walls / Steel Frame



Warranty

We warrant that our products are free from defects caused by faulty manufacture or materials for the following period from the date of purchase:

- 25 years for the Nuline™ Plus, Stratum™ and Duraplank™ ranges
- 10 years for the Montage™ range and
- 15 years for all other Innova™ products

If you acquire any defective products, we will repair or replace them, supply equivalent replacement products or refund the purchase price within 30 days of receiving a valid claim, subject to product inspection and confirmation of the existence of a defect by Innova™. We will bear the cost of any such repair, replacement or refund.

This warranty is given by:

Etex Australia Pty Ltd

31 Military Road, Matraville, NSW 2036
Phone 08 9374 2900 Fax 08 9374 2901

To claim under this warranty, you must provide proof of purchase as a consumer and make a written claim (including any costs of claiming) to us at the address specified above within 30 days after the defect was reasonably apparent, or if the defect was reasonably apparent prior to installation, the claim must be made prior to installation. You may not claim under this warranty for loss or damage caused by:

- faulty or incorrect installation by non-Innova™ installers (Innova™'s installation procedures are at innovafibre.com.au);
- failure to comply with the Building Code of Australia or any applicable legislation, regulations approvals and standards;
- products not made or supplied by Innova™;
- abnormal use of the product; or
- normal wear and tear.

The benefits available under this warranty are in addition to other rights and remedies of the consumer under the law. Our goods come with guarantees that cannot be excluded under the Australian Consumer Law. You are entitled to a replacement or refund for a major failure and for compensation for any other reasonably foreseeable loss or damage.

You are also entitled to have the goods repaired or replaced if the goods fail to be of acceptable quality and the failure does not amount to a major failure.

Adelaide
Telephone
08 8480 1700

Sydney
Telephone
02 8107 9500

Brisbane
Telephone
07 3548 8400

New Zealand
Telephone
0011 64 9273 1457

Melbourne
Telephone
03 9492 1700

Technical Helpline
1300 652 242

Perth
Telephone
08 9311 5500

f /InnovaBuildingSystems
@innovabuildingsystems
/Innova Building Systems



innovafibre.com.au

EXTERIOR PRODUCTS AND APPLICATIONS

DURACOM™ / A compressed fibre cement wall cladding system.

DURAFLOOR™ / The ultimate flooring product that can be used in both interior and exterior applications.

DURAGRID™ RESIDENTIAL & DURAGRID™ LIGHT COMMERCIAL / A lightweight wall cladding system giving a modern and durable finish.

DURAGROOVE™ / A vertically grooved exterior wall cladding system.

DURASCAPE™ / A lightweight exterior wall cladding system with a subtle vertical shadow line.

MONTAGE™ / A versatile pre-finished wall cladding system that can be used internally and externally.

NULINE™ PLUS / A weatherboard style cladding system.

STONESHEET™ / Purpose designed substrate for stone tile facade.

STRATUM™ / A range of plank products, each of which can be used as stand-alone products or used together to create a striking exterior cladding solution.

DURASHEET™ / Ideal for the cladding of gables and lining of eaves. Can also be used on commercial soffits and cladding on non-impact areas.

DURAPLANK™ / Available in Smooth, Woodgrain and Rusticated finishes, Duraplank™ is ideal for exterior cladding of upper storey conversions or ground level extensions.

DURATEX™ / A base sheet used for textured coatings on exterior wall applications.

DURALINER™ PLUS / An exterior lining board that is the perfect substrate for tiles and is ideal for wet areas.

COMPRESSED / Used as a domestic, commercial sheet for wet areas, flooring, partitions, exterior decking, fascia and wall cladding.

DURALUX™ PLUS / Suitable for exterior applications where it will be sheltered from direct weather.

INTERIOR PRODUCTS AND APPLICATIONS

INTERGROOVE™ / Internal grooved wall lining.

DURALUX™ PLUS / An interior lining board suitable for ceilings and soffits.

DURALINER™ PLUS / An interior lining board, this is the perfect substrate for tiles and is ideal for wet areas.