



# Stair Stringer Collection

Engineered for  
superior strength.



**NEPEAN**  
Building &  
Infrastructure

TM



Each offering a superior level of strength & performance, the range of **Dual** and **Mono Stringers** can be configured to meet a variety of height requirements and applications.

### **Structurally Sound**

Engineered to provide solid under foot accessibility between levels with minimal deflection and optimal comfort.

### **Fully Compliant**

All components have been tested to last, manufactured from high-quality steel. Fully compliant with relevant Australian Standards and the National Construction Code when installed correctly.

### **Easy Installation**

Cleverly designed for efficient installation on site. Dual and mono stringers are supplied with mounting brackets in place with individual installation guides available.



MONO STRINGERS  
ARE MADE-TO-ORDER  
IN AUSTRALIA.



# DUAL STRINGER

Configurable off the shelf in 1 to 17 treads in a continuous pair, Dual Stringers can cover up to 3150mm in vertical height.

Suitable for interior or exterior applications, Dual Stringers are robust and weather resistant, hot-dip galvanised for maximum corrosion resistance.

Designed with walking comfort in mind, Dual Stringers have an incline angle of 35 degrees with steps placed at a consistent 175mm rise allowing for a 'going' distance of 250mm.

- ✓ Simple to configure design.
- ✓ Easy to install via concrete cast-in or optional bolt-down bracket available.
- ✓ Hot-dip galvanised to AS/NZS 4680:2006.
- ✓ Designed to take a maximum tread width of 1000mm.
- ✓ Rectangular Hollow Sections (RHS) of up to 5mm thickness.
- ✓ Complies with the National Construction Code<sup>^</sup> when a minimum tread height of 50mm is used.
- ✓ Complies with AS1657:2018, engineered to the requirements of AS1170.1:2002 (up to a UDL of 4.0kPa and a point load of 4.5kN).

## Configuring Dual Stringers

To calculate the number of treads required simply:

1. Measure the vertical height from the ground to the finished floor level of the landing.
2. Divide the height by the rise of each tread (175mm)
3. Round the result to the nearest whole number, then reduce by one for the top landing. The result is the number of treads required.

Dual Stringer Product Code	Number of Treads	Vertical Height# (mm)	Horizontal Distance# (mm)	RHS Thickness (mm)	Weight Per Pair (kg)
G1TS	1	350	240	3	8
G2TS	2	525	490	3	14
G3TS	3	700	740	3	19
G4TS	4	875	990	3	24
G5TS	5	1050	1240	3	30
G6TS	6	1225	1490	3	35
G7TS	7	1400	1740	3	41
G8TS	8	1575	1990	3	46
G9TS	9	1750	2240	3	51
G10TS	10	1925	2490	3	57
G11TS	11	2100	2740	3	62
G12TS	12	2275	2990	3	67
G13TS	13	2450	3240	5	105
G14TS	14	2625	3490	5	113
G15TS	15	2800	3740	5	120
G16TS	16	2975	3990	5	128
G17TS	17	3150	4240	5	136

*For Example:  
Height = 1000mm  
divided by  
175mm = 5.71.  
Rounded up to 6,  
then reduced by  
1 = 5 tread  
configuration  
required.*

<sup>^</sup> Dual Stringers comply with the requirements of the National Construction Code Volume 2 for Class 1 and 10 buildings Part 3.9.1 when installed with treads at least 50mm thick. The minimum 50mm thick tread is to meet the dimensional requirements of Figure 3.9.1.4 to prevent a 125mm sphere from passing between the treads.

# DUAL STRINGER

To comply with the National Construction Code the rise of each tread MUST be consistent. This includes the first step and the last step up to the landing platform. To achieve a consistent rise the ground level may need to be built up.

Always use appropriate safety measures and protective equipment when carrying out installation work.

## Additional Parts

Dual Stringers are supplied as pairs with tread mounting brackets. Additional parts are available on request.

*Fixings not included.*



### Tread Mount Bracket

**Product Code:** GTMB

Pack Size: Each

Item Weight: 0.42kg

L: 200mm, W: 57mm, H: 71mm

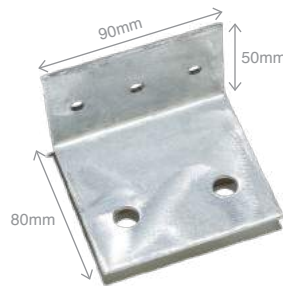

### Bolt-Down Bracket

**Product Code:** GBDB

Pack Size: Each

Item Weight: 0.27kg

L: 90mm, W: 55mm, H: 80mm

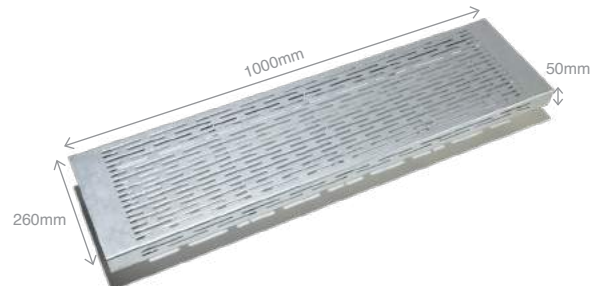

### Steel Stair Treads

**Product Code:** GTNS655-MK2

Pack Size: Each

Item Weight: 9.5kg

L: 1000mm, W: 260mm, H: 50mm

All accessories are hot-dip galvanised for lasting corrosion resistance.



Learn More



## Installation Guidelines

Dual Stringers can be cast-in position or bolted down to a secure concrete surface using the optional bolt-down bracket.

An on-product label will include a QR code to download instructions for easy on-site reference.

## Bolt Down Installation

### Step 1.

Measure vertical height and ensure risers are consistent. Ground level may need to be built up to suit.

### Step 2.

Cut off cast-in leg (item 1) to suit.

### Step 3.

Bolt stringer mounting bracket (item 4) to vertical face.

### Step 4.

Tek screw bolt-down bracket (item 5) to each leg.

### Step 5.

Anchor bolt-down bracket to suitable concrete plinth.

### Step 6.

Fix treads using suitable and appropriate fixings.

## Cast In Installation

### Step 1.

Measure vertical height and ensure risers are consistent. Ground level may need to be built up to suit.

### Step 2.

Excavate suitable footing.

### Step 3.

Bolt stringer mounting bracket (item 4) to vertical face.

### Step 4.

Concrete the stringer cast-in leg (item 1) into place.

### Step 5.

Fix treads using suitable and appropriate fixings.

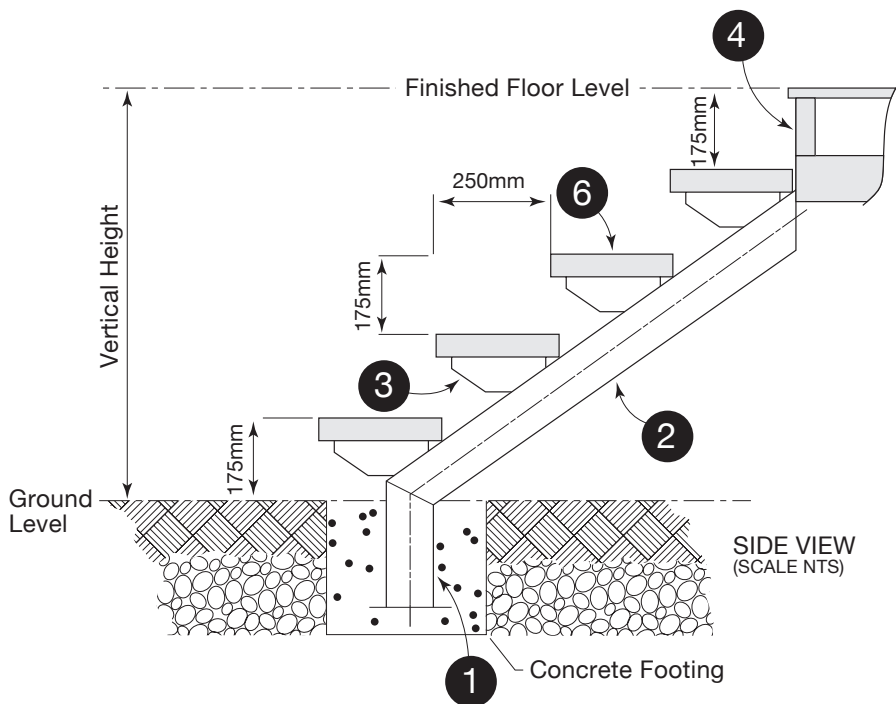
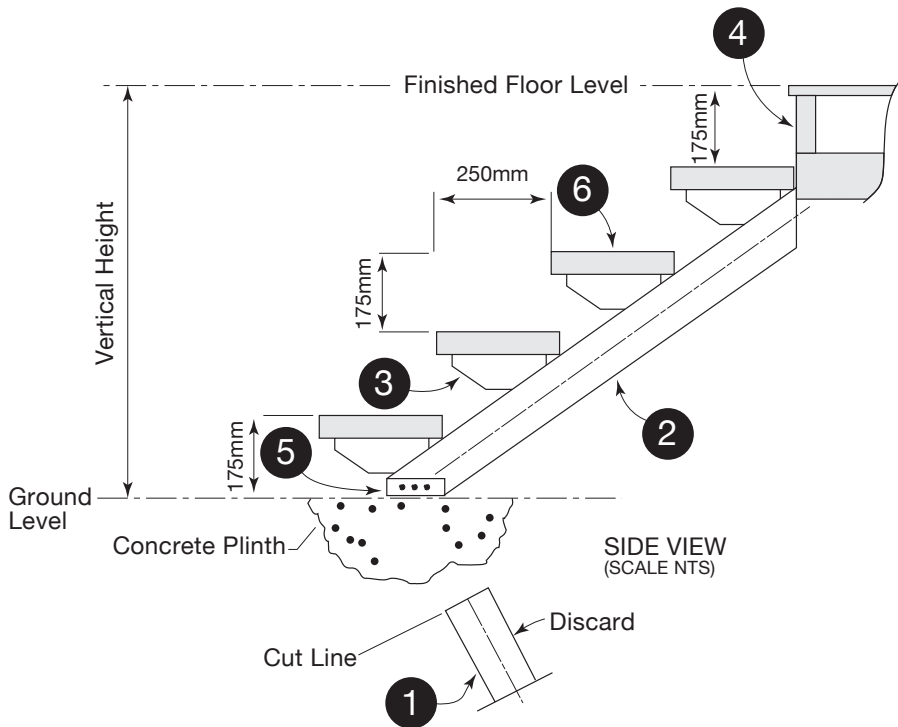

### Key:

- 1 Stringer cast-in leg
- 2 Stringer
- 3 Tread mounting bracket
- 4 Stringer vertical mounting bracket
- 5 Optional bolt-down bracket
- 6 Stair tread



## MONO STRINGER

Contemporary styling to create an architectural feature, the Mono Stringer provides a custom solution for floor to landing (FL) or landing to landing (LL) applications.

Suitable for multi-storey dwellings, the robust design has been proof loaded up to 3200kg on 17 treads. For added peace of mind, Mono Stringers are designed with full engineering drawings specific to your project.

Suitable for interior or exterior applications ranging from 2 to 17 treads for vertical clearances of 504mm to 3300mm.

Mono Stringers can be finished as untreated steel, powdercoat including popular Dulux® colours or hot-dip galvanised for maximum corrosion resistance.

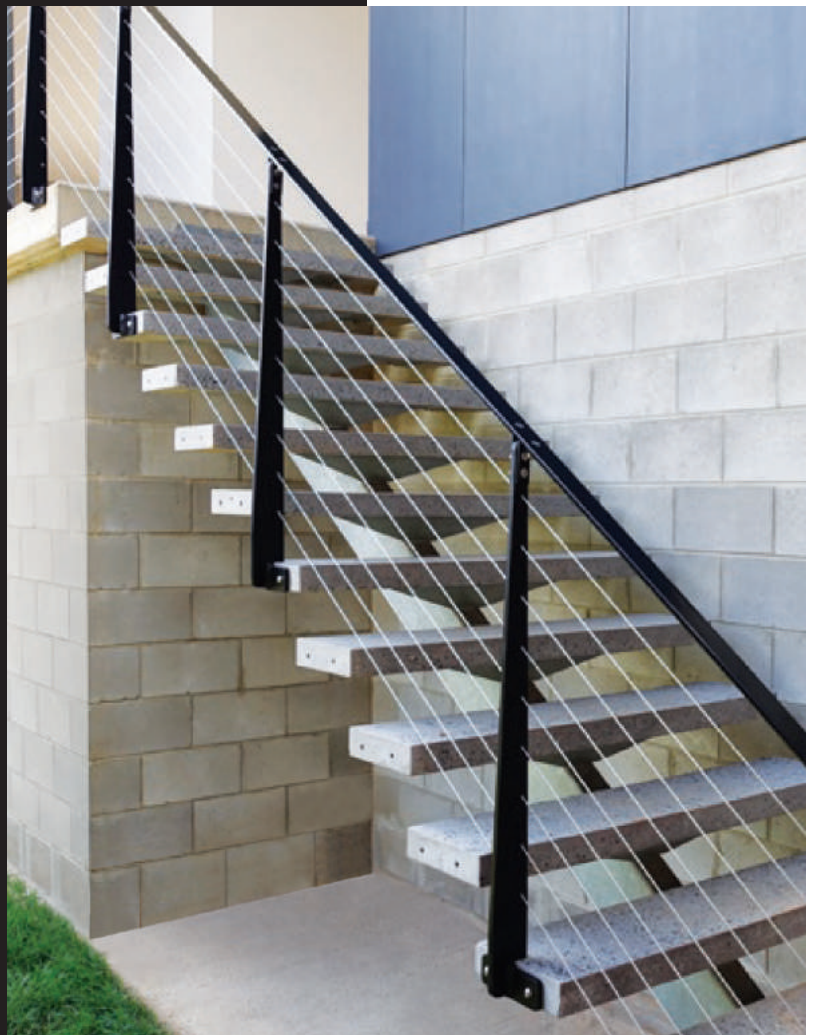

Mono Stringers have a comfortable incline angle of 35 degrees with a selectable rise of between 168mm to 185mm depending on the application.

- ✓ Flexible design can be configured to each project.
- ✓ Design allows face or floor installation with Dyna bolts or Chemstuds (not supplied).
- ✓ Hot-dip galvanised finishes comply with AS/NZS 4680:2006.
- ✓ Designed to suit stair treads widths of between 900mm and 1200mm.
- ✓ Stair treads of between 250mm and 300mm in depth and between 45mm to 75mm can be accommodated.
- ✓ Complies with the National Construction Code when correctly installed.

*Step-depths can be customised based on the total number of treads required.*

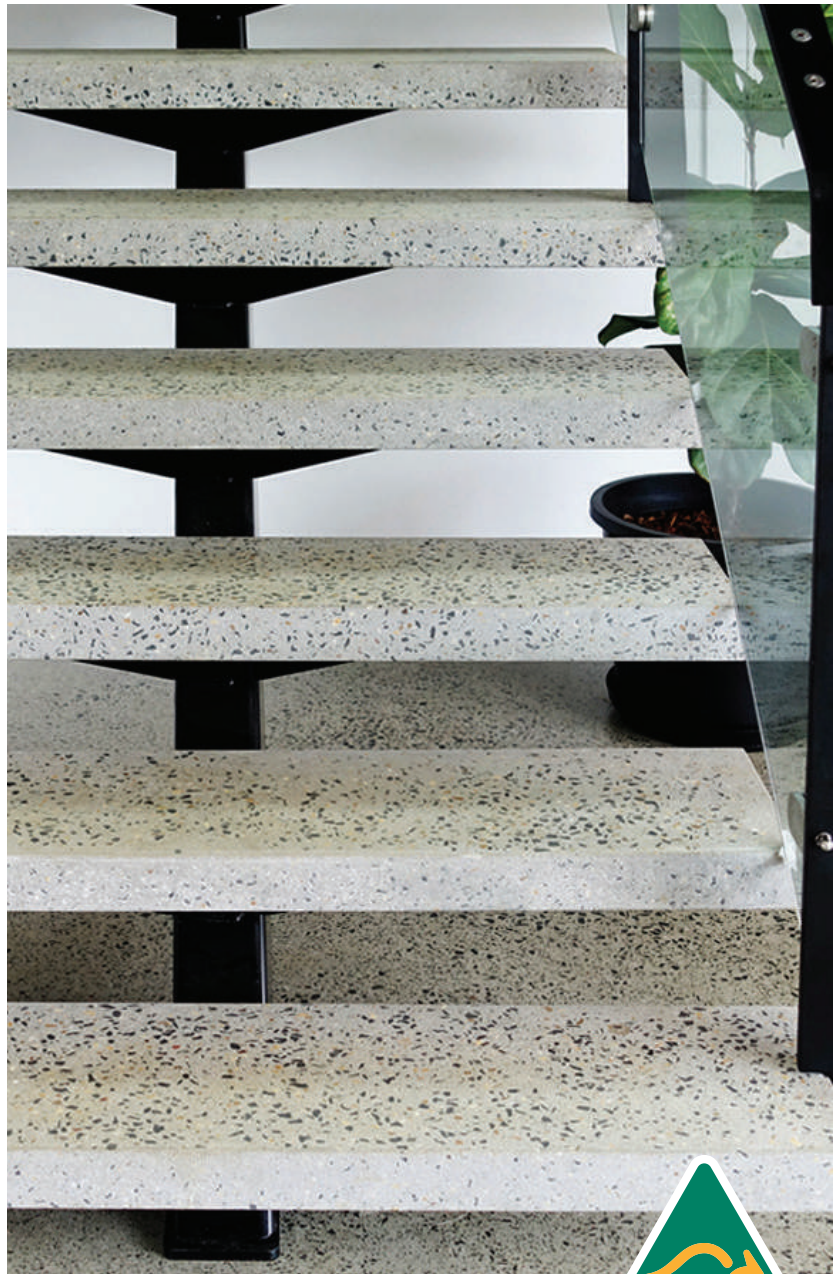

MONO STRINGERS  
ARE MADE-TO-ORDER  
IN AUSTRALIA.

# MONO STRINGER

## Design Configuration

Mono stringers can be installed as Floor-to-Landing or Landing-to-Landing.

To configure the perfect design for use, simply:

1. Determine which of the below installation styles are required.
2. For Floor-to-Landing installation: (Image A) Confirm the overall height, including all floor coverings such as tiles.
3. For Landing-to-Landing installation: (Image B) Confirm the overall face to face distance between installation points.
4. Calculate the number of steps required using the below technical data.
5. Select the finished functional tread thickness (FT). A tread thickness of 45mm is recommended.
6. Choose the desired finish. Mono Stringers used externally or in environments with moisture, hot-dip galvanising is recommended.



Total Height (B) in mm		Horizontal Length (HL) in mm		Number of Risers (QR)	Number of Treads (QT)	Rise (R) in mm		Tread Thickness (TT) in mm		Going (G) in mm	
Min	Max	Min	Max			Min	Max	Min for 168 (R)	Min for 185 (R)	Min	Max
504	555	511	559	3	2	168	185	45	60	236	236
672	740	751	824	4	3	168	185	45	60	236	236
840	925	991	1088	5	4	168	185	45	60	236	250
1008	1110	1231	1352	6	5	168	185	45	60	236	250
1176	1295	1471	1616	7	6	168	185	45	60	236	264
1344	1480	1711	1880	8	7	168	185	45	60	236	264
1512	1665	1950	2145	9	8	168	185	45	60	236	243
1680	1850	2190	2409	10	9	168	185	45	60	236	243
1848	2035	2430	2673	11	10	168	185	45	60	236	257
2016	2220	2670	2937	12	11	168	185	45	60	236	257
2184	2405	2910	3201	13	12	168	185	45	60	236	236
2352	2590	3150	3466	14	13	168	185	45	60	236	236
2520	2775	3390	3730	15	14	168	185	45	60	240	250
2688	2960	3630	3994	16	15	168	185	45	60	240	250
2856	3145	3870	4258	17	16	168	185	45	60	240	264
3024	3330	4110	4523	18	17	168	185	45	60	240	264



**A Floor-to-Landing (FL)**

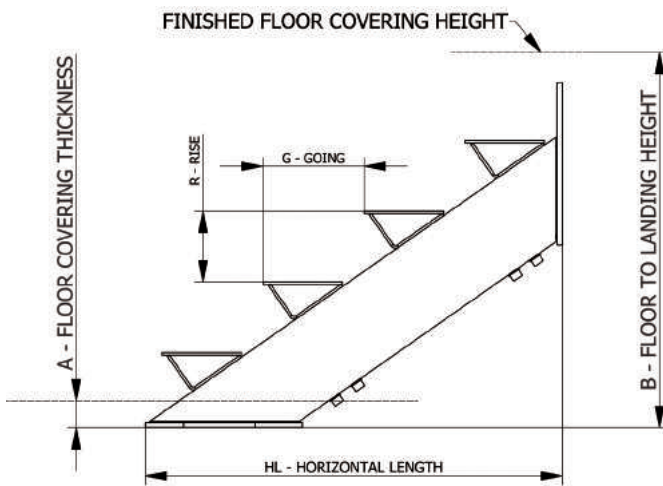

**B Landing-to-Landing (LL)**

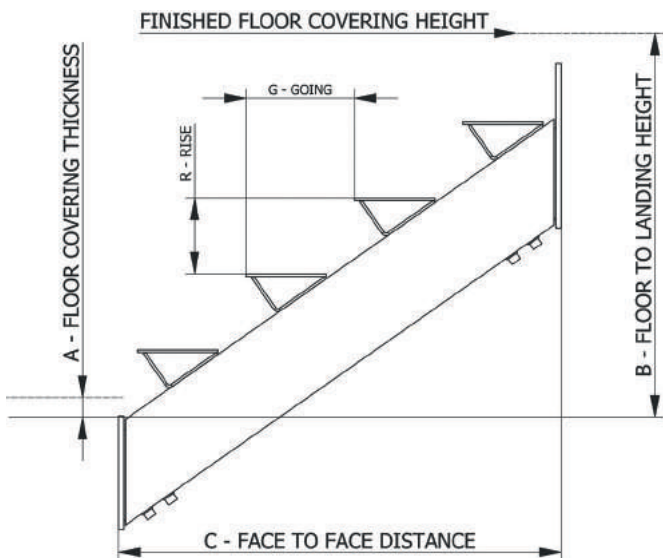

**C Tread Thickness including Nosing**

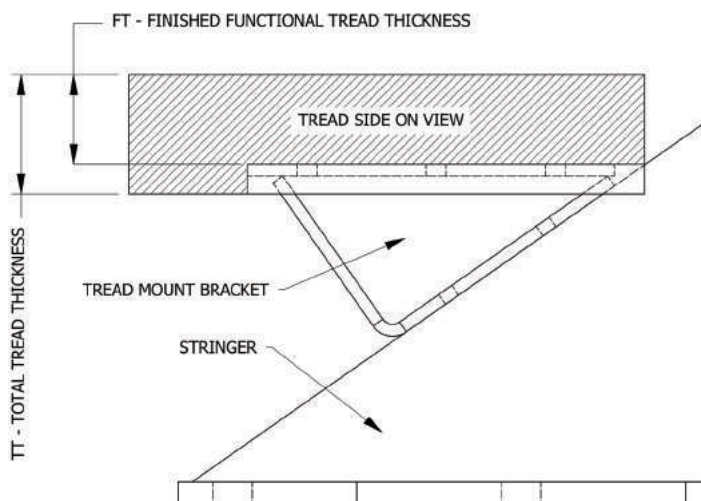

**Installation Styles**

Refer to the diagrams to determine which installation style is required for Step 2, and to confirm the functional tread thickness (FT).

**A Note 1:** Finished Floor Heights are critical to ensure the even spacing of tread risers for comfort, standards compliance and quality appearance.

**B Note 2:** Dimension C in figure 2 can be calculated if dimensions A and B are known. Contact Galintel to obtain dimension C and confirm ability to install.

**C** The functional tread thickness (FT) is the distance from the top surface to underside surface not including any nosing or skirting affixed to the front of the tread.

## Installation Guide

Mono Stringers have been engineered to comply with the National Construction Code when installed in accordance with the following instructions.

For further information visit [galintel.com.au](http://galintel.com.au)



**Step 1** Ensure that the top and bottom mounting brackets are square to the Stringer beam. Tighten the four (4) M16 Socket Head Cap Screws to 120 Nm (88 ft/lb).



**Step 2** Mark the centreline of the desired stair location.



**Step 3** Set up a level at the top finished floor height.

**Step 4** Trim or Fold the provided marking template.

**Step 5** Set the template so as the centre line is vertical and the top is in contact with the underside of the level (Step 3).

**Step 6** Mark the four (4) hole centres. This builder is using a 6mm Dyna drill to accomplish this.

**Step 7** Drill the marked hole the correct size for the desired fixing method. (Minimum M12 fixing for Concrete, and M16 fixing for Timber).



**Step 8** If using Chemstuds or Dyna bolts set these at the desired depth.

**Step 9** Lift the Stringer assembly into place (it is best to have the unit slightly top heavy).



**Step 10** Loosely tighten the top fixings to allow for adjustments of levels and alignments.

**Step 11** Level the top tread whilst ensuring the stringer is in the desired location at both top and bottom. Wedges or spacers may be required depending on the accuracy of the substrate.

**Step 12** Drill the bottom holes. In most cases this is achievable without removing the Stringer. On odd occasions depending on the bottom finished floor height the stringer may need to be removed.

**Step 13** Once the Stringer is levelled in the correct location tighten the mounting bolts to the recommended torques.



**Step 14** Fit your selected stair treads. Speak with your retailer or architect for recommended options.

**Step 15** Install your selected Handrail or Balustrade in accordance with the National Construction Code.



# MONO STRINGER

## Order Form & Checklist

Mono Stringers are made-to-order with engineering diagrams provided for approval before production.

To place a custom order simply follow the steps below and email your completed form to [galintel@nepean.com](mailto:galintel@nepean.com)

For more information on how to order please speak with your retail or trade centre experts.

---

a. Mount Type (tick applicable)  Floor-to-Landing (FL)  Landing-to-Landing (LL)

---

b. Finished Floor Height – Base Floor A =  mm

---

c. Finished Floor Height – Top Floor B =  mm

---

d. Number of Treads (calculated as per Step 3, page 8) N =  each

---

e. Finished Functional Tread Thickness (Custom tread only – Step 5, page 8. Refer to figure C on page 9) FT =  mm

---

f. Location – Internal or External  Internal  External  
NOTE: We recommend hot-dip galvanised finish for external applications.

---

g. Finish Options (tick applicable)  Untreated  Powdercoated  
 Hot-Dip Galvanised

---

h. Powdercoat Colours  Black – Matt  
 Black – Gloss  
 Nominated Colour

---

Notes \_\_\_\_\_

\_\_\_\_\_

\_\_\_\_\_

\_\_\_\_\_

\_\_\_\_\_



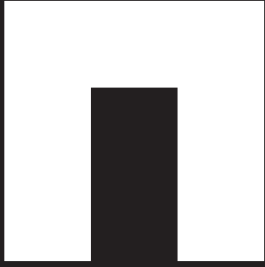

**NEPEAN**  
Building &  
Infrastructure

TM

Australia's largest  
integrated manufacturer  
and supplier of galvanised  
metal products for  
residential, commercial  
and industrial buildings.

Proudly Australian Owned.



Information contained in this brochure is supplied in good faith and with the view to assist the user in the correct selection of our products. While every care is taken to ensure that the information contained in this brochure is correct, no warranty is made nor is any condition expressed or implied. As the use of products sold is beyond our control, a condition of purchase is that the purchaser accepts responsibility for ensuring that products purchased are suitable for the intended use. NEPEAN Building & Infrastructure is committed to continual product improvement and therefore reserves the right to change details and designs without notice. All dimensions listed in this brochure are nominal sizes. ^Dual Stringers comply with the requirements of the National Construction Code Volume 2 for Class 1 and 10 buildings Part 3.9.1 when installed with treads at least 50mm thick. The minimum 50mm thick tread is to meet the dimensional requirements of Figure 3.9.1.4 to prevent a 125mm sphere from passing between the treads. © Copyright 2023 NEPEAN Building & Infrastructure [ABN 54 125 224 302]. A division of NEPEAN. [11/2023]

### **Ready to Order?**

Speak with your local retailer or trade centre to help configure the right solution for your needs.

For more information visit us online at  
[galintel.com.au](http://galintel.com.au) or call **1800 LINTEL**