

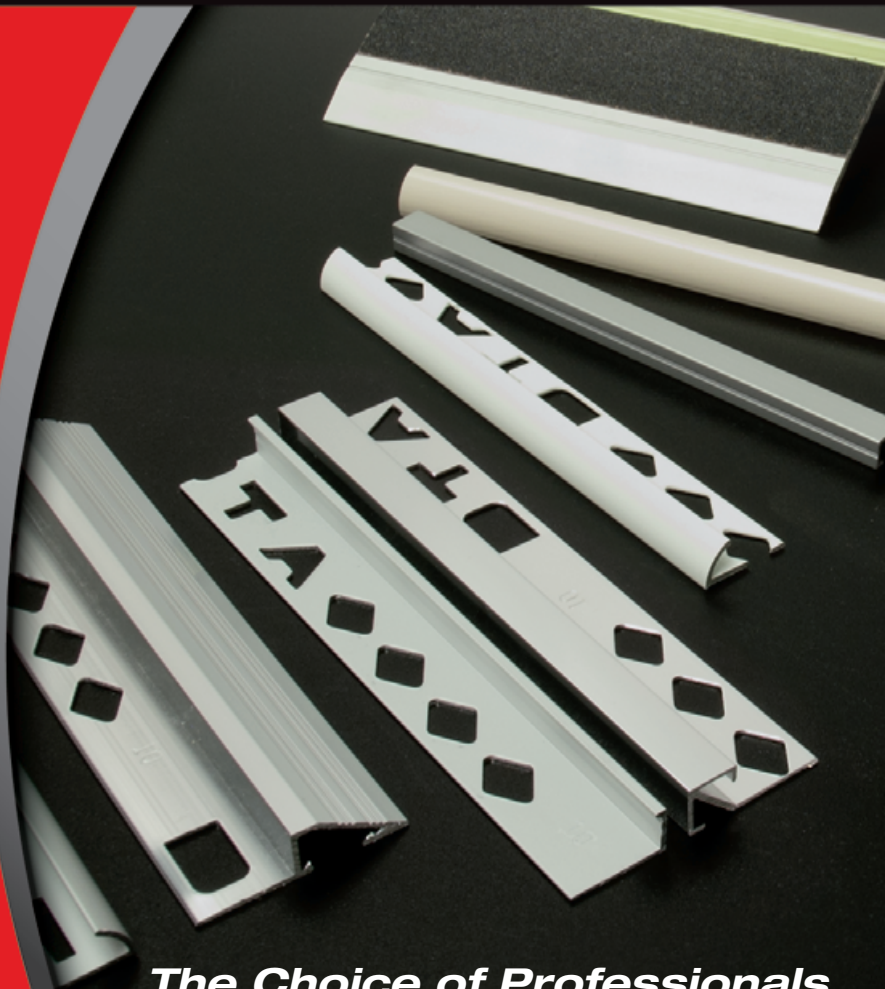

Architectural Trims

Catalogue Edition 4



The Choice of Professionals



The Choice of Professionals

Trims are an essential element in delivering a professionally finished project, and at DTA, our trims are of recognised industry standard. While many DTA trims are manufactured in Australia using local and imported materials, others are imported. Whether locally manufactured or imported, DTA ensure they maintain the highest quality product standards. DTA's market leadership is the result of a quality product range, developed through consultation with local and international trades. Through extensive research in both European and Asian markets, DTA are able to offer a range of trims that will satisfy the most demanding of customer applications. While most DTA trims will be available from retailers or from the DTA state warehouses, specialised profiles can be supplied with a phone call to a DTA state office.

TRIM SELECTION

4



EDGE TRIM

5

PVC Round Edge Trim	6
Aluminium Round Edge Trim	7
Brass Round Edge Trim	8
Aluminium Square Edge Trim	9
PVC Square Edge Trim	10
Aluminium L-Shape Trim	11
Unperforated Aluminium L-Shape Angle	12
Formable L-Shape Angle	12
Brass L-Shape Trim	13
Stainless Steel Round Edge Trim	14
Stainless Steel L-Shape Trim	15
Stainless Steel Square Edge Trim	16

TRANSITION TRIM

17

Aluminium Flat Listello Trim	18
Aluminium Transition Edge Trim	19
Aluminium Step Edge Trim	20
Aluminium Dividing Trim	20

COMMERCIAL TRIM

21

PVC Movement Joints	22
PVC Screed Movement Joints	22
Aluminium and Brass Movement Joints	23
Stainless Steel Movement Joints	24
Commercial Aluminium Stair Tread	25
Commercial Aluminium Stair Tread with Illumination	25
Aluminium All Purpose Cove Trim	26
Aluminium Cove Trim	27
Aluminium Cove Trim Corners	28
Balcony Trim and Corners	29
Joiners	29

MERCHANDISING

30

INDEX



TRIM SELECTION



STAINLESS STEEL
Grade 304 and 316L (Marine Grade)
Ideal for coastal areas

Highly recommended for public and high traffic areas due to mechanical strength and chemical resistance. It is used in many architectural and technical applications.



BRASS
Grade C380

Brass is an elegant material and is highly regarded by architects and interior designers. It is best suited to indoor application and has a warm gold colour.



ALUMINIUM
Grade 6063T5 (Plain & Anodised)

Aluminium has a wide variety of applications and is sought after for its range of profiles and complex shapes. Aluminium is also lightweight, ductile and easy to cut and use. DTA offer many variants of finish, including bright and matt colour anodising.



PVC
UV Stabilised

A remarkably versatile material that has wide ranging applications in many building projects because of its corrosion resistance. Available in many designer colours. It is economical and easy to use. Not recommended for external use.

Handy Hint – Always remove excess grout immediately after grouting to avoid discolouration.



EDGE TRIM

EDGE TRIM

DTA Finishing Edge Trims are designed to provide edge protection where tiles are bordered by carpet or timber, or as a decorative edging.

The DTA Finishing Trims range adds a contemporary look, while still providing maximum tile protection.

Finish Edge Trims are available in PVC, Aluminium, Brass and Stainless Steel finishes.

PVC Round Edge Trim - 2.5metre

- PVC round edge trim
- Professional looking quadrant finish
- Highest grade PVCU construction
- Use with all tile types
- Available in 17 fashionable colours

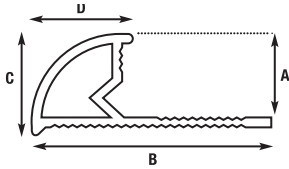

Size A	B	C	D
6mm	22mm	8mm	8mm
8mm	23mm	11mm	10mm
10mm	27mm	12mm	11mm
12mm	31mm	15mm	9mm



External Corner Trim – Horizontal



External Corner Trim – Vertical



Finishing Trim

EDGE TRIM

Colour	6mm		8mm		10mm		12mm	
	Code	Pk Qty	Code	Pk Qty	Code	Pk Qty	Code	Pk Qty
White	TT625W	100	TT825W	100	TT1025W	80	TT1225W	80
Ivory	TT625IY	100	TT825IY	100	TT1025IY	80	TT1225IY	80
Vanilla	TT625V	100	TT825V	100	TT1025V	80	TT1225V	80
Apricot	TT625A	100	TT825A	100	TT1025A	80	TT1225A	80
Peach	TT625P	100	TT825P	100	TT1025P	80	TT1225P	80
Beige	TT625BE	100	TT825BE	100	TT1025BE	80	TT1225BE	80
Grey	TT625GY	100	TT825GY	100	TT1025GY	80	TT1225GY	80
Green	TT625GN	100	TT825GN	100	TT1025GN	80	TT1225GN	80
Black	TT625BK	100	TT825BK	100	TT1025BK	80	TT1225BK	80
Travertine	TT625T	100	TT825T	100	TT1025T	80	TT1225T	80
Havana	TT625H	100	TT825H	100	TT1025H	80	TT1225H	80
Jasmine	TT625J	100	TT825J	100	TT1025J	80	TT1225J	80
Mocha	TT625M	100	TT825M	100	TT1025M	80	TT1225M	80
Alabaster	TT625JA	100	TT825JA	100	TT1025JA	80	TT1225JA	80
Ultra White	TT625JUW	100	TT825JUW	100	TT1025JUW	80	TT1225JUW	80
J/Vanilla	TT625JV	100	TT825JV	100	TT1025JV	80	TT1225JV	80
J/White	TT625JW	100	TT825JW	100	TT1025JW	80	TT1225JW	80

Aluminium Round Edge Trim – 3metre



- Semi-quadrant finish for tile edge protection
- Designed for wall and external corner applications
- Creates an elegant look
- Available in a large range of anodised and powder coated colours
(Customised colours available on request)
- Also available in Brass

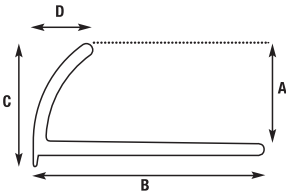

Size A	B	C	D
6mm	22mm	8.5mm	4.2mm
8mm	22mm	10.5mm	6.2mm
10mm	23mm	12.5mm	6.2mm
12mm	23mm	15mm	6.0mm



External Corner Trim – Horizontal



External Corner Trim – Vertical



Finishing Trim



Round Edge Corners



Round Edge Corners

Aluminium – 3metre

Colour		6mm Code	8mm Code	10mm Code	12mm Code	Pk Qty
	Matt Silver	ARE3.6MS	ARE3.8MS	ARE3.10MS	ARE3.12MS	20
	Brush Finish		ARE3.8BF	ARE3.10BF	ARE3.12BF	20
	Bright Silver	ARE3.6BS	ARE3.8BS	ARE3.10BS	ARE3.12BS	20
	Bright Gold	ARE3.6BG	ARE3.8BG	ARE3.10BG	ARE3.12BG	20
	White	ARE3.6W	ARE3.8W	ARE3.10W	ARE3.12W	20

Aluminium Round Edge Corners

Colour		6mm Code	8mm Code	10mm Code	12mm Code	Pk Qty
	Matt Silver	AREC6MS	AREC8MS	AREC10MS	AREC12MS	10
	Bright Silver	AREC6BS	AREC8BS	AREC10BS	AREC12BS	10

EDGE TRIM

Brass Round Edge Trim - 2.5metre



- Semi-quadrant finish for tile edge protection
- Designed for wall and external corner applications
- Creates an elegant look
- Also available in Aluminium

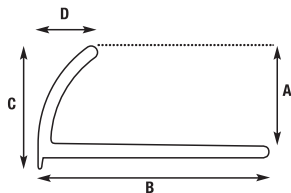

Size	A	B	C	D
6mm	22mm	22mm	7.5mm	4mm
8mm	22mm	22mm	9.5mm	6.7mm
10mm	23mm	23mm	11.5mm	7.5mm
12mm	23mm	23mm	14mm	6.7mm



External Corner Trim - Horizontal



External Corner Trim - Vertical



Finishing Trim

Brass - 2.5metre		6mm	8mm	10mm	12mm	Pk Qty
Colour		Code	Code	Code	Code	
	Brass	PABRE25.6	PABRE25.8	PABRE25.10	PABRE25.12	20

EDGE TRIM

Aluminium Square Edge Trim – 3metre



- Square finish trim for tile protection
- Decorative trim to create an elegant look
- Ideal for: external corners both vertical and horizontal, transition between carpet and tile and finishing trim on a vertical wall
- Comes in a range of anodised or powder coated colours
- Also available in PVC

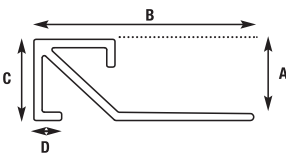

Size A	B	C	D
6.5mm	27mm	7.7mm	3mm
8.5mm	29mm	9.7mm	3mm
10.5mm	31mm	11.7mm	3mm
12.5mm	33mm	13.7mm	3mm



External Corner Trim – Horizontal



Corner Trim – Vertical



Transition



Finishing Trim



Square Edge Corners

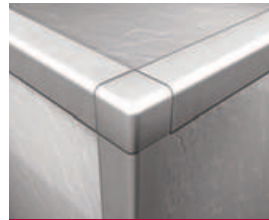

Square Edge Corners

Aluminium – 3metre		6mm	8mm	10mm	12mm	Pk Qty
Colour		Code	Code	Code	Code	
	Matt Silver	ASQE3.6MS	ASQE3.8MS	ASQE3.10MS	ASQE3.12MS	20
	Brush Finish		ASQE3.8BF	ASQE3.10BF	ASQE3.12BF	20
	Bright Silver	ASQE3.6BS	ASQE3.8BS	ASQE3.10BS	ASQE3.12BS	20
	Bright Gold	ASQE3.6BG	ASQE3.8BG	ASQE3.10BG	ASQE3.12BG	20
	White	ASQE3.6W	ASQE3.8W	ASQE3.10W	ASQE3.12W	20

Aluminium Square Edge Corners

		6mm	8mm	10mm	12mm	Pk Qty
Colour		Code	Code	Code	Code	
	Matt Silver	ASQEC6MS	ASQEC8MS	ASQEC10MS	ASQEC12MS	10
	Bright Silver	ASQEC6BS	ASQEC8BS	ASQEC10BS	ASQEC12BS	10

EDGE TRIM

PVC Square Edge Trim – 2.5metre



- Square finish trim for tile protection
- Decorative trim to create an elegant look
- Ideal for: external corners both vertical and horizontal, transition between carpet and tile and finishing trim on a vertical wall
- Also available in Aluminium

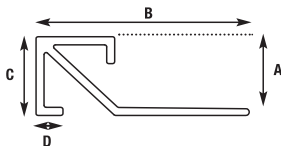

Size A	B	C	D
6.5mm	27mm	7.7mm	3mm
8.5mm	29mm	9.7mm	3mm
10.5mm	31mm	11.7mm	3mm



External Corner Trim – Horizontal

EDGE TRIM

PVC – 2.5metre		6mm	8mm	10mm	
Colour		Code	Code	Code	Pk Qty
	White	TSQ625W	TSQ825W	TSQ1025W	20
	Jasmine	TSQ625J	TSQ825J	TSQ1025J	20
	Vanilla	TSQ625V	TSQ825V	TSQ1025V	20

Aluminium L-Shape Trim



- Aluminium angle for tile edge protection
- Used where tile meets carpet, wooden floors etc.
- Creates an attractive finish if used on external corners
- Available in a wide range of sizes (Powder coated colours available on request)
- 1 metre lengths also available in anodised colours on request

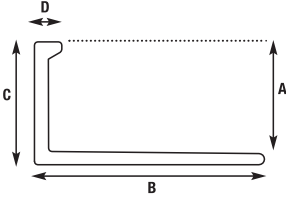

External Corner Trim – Horizontal

Size A	B	C	D
6mm	21mm	7.2mm	2.5mm
8mm	21mm	9.2mm	2.5mm
9mm	21mm	10.2mm	2.5mm
10mm	21mm	11.2mm	2.5mm
12.5mm	21mm	13.7mm	2.5mm
15mm	21mm	16.2mm	2.5mm
18.5mm	21mm	19.7mm	2.5mm
22mm	21mm	23.2mm	2.5mm



Corner Trim – Vertical



Transition



Finishing Trim

1metre

Colour	6mm	8mm	9mm	10mm	12.5mm	15mm	18.5mm	22mm	Pk Qty
	Code	Code	Code	Code	Code	Code	Code	Code	
Plain	ALA1.6	ALA1.8	ALA1.9	ALA1.10	ALA1.12	ALA1.15	ALA1.18	ALA1.22	10

3metre

Colour	6mm	8mm	9mm	10mm	12.5mm	15mm	18.5mm	22mm	Pk Qty
	Code	Code	Code	Code	Code	Code	Code	Code	
Plain	ALA3.6	ALA3.8	ALA3.9	ALA3.10	ALA3.12	ALA3.15	ALA3.18	ALA3.22	10
Matt Silver	ALA3.6MS	ALA3.8MS	ALA3.9MS	ALA3.10MS	ALA3.12MS	ALA3.15MS	ALA3.18MS	ALA3.22MS	10
Bright Silver	ALA3.6BS	ALA3.8BS	ALA3.9BS	ALA3.10BS	ALA3.12BS	ALA3.15BS	ALA3.18BS	ALA3.22BS	10
Bright Gold	ALA3.6BG	ALA3.8BG	ALA3.9BG	ALA3.10BG	ALA3.12BG	ALA3.15BG	ALA3.18BG	ALA3.22BG	10
Black		ALA3.8BK		ALA3.10BK	ALA3.12BK				10
White		ALA3.8W		ALA3.10W	ALA3.12W				10

EDGE TRIM

Unperforated Aluminium L-Shape Angle - 4metre

- Various size angles for commonly used self levelling compounds and screeds
- Other sizes and lengths available on request

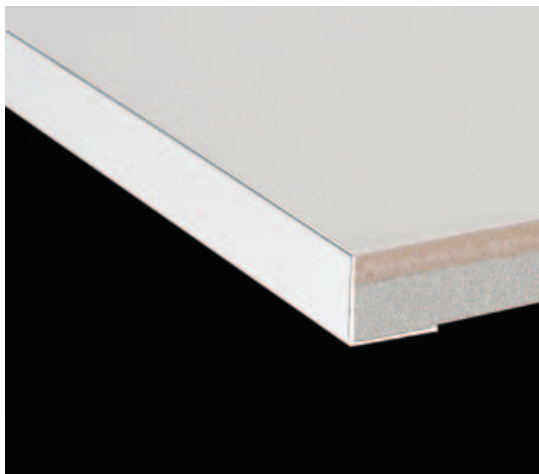

External L-Shape - Horizontal

Colour		20mm x 12mm x 1.5mm	20mm x 25mm x 1.5mm	20mm x 25mm x 3mm	40mm x 25mm x 1.5mm	40mm x 25mm x 3mm	Pk Qty
	Plain	PAA4.2012/1.5	PAA4.2025/1.5	PAA4.20253	PAA4.4025/1.5	PAA4.40253	10
	Gold		PAA4.2025G				10

Formable L-Shape Angle - 3metre

- Formable angle is ideal for tiles with a curve
- Can be used on floor and wall
- Can be used as an edge protection of tiled floors
- Available in 3 sizes

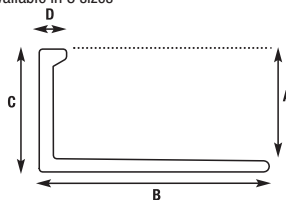

Size A	B	C	D
8mm	21mm	9.2mm	2.5mm
10mm	21mm	11.2mm	2.5mm
12.5mm	21mm	13.7mm	2.5mm



Formable L-Shape Angle

Colour		8mm	10mm	12mm	Pk Qty
		Code	Code	Code	
	Plain	ALA3.8F	ALA3.10F	ALA3.12F	10

Brass L-Shape Trim



- Brass angle for tile edge protection
- Used where tile meets carpet, wooden floors etc.
- Creates an attractive finish if used on external corners
- Available in a wide range of sizes (Powder coated colours available on request)
- 1 metre lengths ideal for standard doorways

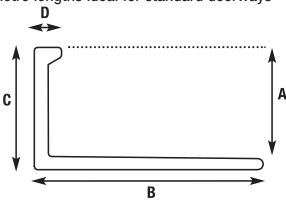

External Corner Trim – Horizontal

Size A	B	C	D
8mm	21mm	9.3mm	2.5mm
10mm	21mm	11.3mm	2.5mm
12.5mm	21mm	14.1mm	2.5mm
15mm	21mm	16.6mm	2.5mm
18.5mm	21mm	20.1mm	2.5mm
22mm	21mm	24.1mm	2.5mm



Corner Trim – Vertical



Transition

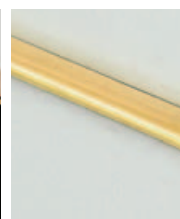

Finishing Trim

1metre		8mm	10mm	12.5mm	15mm	18.5mm	22mm	
Colour		Code	Code	Code	Code	Code	Code	Pk Qty
	Plain	PMB1.8	PMB1.10	PMB1.12.5	PMB1.15	PMB1.18.5	PMB1.22	10

3metre		8mm	10mm	12.5mm	15mm	18.5mm	22mm	
Colour		Code	Code	Code	Code	Code	Code	Pk Qty
	Plain	PMB3.8	PMB3.10	PMB3.12.5	PMB3.15	PMB3.18.5	PMB3.22	10

EDGE TRIM

Stainless Steel Round Edge Trim - 2.5metre



- Stainless steel semi-quadrant round edge creates an elegant decorative external corner
- Can be used on: stairs, bath hobs, external corners both horizontal or vertical and finishing trim on a wall
- Available in both 304 Grade and Marine Grade 316L Stainless Steel
- Available in 4 sizes

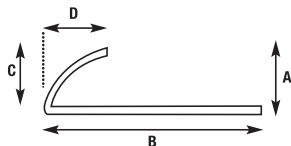

Size A	B	C	D
6mm	27mm	6.8mm	4mm
8mm	27mm	8.8mm	5mm
10mm	27mm	10.8mm	6mm
12mm	27mm	12.8mm	7mm



External Corner Trim – Horizontal



External Corner Trim – Vertical



Finishing Trim

Colour		6mm	8mm	10mm	12mm	Pk Qty
		Code	Code	Code	Code	
	Stainless Steel (304 Grade)	SRE406	SRE408	SRE410	SRE412	20
	Stainless Steel (316L Grade)	SRE1606	SRE1608	SRE1610	SRE1612	20

Stainless Steel L-Shape Trim - 3metre



- Stainless steel L-shape angle available in 3metre lengths
- Creates an elegant decorative finish for: stairs, external corners both horizontal and vertical, transition between carpet and tile and finishing trim on a wall
- Available in both 304 Grade and Marine Grade 316L Stainless Steel
- Available in 4 sizes

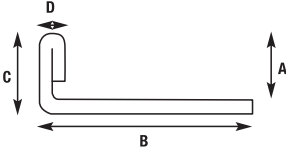

External Corner Trim – Horizontal

Size A	B	C	D
8mm	27mm	8.8mm	2mm
10mm	27mm	10.8mm	2mm
12mm	27mm	12.8mm	2mm
22mm	27mm	22.8mm	2mm



Corner Trim – Vertical



Transition



Finishing Trim

Colour		8mm	10mm	12mm	22mm	Pk Qty
		Code	Code	Code	Code	
	Stainless Steel (304 Grade)	SSE408	SSE410	SSE412	SSE422	20
	Stainless Steel (316L Grade)	SSE1608	SSE1610	SSE1612	SSE1622	20

EDGE TRIM

Stainless Steel Square Edge Trim – 2.5metre



- Stainless steel square edge is available in 3metre lengths
- Creates an elegant decorative modern finish for: stairs, external corners both horizontal and vertical, transition between carpet and tile and finishing trim on a wall
- Available in both 304 Grade and Marine Grade 316L Stainless Steel

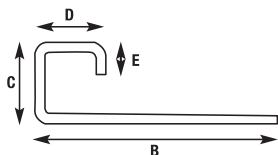

Size	A	B	C	D	E
8mm		27mm	8.8mm	8mm	4mm
10mm		27mm	10.8mm	8mm	4mm
12mm		27mm	12.8mm	8mm	4mm



External Corner Trim – Horizontal



Corner Trim – Vertical



Transition

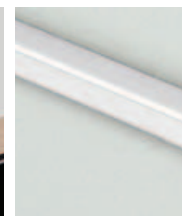

Finishing Trim

Colour		8mm	10mm	12mm	Pk Qty
		Code	Code	Code	
	Stainless Steel (304 Grade)	SSQ408	SSQ410	SSQ412	20
	Stainless Steel (316L Grade)	SSQ1608	SSQ1610	SSQ1612	20

EDGE TRIM

TRANSITION TRIM

DTA Transition Trims are designed to provide a smooth transition between tile and floor coverings or finished concrete at lower elevations. They are also designed to provide a smooth transition between two different materials of the same height.

Aluminium Flat Listello Trim

- Ideal for most domestic or commercial applications
- Available in a range of anodised and powder coated colours (Customised colours available on request)
- Creates a modern contemporary look without the expense of ceramic Listello Tiles

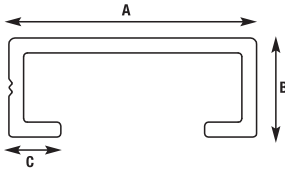

Size A	B	C
10mm	8mm	3.2mm
20mm	8mm	4.2mm



TRANSITION TRIM

2metre		10mm x 2m	20mm x 2m	Pk Qty
Colour		Code	Code	
	Plain	ABT2.10	ABT2.20	10
	Matt Silver	ABT2.10MS	ABT2.20MS	10
	Bright Silver	ABT2.10BS	ABT2.20BS	10
	Bright Gold	ABT2.10BG	ABT2.20BG	10

3metre		10mm x 2m	20mm x 2m	Pk Qty
Colour		Code	Code	
	Bright Silver	ABT3.10BS	ABT3.20BS	10

Aluminium Transition Edge Trim



- Transition step edge available in 1metre and 3metre lengths
- 30 degree incline allows for a gradual transition from either concrete, wood floor or vinyl to protect the edge of the tile
- Ideal for domestic or commercial application
- Available in 5 sizes and 3 different colours (Customised colours are available on request)
- Profiles 12.5mm and larger have a support leg for extra strength

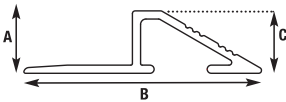

Size A	B	C	D
8mm	40mm	5.5mm	20mm
10mm	42mm	5.5mm	23.7mm

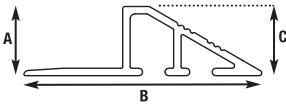

Size A	B	C	D
12.5mm	48mm	5.5mm	28mm
16mm	54mm	5.5mm	34mm
18.5mm	58mm	5.5mm	38.5mm



TRANSITION TRIM

1metre		8mm	10mm	12mm	16mm	18mm	Pk Qty
Colour		Code	Code				
	Bright Silver	ATSE1.8	ATSE1.10				10

3metre		8mm	10mm	12mm	16mm	18mm	Pk Qty
Colour		Code	Code				
	Plain	ATSE3.8	ATSE3.10	ATSE3.12	ATSE3.16	ATSE3.18	10
	Matt Silver	ATSE3.8MS	ATSE3.10MS	ATSE3.12MS	ATSE3.16MS	ATSE3.18MS	10
	Bright Silver	ATSE3.8BS	ATSE3.10BS	ATSE3.12BS	ATSE3.16BS	ATSE3.18BS	10

Aluminium Step Edge Trim - 3metre

- Tile in safety step edge trim
- Ideal for commercial application
- Available in a range of anodised and powder coated colours (Customised colours are available on request)
- Rippled surface for extra grip

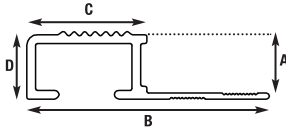

Size A	B	C	D
8mm	41mm	20mm	9mm
10mm	41mm	20mm	11mm
12.5mm	41mm	20mm	14mm



Colour	8mm Code	10mm Code	12.5mm Code	Pk Qty
Plain	ASE3.8	ASE3.10	ASE3.12	10
Matt Silver	ASE3.8MS	ASE3.10MS	ASE3.12MS	10
Bright Silver	ASE3.8BS	ASE3.10BS	ASE3.12BS	10
Matt Bronze	ASE3.8MBR	ASE3.10MBR	ASE3.12MBR	10

Aluminium Dividing Trim - 2.5metre

- The dividing trim is designed to provide transitions between existing same-height, hard-surface floor coverings
- Applications include ceramic tile or natural stone, parquet flooring, concrete pavers, laminate etc.
- Primarily used in retrofit applications
- Available in 2 colours

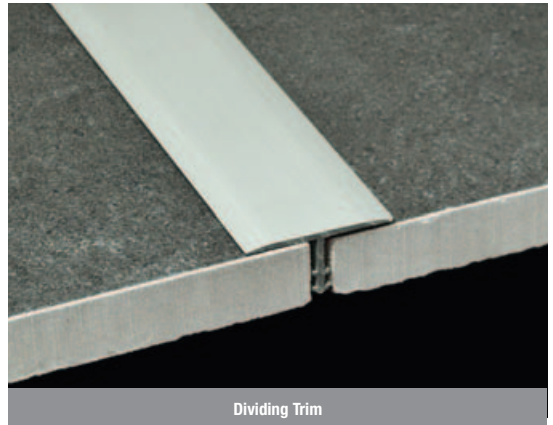
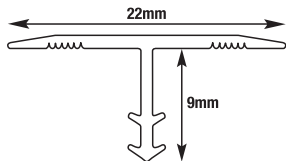

Colour	Size	Code	Pk Qty
Plain	22mm x 2.5m	ADS25.22	5
Matt Silver	22mm x 2.5m	ADS25.22MS	5

COMMERCIAL TRIM

DTA Commercial Trims are made from a high strength alloy for increased durability in high traffic areas.

The designer range enables an elegant contemporary look, while still providing maximum tile protection.

Commercial Trims are available in Aluminium and Stainless Steel finishes.

PVC Movement Joints - 2.5metre

- This is a co extruded PVCU movement joint
- Allows movement in larger tiled floors
- Application is for internal use in a domestic area

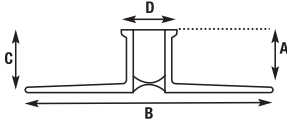

Size	A	B	C	D
8mm	48mm	9.2mm	9mm	
10mm	48mm	11.2mm	9.5mm	
13mm	48mm	13.2mm	9.5mm	



Colour		8mm Code	10mm Code	13mm Code	Pk Qty
	Grey	EJT8GREY	EJT10GREY	EJT13GREY	20
	Beige	EJT8BEIGE	EJT10BEIGE	EJT13BEIGE	20
	Black	EJT8BLACK	EJT10BLACK	EJT13BLACK	20

PVC Screed Movement Joints - 2.5metre

- PVC screed joint
- Available in 2.5metre lengths
- For use in larger tiled areas where screed has been used
- Available in 3 colours

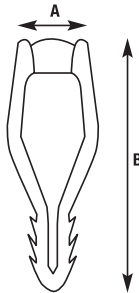

Size	A	B
9mm		30mm



Colour		30mm Code	Pk Qty
	Grey	EJ30GREY	20
	Beige	EJ30BEIGE	20
	Black	EJ30BLACK	20

Aluminium and Brass Movement Joints - 3metre

- Prefabricated movement joint designed to allow for expansion and contraction of floor tiles
- Polyurethane insert available in both grey and black. Other colours available on request
- Shore hardness of 45
- Aluminium angles protect edge of tiles from damage
- Installed over construction joints
- Conforms with Australian Standard AS3958

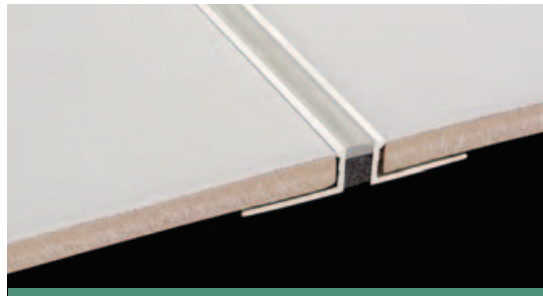

Aluminium Movement Joints

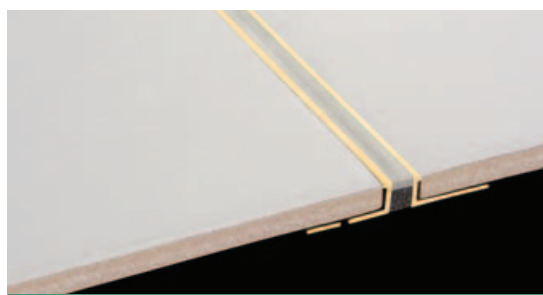

Brass Movement Joints

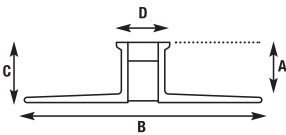

Size A	B	C	D (6mm)	D (10mm)
8mm	52mm	9.2mm	11mm	15mm
10mm	52mm	11.2mm	11mm	15mm
12.5mm	52mm	13.7mm	11mm	15mm
15mm	52mm	16.2mm	11mm	15mm
18.5mm	52mm	19.7mm	11mm	15mm
22mm	52mm	22.5mm	11mm	15mm

Aluminium

6mm wide

Colour		8mm	10mm	12mm	15mm	18mm	22mm	Pk Qty
Code		Code	Code	Code	Code	Code	Code	
Grey		PACG3A8X6G	PACG3A10X6G	PACG3A12X6G	PACG3A15X6G	PACG3A18X6G	PACG3A22X6G	10
Black		PACG3A8X6BL	PACG3A10X6BL	PACG3A12X6BL	PACG3A15X6BL	PACG3A18X6BL	PACG3A22X6BL	10

10mm wide

Colour		8mm	10mm	12mm	15mm	18mm	22mm	Pk Qty
Code		Code	Code	Code	Code	Code	Code	
Grey		PACG3A8X10G	PACG3A10X10G	PACG3A12X10G	PACG3A15X10G	PACG3A18X10G	PACG3A22X10G	10
Black		PACG3A8X10BL	PACG3A10X10BL	PACG3A12X10BL	PACG3A15X10BL	PACG3A18X10BL	PACG3A22X10BL	10

Brass

6mm wide

Colour		8mm	10mm	12mm	15mm	18mm	22mm	Pk Qty
Code		Code	Code	Code	Code	Code	Code	
Grey		PACG3B8X6G	PACG3B10X6G	PACG3B12X6G	PACG3B15X6G	PACG3B18X6G	PACG3B22X6G	10
Black		PACG3B8X6BL	PACG3B10X6BL	PACG3B12X6BL	PACG3B15X6BL	PACG3B18X6BL	PACG3B22X6BL	10

10mm wide

Colour		8mm	10mm	12mm	15mm	18mm	22mm	Pk Qty
Code		Code	Code	Code	Code	Code	Code	
Grey		PACG3B8X10G	PACG3B10X10G	PACG3B12X10G	PACG3B15X10G	PACG3B18X10G	PACG3B22X10G	10
Black		PACG3B8X10BL	PACG3B10X10BL	PACG3B12X10BL	PACG3B15X10BL	PACG3B18X10BL	PACG3B22X10BL	10

COMMERCIAL TRIM

Stainless Steel Movement Joints - 3metre



- Prefabricated movement joint allows for the expansion and contraction of floor tiles
- Polyurethane insert comes in grey and black (Other colours are available on request)
- Shore hardness of 45
- Stainless Steel Angle Grade 304 has been used
- Marine Grade 316L is also available on request
- Stainless Steel angles protects the edge of tiles against damage

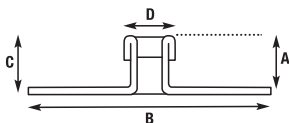

Size	A	B	C	D (6mm)	D (10mm)
8mm	8mm	52mm	9.2mm	10mm	14mm
10mm	10mm	52mm	11.2mm	10mm	14mm
12mm	12mm	52mm	13.7mm	10mm	14mm



Movement Joints

6mm wide		8mm	10mm	12mm	Pk Qty
Colour		Code	Code	Code	
	Grey	CGE3S48X6G	CGE3S410X6G	CGE3S412X6G	10
	Black	CGE3S48X6BL	CGE3S410X6BL	CGE3S412X6BL	10

10mm wide		8mm	10mm	12mm	Pk Qty
Colour		Code	Code	Code	
	Grey	CGE3S48X10G	CGE3S410X10G	CGE3S412X10G	10
	Black	CGE3S48X10BL	CGE3S410X10BL	CGE3S412X10BL	10

Commercial Aluminium Stair Tread

- Utilises high strength, heat treated aluminium alloy for extra durability
- Heavy duty design with anti slip tread for commercial stairways
- Suitable for both indoor and outdoor applications
- UV and water resistant
- Complies with Safety Standard AS/NZ 4586
- Available in 1 metre and 3 metre lengths

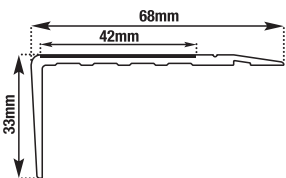

Stair Tread

Colour	Size	Code	Pk Qty
Matt Silver	1m x 68mm	AST1.68MS	10
Matt Silver	3m x 68mm	AST3.68MS	10
Matt Silver	1m x 68mm WITH ADHESIVE	AST1.68MSA	10

Commercial Aluminium Stair Tread with Illumination

- Utilises high strength, heat treated aluminium alloy for extra durability
- Heavy duty design with anti slip tread for commercial stairways
- The illuminated strip allows for illumination of the trim when lights have been turned off
- Self adhesive for easy installation
- 30 minutes in the light allows for 7 hours of illumination
- Suitable for both indoor and outdoor applications
- UV and water resistant
- Complies with Safety Standard AS/NZ 4586
- Available in 1 metre and 3 metre lengths

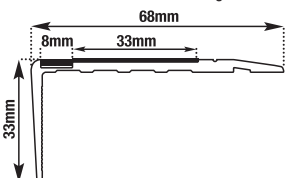

Stair Tread with Illumination

Colour	Size	Code	Pk Qty
Matt Silver	1m x 68mm	AST1.68MSAI	10
Matt Silver	3m x 68mm	AST3.68MSAI	10

COMMERCIAL TRIM

Aluminium All Purpose Cove Trim – 3.6metre

- Cove trim for wall and floor
- Installed after tiles have been laid
- 50mm radius for easy cleaning.
(Conforms with Australian Standard for hygiene in kitchens and toilets)
- Available in a range of anodised and powder coated colours
(Customised colours are available on request)

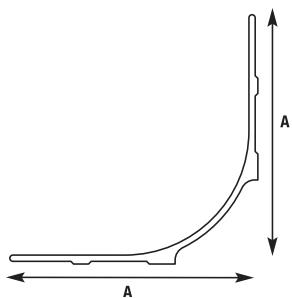

Size	A
	50mm



Cove Trim

Colour	Code	Pk Qty
Plain	PAAPC60PL36	10
Matt Silver	PAAPC60MS36	10
Bright Silver	PAAPC60BS36	10
White	PAAPC60W36	10

COMMERCIAL TRIM

Aluminium Cove Trim - 3.6metre



- Cove trim for wall and floor tiles
- Creates a smooth transition between wall and floor
- 25.4mm radius for easy cleaning
(Conforms with the Australian Standards for hygiene in kitchens and toilets)
- Available in a range of anodised and powder coated colours
(Customised colours are available on request)

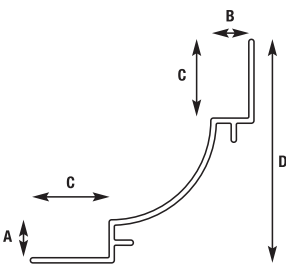

Size A	B	C	D
8mm	10mm	22mm	60mm
10mm	10mm	22mm	60mm



Cove Trim

Colour		10mm x 8mm x 3.6m	10mm x 10mm x 3.6m	Pk Qty
		Code	Code	
	Plain	PACT36PL10X8	PACT36PL10X10	10
	Matt Silver	PACT36MS10X8	PACT36MS10X10	10
	Bright Silver	PACT36BS10X8	PACT36BS10X10	10
	White	PACT36W10X8	PACT36W10X10	10

COMMERCIAL TRIM

Aluminium Cove Trim Corners

- Internal and external corners to suit both the 10mm x 8mm cove and the 10mm x 10mm cove



- Available in a range of anodised and powder coated colours (Customised colours available on request)

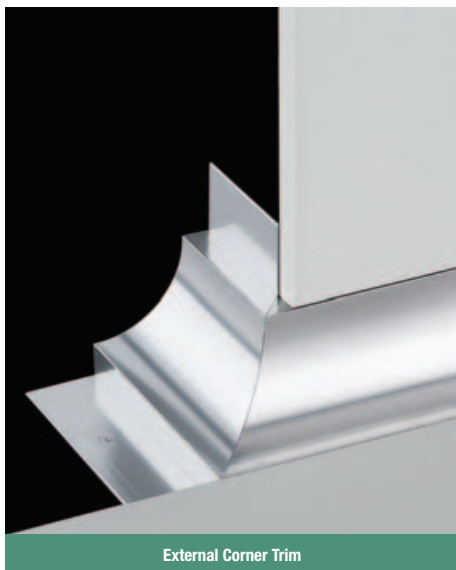

External Corner Trim



Internal Corner Trim

External		10mm x 8mm	10mm x 10mm	
Colour		Code	Code	Pk Qty
	Plain	PAECPL10X8	PAECPL10X10	5
	Matt Silver	PAECMS10X8	PAECMS10X10	5
	Bright Silver	PAECBS10X8	PAECBS10X10	5
	White	PAECW10X8	PAECW10X10	5

Internal		10mm x 8mm	10mm x 10mm	
Colour		Code	Code	Pk Qty
	Plain	PAICPL10X8	PAICPL10X10	5
	Matt Silver	PAICMS10X8	PAICMS10X10	5
	Bright Silver	PAICBS10X8	PAICBS10X10	5
	White	PAICW10X8	PAICW10X10	5

Balcony Trim and Corners - 3metre

- Balcony trim has been designed to stop watermarks forming on balcony fascias
- The lip design at the bottom of the trim stops any water from running down the fascia
- Ideal for domestic or commercial applications
- Available in 3metre lengths with internal and external corners
- The patented joining system makes for easy installation



Balcony Trim

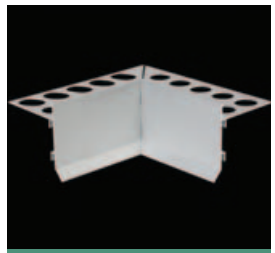
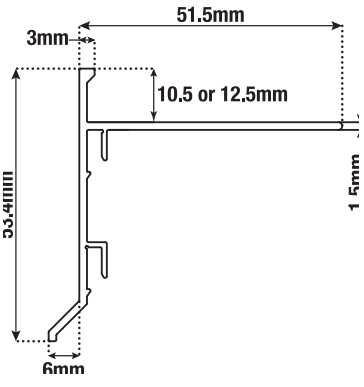

Internal Corner Trim

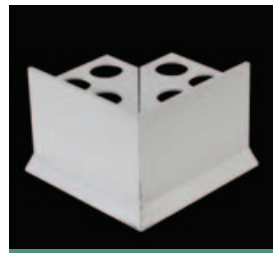

External Corner Trim

10mm		Trim 3m x 10mm		Internal Trim - 10mm		External Trim - 10mm	
Colour		Code	Pk Qty	Code	Pk Qty	Code	Pk Qty
	Plain	ALBT3.10	10	ALBTIC10	5	ALBTEC10	5
	Matt Silver	ALBT3.10MS	10	ALBTIC10MS	5	ALBTEC10MS	5

12mm		Trim 3m x 10mm		Internal Trim - 10mm		External Trim - 10mm	
Colour		Code	Pk Qty	Code	Pk Qty	Code	Pk Qty
	Plain	ALBT3.12	10	ALBTIC12	5	ALBTEC12	5
	Matt Silver	ALBT3.12MS	10	ALBTIC12MS	5	ALBTEC12MS	5

Joiners Available

Colour	Code	Pk Qty
	ALBTJ	5

COMMERCIAL TRIM



MERCHANDISING



MERCHANDISING

DTA offer our resellers a number of versatile display options. We have display stands that are suitable for wall mounting or floor display. Regardless of the size of your retail area, a DTA Trim stand is the best way to display and maintain your stock levels. A DTA Trim Stand enables customers to easily compare and select the best trim for their project. In larger stores, trims can be segmented and displayed on multiple stands, allowing separate display of metals and PVC. Please call your DTA representative to discuss the most suitable package for your retail needs.

Angle Merchandising Stand 3metre

Code: **PBAS3**

Pk Qty: 1



- Neatly and efficiently displays 3metre metal trims in stores
- Can be individually tailored to suit store requirements

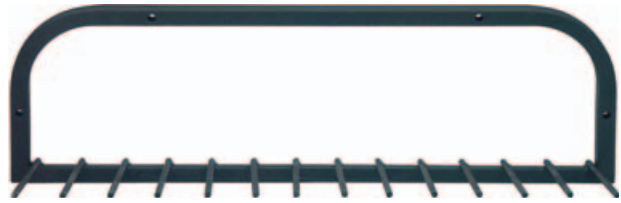

Angle Merchandising Stand 1metre

Code: **PBAS1**

Pk Qty: 1



- Neatly and efficiently displays 1metre metal trims in stores
- Can be individually tailored to suit store requirements

Trim Merchandising Stand 28 Hooks

- Neatly and efficiently displays PVC and metal trims in stores
- Can be individually tailored to suit store requirements
- Light included in header sign



Code	Product	Pk Qty
DTATD	Stand	1
DTATDH	Hooks	1

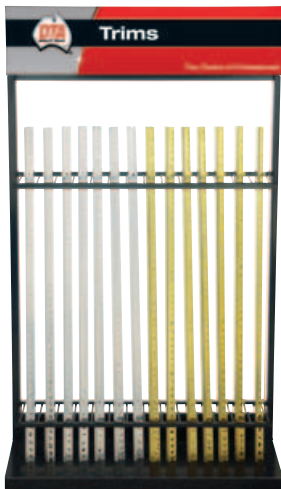



www.dta-aus.com.au

The Choice of Professionals

Head Office – VICTORIA

ABN 26 007 291 054

P 1800 505 045

F 03 9781 9788

E sales@dta-aus.com.au

P.O. Box 318, Patterson Lakes 3197

6 Ashley Park Drive, Chelsea Heights 3196

NEW SOUTH WALES

P 1800 505 045

F 1800 834 200

E sales@dta-aus.com.au

38 Mount Erin Road, Campbelltown 2560

WESTERN AUSTRALIA

P 08 9475 0633

F 08 9475 0644

E dtawa@dta-aus.com.au

Unit 4/130 Francisco Street, Belmont 6104

QUEENSLAND

P 1800 505 045

F 07 3883 6066

E dtaqld@dta-aus.com.au

7 Hinkler Court, Brendale 4500

SOUTH AUSTRALIA

P 1800 505 045

F 03 9781 9788

E sales@dta-aus.com.au

CHINA

E sales@dta-aus.com.au

No 58 Guang Le Road,

Guang Ming Industrial Area, Nan Qiao Town,

Fengxian District, Shanghai China

DTA reserve the right to change product specifications without notice. Products may vary from pictures shown.

Colours shown are as close as possible to actual trim colours.

Please note: due to limitations of the printing process, printed colours may not represent the true colour.