



castella™
architectural cabinetware

Introducing our latest range of high quality architectural hardware designed to complement Australia's fine homes and buildings. We invite you to browse our extensive collection and be assured that our constant product development and commitment to quality provides premium architectural fittings for your project.

castella[™]
architectural cabinetware

castella[™]
architectural cabinetware



antique 2



contemporary 6



designer 22



french provincial 34



metropolitan 38



retro 50



veneto collection 58

antique



	CODE	CENTRE	LENGTH	PROJECTION	FINISH
1	08.064.14	64mm	104mm	24mm	Pewter
2	08.064.01	64mm	104mm	24mm	Antique Black
3	08.064.03	64mm	104mm	24mm	Antique Brass



	CODE	CENTRE	LENGTH	PROJECTION	FINISH
1	10.076.03	76mm	140mm	25mm	Antique Brass
2	10.076.01	76mm	140mm	25mm	Antique Black
3	10.076.14	76mm	140mm	25mm	Pewter



	CODE	DIAMETER	PROJECTION	FINISH	CODE	DIAMETER	PROJECTION	FINISH	
1	56.034.03	34mm	25mm	Antique Brass	4	84.070.16	70mm	47mm	Pewter Crackle/Pewter
2	56.034.01	34mm	25mm	Antique Black	5	84.070.17	70mm	47mm	Coffee Crackle/Antique Brass
3	56.034.14	34mm	25mm	Pewter	6	83.035.16	35mm	33mm	Pewter Crackle/Pewter
					7	83.035.17	35mm	33mm	Coffee Crackle/Antique Brass



contemporary



	CODE	CENTRE	LENGTH	PROJECTION	FINISH
1	11.128.10	128mm	149mm	25mm	Brushed Nickel
2	11.096.10	96mm	115mm	23mm	Brushed Nickel
3	11.128.06	128mm	149mm	25mm	Bright Chrome
4	11.096.06	96mm	115mm	23mm	Bright Chrome

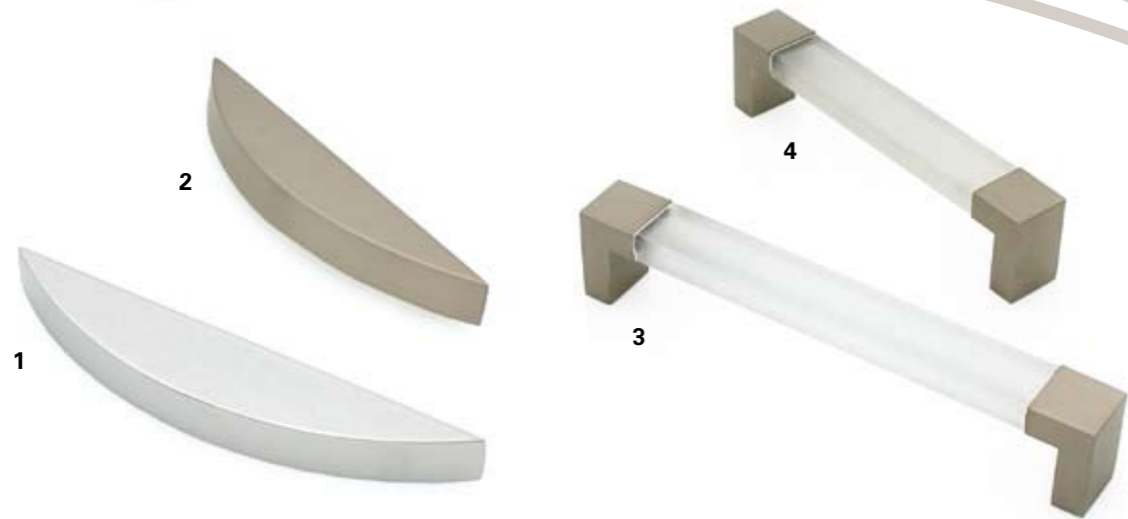

	CODE	CENTRE	LENGTH	PROJECTION	FINISH
1	14.096.06	96mm	127mm	22mm	Bright Chrome
2	14.096.10	96mm	127mm	22mm	Brushed Nickel
3	13.160.10	160mm	170mm	31mm	Translucent Acrylic/Brushed Nickel
4	13.128.10	128mm	138mm	31mm	Translucent Acrylic/Brushed Nickel

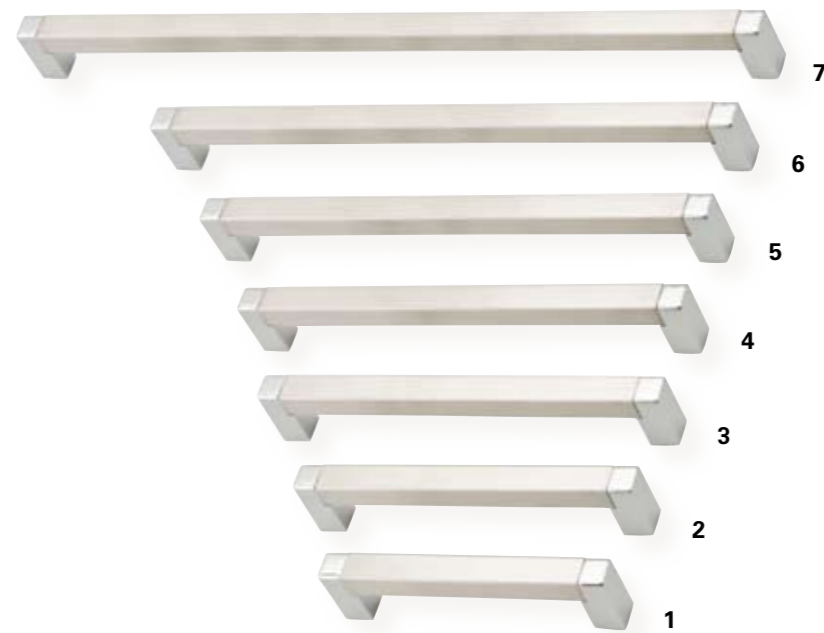

	CODE	CENTRE	LENGTH	PROJECTION	FINISH
1	25.128.07	128	142	35	Satin Stainless Steel/Chrome
2	25.160.07	160	174	35	Satin Stainless Steel/Chrome
3	25.224.07	224	238	35	Satin Stainless Steel/Chrome
4	25.288.07	288	302	35	Satin Stainless Steel/Chrome
5	25.352.07	352	366	35	Satin Stainless Steel/Chrome
6	25.416.07	416	430	35	Satin Stainless Steel/Chrome
7	25.544.07	544	558	35	Satin Stainless Steel/Chrome



	CODE	CENTRE	LENGTH	PROJECTION	FINISH
1	36.128.07	128	140	32	Satin Stainless Steel
2	36.160.07	160	172	32	Satin Stainless Steel
3	36.224.07	224	236	32	Satin Stainless Steel
4	36.288.07	288	300	32	Satin Stainless Steel
5	36.352.07	352	364	32	Satin Stainless Steel
6	36.416.07	416	428	32	Satin Stainless Steel



	CODE	CENTRE	LENGTH	PROJECTION	FINISH
1	32.096.10	96mm	102mm	26mm	Brushed Nickel
2	32.128.10	128mm	134mm	26mm	Brushed Nickel
3	32.160.10	160mm	166mm	26mm	Brushed Nickel
4	32.224.10	224mm	230mm	26mm	Brushed Nickel
5	32.288.10	288mm	294mm	26mm	Brushed Nickel
*	32.352.10	352mm	358mm	26mm	Brushed Nickel



	CODE	CENTRE	LENGTH	PROJECTION	FINISH
1	41.160.11	160mm	180mm	23mm	Aluminium
2	41.128.11	128mm	158mm	23mm	Aluminium
3	41.096.11	96mm	116mm	23mm	Aluminium
4	41.064.11	64mm	84mm	23mm	Aluminium

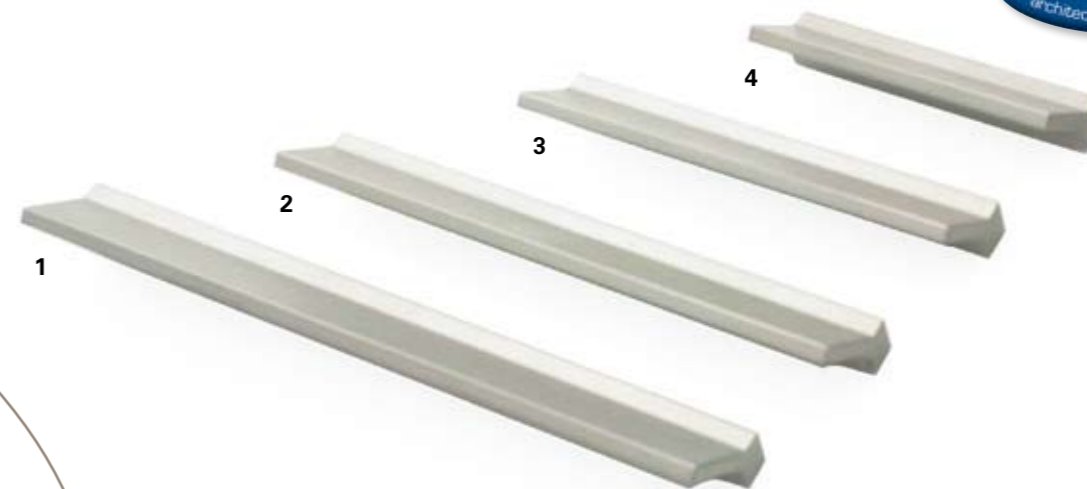

	CODE	CENTRE	LENGTH	PROJECTION	FINISH
1	40.160.11	160mm	170mm	23mm	Aluminium
2	40.128.11	128mm	138mm	23mm	Aluminium
3	40.096.11	96mm	105mm	23mm	Aluminium
4	40.064.11	64mm	74mm	23mm	Aluminium

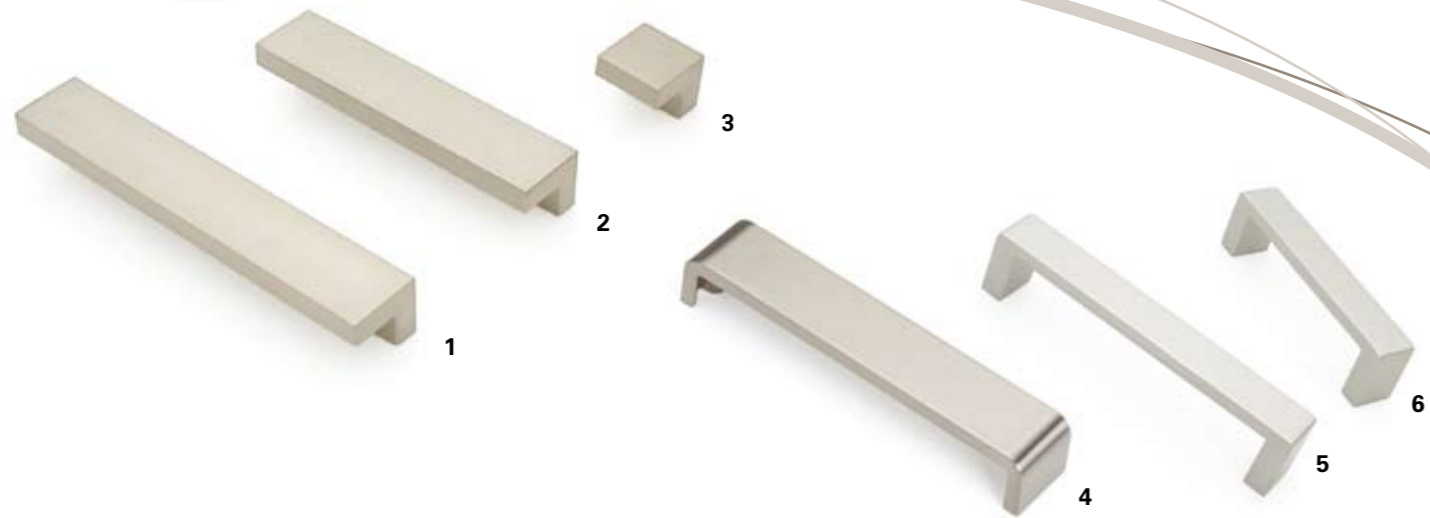

	CODE	CENTRE	LENGTH	PROJECTION	FINISH
1	55.128.10	128mm	143x 25mm	21mm	Brushed Nickel
2	55.096.10	96mm	111 x 25mm	21mm	Brushed Nickel
3	55.025.10	16mm	25 x 25mm	21mm	Brushed Nickel
4	34.160.10	160mm	170 x 33mm	27mm	Brushed Nickel
5	42.128.11	128mm	138mm	29mm	Aluminium
6	42.096.11	96mm	106mm	29mm	Aluminium

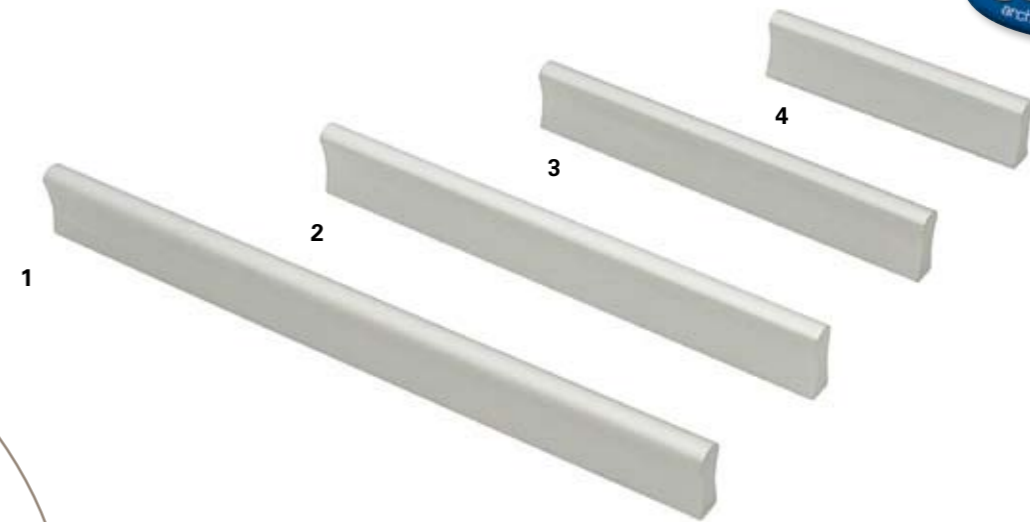

	CODE	CENTRE	LENGTH	PROJECTION	FINISH
1	43.160.11	160mm	200mm	20mm	Aluminium
2	43.128.11	128mm	151mm	20mm	Aluminium
3	43.096.11	96mm	120mm	20mm	Aluminium
4	43.064.11	64mm	80mm	20mm	Aluminium

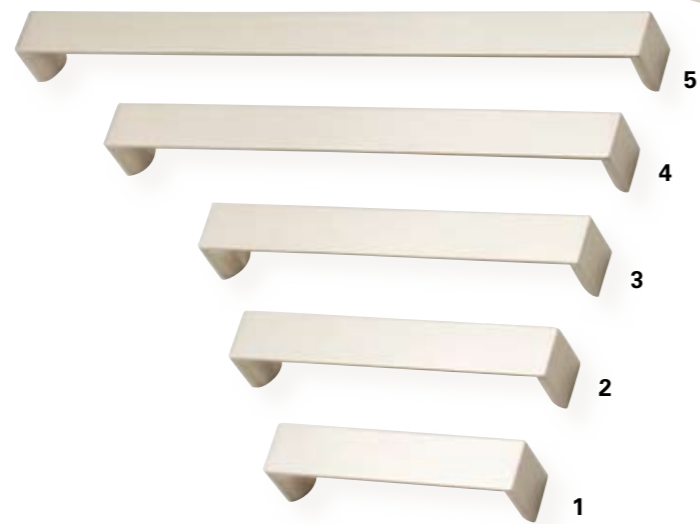

	CODE	CENTRE	LENGTH	PROJECTION	FINISH
1	66.096.10	96mm	106mm	25mm	Brushed Nickel
2	66.128.10	128mm	138mm	25mm	Brushed Nickel
3	66.160.10	160mm	170mm	25mm	Brushed Nickel
4	66.224.10	224mm	234mm	25mm	Brushed Nickel
5	66.288.10	288mm	298mm	25mm	Brushed Nickel

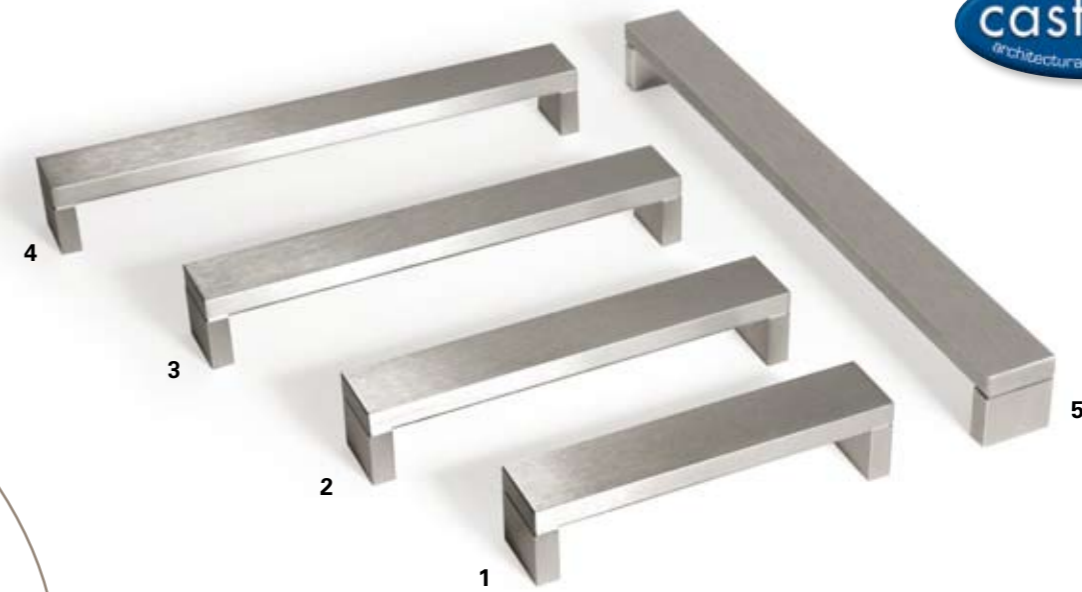

	CODE	CENTRE	LENGTH	PROJECTION	FINISH		CODE	CENTRE	LENGTH	PROJECTION	FINISH
1	33.128.10	128mm	136mm	32mm	Dull Brushed Stainless	*	33.480.10	480mm	488mm	32mm	Dull Brushed Stainless
2	33.160.10	160mm	168mm	32mm	Dull Brushed Stainless	*	33.512.10	512mm	520mm	32mm	Dull Brushed Stainless
3	33.224.10	224mm	232mm	32mm	Dull Brushed Stainless	*	33.608.10	608mm	616mm	32mm	Dull Brushed Stainless
4	33.288.10	288mm	296mm	32mm	Dull Brushed Stainless	*	33.736.10	736mm	744mm	32mm	Dull Brushed Stainless
5	33.352.10	352mm	360mm	32mm	Dull Brushed Stainless						

Width: 28mm *Not pictured

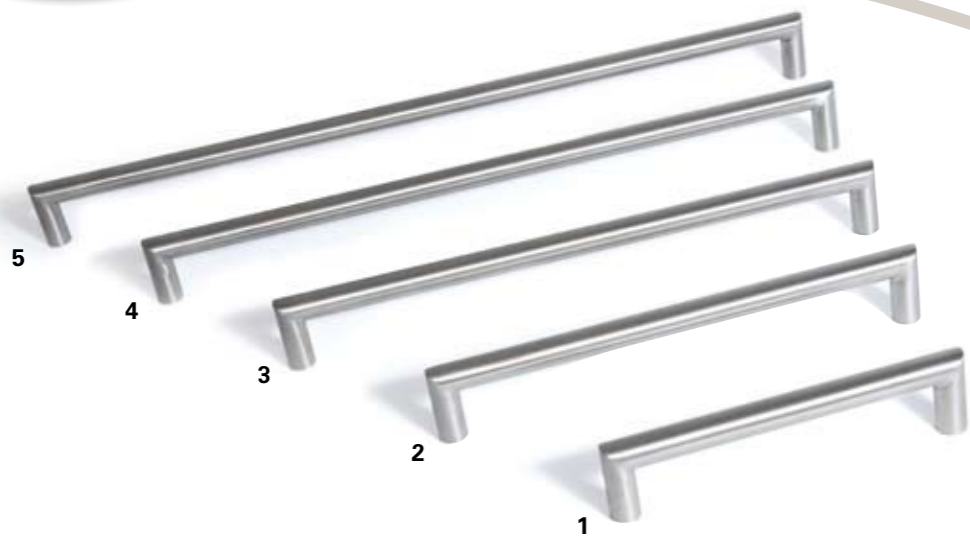

	CODE	CENTRE	LENGTH	PROJECTION	FINISH
*	24.096.07	96mm	108mm	34mm	Stainless Steel
1	24.128.07	128mm	140mm	34mm	Stainless Steel
2	24.160.07	160mm	172mm	34mm	Stainless Steel
3	24.224.07	224mm	236mm	34mm	Stainless Steel
4	24.288.07	288mm	300mm	34mm	Stainless Steel
5	24.352.07	352mm	364mm	34mm	Stainless Steel

Diameter: 12mm * Not Pictured



	CODE	CENTRE	LENGTH	PROJECTION	FINISH
1	48.128.07	128mm	148mm	34mm	Stainless Steel
2	48.160.07	160mm	180mm	34mm	Stainless Steel
3	48.192.07	192mm	212mm	34mm	Stainless Steel
4	48.288.07	288mm	308mm	34mm	Stainless Steel
5	48.320.07	320mm	340mm	34mm	Stainless Steel
*	48.384.07	384mm	404mm	34mm	Stainless Steel

	CODE	CENTRE	LENGTH	PROJECTION	FINISH
*	48.480.07	480mm	500mm	34mm	Stainless Steel
*	48.640.07	640mm	660mm	34mm	Stainless Steel
*	48.788.07	768mm	788mm	34mm	Stainless Steel

Diameter: 14mm *Not Pictured



	CODE	CENTRE	LENGTH	PROJECTION	FINISH
1	44.160.10	160mm	208mm	33mm	Glass/Dull Brushed Stainless
2	44.048.10	48mm	48mm	33mm	Glass/Dull Brushed Stainless





designer



	CODE	CENTRE	LENGTH	PROJECTION	FINISH
1	03.128.15	128mm	165mm	32mm	Satin Chrome
2	03.128.04	128mm	165mm	32mm	Matt Black
3	02.096.09	96mm	111mm	22mm	Black Nickel
4	02.096.15	96mm	111mm	22mm	Satin Chrome
5	02.096.06	96mm	111mm	22mm	Bright Chrome

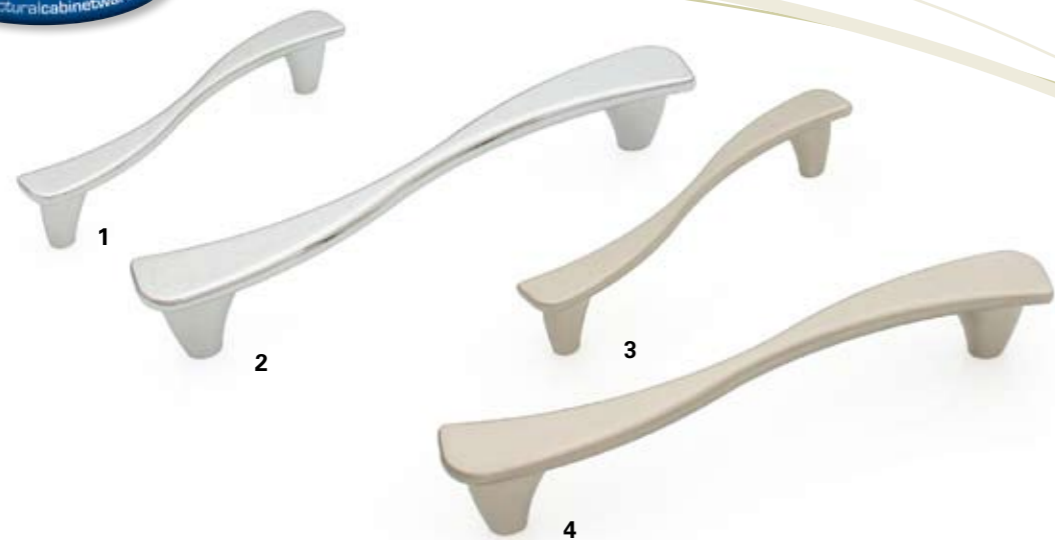

	CODE	CENTRE	LENGTH	PROJECTION	FINISH
1	12.096.06	96mm	114mm	21mm	Bright Chrome
2	12.128.06	128mm	152mm	25mm	Bright Chrome
3	12.096.10	96mm	114mm	21mm	Brushed Nickel
4	12.128.10	128mm	152mm	25mm	Brushed Nickel



	CODE	CENTRE	LENGTH	PROJECTION	FINISH
1	06.096.05	96mm	118mm	29mm	Brushed Nickel
2	06.128.05	128mm	157mm	30mm	Brushed Nickel
3	06.096.06	96mm	118mm	29mm	Bright Chrome
4	06.128.06	128mm	157mm	30mm	Bright Chrome



	CODE	CENTRE	LGTH. X WDTH.	PROJECTION	FINISH
1	38.064.10	64mm	72 x 22mm	20mm	Brushed Nickel
2	38.128.10	128mm	136 x 22mm	20mm	Brushed Nickel
3	38.192.10	192mm	200 x 22mm	20mm	Brushed Nickel
4	38.256.10	256mm	264 x 22mm	20mm	Brushed Nickel

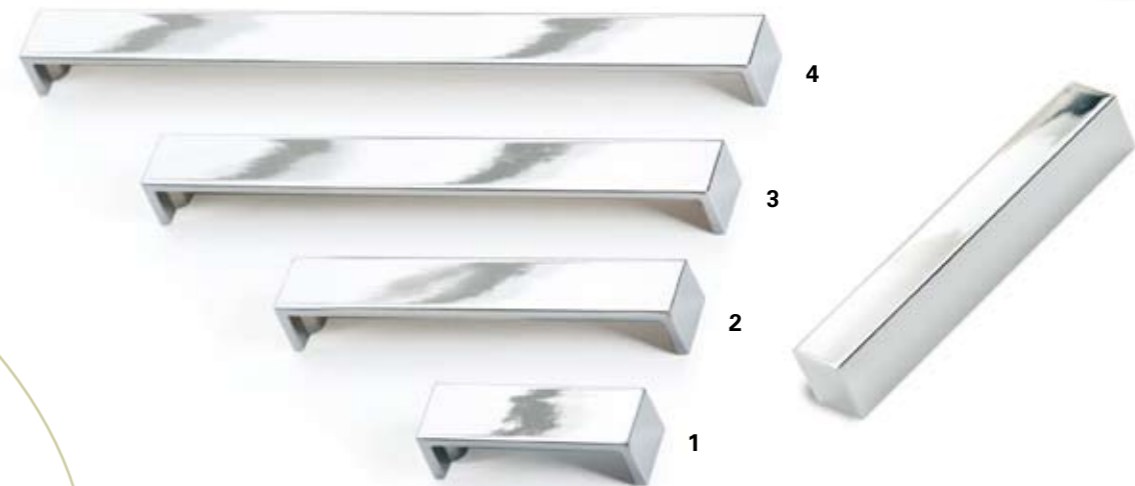

	CODE	CENTRE	LGTH. X WDTH.	PROJECTION	FINISH
1	38.064.06	64mm	72 x 22mm	20mm	Bright Chrome
2	38.128.06	128mm	136 x 22mm	20mm	Bright Chrome
3	38.192.06	192mm	200 x 22mm	20mm	Bright Chrome
4	38.256.06	256mm	264 x 22mm	20mm	Bright Chrome

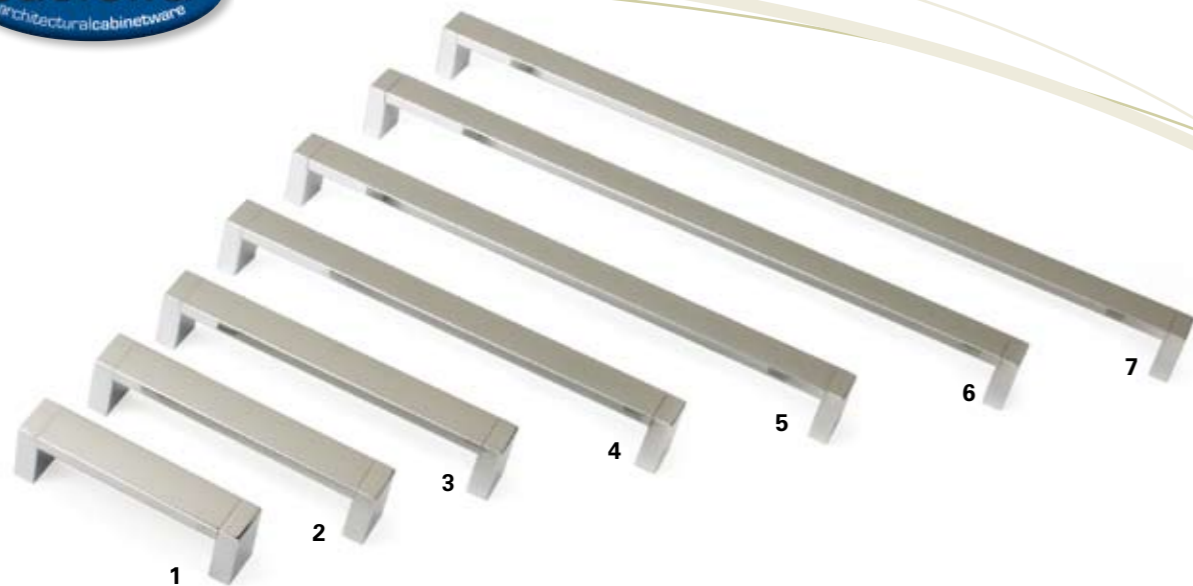

	CODE	CENTRE	LGTH. X WDTH.	PROJECTION	FINISH
1	35.096.06	96mm	107 x 22mm	30mm	Bright Chrome
2	35.128.06	128mm	139 x 22mm	30mm	Bright Chrome
3	35.160.06	160mm	171 x 22mm	30mm	Bright Chrome
4	35.224.06	224mm	235 x 22mm	30mm	Bright Chrome
5	35.288.06	288mm	299 x 22mm	30mm	Bright Chrome

	CODE	CENTRE	LGTH. X WDTH.	PROJECTION	FINISH
6	35.352.06	352mm	363 x 22mm	30mm	Bright Chrome
7	35.416.06	416mm	427 x 22mm	30mm	Bright Chrome
*	35.480.06	480mm	491 x 22mm	30mm	Bright Chrome
*	35.544.06	544mm	555 x 22mm	30mm	Bright Chrome

* Not pictured

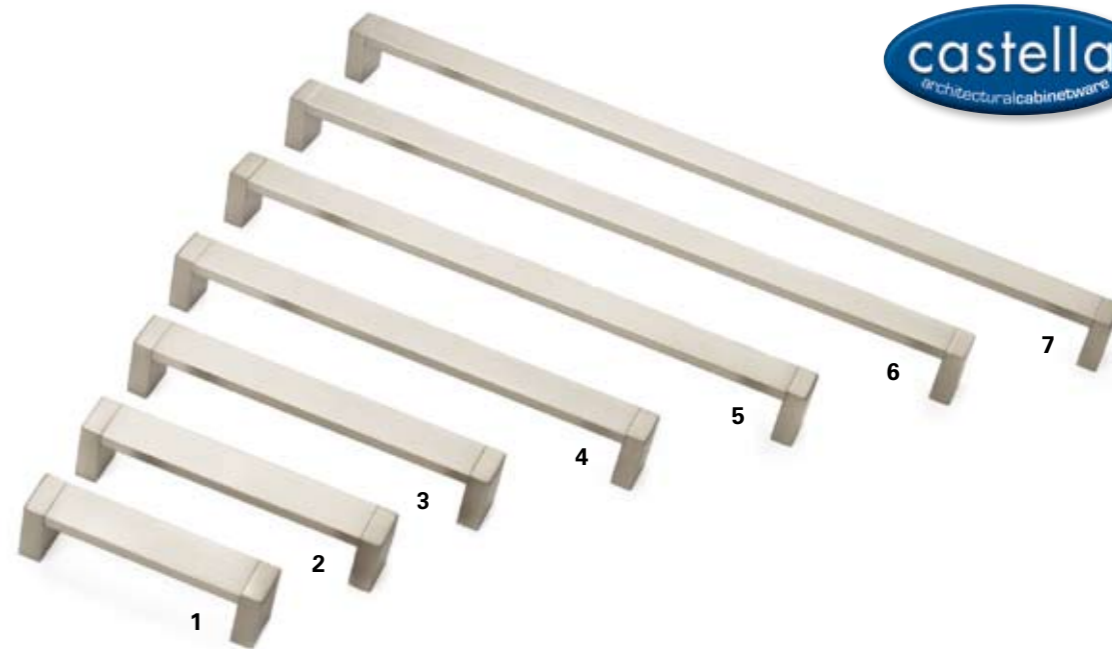

	CODE	CENTRE	LGTH. X WDTH.	PROJECTION	FINISH
1	35.096.10	96mm	107 x 22mm	30mm	Brushed Nickel
2	35.128.10	128mm	139 x 22mm	30mm	Brushed Nickel
3	35.160.10	160mm	171 x 22mm	30mm	Brushed Nickel
4	35.224.10	224mm	235 x 22mm	30mm	Brushed Nickel
5	35.288.10	288mm	299 x 22mm	30mm	Brushed Nickel

	CODE	CENTRE	LGTH. X WDTH.	PROJECTION	FINISH
6	35.352.10	352mm	363 x 22mm	30mm	Brushed Nickel
7	35.416.10	416mm	427 x 22mm	30mm	Brushed Nickel
*	35.480.10	480mm	491 x 22mm	30mm	Brushed Nickel
*	35.544.10	544mm	555 x 22mm	30mm	Brushed Nickel

* Not pictured

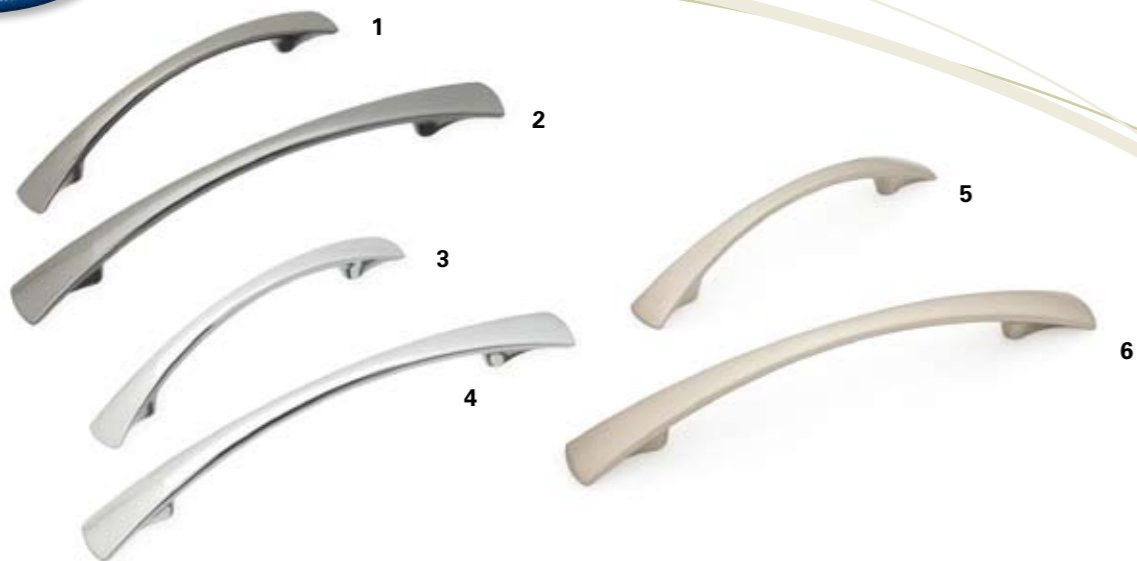

	CODE	CENTRE	LENGTH	PROJECTION	FINISH
1	30.096.09	96mm	136mm	22mm	Black Nickel
2	30.128.09	128mm	183mm	23mm	Black Nickel
3	30.096.06	96mm	136mm	22mm	Bright Chrome
4	30.128.06	128mm	183mm	23mm	Bright Chrome
5	30.096.10	96mm	136mm	22mm	Brushed Nickel
6	30.128.10	128mm	183mm	23mm	Brushed Nickel



	CODE	CENTRE	LENGTH	PROJECTION	FINISH
1	49.128.11	128mm	150mm	33mm	Aluminium
2	49.160.11	160mm	188mm	33mm	Aluminium
3	49.224.11	224mm	266mm	33mm	Aluminium
4	22.128.04	128mm	145mm	34mm	Matt Black
5	22.128.15	128mm	145mm	34mm	Satin Chrome
6	22.128.06	128mm	145mm	34mm	Bright Chrome

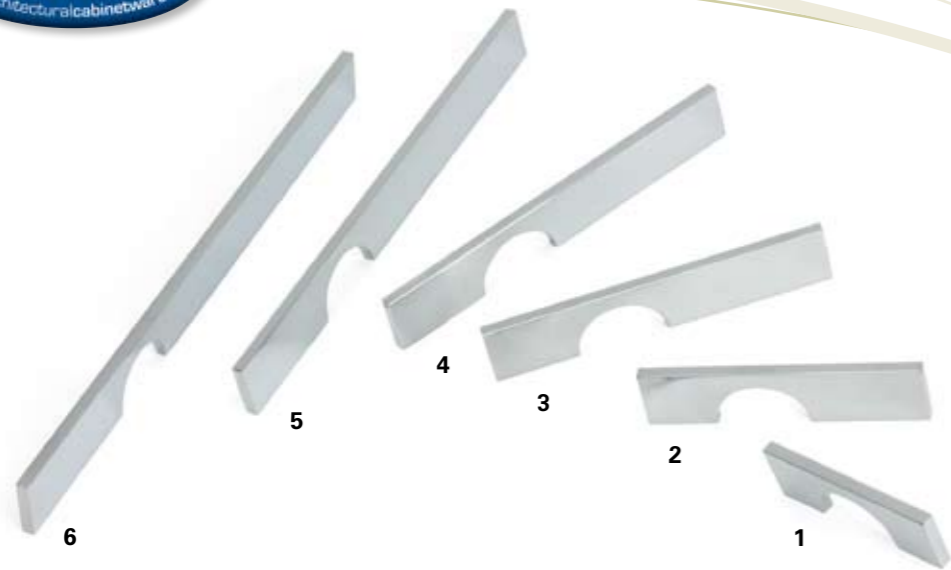

	CODE	CENTRE	LENGTH	A	B	PROJECTION	FINISH
1	65.064.06	64mm	88mm	23mm	23mm	28mm	Bright Chrome
2	65.096.06	96mm	120mm	29mm	50mm	28mm	Bright Chrome
3	65.128.06	128mm	152mm	38mm	73mm	28mm	Bright Chrome
4	65.160.06	160mm	184mm	46mm	98mm	28mm	Bright Chrome
5	65.224.06	224mm	248mm	61mm	146mm	28mm	Bright Chrome
6	65.288.06	288mm	312mm	77mm	194mm	28mm	Bright Chrome

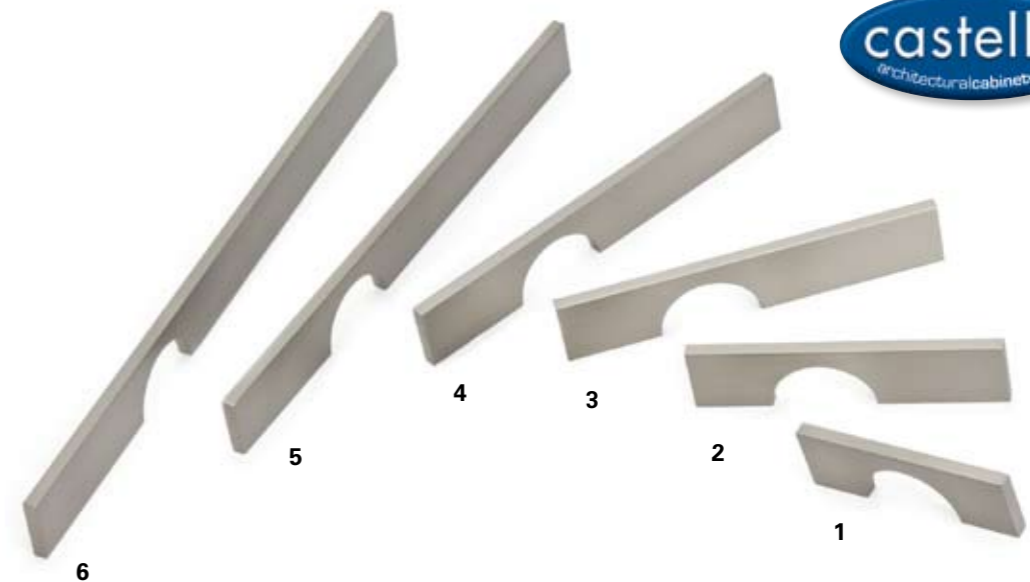

	CODE	CENTRE	LENGTH	A	B	PROJECTION	FINISH
1	65.064.10	64mm	88mm	23mm	23mm	28mm	Brushed Nickel
2	65.096.10	96mm	120mm	29mm	50mm	28mm	Brushed Nickel
3	65.128.10	128mm	152mm	38mm	73mm	28mm	Brushed Nickel
4	65.160.10	160mm	184mm	46mm	98mm	28mm	Brushed Nickel
5	65.224.10	224mm	248mm	61mm	146mm	28mm	Brushed Nickel
6	65.288.10	288mm	312mm	77mm	194mm	28mm	Brushed Nickel



french provincial

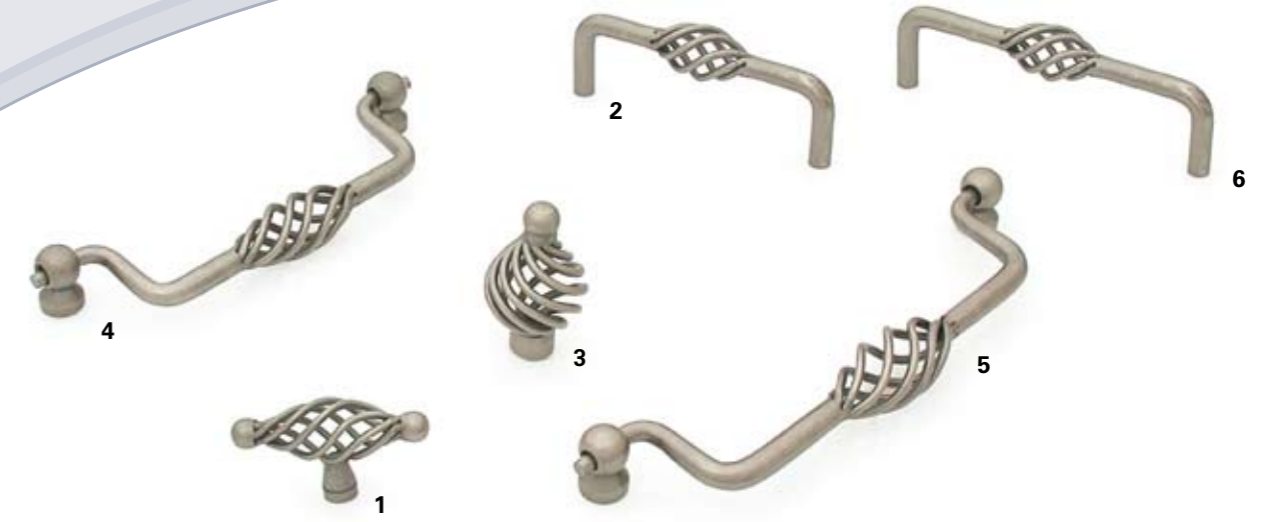

	CODE	CENTRE	LENGTH	PROJECTION	FINISH
1	58.070.14		70mm	26mm	Pewter
2	28.096.14	96mm	104mm	40mm	Pewter
3	57.034.14		34mm	53mm	Pewter
4	27.128.14	128mm	150mm	23mm	Pewter
5	27.160.14	160mm	185mm	23mm	Pewter
6	28.160.14	160mm	168mm	40mm	Pewter

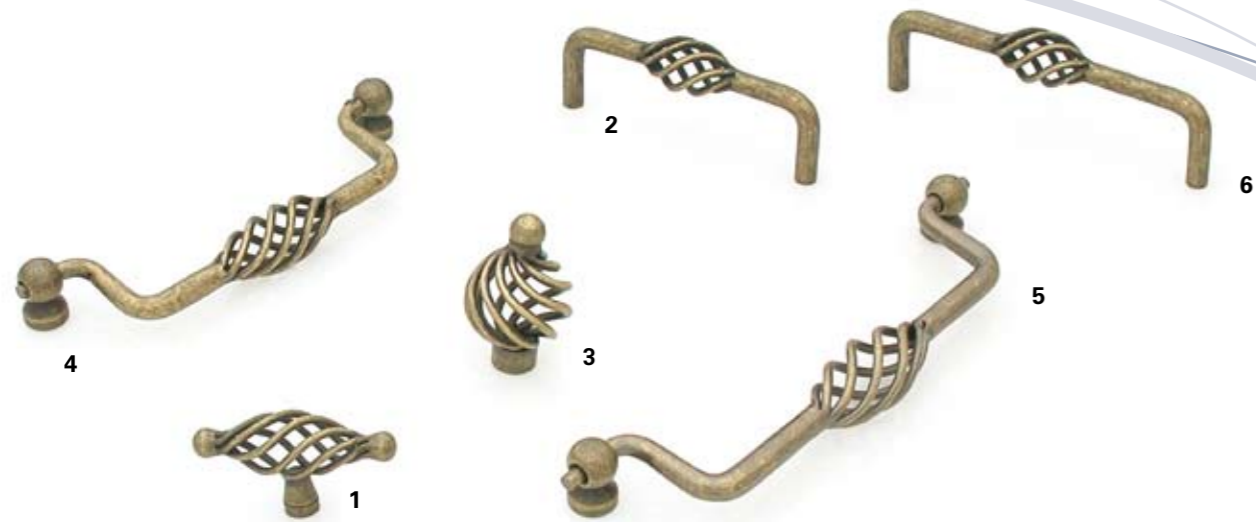

	CODE	CENTRE	LENGTH	PROJECTION	FINISH
1	58.070.03		70mm	26mm	Antique Brass
2	28.096.03	96mm	104mm	40mm	Antique Brass
3	57.034.03		34mm	53mm	Antique Brass
4	27.128.03	128mm	160mm	23mm	Antique Brass
5	27.160.03	160mm	185mm	23mm	Antique Brass
6	28.160.03	160mm	168mm	40mm	Antique Brass



	CODE	CENTRE	LENGTH	PROJECTION	FINISH
1	29.057.03		57mm	33mm	Antique Brass
2	29.160.03	160mm	180mm	25mm	Antique Brass
3	58.070.04		70mm	26mm	Matt Black
4	28.096.04	96mm	104mm	40mm	Matt Black
5	57.034.04		34mm	53mm	Matt Black
6	27.128.04	128mm	150mm	23mm	Matt Black
7	27.160.04	160mm	185mm	23mm	Matt Black
8	28.160.04	160mm	168mm	40mm	Matt Black



metropolitan

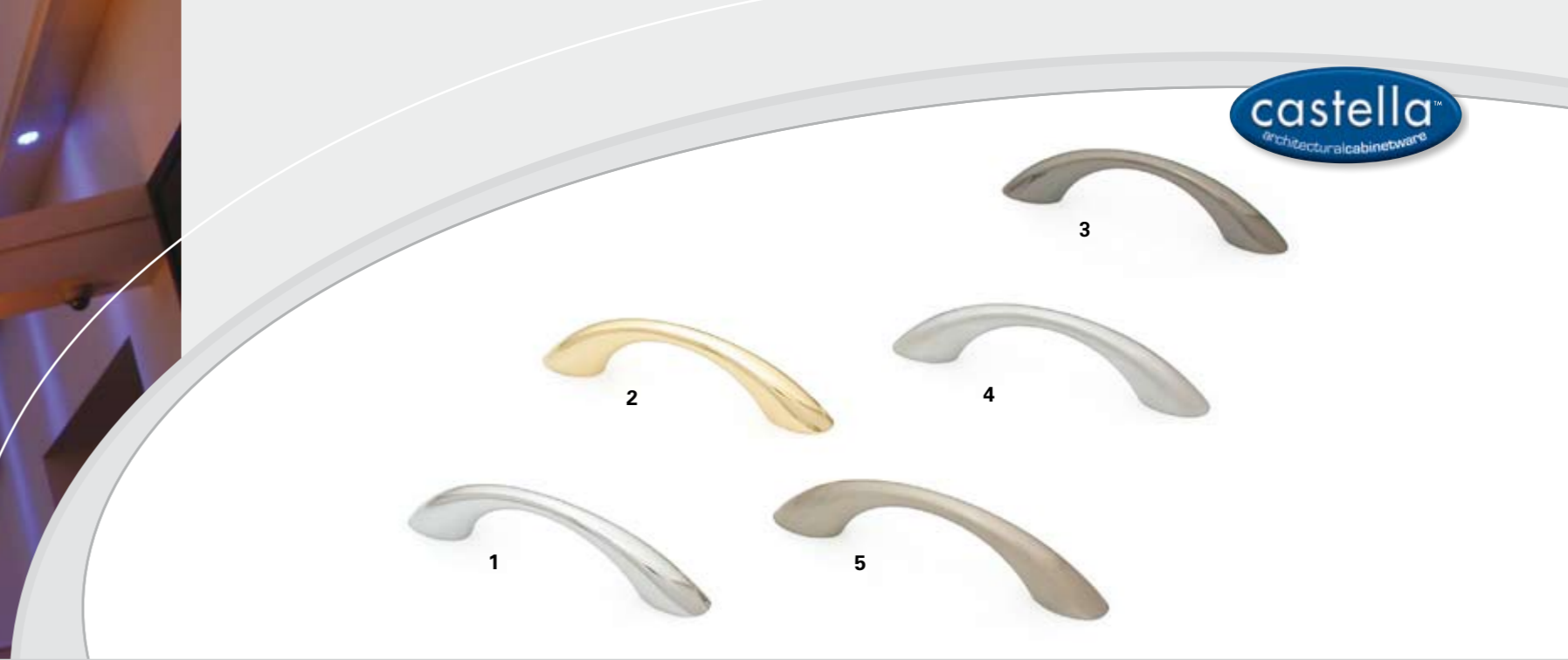

	CODE	CENTRE	LENGTH	PROJECTION	FINISH
1	01.064.06	64mm	94mm	22mm	Bright Chrome
2	01.064.08	64mm	94mm	22mm	Polished Brass
3	01.064.09	64mm	94mm	22mm	Black Nickel
4	01.064.15	64mm	94mm	22mm	Satin Chrome
5	01.064.05	64mm	94mm	22mm	Brushed Nickel



	CODE	CENTRE	LENGTH	PROJECTION	FINISH
1	01.096.06	96mm	115mm	26mm	Bright Chrome
2	01.096.08	96mm	115mm	26mm	Polished Brass
3	01.096.09	96mm	115mm	26mm	Black Nickel
4	01.096.15	96mm	115mm	26mm	Satin Chrome
5	01.096.05	96mm	115mm	26mm	Brushed Nickel



	CODE	CENTRE	LENGTH	PROJECTION	FINISH
1	01.128.06	128mm	164mm	27mm	Bright Chrome
2	01.128.08	128mm	164mm	27mm	Polished Brass
3	01.128.09	128mm	164mm	27mm	Black Nickel
4	01.128.15	128mm	164mm	27mm	Satin Chrome
5	01.128.05	128mm	164mm	27mm	Brushed Nickel

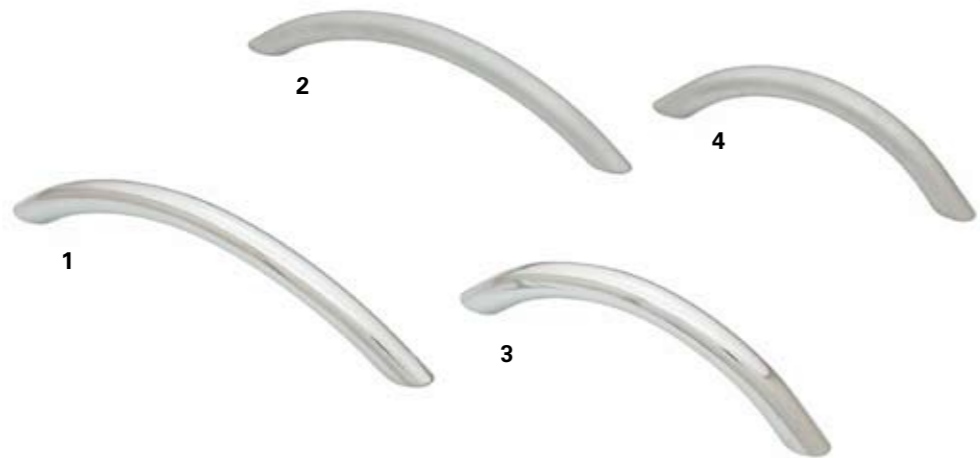

	CODE	CENTRE	LENGTH	PROJECTION	FINISH
1	04.128.06	128mm	153mm	30mm	Bright Chrome
2	04.128.15	128mm	153mm	30mm	Satin Chrome
3	04.096.06	96mm	115mm	30mm	Bright Chrome
4	04.096.15	96mm	115mm	30mm	Satin Chrome

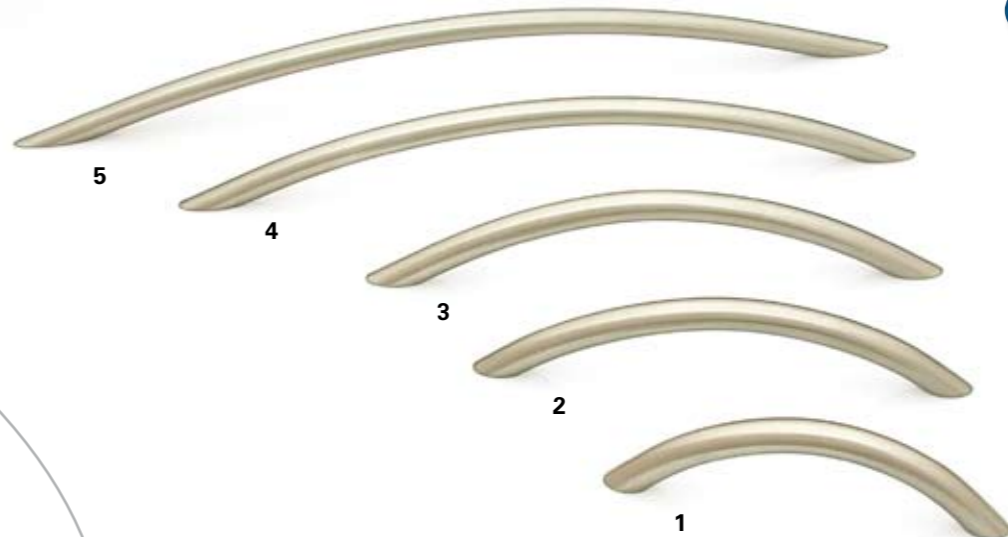

	CODE	CENTRE	LENGTH	PROJECTION	FINISH
1	04.096.05	96mm	115mm	30mm	Brushed Nickel
2	04.128.05	128mm	153mm	30mm	Brushed Nickel
3	04.160.05	160mm	190mm	32mm	Brushed Nickel
4	04.224.05	224mm	264mm	32mm	Brushed Nickel
5	04.288.05	288mm	342mm	32mm	Brushed Nickel

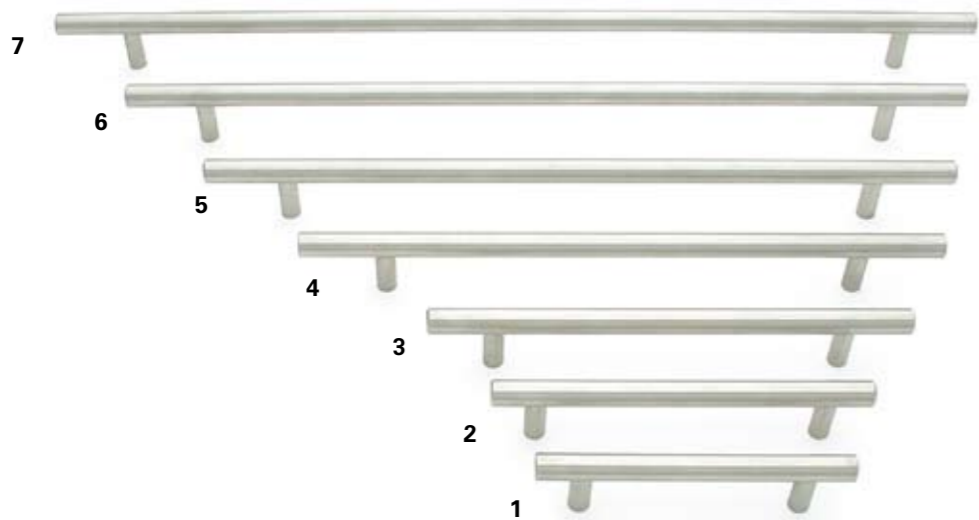

	CODE	CENTRE	LGTH. X DIAM.	PROJECTION
*	05.040.07	'T' Handle	40 x 12mm	34mm
1	05.096.07	96mm	136 x 12mm	34mm
2	05.128.07	128mm	168 x 12mm	34mm
3	05.160.07	160mm	220 x 12mm	34mm
4	05.224.07	224mm	304 x 12mm	34mm
5	05.288.07	288mm	368 x 12mm	34mm
6	05.352.07	352mm	432 x 12mm	34mm

	CODE	CENTRE	LGTH. X DIAM.	PROJECTION
7	05.416.07	416mm	496 x 12mm	34mm
*	05.480.07	480mm	560 x 12mm	34mm
*	05.544.07	544mm	624 x 12mm	34mm
*	05.608.07	608mm	688 x 12mm	34mm
*	05.704.07	704mm	784 x 12mm	34mm
*	05.800.07	800mm	880 x 12mm	34mm
*	05.896.07	896mm	976 x 12mm	34mm

	CODE	CENTRE	LGTH. X DIAM.	PROJECTION	FINISH
8	05.1120.07	1120mm	1200 x 12mm	34mm	Satin Stainless Steel
9	05.1410.07	1410mm	1490 x 12mm	34mm	Satin Stainless Steel
10	05.1920.07	1920mm	2000 x 12mm	34mm	Satin Stainless Steel

NB: Sizes from 05.544.07 and above are manufactured from hollow stainless steel tube.

Satin stainless steel. 10mm diameter post. *Not pictured



	CODE	DIAMETER	PROJECTION	FINISH		CODE	DIAMETER	PROJECTION	FINISH
1	50.030.14	30mm	31mm	Pewter	5	50.030.03	30mm	31mm	Antique Brass
2	50.030.09	30mm	31mm	Black Nickel	6	50.030.06	30mm	31mm	Bright Chrome
3	50.030.01	30mm	31mm	Antique Black	7	81.037.20	37mm	28mm	White Porcelain/ Brass Backplate
4	50.030.05	30mm	31mm	Brushed Nickel	8	80.033.20	33mm	25mm	White Porcelain

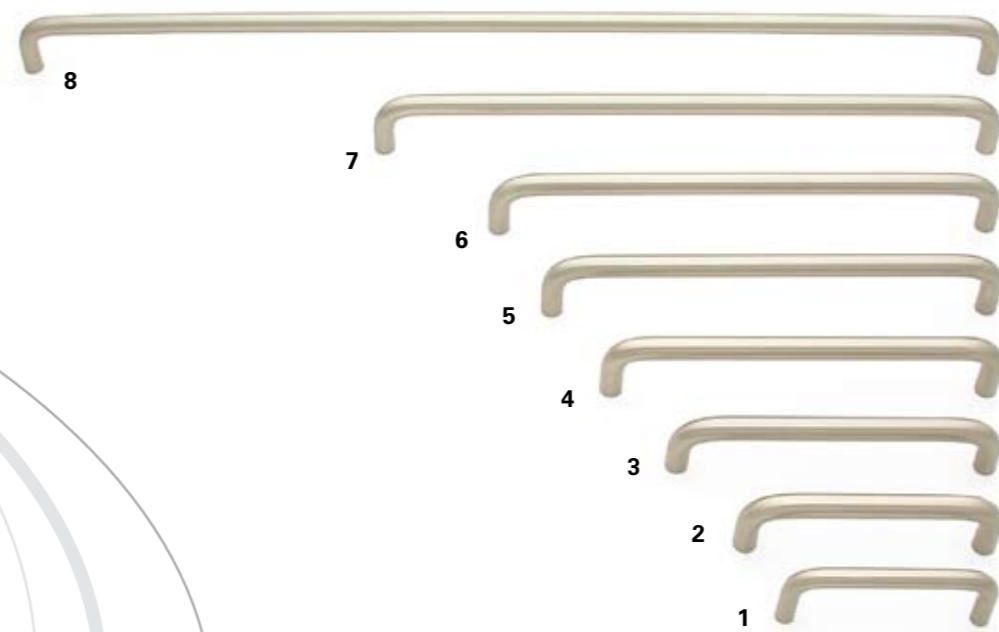

	CODE	CENTRE	LGTH X DIAM.	PROJECTION		CODE	CENTRE	LGTH. X DIAM.	PROJECTION
1	07.076.05	76mm	84 x 8mm	31mm	5	07.192.05	192mm	202 x 10mm	31mm
2	07.096.05	96mm	106 x 10mm	31mm	6	07.224.05	224mm	234 x 10mm	31mm
3	07.128.05	128mm	138 x 10mm	31mm	7	07.288.05	288mm	298 x 10mm	31mm
4	07.160.05	160mm	170 x 10mm	31mm	8	07.480.05	480mm	490 x 10mm	31mm

All Brushed Nickel Finish



	CODE	DIAMETER	PROJECTION	FINISH
1	51.038.08	38mm	35mm	Polished Brass
2	51.032.08	32mm	32mm	Polished Brass
3	52.030.08	30mm	23mm	Polished Brass
4	52.035.08	35mm	27mm	Polished Brass
5	60.030.08	30mm	23mm	Polished Brass

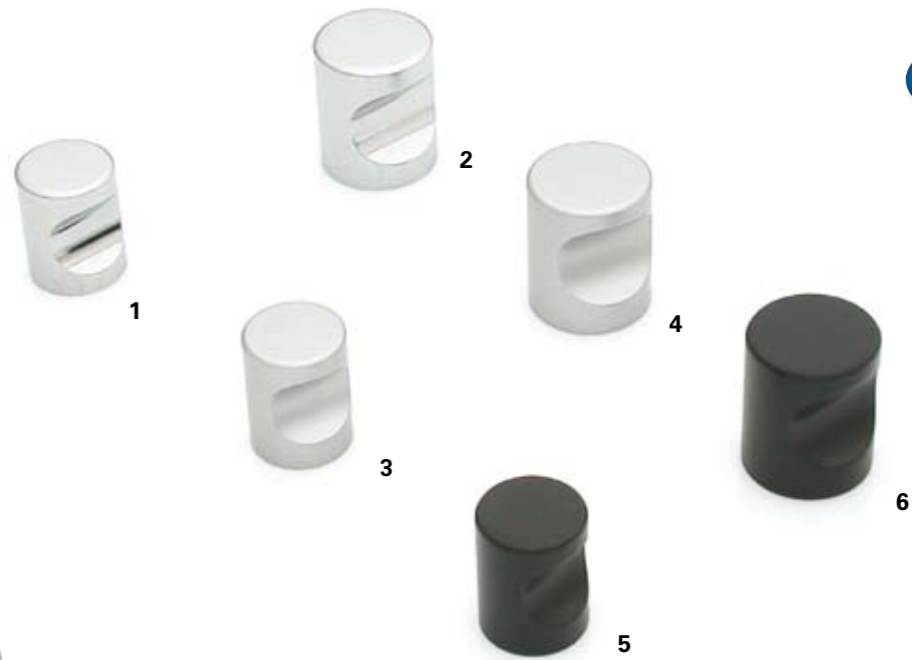

	CODE	DIAMETER	PROJECTION	FINISH
1	70.020.06	20mm	25mm	Bright Chrome
2	70.025.06	25mm	30mm	Bright Chrome
3	70.020.11	20mm	25mm	Aluminium
4	70.025.11	25mm	30mm	Aluminium
5	70.020.04	20mm	25mm	Matt Black
6	70.025.04	25mm	30mm	Matt Black



retro

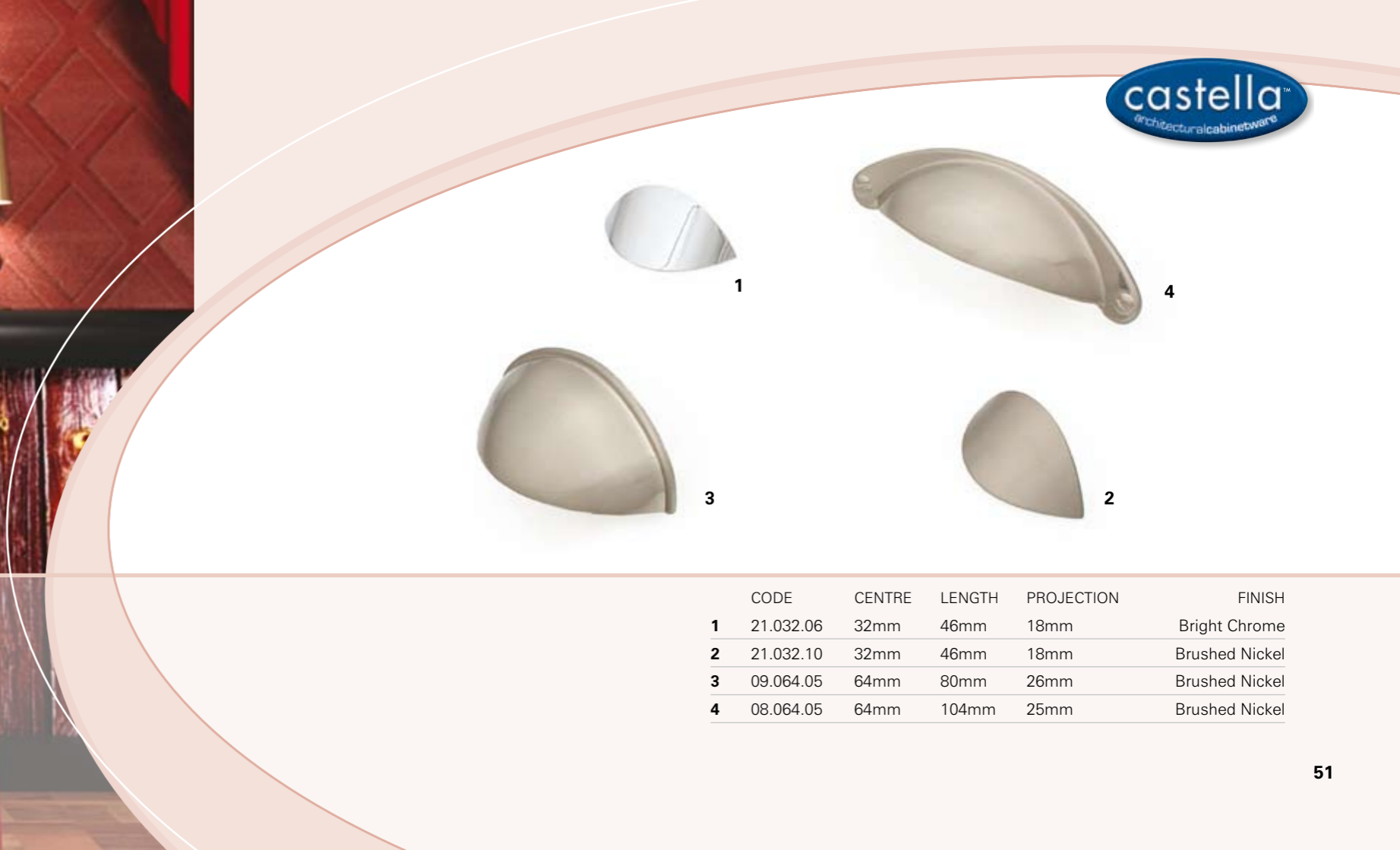

	CODE	CENTRE	LENGTH	PROJECTION	FINISH
1	21.032.06	32mm	46mm	18mm	Bright Chrome
2	21.032.10	32mm	46mm	18mm	Brushed Nickel
3	09.064.05	64mm	80mm	26mm	Brushed Nickel
4	08.064.05	64mm	104mm	25mm	Brushed Nickel



1



2



3



4

	CODE	LGTH. X DIAM.	PROJECTION	FINISH
1	16.035.10	35 x 8mm	20mm	Brushed Nickel
2	16.035.06	35 x 8mm	20mm	Bright Chrome
3	15.035.10	35 x 8mm	18mm	Brushed Nickel
4	15.035.06	35 x 8mm	18mm	Bright Chrome



1



2



3



4



5



6

	CODE	CENTRE	LGTH. X DIAM.	PROJECTION	FINISH
1	18.024.06		24mm	23mm	Bright Chrome
2	18.024.10		24mm	23mm	Brushed Nickel
3	17.035.06		35 x 14mm	17mm	Bright Chrome
4	17.035.10		35 x 14mm	17mm	Brushed Nickel
5	19.032.06	32mm	40mm	23mm	Bright Chrome
6	19.032.10	32mm	40mm	23mm	Brushed Nickel



	CODE	CENTRE	LENGTH	PROJECTION	FINISH
1	53.032.10	32mm		27mm	Brushed Nickel
2	39.128.10	128mm	143mm	31mm	Brushed Nickel
3	39.192.10	192mm	207mm	31mm	Brushed Nickel



	CODE	CENTRE	LENGTH	PROJECTION	FINISH
1	53.032.06	32mm		27mm	Bright Chrome
2	39.128.06	128mm	143mm	31mm	Bright Chrome
3	39.192.06	192mm	207mm	31mm	Bright Chrome



	CODE	CENTRE	DIAMETER	PROJECTION	FINISH
1	61.032.10		32mm	35mm	Brushed Nickel
2	59.025.10		25mm	25mm	Brushed Nickel
3	54.042.10	16mm	42 x 19mm	20mm	Brushed Nickel
4	54.042.06	16mm	42 x 19mm	20mm	Bright Chrome



veneto collection



	CODE	CENTRE	LGTH. X DIAM.	PROJECTION	FINISH
1	88.064.03	64mm	100 x 32mm	23mm	Antique Brass
2	88.032.03	32mm	73 x 30mm	23mm	Antique Brass
3	88.064.14	64mm	100 x 32mm	23mm	Pewter
4	88.032.14	32mm	73 x 30mm	23mm	Pewter



	CODE	CENTRE	LENGTH	PROJECTION	FINISH
1	89.096.14	96mm	138mm	25mm	Pewter
2	89.070.14		70mm	23mm	Pewter
3	89.064.14	64mm	96mm	24mm	Pewter



	CODE	CENTRE	LENGTH	PROJECTION	FINISH
1	89.096.03	96mm	138mm	25mm	Antique Brass
2	89.070.03		70mm	23mm	Antique Brass
3	89.064.03	64mm	96mm	24mm	Antique Brass



	CODE	CENTRE	LGTH. X HGHT.	PROJECTION	FINISH
1	85.128.14	128mm	165mm	28mm	Pewter
2	85.064.14	64mm	99 x 35mm	23mm	Pewter
3	85.050.14		50 x 20mm	23mm	Pewter
4	85.038.14		38 x 40mm	23mm	Pewter
5	85.085.14		85 x 80mm	37mm	Pewter

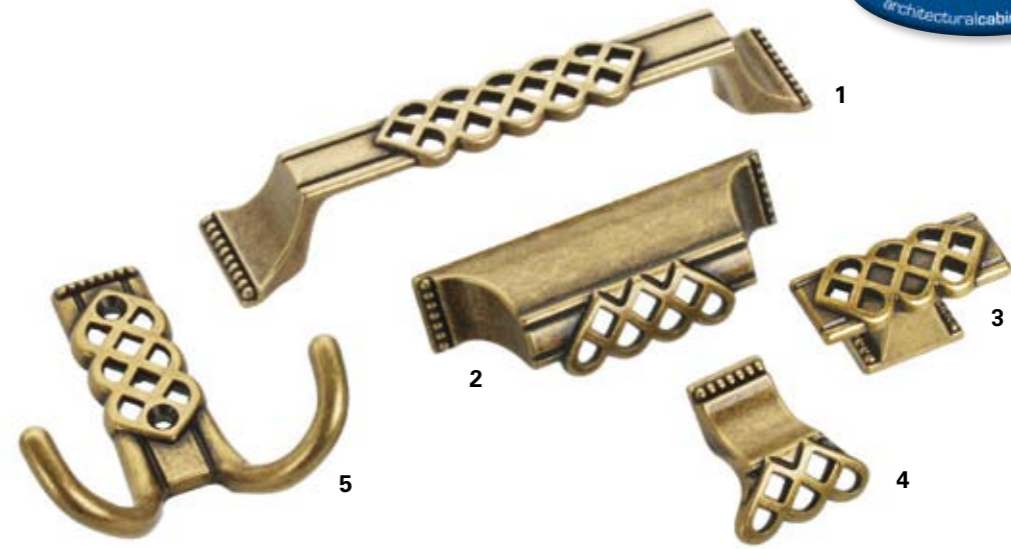

	CODE	CENTRE	LGTH. X HGHT.	PROJECTION	FINISH
1	85.128.03	128mm	165mm	28mm	Antique Brass
2	85.064.03	64mm	99 x 35mm	23mm	Antique Brass
3	85.050.03		50 x 20mm	23mm	Antique Brass
4	85.038.03		38 x 40mm	23mm	Antique Brass
5	85.085.03		85 x 80mm	37mm	Antique Brass



	CODE	CENTRE	LENGTH	PROJECTION	FINISH
1	87.096.21	96mm	110mm	41mm	White Porcelain/Antique Brass
2	87.030.21		30mm	30mm	White Porcelain/Antique Brass

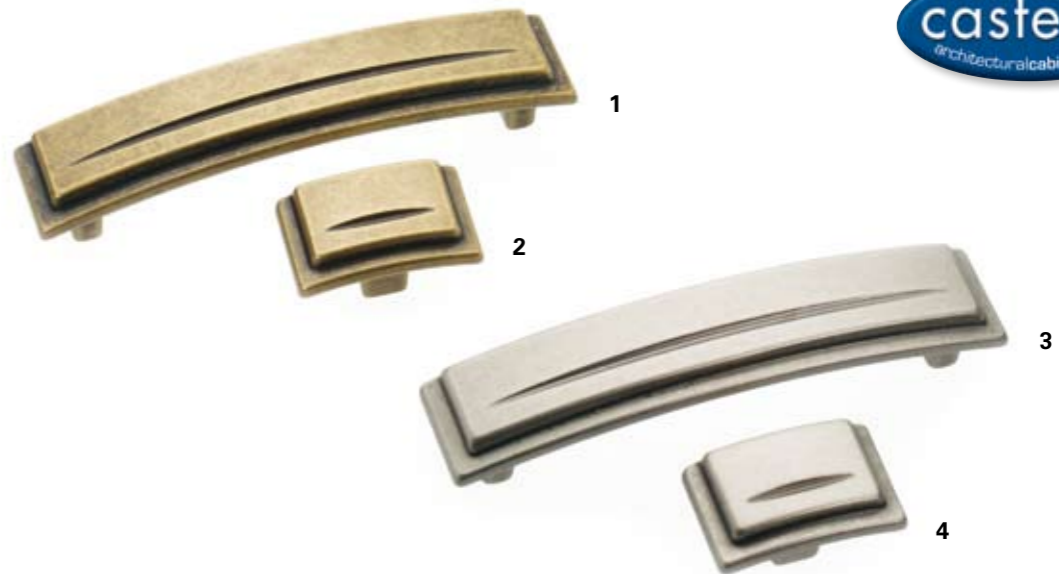

	CODE	CENTRE	LENGTH	PROJECTION	FINISH
1	86.096.03	96mm	116mm	24mm	Antique Brass
2	86.038.03		38 x 24mm	23mm	Antique Brass
3	86.096.14	96mm	116mm	24mm	Pewter
4	86.038.14		38 x 24mm	23mm	Pewter

PRODUCT INDEX

CODE	PAGE NO.														
01.064.06	39	04.160.05	43	07.128.05	47	15.035.10	52	24.896.07	18	30.096.10	30	35.352.10	29	41.160.11	12
01.064.08	39	04.224.05	43	07.160.05	47	15.035.06	52	25.128.07	9	30.128.10	30	35.416.10	29	41.128.11	12
01.064.09	39	04.288.05	43	07.192.05	47	16.035.10	52	25.160.07	9	32.096.10	11	35.480.10	29	41.096.11	12
01.064.15	39	05.1120.07	45	07.224.05	47	16.035.06	52	25.224.07	9	32.128.10	11	35.544.10	29	41.064.11	12
01.064.05	39	05.1410.07	45	07.288.05	47	17.035.10	53	25.288.07	9	32.160.10	11	36.128.10	10	42.128.11	14
01.096.06	40	05.1920.07	45	07.480.05	47	17.035.06	53	25.352.07	9	32.224.10	11	36.160.10	10	42.096.11	14
01.096.08	40	05.040.07	44	08.064.03	3	18.024.10	53	25.416.07	9	32.288.10	11	36.224.10	10	43.160.11	15
01.096.09	40	05.096.07	44	08.064.01	3	18.024.06	53	25.544.07	9	33.128.10	17	36.288.10	10	43.128.11	15
01.096.15	40	05.128.07	44	08.064.14	3	19.032.10	53	27.128.04	37	33.160.10	17	36.352.10	10	43.096.11	15
01.096.05	40	05.160.07	44	08.064.05	51	19.032.06	53	27.160.04	37	33.224.10	17	36.416.10	10	43.064.11	15
01.128.06	41	05.224.07	44	09.064.05	51	21.032.06	51	27.128.03	36	33.288.10	17	38.064.10	26	44.160.10	20
01.128.08	41	05.288.07	44	10.076.03	4	21.032.10	51	27.160.03	36	34.160.10	14	38.128.10	26	44.048.10	20
01.128.09	41	05.352.07	44	10.076.01	4	22.128.06	31	27.128.14	35	35.096.06	28	38.192.10	26	48.128.07	19
01.128.15	41	05.416.07	44	10.076.14	4	22.128.15	31	27.160.14	35	35.128.06	28	38.256.10	26	48.160.07	19
01.128.05	41	05.480.07	44	11.128.10	7	22.128.04	31	28.096.04	37	35.160.06	28	38.064.06	27	48.192.07	19
02.096.09	23	05.544.07	44	11.096.10	7	24.096.07	18	28.096.03	36	35.224.06	28	38.128.06	27	48.288.07	19
02.096.15	23	05.608.07	44	11.128.06	7	24.128.07	18	28.096.14	35	35.288.06	28	38.192.06	27	48.320.07	19
02.096.06	23	05.704.07	44	11.096.06	7	24.160.07	18	28.160.04	37	35.352.06	28	38.256.06	27	48.384.07	19
03.128.15	23	05.800.07	44	12.096.06	24	24.224.07	18	28.160.03	36	35.416.06	28	39.128.10	54	48.480.07	19
03.128.04	23	05.896.07	44	12.128.06	24	24.288.07	18	28.160.14	35	35.480.06	28	39.192.10	54	48.640.07	19
04.128.06	42	06.096.05	25	12.096.10	24	24.352.07	18	29.057.03	37	35.544.06	28	39.128.06	55	48.788.07	19
04.128.15	42	06.128.05	25	12.128.10	24	24.416.07	18	29.160.03	37	35.096.10	29	39.192.06	55	49.128.11	31
04.096.06	42	06.096.06	25	13.160.10	8	24.480.07	18	30.096.09	30	35.128.10	29	40.160.11	13	49.160.11	31
04.096.15	42	06.128.06	25	13.128.10	8	24.544.07	18	30.128.09	30	35.160.10	29	40.128.11	13	49.224.11	31
04.096.05	43	07.076.05	47	14.096.06	8	24.608.07	18	30.096.06	30	35.224.10	29	40.096.11	13	50.030.14	46
04.128.05	43	07.096.05	47	14.096.10	8	24.704.07	18	30.128.06	30	35.288.10	29	40.064.11	13	50.030.09	46

50.030.01	46	61.032.10	56	81.037.20	46	89.070.14	60
50.030.05	46	65.064.06	32	83.035.16	5	89.064.14	60
50.030.03	46	65.096.06	32	83.035.17	5	89.096.03	61
50.030.06	46	65.128.06	32	84.070.16	5	89.070.03	61
51.038.08	48	65.160.06	32	84.070.17	5	89.064.03	61
51.032.08	48	65.224.06	32	85.128.14	62		
52.030.08	48	65.288.06	32	85.064.14	62		
52.035.08	48	65.064.10	33	85.050.14	62		
53.032.10	54	65.096.10	33	85.038.14	62		
53.032.06	55	65.128.10	33	85.085.14	62		
54.042.10	56	65.160.10	33	85.128.03	63		
54.042.06	56	65.224.10	33	85.064.03	63		
55.128.10	14	65.288.10	33	85.050.03	63		
55.096.10	14	66.352.10	17	85.038.03	63		
55.025.10	14	66.096.14	16	85.085.03	63		
56.034.03	5	66.128.14	16	86.096.14	65		
56.034.01	5	66.160.14	16	86.038.14	65		
56.034.14	5	66.224.14	16	86.096.03	65		
57.034.04	37	66.288.14	16	86.038.03	65		
57.034.03	36	70.025.06	49	87.096.21	64		
57.034.14	35	70.020.06	49	87.030.21	64		
58.070.04	37	70.025.11	49	88.064.03	59		
58.070.03	36	70.020.11	49	88.032.03	59		
58.070.14	35	70.025.04	49	88.064.14	59		
59.025.10	56	70.020.04	49	88.032.14	59		
60.030.08	48	80.033.20	46	89.096.14	60		

NOTES

Due to limitations in the printing process, the colours and finishes in this catalogue are a guide only.

The manufacturer/distributor reserves the right to vary specifications or delete models from their range without prior notification.

All measurements are in millimetres unless stated otherwise.

Printed December 2010.



DISTRIBUTED BY

