



HOME ELEVATOR FOR MODERN FAMILY

Creating a bespoke lift design to suit your individual needs is now possible. You can have both beauty, comfort & value in a straightforward installation!

250-500 KG
rated load

12 meters
travel height

5-6 persons
capacity

6 Stops
landings

TOP 4 REASONS WHY CLIENTS CHOOSE LINEA

1

Wide range of cabin finishes & colours

The Linea home lift range offers a clean and modern selection of various finishes, cabin options, materials, accessories to give your home an unmissable touch.

Each lift is designed to reflect your preferences, with most elements being able to adjusted to suit your decor or environment.

2

Made-to-measure projects

A versatile home lift which can be adapted to every property: narrow shafts, dedicated areas indoor or outdoor. Linea Lift is a discreet solution to assist in movement around the house.

The cabin dimension vary from a minimum of **500 x 1000mm** and a **maximum of 1100 x 1400mm**. Minimum pit of 200mm which can be created but not necessary.

3

Safety and comfort

Home and commercial lift with extreme usability to improve the comfort the user experience such as smooth and silent ride, -automatic return to the floor in case of power failure, able to work with 3 different operations: **(hold-to-run, automatic operation at landings and automatic operation both in car and at landings)**, Remote control on the lift system and telephone connection inside the cabin and Proactive maintenance.

4

Energy efficiency

Linea home lift requires low energy and respects the environment, it saves money on the bill and reduces air pollution.

- **Class A" energy rating** according to the German Directive VDI 4707, for energy efficiency in the building industry
- **95% manufactured** with recyclable materials
- The Linea Lift with traction model requires only 0.75 kW, the **same as a vacuum cleaner!**
- **Eco friendly home lift:** the CO2 emissions are reduced by 70%
- The Hydraulic Drive allows for exceptional **dimensional flexibility**
- **The Gearless Drive, that does not imply the use of oil,** is managed by a Smart-Inverter
- The thermal-break doors guarantee the **thermal insulation** between the outdoor lift and the inside of the building

MAKE YOUR HOME MORE ACCESSIBLE

Home elevators are the best way to get from floor to floor in your house! They're convenient, accessible, and can be installed anywhere that meets the requirements. **Plus, when you're ready to sell your house, it'll give potential buyers one more thing on their list: [accessibility options](#) (and we all know how important this is!).**

STYLISH & ELEGANT SOLUTIONS

TAILOR-MADE LIFTS

Each Linea Lift is tailor-made to suit your specific dimensions and preferences from a wide range of finishes/features.

Simplifying Accessibility

Transform any home or commercial premises into a place that all people can easily traverse. With limited builder's works required, Linea lifts are quick and easy to install, usually within 1-2 weeks.

The Linea is an alternative to high-speed elevators, which can attract high servicing costs and upfront costs.

Lift Solutions For Every Building

Architects and industry professionals highly regarded our vertical lifts for commercial and residential applications that may provide you with the answer to your access dilemmas.

If you're looking for a bespoke solution that takes your project to new heights, look no further. Our lifts are perfect for commercial and residential usage with an extensive selection.

We have installed hundreds of lifts in different organisations such as offices, schools, childcare, retail, restaurants, churches and more building types throughout Australia.

Project in Canberra, ACT



Project in Brisbane, QLD



Project in Castle Hill, NSW

SLIDING DOOR PLAN

Automatic Operation with Sliding Doors

Cabin entrances

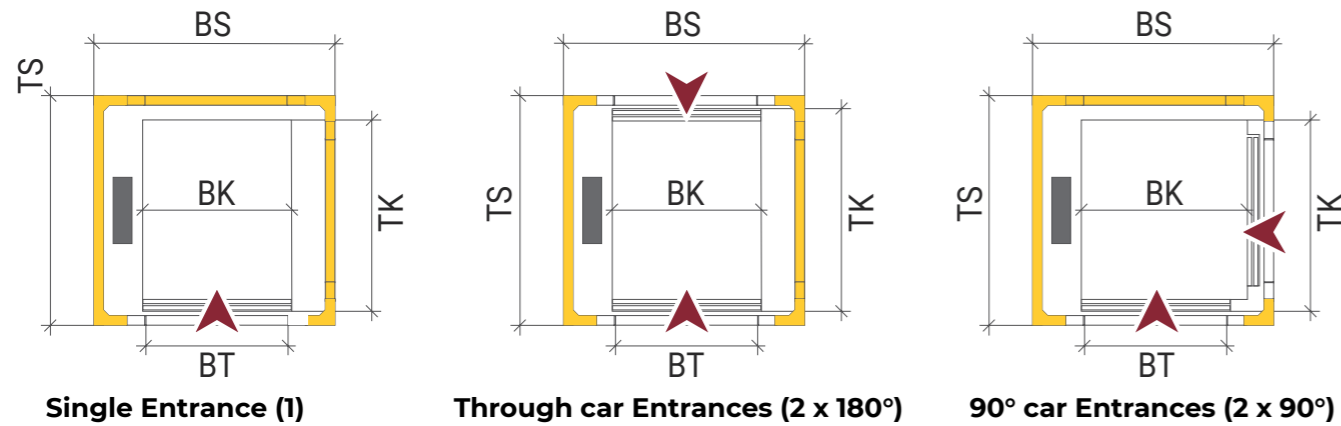

Single Entrance (1)

Through car Entrances (2 x 180°)

90° car Entrances (2 x 90°)

For special and made-to-measure projects, contact us to check the feasibility.

DUTY LOAD / CAPACITY			CABINS			
Person	Access	Duty Load	Width BK	Depth BK	Door Width BT	No. of Entrances
2	/	200kg	800	800	700	$\frac{1}{2 \times 180^\circ}$
4	♿	300kg	900	1300	800	$\frac{1}{2 \times 180^\circ}$
4	♿♿	300kg	1000	1200	800	$\frac{1}{2 \times 180^\circ}$
4	♿♿	300kg	1000	1200	800	$\frac{1}{2 \times 180^\circ}$
5	♿♿♿	400kg	1200	1200	800	2 x 90°
5	♿♿♿	400kg	1100	1400	900	$\frac{1}{\frac{2 \times 180^\circ}{2 \times 90^\circ}}$
6	♿♿♿♿	500kg	1400	1400	900	2 X 90°
6	♿♿♿♿	500kg	1000	2000	800	$\frac{1}{2 \times 180^\circ}$

SWING DOOR PLAN

Self Closing Operation w/ Swing Doors

Cabin entrances

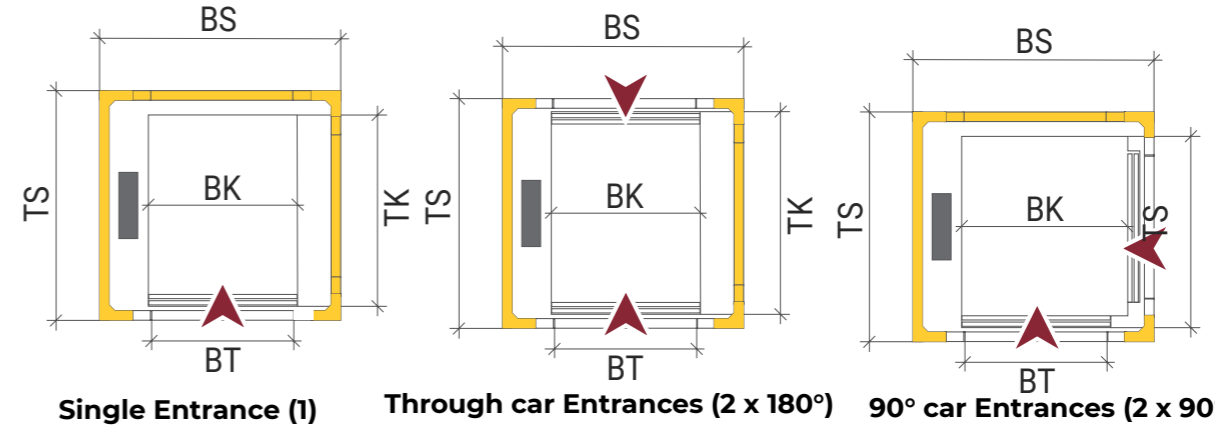

Single Entrance (1)

Through car Entrances (2 x 180°)

90° car Entrances (2 x 90°)

For special and made-to-measure projects, contact us to check the feasibility.

DUTY LOAD / CAPACITY			CABINS			
Person	Access	Duty Load	Width BK	Depth BK	Door Width BT	No. of Entrances
2	/	200kg	800	800	750	$\frac{1}{2 \times 180^\circ}$
4	♿	300kg	800	1200	800	$\frac{1}{2 \times 180^\circ}$
4	♿♿	300kg	900	1300	800	$\frac{1}{2 \times 180^\circ}$
4	♿♿	300kg	1000	1200	800	$\frac{1}{2 \times 180^\circ}$
5	♿♿♿	400kg	1200	1200	800	2 x 90°
5	♿♿♿	400kg	1100	1400	800	$\frac{1}{\frac{2 \times 180^\circ}{2 \times 90^\circ}}$
6	♿♿♿♿	500kg	1400	1400	900	2 X 90°
6	♿♿♿♿	500kg	1000	2000	900	$\frac{1}{2 \times 180^\circ}$

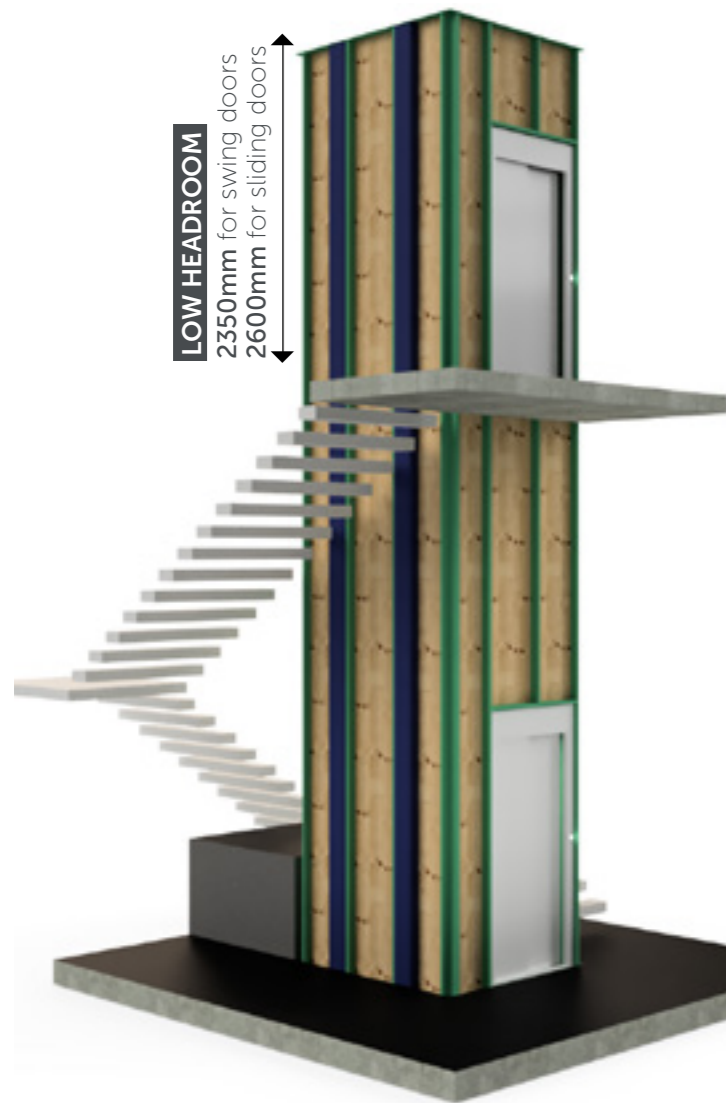

STUD FRAMED SHAFT

WITH INTERNAL LINING

- 2x Steel support by customer or builder
- Indoor or Outdoor
- Cost-Effective
- Reduced installation time
- Easily sheeted in your choice of material

They are used in residential construction as the most cost-efficient lift shaft method. Direct Lifts will supply detailed drawings with loads for the projects engineer to integrate into the buildings plans. With a commercial project, confirm fire rating/materials required with certifier/fire engineer.

Minimum Pit:

Swing Door - 100mm
Sliding Door Hydraulic - 150mm
Sliding Door Gearless - 200mm

MANSONRY SHAFT

- Provided by customer or builder
- Indoor or Outdoor
- Fire Rated
- Low Maintenance

Traditional lift shaft design is structurally robust for heavier loads and fire rated.

For more significant effect, the lift car can have glass walls in combination with murals/graphics within the shaft walls.

Minimum Pit:

Swing Door - 100mm
Sliding Door Hydraulic - 150mm
Sliding Door Gearless - 200mm



FULL GLAZED SHAFT

- Provided by Builder & Glazier
- Usually Indoor Environments
- 1x Structural Wall & Door Frames Requirements
- A Bespoke Feature To Any High-End Project

We will supply a detailed drawing and support with the integration of the lift and glazing for a successful result.

A high level of attention to detail is required.

Minimum Pit:

Swing Door - 100mm
Sliding Door Hydraulic - 150mm
Sliding Door Gearless - 200mm

METAL GLAZED SHAFT

- Provided by [Direct Lifts Australia](#)
- Indoor & Outdoor Rated
- Powdered Coated In Any RAL Colours
- Wide Range of Glass Colours

We can install a finished product with a proprietary engineered frame. A range of glazing profiles is available to suit your preference in appearance.

Glazing Profiles Available

Minimum Pit:

Swing Door - 100mm
Sliding Door Hydraulic - 150mm
Sliding Door Gearless - 200mm

GEARLESS



Saves **90% less energy** compare to other system

- Whisper-quiet operation perfect for residential and business contexts
- Best option for low to high traffic applications
- Smoother ride w/ VVVF controlled electronics
- No oil required with the Gearless Drive
- Re-leveling function to handle load changes
- The emergency automatic rescue device prevents passengers from becoming trapped inside the lift during a power failure.

DRIVE TYPE	1:1 or 2:1 (Heavy Duty) Traction with Low Friction Gearless Motor
STANDARD	NCC E3.6 "Small Sized Low Speed Automatic Lift" AS1735.11, AS1735.12, AS1735.16, AS1735.18
TRAVEL HEIGHT	Up to 12m for Commercial or Residential
LOAD	250 kg - 300 kg - 350 kg - 400 kg - 450kg
MAX STOPS	6
TRAVEL MAX	12
SPEED MAX	0.15 m/s - 0.30 m/s
MOTOR POWER	0.75 kw - 1.0kw
MINIMUM PIT	200mm
MIN HEADROOM	2400mm Swing doors & 2600 Sliding door
POWER SUPPLY	Single-Phase / 230 vac /32 A



Side view of the **Gearless** permanent magnet motor.

HYDRAULIC



Value and **robustness** via proven fluid driven technology

- Budget friendly and economical to install
- Serves low to medium buildings
- Straightforward design that's low maintenance.
- Twin valve dual speed offers smooth starting & stopping of the lift

DRIVE TYPE	Twin Speed Hydraulic with Soft Start and Stop
STANDARD	NCC E3.6 "Small Sized Low Speed Automatic Lift" AS1735.11, AS1735.12, AS1735.16, AS1735.18
TRAVEL HEIGHT	Up to 12m for Commercial or Residential
LOAD	250 kg - 300 kg - 350 kg - 400 kg - 450kg
PASSENGERS	YES
MAX NUM. STOPS	6
TRAVEL MAX.	12
SPEED MAX.	0.15 m/s - 0.3 m/s
MOTOR POWER	1.5 - 2.2 - 4.7 kW
MINIMUM PIT	150 mm.
MIN HEADROOM	2.350mm
POWER SUPPLY	230v Single Phase or Optional 400v Three Phase

Available in various configurations to suit travel up to 12m.

Hydraulic lifts are ideally suited to rural locations as they are a straight forward design.



We offer the option of a **submerged pump** which reduces sound levels remarkably vs our competitors.

OPTIONAL TRIM PACK WITH HALF MIRROR

BLUE

METALLIC (F12pps)



BLACK GLOSS

WHITE GLOSS

STANDARD CABIN RANGE

MILK A4 (MATT)

BREEZE

Our entry model lift car, adaptable to any environment. Solid car walls, made in steel and plastic coated finish in the colour of your choice. Clean lines and quality details to give it the extra touch. Trim/Skirtings pack is available as an option in Stainless range as well as mirrors and handrails.

- **Walls:** Skinplate (Easy to clean and hard wearing plastic laminate)
- **Ceiling:** 4x LED Downlights (Other types by request)
- **Floor:** Anti-slip rubber or 20mm recess for flooring by others i.e carpet tiles and timber
- **Control Panel:** Satin Stainless or Metallic F12pps (Smudge Resistant) (Other finishes by request), Handrails and Mirrors



R10 GRAPHITE



G1 CREAM



N1 GREY



GLOSS PPS11

DOOR & WALL FINISHES

RAL POWDER COATING DOOR (GLOSS)

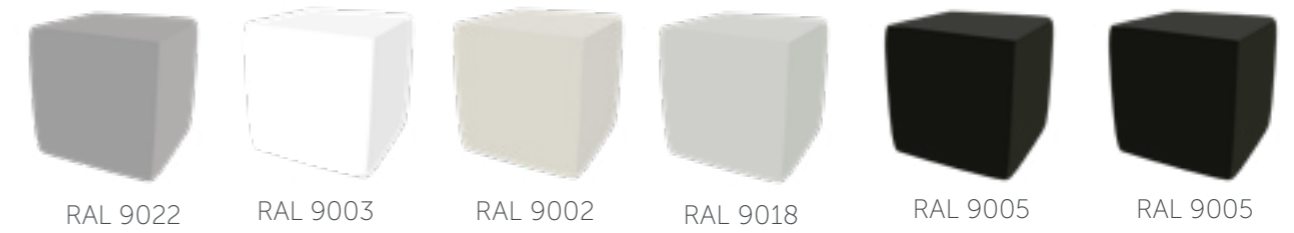

CLOSEST MATCHING SKINPLATE (GLOSS)



RAL POWDER COATING DOOR (MATT)

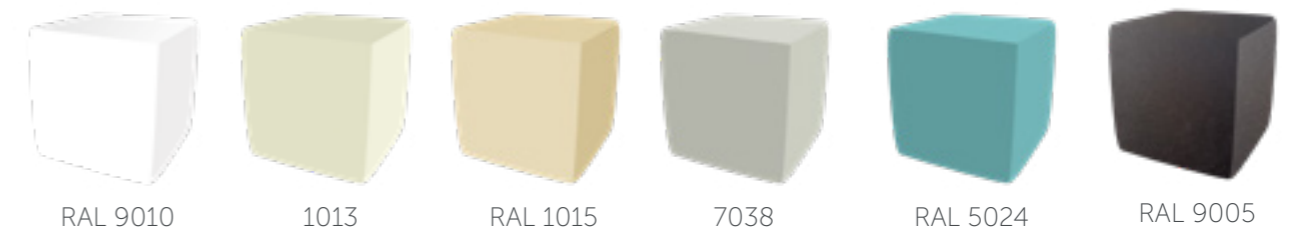

CLOSEST MATCHING SKINPLATE (MATT)

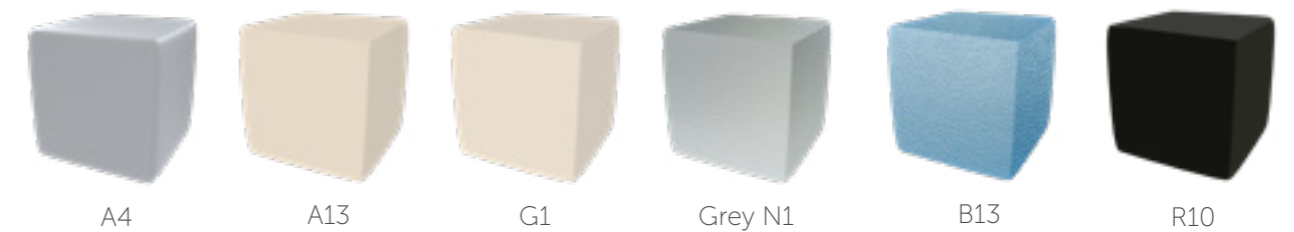



TIMBER

A warmer option with our prime lift car. Melamine walls that look great in a classic wooden finish, or extravagant with a modern design. recommended for private homes, office buildings, and apartment buildings.

- **Walls:** Melamine
- **Ceiling:** 4x LED Downlights (Other types by request)
- **Floor:** Anti-slip rubber or 20mm recess for flooring by others i.e carpet tiles and timber
- **Control Panel:** Satin Stainless or Metallic F12pps
- **Optional:** Handrails and Mirrors

WALL FINISHES

LAMINATED WALLS

S-RANGE



Maple



Cherry



Mongoy

I-RANGE



Douglas Ice
388 Microline



Acero Ottawa
385 Papier



Douglas Vanilla
381 Microline



Douglas
387 Microline



Teak Sumatra
1612 Sei-Due

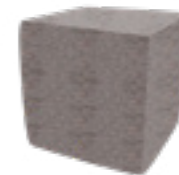

Rovere Tennessee
656 Holz



STAR

Highest quality laminate walls to match your buildings decor. Suspended ceilings available for those wanting to add the extra touch.

- **Walls:** Laminate Walls
- **Ceiling:** 4x LED Downlights (Other types by request)
- **Floor:** Anti-slip rubber or 20mm recess for flooring by others i.e carpet tiles and timber
- **Control Panel:** Satin Stainless or Metallic F12pps
- **Optional:** Handrails and Mirrors

WALL FINISHES

LAMINATE WALLS



Vogue Wood

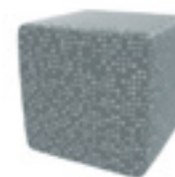

White Folkstone



Ivory Oak Cross

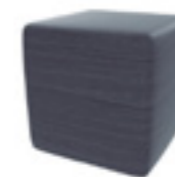

Ebony Oak Cross



Concrete Formwood



Cherry



Wavy Polished Stainless Steel



AIR

Robust Stainless Steel car walls that will remain like new throughout the years. Choose a mirrored finish for an inspiring result or a patterned finished if your lift is located in a public setting. Recommended for apartment buildings, hotels, hospitals and industrial environments.

- **Walls:** Stainless
- **Ceiling:** 4x LED Downlights (Other types by request)
- **Floor:** Anti-slip rubber or 20mm recess for flooring by others i.e carpet tiles and timber
- **Control Panel:** Satin Stainless or Metallic F12pps (Smudge Resistant) (Other finishes by request),
- **Optional:** Trim Pack (Skirtings), Handrails and Mirrors

WALL FINISHES

STAINLESS STEEL WALLS



Brushed



Mirror



Linen



Patterned



Polished
Stainless Steel



INFINITY

Your lift is not just a mode of transportation anymore, but the jewel and heart of your building with our Infinity lift cars. Walls made in coloured Stainless Steel to allow for a stylish and sophisticated interior. Recommended for private homes, hotels and high-end buildings.

- **Walls:** Coloured Stainless
- **Ceiling:** 4x LED Downlights (Other types by request)
- **Floor:** Anti-slip rubber or 20mm recess for flooring by others i.e carpet tiles and timber
- **Control Panel:** Satin Stainless or Metallic F12pps (Smudge Resistant) (Other finishes by request),
- **Optional:** Trim Pack (Skirtings), Handrails and Mirrors

WALL FINISHES

STAINLESS STEEL WALLS



Brushed Gold
Stainless Steel

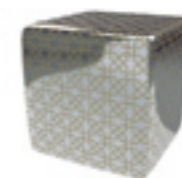

Etched Gold
Stainless Steel



Brushed Bronze



Mirror Bronze



Mirror Gold
Stainless Steel



Mirror
Stainless Steel



CRYSTAL

Contemporary finish to match the refined lines of your building. Walls in coloured back painted glass that always look fresh and lively. Recommended for private homes, hotels and high-end buildings.

- **Walls:** Coloured Glass
- **Ceiling:** 4x LED Downlights (Other types by request)
- **Floor:** Anti-slip rubber or 20mm recess for flooring by others i.e carpet tiles and timber
- **Control Panel:** Satin Stainless or Metallic F12pps (Smudge Resistant) (Other finishes by request),
- **Optional:** Trim Pack (Skirtings), Handrails and Mirrors

WALL FINISHES

GLASS PAINTED WALLS



Black



Clear Blue



White



SKY

Custom Buttons Available, Contact us for options
Transparent glass walls that will allow you to enjoy the views while traveling up. Combined with a glass structure, allowing for 360 degree views no matter where you place it in your building.

- **Walls:** Glass with Stainless, Skinplate or RAL Colours
- **Ceiling:** 4x LED Downlights (Other types by request)
- **Floor:** Anti-slip rubber or 20mm recess for flooring by others i.e carpet tiles and timber
- **Control Panel:** Satin Stainless or Metallic F12pps (Smudge Resistant) (Other finishes by request)
- **Optional:** Trim Pack (Skirtings), Handrails and Mirrors

WALL FINISHES

GLASS OR STAINLESS STEEL WALLS



Clear Glass



Frosted Glass



Bronze Glass



Brushed



Linen



Mirror

SWING DOORS



GRAPH

Painted in RAL 9010
Pure White



WOOD

Panoramic
Clear Glass or Milk Glass



SUPER PANORAMIC



PANORAMIC



KRYSTAL

Panoramic
Clear Glass or Milk Glass



ANNA

With vertical panoramic window and flush handle
painted in RAL 7035 Pebble Grey



EMMA

EI120 Fire rated
door available

ALUMINIUM SWING DOORS



LUMINA BROWN
Silver anodised door dark brown flush handle bronze glass



LUMINA BLACK
Silver anodised door black flush handle smoked grey glass



LUMINA WHITE
Silver anodised door white flush handle milk white glass



I-LUMINA
Painted in RAL in 9005 black flush handle courtesy led light smoked grey glass

GLASS COLOURS FOR SWING DOORS



PUSH BUTTONS



UPGRADED DISPLAYS



AUTOMATIC SLIDING DOOR TYPE



SOLID
RAL colours or stainless range



FRAMED GLASS
RAL colours or stainless range

PANORAMIC WINDOWS



FRAMELESS GLASS
RAL colours or stainless range



Full width, mid height window

Full width, full height window

2x Full width, full height windows

AUTOMATIC SLIDING DOORS PANEL TYPE

Framed glass for cabin and landing side or centre opening painted in RAL 7047 telegrey



3-PANEL SLIDING DOOR



2-PANEL SLIDING DOOR



Winston Hills, SYD
Automatic frameless glass door

2-FRAMELESS SILIDING DOOR (3-PANEL AVAILABLE)

FLOOR FINISHES & DISPLAYS

RUBBER FLOOR TYPES

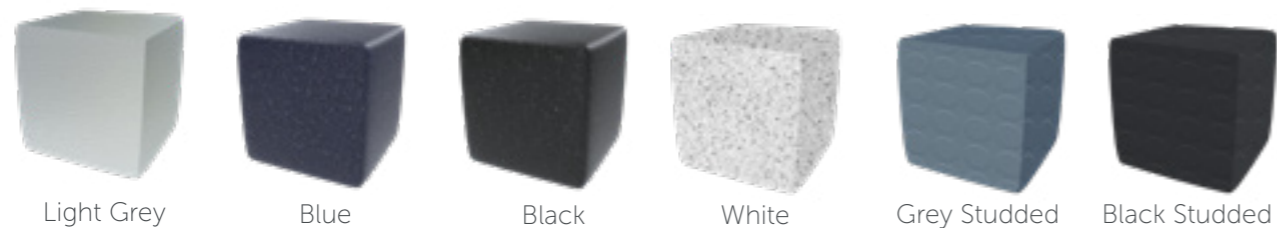

STONE FLOOR TYPES



OTHER - FLOOR TYPES



METAL - FLOOR TYPES



STANDARD DISPLAYS



COP FINISHES



Stainless full height COP

LOP DISPLAY



LIGHTS FOR CEILING



2X LED downlight flush



4X LED downlights flush

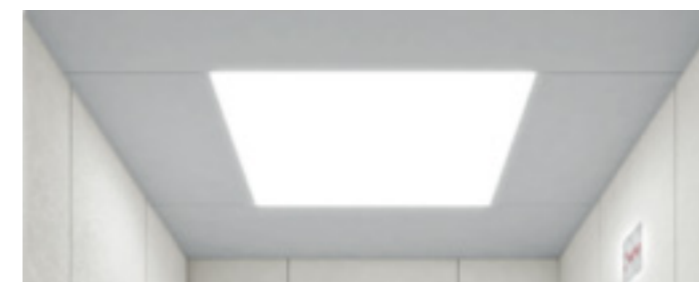

LED panel flush

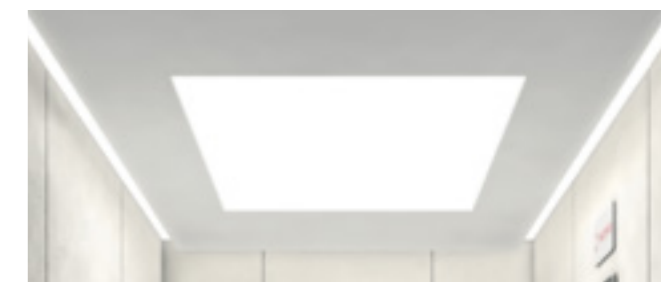

LED sunrise suspended*



LED circle suspended*

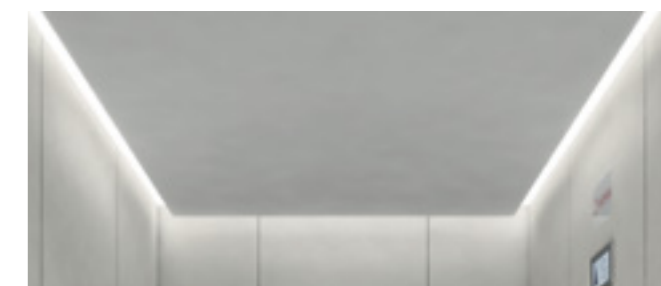

LED soft suspended*



LED zodiaco suspended*

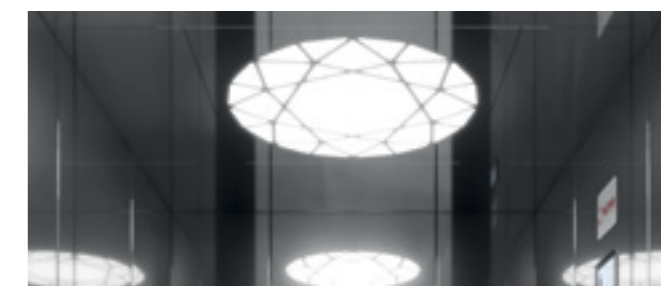

LED black diamond flush



LED potters clay flush



LED shark skin flush

*Cabin Height required > H. 2100 mm due to suspended ceiling.

ADDITIONAL SKIN PLATES

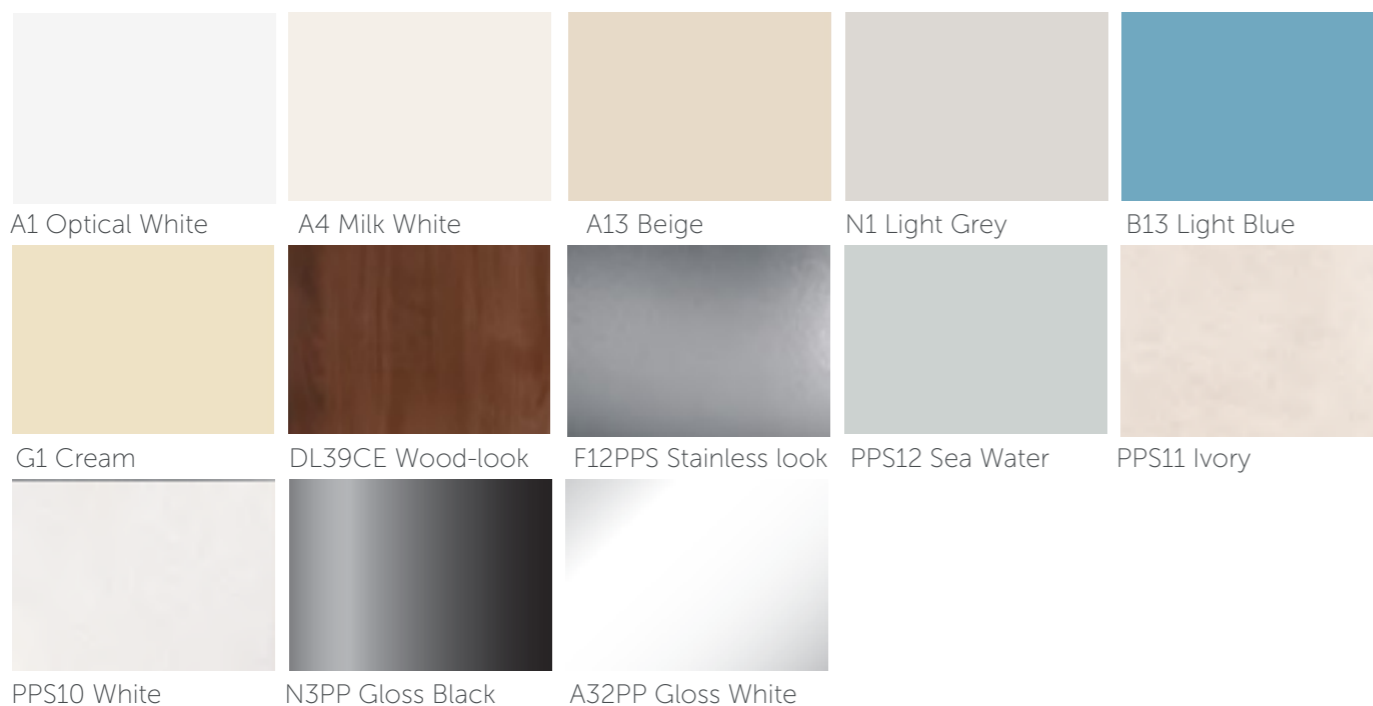

PLASTIC LAMINATE FOR SUPERIOR

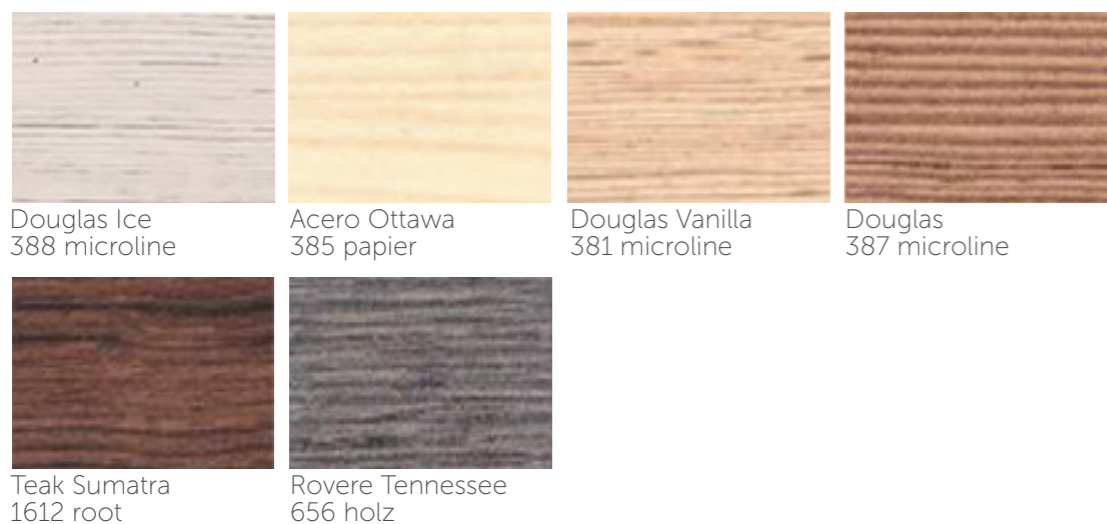

WOOD, STEEL & FABRIC-LOOK FOR EXCLUSIVE



TEXTILE MATT FINISH OPTIONAL

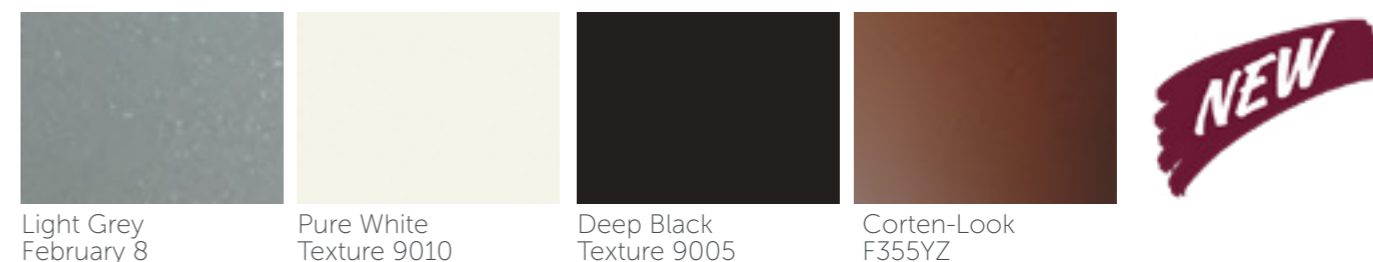

RAL COLOURS BASIC



STAINLESS STEEL ON REQUEST

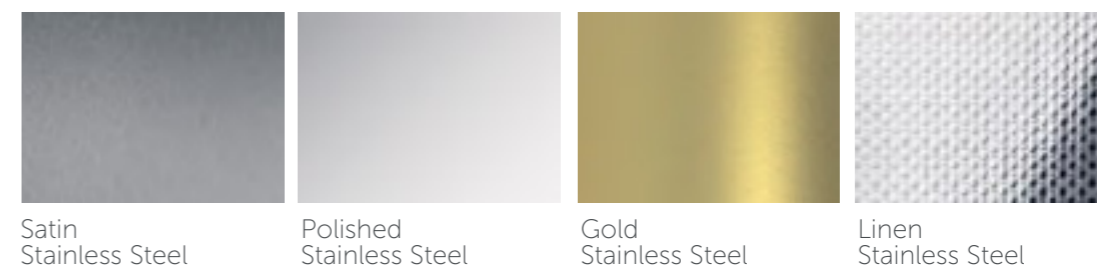

A DECADE OF PRIDE AND EXCELLENT SERVICE..

We are passionate about providing a high-quality home lifts and mobility solutions to improve everyday lives.

We have our offices in Sydney, Coffs Harbour, Brisbane and affiliated partners across Australia to handle the demand for our services.

We have a team of experts who will be with you every step of the way, from quoting to installation. They'll take care of everything in between so that your lift has all it needs for years into the future!

5.0 STAR RATING



DIRECT LIFTS
AUSTRALIA

We're so proud to say that our **5-star rating** on Google is proof of excellent service and top-tier installation.

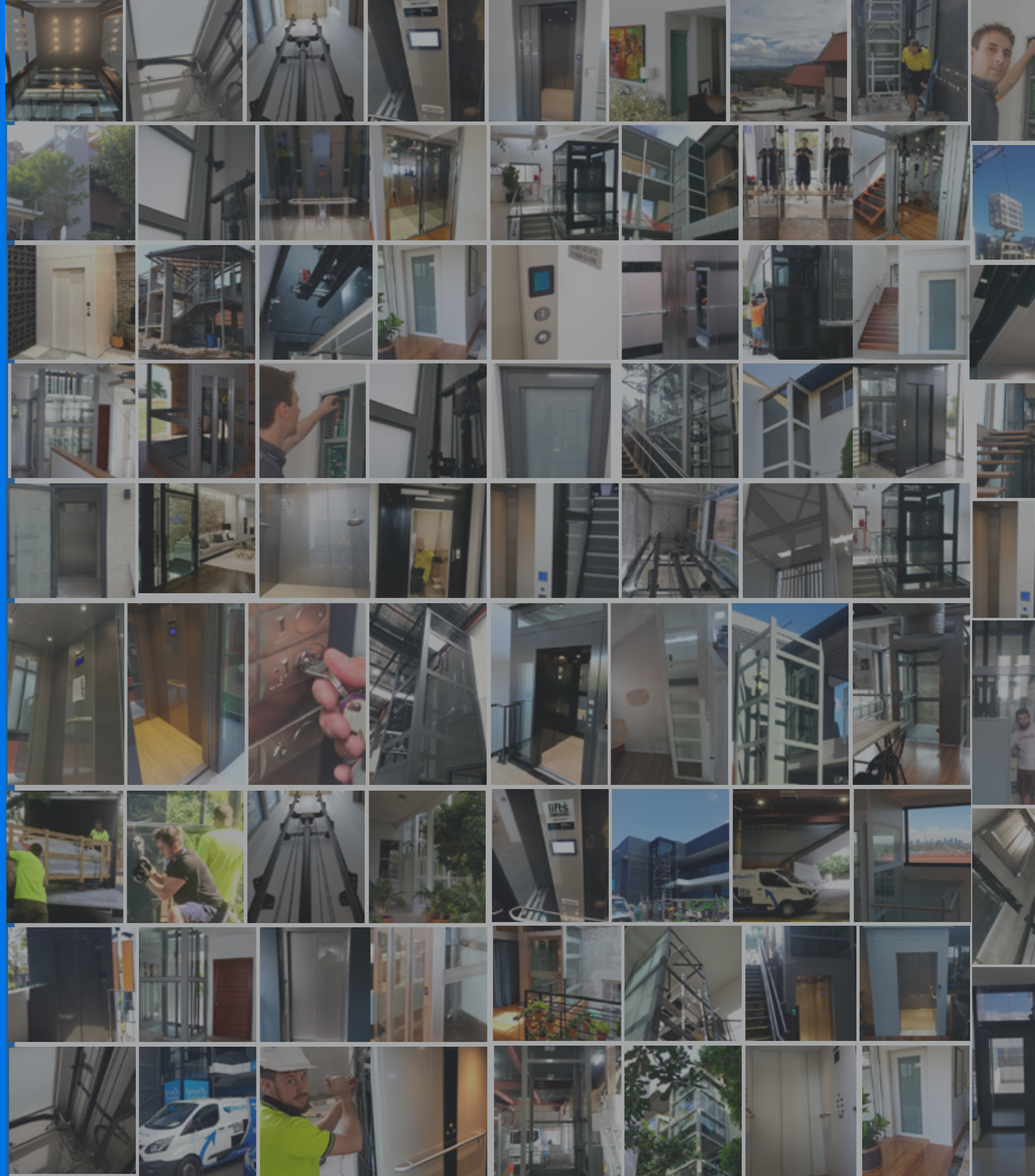

HOME LIFT INSTALLS

SYDNEY **BRISBANE**

We're ready to make your lift installation dreams come true. We have been installing elevators for more than a decade and can help you with any needs, from residential homes up to buildings that need commercial lifts installed. **Check out some of the recent projects below...**



Cabarita, NSW



Kenmore, QLD



Kings Beach, QLD
Super Panoramic
w/ frosted glass door.



Cabarita, NSW



Cabarita, NSW



Corinda, Brisbane



Greenwich, NSW

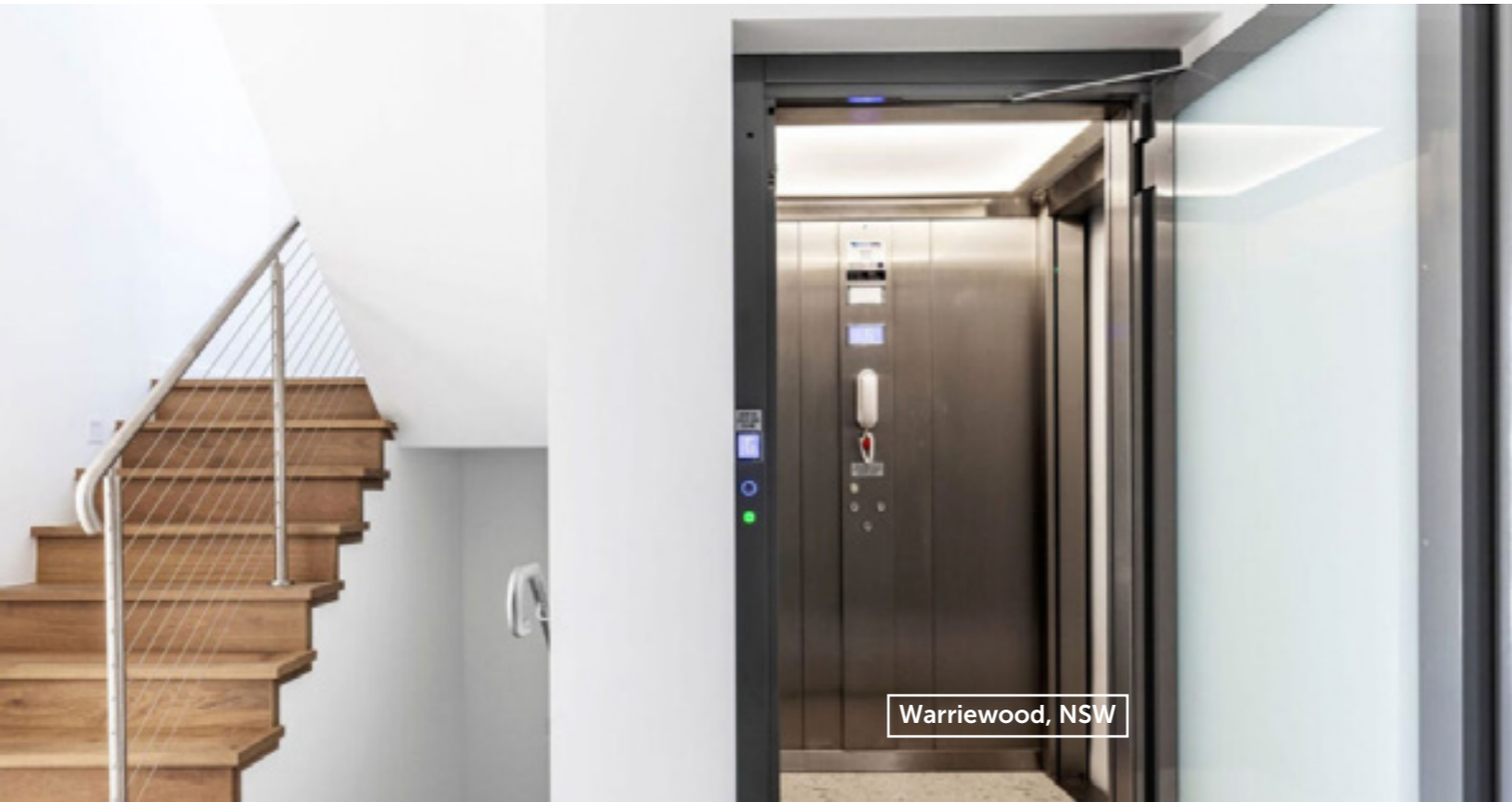

Warriewood, NSW



Newport, QLD



Banksia, NSW



Lake Macquarie



Wentworth Ave, NSW



Brisbane hills, QLD
Panoramic glass door
w/ glazing in the shaft



Dicky Beach, Brisbane



Project in NSW



Corinda, Brisbane



Waterloo, NSW



Erina, NSW



Chatswood, NSW



OFFICES/SHOWROOMS

BNE HQ: 43 Telford St, Virginia QLD 4014

SYD Unit 8/20-28 Ricketty Street, Mascot, NSW 2020

CFS 6/8-10 Industrial Drv Coffs Harbour NSW 2450
(By Appointment)

**directlifts**
AUSTRALIA