

DECOREAGLE INSTALLATION GUIDELINES

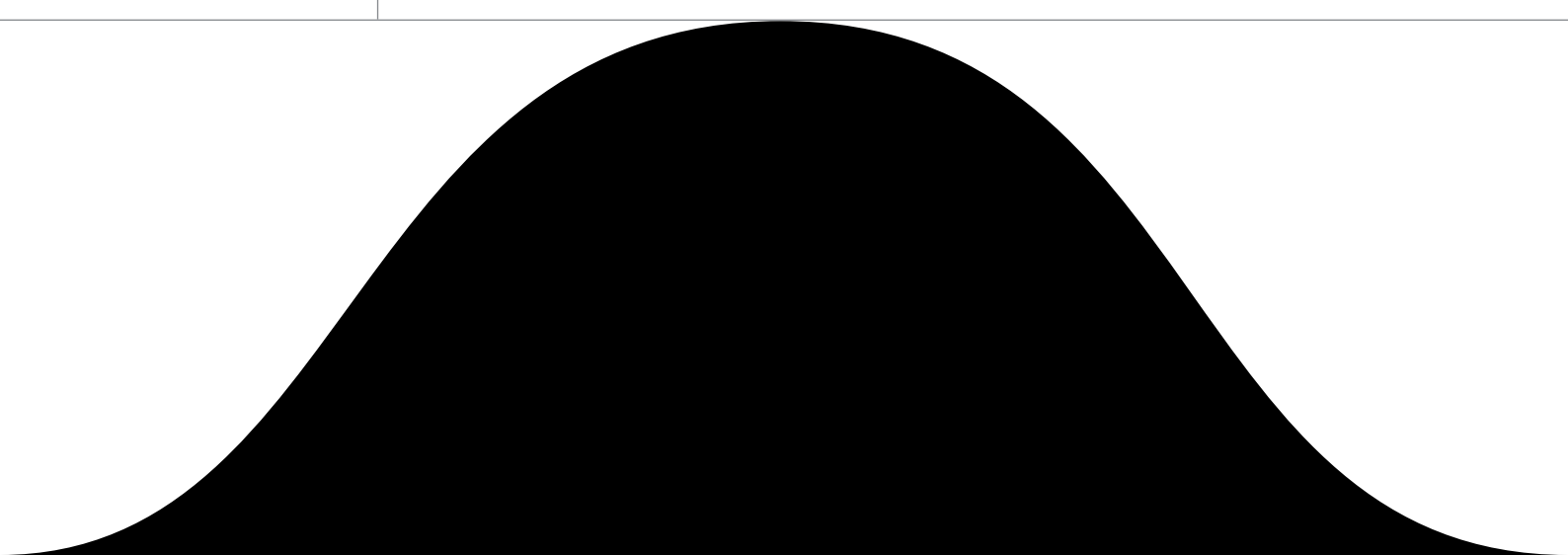

CONTENTS

PRE INSTALLATION _____ 3

BLIND SLOT

3D _____ 5

2D _____ 6

DSB FIXING

3D _____ 7

2D _____ 8

BJ2 FIXING

3D _____ 9

2D _____ 10

GET IN TOUCH _____ 11

PRE INSTALLATION

ACCLIMATISATION

Panels need to acclimatise to the environment before installation. Please contact your local Decor Systems representative for more information.

DECOR SYSTEMS CARE & MAINTENANCE

INTRODUCTION

This panels system is a highly durable modular wall and ceiling panelling system that is factory finished. Substrates include MDF, plywood and fibre cement.

CARE AND MAINTENANCE

General Regular Cleaning

This is best carried out with a sponge or soft cloth and any household cleaning detergents. Abrasive cleaning agents must not be used.

Polishing

The product is suitable for polishing with a soft cloth if required.

Graffiti Removal

Pressure pack (ie. Paint) damage is usually easily removed by wiping with mineral turpentine saturated rag within 48 hours of application.

Felt tipped marker damage should be removed using methylated spirits- again, within 48 hours.

Mechanical Damage

Should the panels be physically scored, chipped or scraped in any way please consult Decor Systems for the best method of repair/replacement.

Scratch damage can usually be repaired simply by the application of the topcoat colour (available from the manufacturer) using a fine camel hairbrush.

DISCLAIMER: ANY ADVICE, RECOMMENDATIONS, INFORMATION, ASSISTANCE OR SERVICE PROVIDED BY DECOR SYSTEMS IN RELATION TO GOODS MANUFACTURED BY IT OR THEIR USE AND APPLICATION IS GIVEN IN GOOD FAITH AND BELIEVED BY DECOR SYSTEMS TO BE APPROPRIATE AND RELIABLE. SINCE THE USE AND APPLICATION OF THIS PRODUCT IS BEYOND OUR CONTROL WE CANNOT BE HELD RESPONSIBLE FOR PRODUCT FIELD PERFORMANCE. THE INFORMATION PRESENTED ABOVE IS THE RESULT OF OUR CONSIDERABLE EXPERIENCE WITH THIS PRODUCT BUT IS NOT TO BE CONSTRUED AS A PERFORMANCE WARRANTY

DECOREAGLE INSTALLATION DETAIL
BLIND SLOT FIXING METHOD
 Wall or Ceiling Application

- FRAMING:
- WALL AND CEILING FURRING CHANNEL FRAMING BY OTHERS
 - RECOMMENDATION FURRING CHANNELS AT 400MM CENTRES

- HARDWARE:
- RECOMMENDATION OF 600MM CENTRES

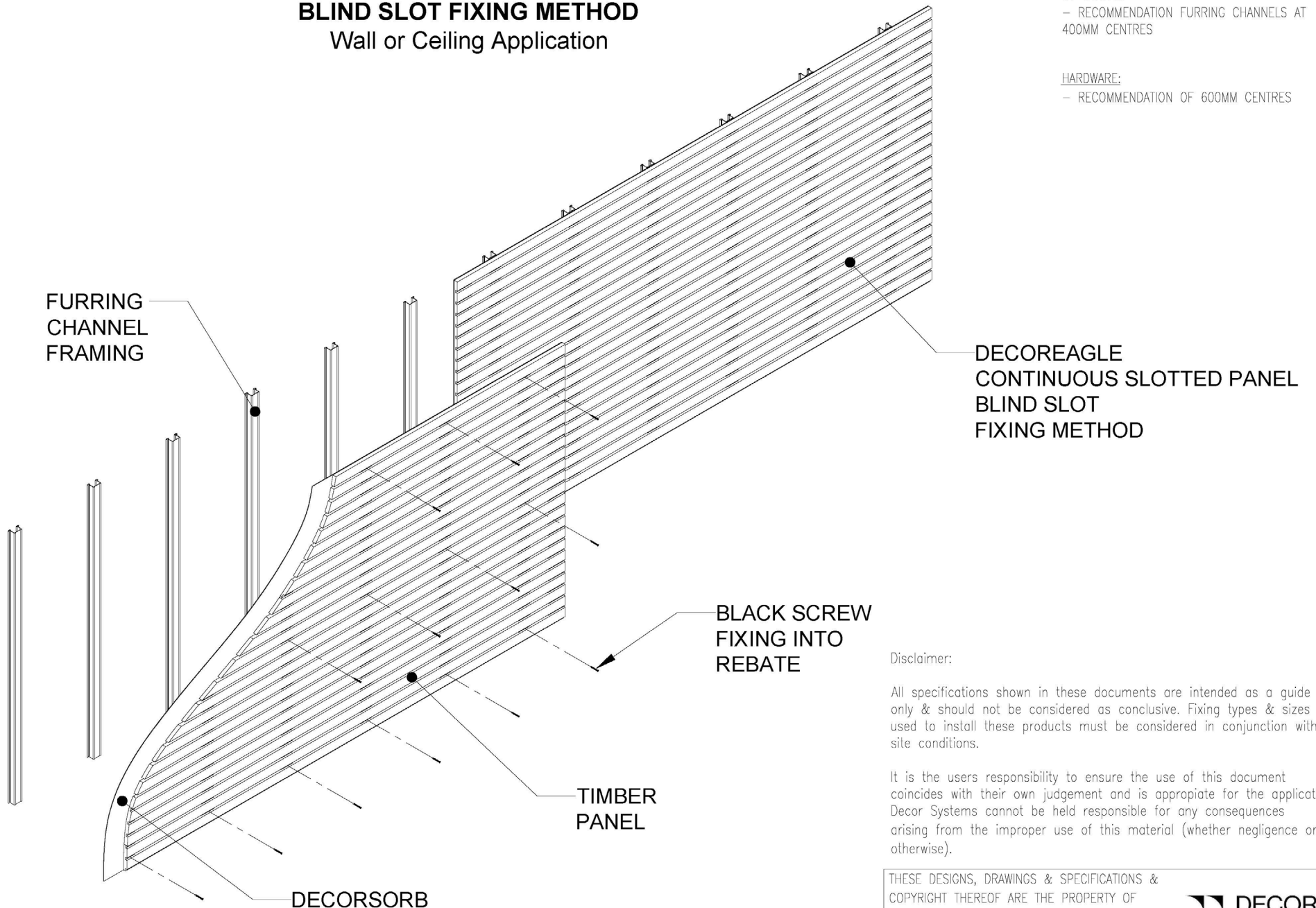

**DECOREAGLE
 CONTINUOUS SLOTTED PANEL
 BLIND SLOT
 FIXING METHOD**

**BLACK SCREW
 FIXING INTO
 REBATE**

**TIMBER
 PANEL**

DECORSORB

Disclaimer:

All specifications shown in these documents are intended as a guide only & should not be considered as conclusive. Fixing types & sizes used to install these products must be considered in conjunction with site conditions.

It is the users responsibility to ensure the use of this document coincides with their own judgement and is appropriate for the application. Decor Systems cannot be held responsible for any consequences arising from the improper use of this material (whether negligence or otherwise).

THESE DESIGNS, DRAWINGS & SPECIFICATIONS &
 COPYRIGHT THEREOF ARE THE PROPERTY OF
 DECOR SYSTEMS AUSTRALIA & MUST NOT BE
 USED, RETAINED OR COPIED WITHOUT THE WRITTEN
 AUTHORITY OF DECOR SYSTEMS AUSTRALIA.



BLIND SLOT 3D

DECOREAGLE INSTALLATION DETAIL
BLIND SLOT FIXING METHOD
 Wall or Ceiling Application

FRAMING:
 - WALL AND CEILING FURRING CHANNEL FRAMING BY OTHERS
 - RECOMMENDATION FURRING CHANNELS AT 400MM CENTRES

HARDWARE:
 - RECOMMENDATION OF 600MM CENTRES

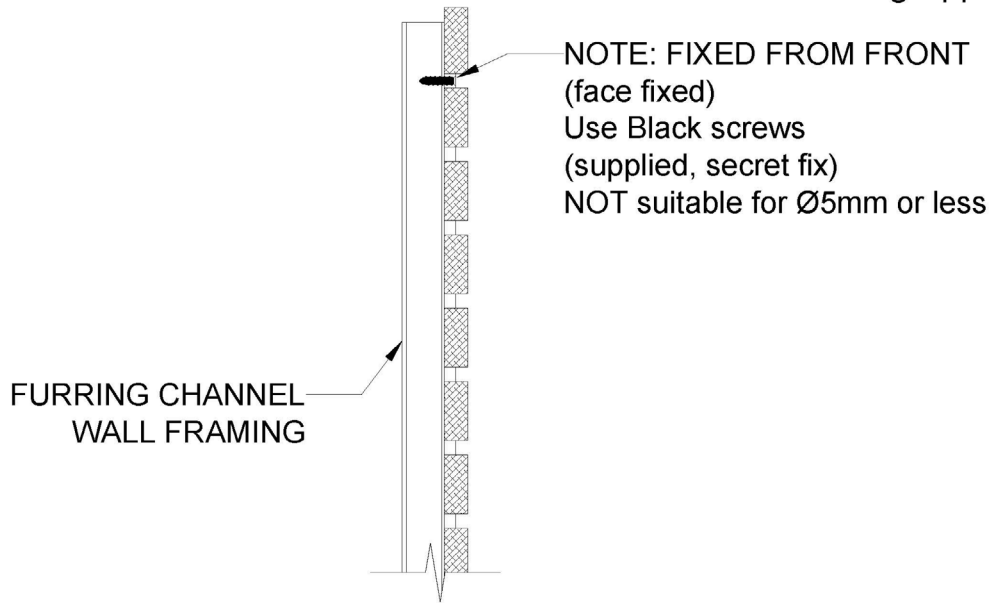

SECRET SCREW FIX TO WALL FRAMING

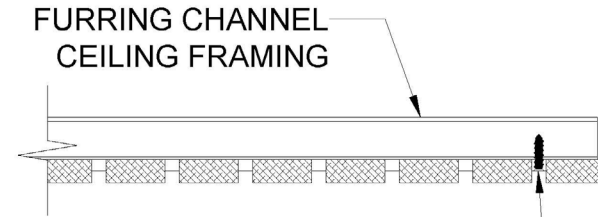

NOTE: FIXED FROM FRONT (face fixed)
 Use Black screws (supplied, secret fix)
 NOT suitable for Ø5mm or less

SECRET SCREW FIX TO CEILING FRAMING

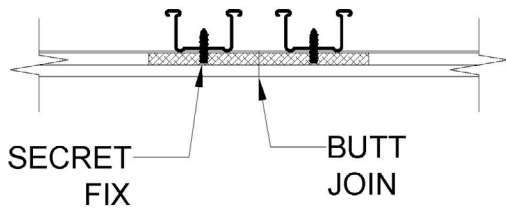

END TO END BUTT JOIN

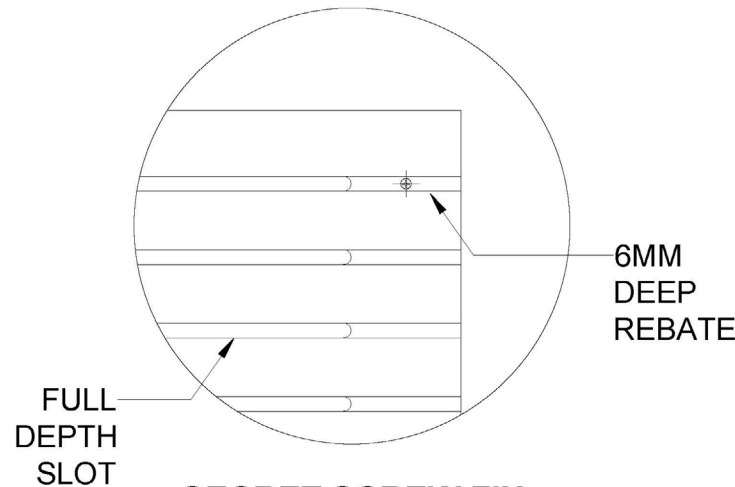

SECRET SCREW FIX FACE VIEW

Disclaimer:

All specifications shown in these documents are intended as a guide only & should not be considered as conclusive. Fixing types & sizes used to install these products must be considered in conjunction with site conditions.

It is the users responsibility to ensure the use of this document coincides with their own judgement and is appropriate for the application. Decor Systems cannot be held responsible for any consequences arising from the improper use of this material (whether negligence or otherwise).

THESE DESIGNS, DRAWINGS & SPECIFICATIONS & COPYRIGHT THEREOF ARE THE PROPERTY OF DECOR SYSTEMS AUSTRALIA & MUST NOT BE USED, RETAINED OR COPIED WITHOUT THE WRITTEN AUTHORITY OF DECOR SYSTEMS AUSTRALIA.



DECOREAGLE INSTALLATION DETAIL
DSB FIXING METHOD
 Wall or Ceiling Application

FRAMING:
 - WALL AND CEILING FURRING CHANNEL FRAMING
 BY OTHERS
 - RECOMMENDATION FURRING CHANNELS AT
 400MM CENTRES

HARDWARE:
 - RECOMMENDATION OF 600MM CENTRES

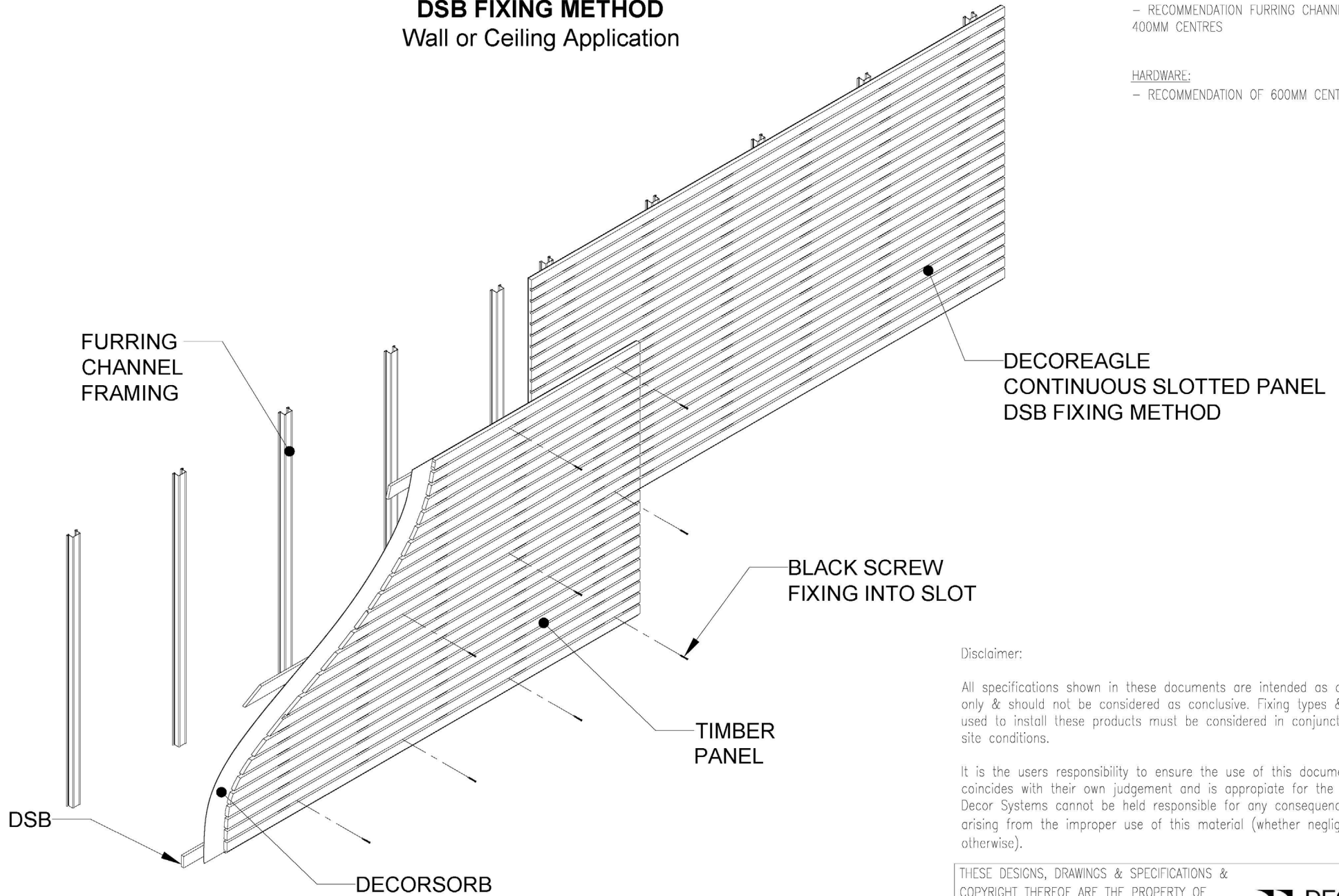

Disclaimer:

All specifications shown in these documents are intended as a guide only & should not be considered as conclusive. Fixing types & sizes used to install these products must be considered in conjunction with site conditions.

It is the users responsibility to ensure the use of this document coincides with their own judgement and is appropriate for the application. Decor Systems cannot be held responsible for any consequences arising from the improper use of this material (whether negligence or otherwise).

THESE DESIGNS, DRAWINGS & SPECIFICATIONS & COPYRIGHT THEREOF ARE THE PROPERTY OF DECOR SYSTEMS AUSTRALIA & MUST NOT BE USED, RETAINED OR COPIED WITHOUT THE WRITTEN AUTHORITY OF DECOR SYSTEMS AUSTRALIA.



DSB FIXING 3D

DECOREAGLE INSTALLATION DETAIL
DSB FIXING METHOD
 Wall or Ceiling Application

FRAMING:
 - WALL AND CEILING FURRING CHANNEL FRAMING BY OTHERS
 - RECOMMENDATION FURRING CHANNELS AT 400MM CENTRES

HARDWARE:
 - RECOMMENDATION OF 600MM CENTRES

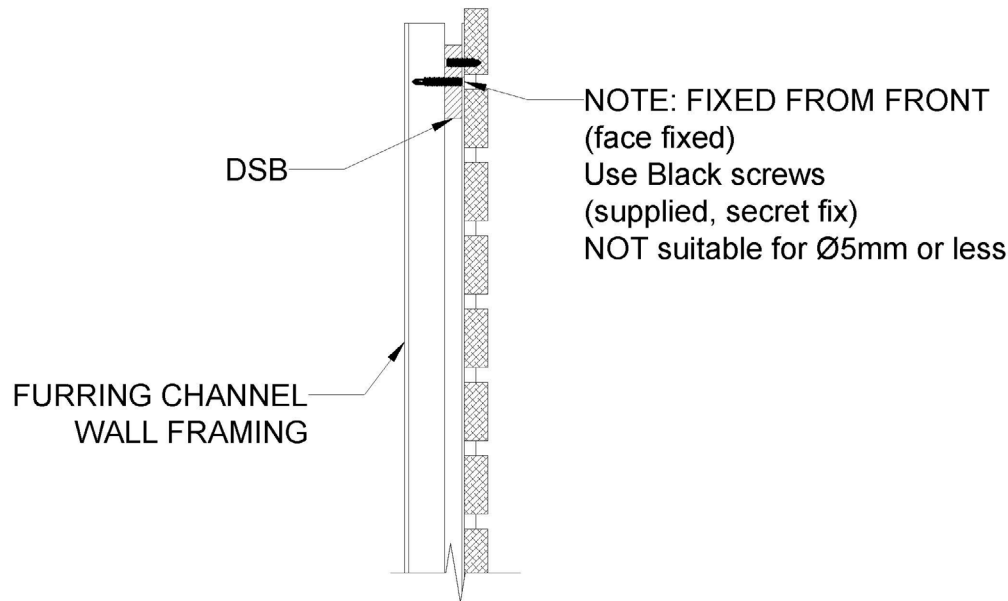

NOTE: FIXED FROM FRONT (face fixed)
 Use Black screws (supplied, secret fix)
 NOT suitable for Ø5mm or less

FURRING CHANNEL WALL FRAMING

SECRET SCREW FIX TO WALL FRAMING

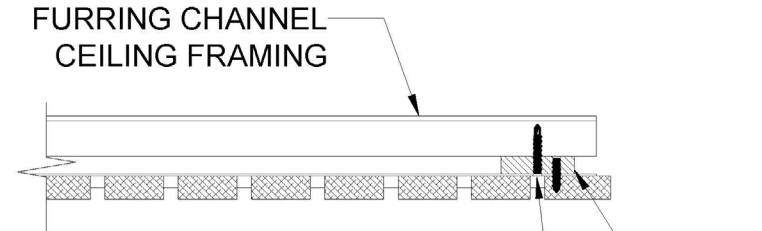

NOTE: FIXED FROM FRONT (face fixed)
 Use Black screws (supplied, secret fix)
 NOT suitable for Ø5mm or less

SECRET SCREW FIX TO CEILING FRAMING

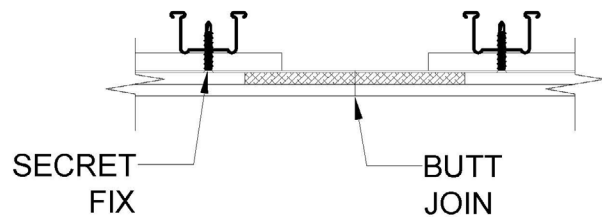

END TO END BUTT JOIN

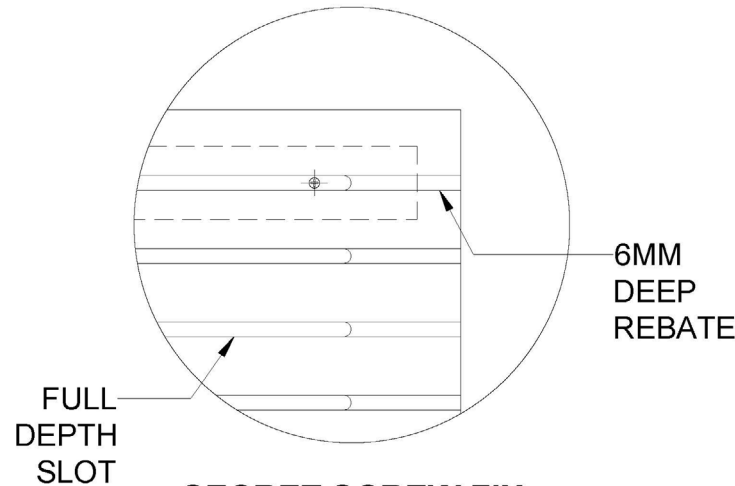

SECRET SCREW FIX FACE VIEW

Disclaimer:

All specifications shown in these documents are intended as a guide only & should not be considered as conclusive. Fixing types & sizes used to install these products must be considered in conjunction with site conditions.

It is the users responsibility to ensure the use of this document coincides with their own judgement and is appropriate for the application. Decor Systems cannot be held responsible for any consequences arising from the improper use of this material (whether negligence or otherwise).

THESE DESIGNS, DRAWINGS & SPECIFICATIONS & COPYRIGHT THEREOF ARE THE PROPERTY OF DECOR SYSTEMS AUSTRALIA & MUST NOT BE USED, RETAINED OR COPIED WITHOUT THE WRITTEN AUTHORITY OF DECOR SYSTEMS AUSTRALIA.



DECOREAGLE INSTALLATION DETAIL
BJ2 FIXING METHOD
 Wall Application Only

- FRAMING:
- WALL AND CEILING FURRING CHANNEL FRAMING BY OTHERS
 - RECOMMENDATION FURRING CHANNELS AT 400MM CENTRES
 - RECOMMENDATION BJ2 SPLIT BATTEN AT 600MM CENTRES
- HARDWARE:
- RECOMMENDATION OF 600MM CENTRES

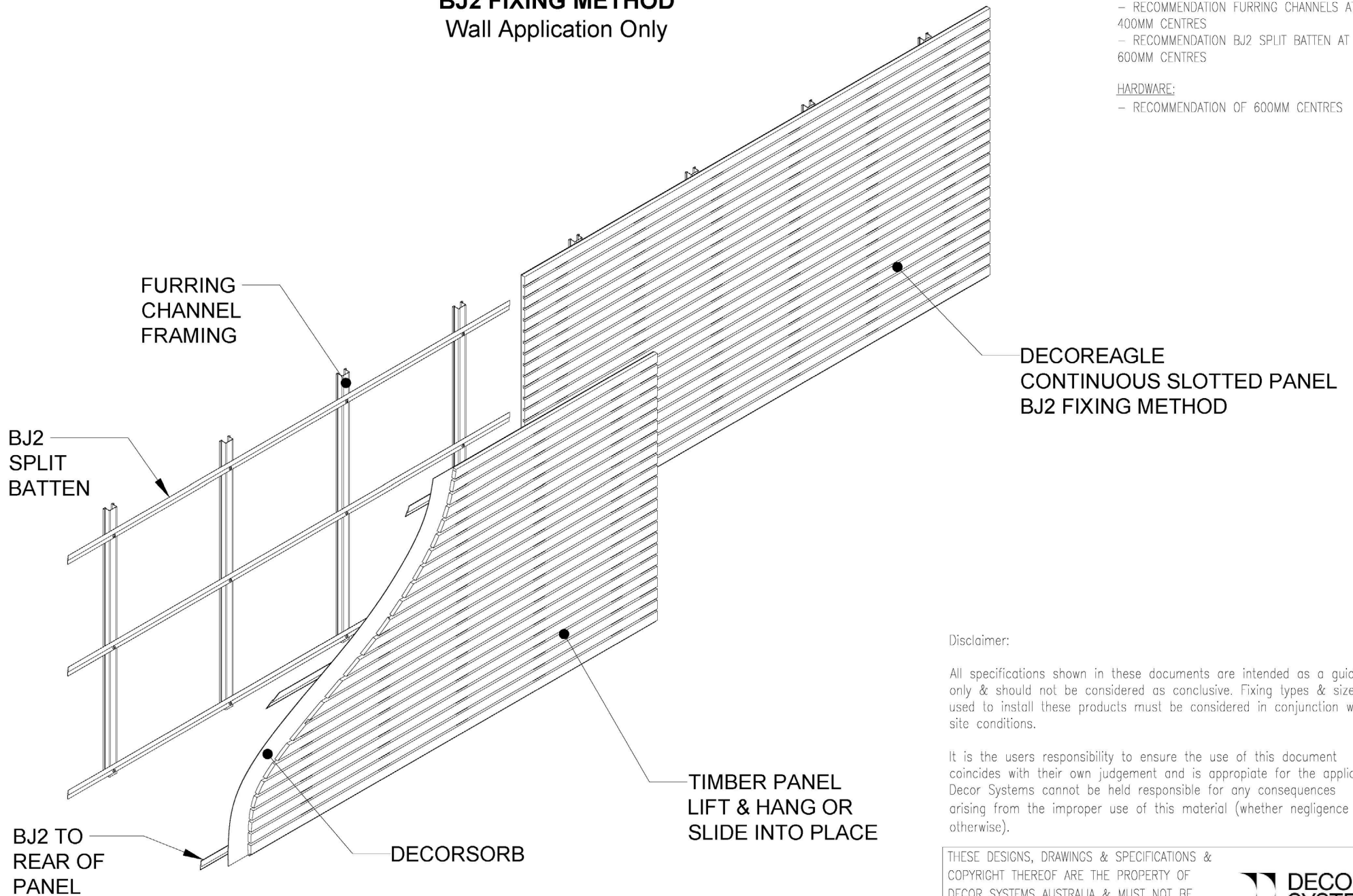

Disclaimer:

All specifications shown in these documents are intended as a guide only & should not be considered as conclusive. Fixing types & sizes used to install these products must be considered in conjunction with site conditions.

It is the users responsibility to ensure the use of this document coincides with their own judgement and is appropriate for the application. Decor Systems cannot be held responsible for any consequences arising from the improper use of this material (whether negligence or otherwise).

THESE DESIGNS, DRAWINGS & SPECIFICATIONS & COPYRIGHT THEREOF ARE THE PROPERTY OF DECOR SYSTEMS AUSTRALIA & MUST NOT BE USED, RETAINED OR COPIED WITHOUT THE WRITTEN AUTHORITY OF DECOR SYSTEMS AUSTRALIA.



BJ2 FIXING 3D

DECOREAGLE INSTALLATION DETAIL
BJ2 FIXING METHOD
 Wall Application Only

- FRAMING:
- WALL AND CEILING FURRING CHANNEL FRAMING BY OTHERS
 - RECOMMENDATION FURRING CHANNELS AT 400MM CENTRES
 - RECOMMENDATION BJ2 SPLIT BATTEN AT 600MM CENTRES

- HARDWARE:
- RECOMMENDATION OF 600MM CENTRES

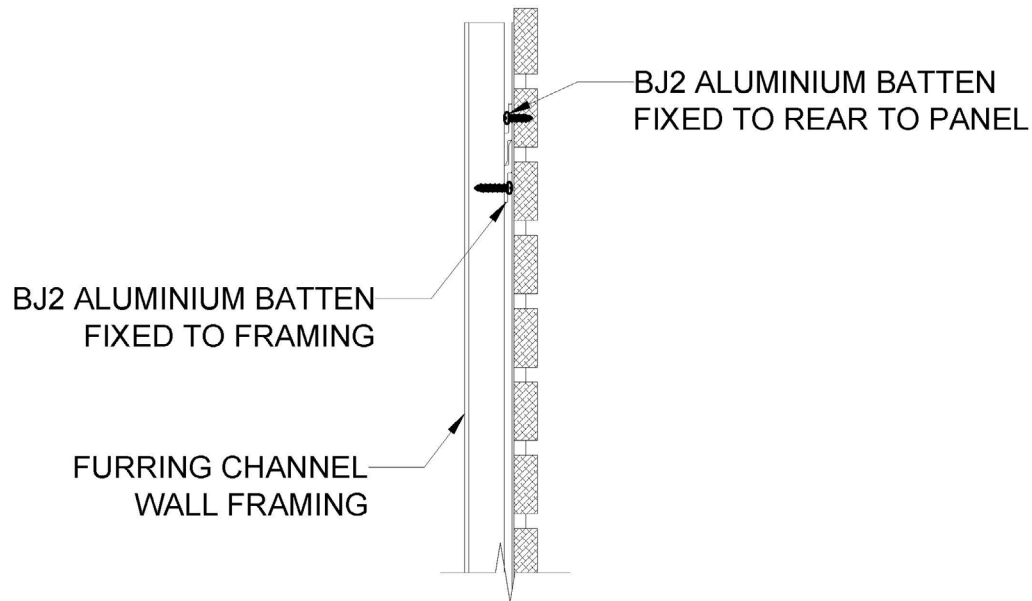

SECRET BJ2 FIX
WALL FRAMING

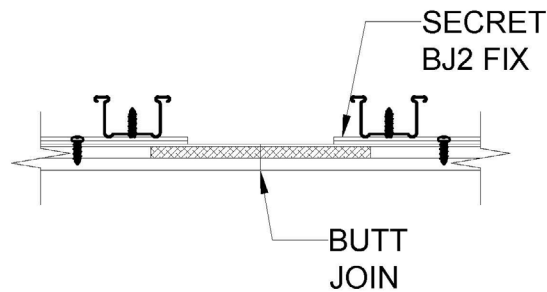

END TO END
BUTT JOINT

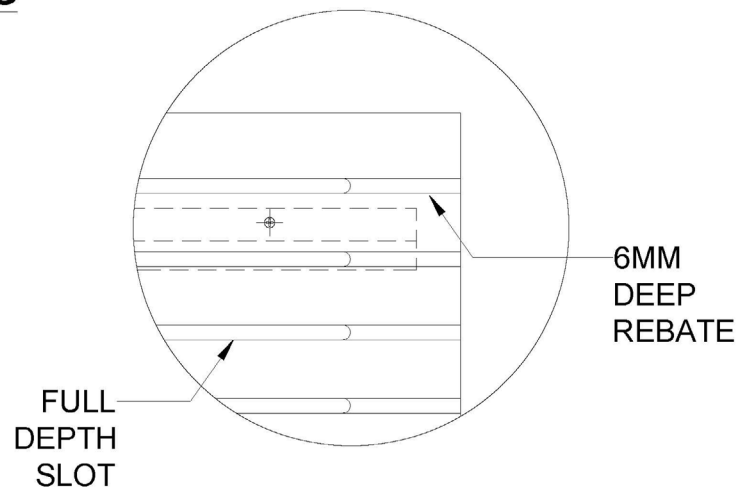

SECRET FIX
Fixed from Rear

Disclaimer:

All specifications shown in these documents are intended as a guide only & should not be considered as conclusive. Fixing types & sizes used to install these products must be considered in conjunction with site conditions.

It is the users responsibility to ensure the use of this document coincides with their own judgement and is appropriate for the application. Decor Systems cannot be held responsible for any consequences arising from the improper use of this material (whether negligence or otherwise).

THESE DESIGNS, DRAWINGS & SPECIFICATIONS & COPYRIGHT THEREOF ARE THE PROPERTY OF DECOR SYSTEMS AUSTRALIA & MUST NOT BE USED, RETAINED OR COPIED WITHOUT THE WRITTEN AUTHORITY OF DECOR SYSTEMS AUSTRALIA.



GET IN TOUCH

CONTACT

[1800 835 035](tel:1800835035)

letstalk@decorsystems.com.au



DECORSYSTEMS.COM.AU