

caroma®
design for *life*

TAPWARE RANGE



TAPS

MIXERS

ACCESSORIES

SHOWERS

Caroma – Taps and bathroom accessories to inspire you

If you want some inspirational ideas for your bathroom, kitchen or laundry, make Caroma part of your plans. All Caroma taps, mixers, showers and accessories have that rare combination of sophistication, classic styling and timeless design. Caroma products not only look great, they are also designed to save precious water resources, providing the complete package for your home.

Taps

- Liano, Starlite 3
- Trident Lever & Cross, Lusso Lever & Cross 4
- Midas 5
- Care 12

Mixers

- Track 5
- Liano, Nordic 6
- Opus, Acqua 7
- Care 12

Accessories

- Track, Liano 8
- Cosmo, Midas 9

Showers

- Rain, Rail, Hand & Adjustable 10
- Shower Systems, Fixed & Spray Patterns 11

Technical Details

- Diagrams and specifications 13-19



Check the specific certification on the product packaging for full details



* These products are not included in the WELS scheme and therefore are not star rated. They are excluded from the scheme as the water they use is limited to the capacity of the bath or washing machine. † Washing Machine Sets do not use ceramic disc cartridges.

Liano TAPS

A combination of timeless lines with simple right angles. Liano is the essence of minimalist design

- Modern cylindrical shape for easy clean and care
- Hard wearing, low maintenance solid brass construction
- Ceramic disc cartridge eliminates drips and minimises maintenance
- Also available: hob bath/spa set*, wall top assemblies* (horizontal or vertical platemount options available), washing machine set**†, basin top assemblies*
- Matching basins and accessories available



BASIN SET - WELS 5 STAR RATED



SHOWER SET - WELS 3 STAR RATED

WALL SINK SET - WELS 4 STAR RATED

BATH SET*
(PLATEMOUNT VERSION AVAILABLE)

Starlite TAPS

Its elegant rounded shape offers a subtle blend of softness and serenity

- Striking chrome finish
- Swivel basin and wall sink outlets offer greater water control
- Adjustable showerhead features 5 spray patterns & patented Stayfast® shower arm locks
- Bottom fixed taps and outlets for easy care
- Also available: washing machine set**†, wall top assemblies*



BASIN SET - WELS 5 STAR RATED



SHOWER SET - WELS 3 STAR RATED

WALL SINK SET - WELS 4 STAR RATED

BATH SET*

TRIDENT LEVER & CROSS TAPS

Classic styling, with two choices in handle design. Trident fits perfectly into both traditional or contemporary homes

- Universal, classic design with polished chrome finish
- Trident Lever features a ceramic disc cartridge for smooth, low maintenance operation & patented Stayfast® shower arm locks in place
- Swivel basin and wall sink outlets offer greater water control
- Hard wearing solid brass construction
- Also available: washing machine set (lever & cross)*†, hob sink set (cross) - WELS 4 star rated, pillar tap set (cross) - WELS 5 star rated, wall top assemblies (lever & cross)*, basin top assemblies (lever)*



BASIN SET (LEVER) - WELS 5 STAR RATED

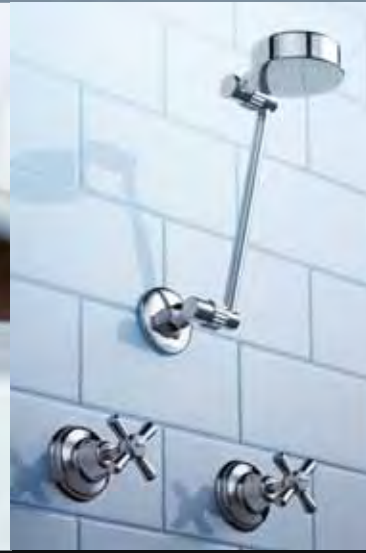

SHOWER SET (CROSS) - WELS 3 STAR RATED

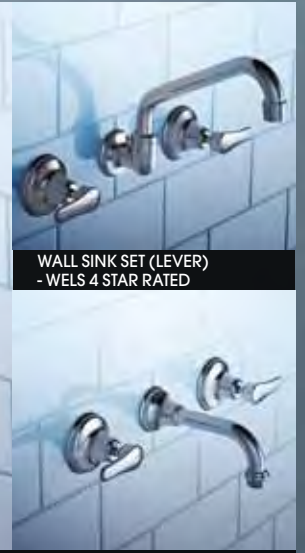

WALL SINK SET (LEVER)
- WELS 4 STAR RATED

BATH SET (LEVER)*

All products pictured are available with cross or lever style handles.

LUSO LEVER & CROSS TAPS

Geometrically graceful, visually arresting. Stunning cross handle or simple lever styles make Lusso easy to look at and smooth to operate

- Hard wearing, low maintenance solid brass construction
- Striking chrome finish
- Smooth lines for easy clean and care
- Lusso Lever features ceramic disc cartridge, eliminates drips and minimises maintenance - optional for cross handle
- Also available: hob sink set (lever & cross) - WELS 4 star rated, wall basin set (lever & cross) - WELS 5 star rated



BASIN SET (LEVER) - WELS 5 STAR RATED



SHOWER SET (CROSS) - WELS 3 STAR RATED

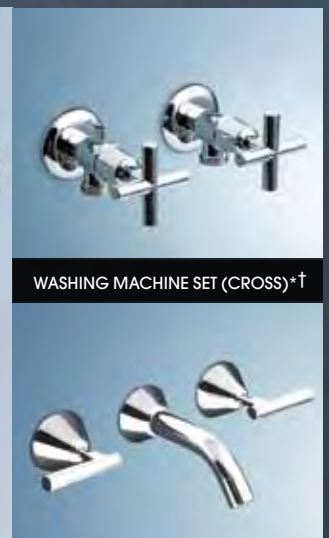

WASHING MACHINE SET (CROSS)*†

BATH SET (LEVER)*

All products pictured are available with cross or lever style handles.

Midas TAPS

A classic design with universal appeal that adds the midas touch to your bathroom

- Hard wearing, low maintenance, solid brass construction
- Striking chrome finish
- Swivel basin outlet
- Cross handle styling for ease of operation
- Patented Stayfast® shower arm locks in place
- Copper jumper valve allows ease of use and long term performance



BASIN SET - WELS 5 STAR RATED



SHOWER SET - WELS 3 STAR RATED



BATH SET*



WALL TOP ASSEMBLY*



WASHING MACHINE SET*†

Track MIXERS

Track mixers and showers will elevate the feel of any bathroom. Choose the clean, contemporary European design without the European price

- Features an adjustable internal cartridge for ongoing water and energy savings
- Bold designer styling
- Water saving tapware without compromising on performance
- Also available: bath/shower mixer with diverter*, a variety of shower options
- Matching accessories available from late 2010



BASIN MIXER - WELS 5 STAR RATED



WALL BASIN MIXER*



BATH OUTLET*



SINK MIXER - WELS 4 STAR RATED



BATH/SHOWER MIXER*

Liano MIXERS

Proudly Australian designed, this premium mixer range is guaranteed to meet the latest interior design trends. Its unique lever operation means easy and effortless water control

- Hard wearing, low maintenance solid brass construction
- Ceramic disc cartridge eliminates drips and minimises maintenance
- Modern cylindrical shape for easy clean and care
- Also available: wall sink mixer - WELS 4 star rated, wall basin mixer - WELS 5 star rated, bath/shower mixer w/rectangular plate* (with or without diverter), hob mixer*
- Matching basins, showers and accessories available



BASIN MIXER - WELS 5 STAR RATED



SINK MIXER - WELS 4 STAR RATED



BATH MIXER*



BATH/SHOWER MIXER W/ROUND PLATE*

Nordic MIXERS

A timeless design with a practical approach, Nordic mixers are designed with the whole family in mind

- Ideal for use by children with its pre-set temperature and flow settings
- Temperature limiting device saves energy
- Econoflow system reduces water consumption as maximum water flow is only achieved when the handle is lifted to its uppermost position
- Smoothly contoured lever for easy operation
- Extended lever handle option available for those with weaker hand mobility
- Also available: sink mixer (150mm) - WELS 4 star rated



BASIN MIXER - WELS 5 STAR RATED



BATH/SHOWER MIXER*



BIDETTE MIXER*



BATH/SHOWER MIXER W/DIVERTER*



SINK MIXER (240MM) - WELS 4 STAR RATED

Opus MIXERS

Cleverly designed with you in mind, Opus is a smart combination of performance and appeal

- Temperature and flow settings can be pre-set to save water and energy
- Long life, soft close cartridge reduces noisy water hammer
- Econoflow system reduces water consumption as maximum water flow is only achieved when the handle is lifted to its uppermost position
- Ergonomic, easy grip handle
- Hard wearing, solid brass construction
- Also available: sink mixer (150mm) - WELS 4 star rated



BASIN MIXER - WELS 5 STAR RATED



BATH/SOWER MIXER*

BIDETTE MIXER*

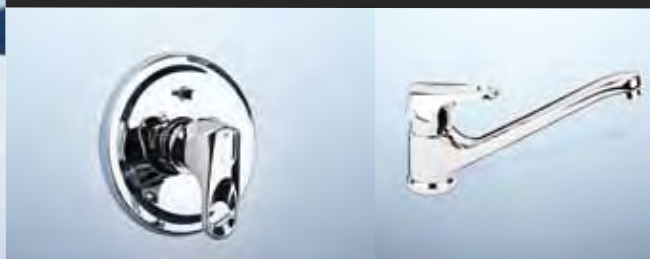

BATH/SOWER MIXER W/DIVERTER*

SINK MIXER (240MM)
- WELS 4 STAR RATED

Acqua MIXERS

A quality mixer from a trusted Australian brand, Acqua delivers affordable style and value

- Classic, easy clean design
- Chrome finish for easy co-ordination and durability
- Hard wearing, low maintenance solid brass construction
- Ergonomic, easy grip handle design
- Sink mixer features swivel outlet



BASIN MIXER - WELS 5 STAR RATED

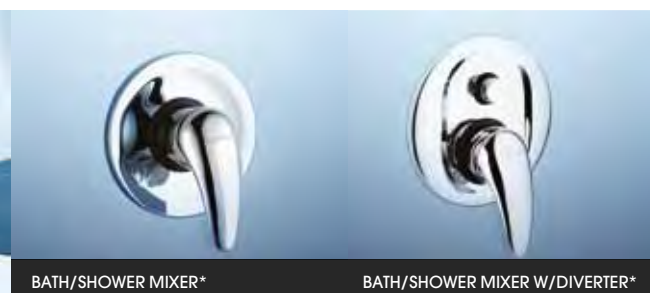

BATH/SOWER MIXER*

BATH/SOWER MIXER W/DIVERTER*



SINK MIXER - WELS 4 STAR RATED

Track ACCESSORIES **NEW**

With a dramatic European designer look, Track accessories are a stylish and functional addition to any modern bathroom

- Premium chrome finish
- Solid brass construction
- Designed to complement the Track mixer collection
- Available late 2010



Liano ACCESSORIES

Liano offers an uncomplicated and minimalist feel, adding timeless sophistication to your bathroom

- Solid metal components for a long life
- Designed to complement the Liano tap, mixer, shower and basin collection
- Also available: spare toilet roll holder

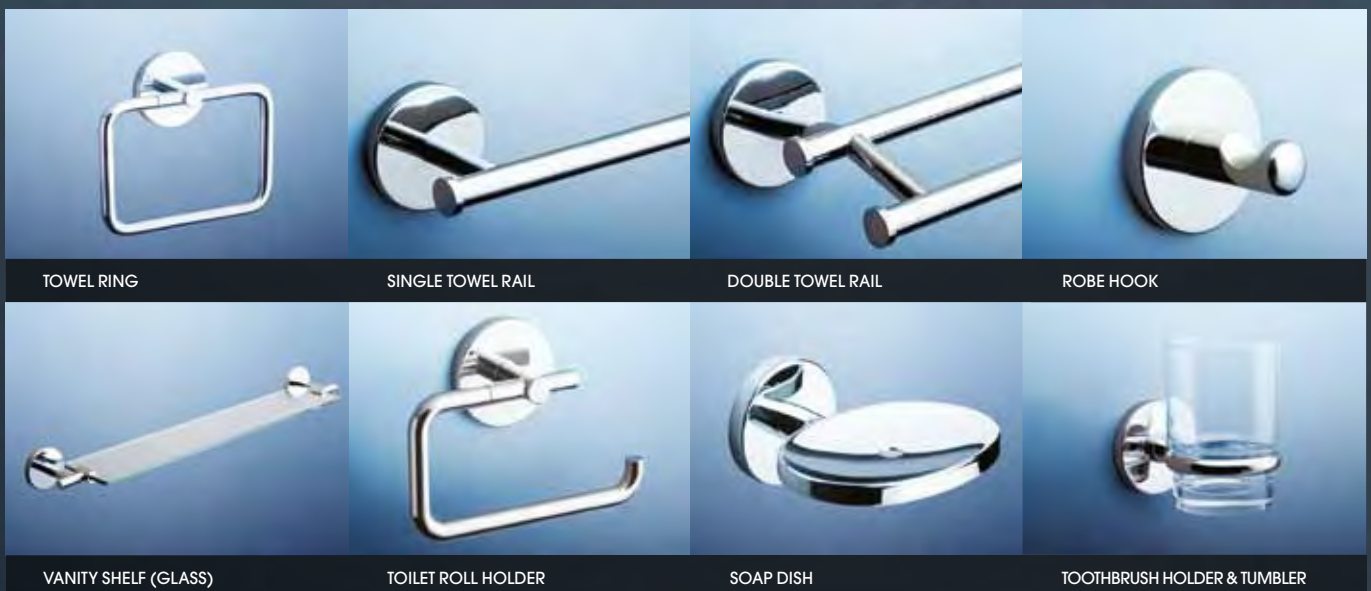

Cosmo ACCESSORIES

An extensive selection with a contemporary design at a surprisingly affordable price. Cosmo accessories create the perfect finishing touch for any bathroom

- Designed to complement the Cosmo basin and toilet suite collection
- Metal construction ensures durability
- Also available: double towel swinging arm rail, towel rack, hand towel rail (250mm), soap basket, glass shelf - single, toilet brush and holder



Visit www.caroma.com.au to view the entire Cosmo collection

Midas ACCESSORIES

A classic design with universal appeal that adds the midas touch to your bathroom

- Durable metal construction
- Complements both contemporary and traditional style bathrooms
- Extensive selection for a coordinated bathroom

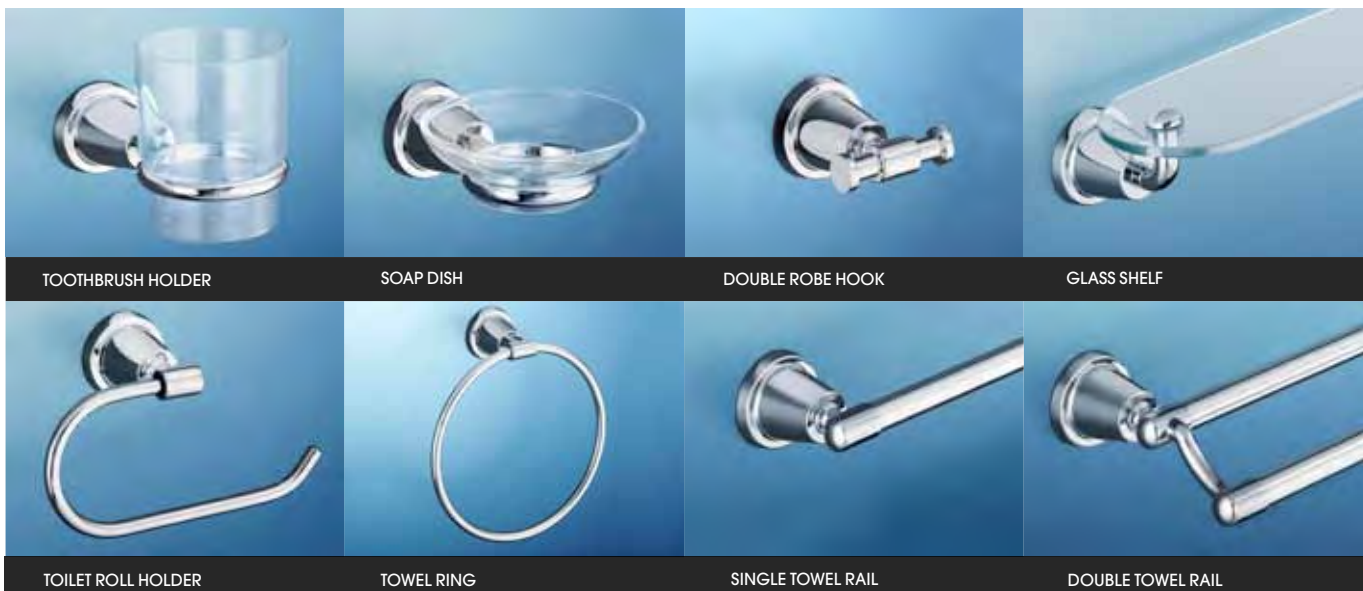

Showers

From luxurious rain showers to height adjustable rail showers, wall showers or hand showers, there is a Caroma shower to suit all your needs

RAIN SHOWERS

- Indulgent rain shower experience
- Sleek, minimalist design
- Indus - Three shower sizes to choose from: 150mm shower - WELS 3 star rated, 200mm and 250mm showers - WELS 2 star rated
- Shower arms sold separately

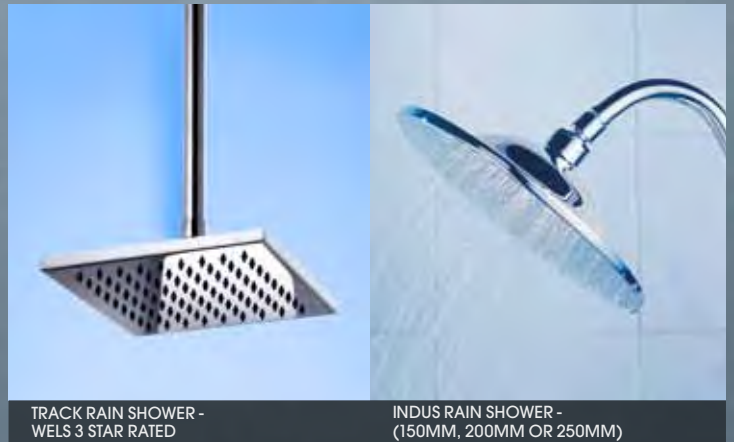

TRACK RAIN SHOWER -
WELS 3 STAR RATED

INDUS RAIN SHOWER -
(150MM, 200MM OR 250MM)

RAIL SHOWERS

- Height adjustable to suit the whole family
- A selection of contemporary designs
- Hand pieces can be removed from the rail for extra functionality and trouble free cleaning
- Easy clean feature helps break up residue ensuring a clean shower head
- Water saving without compromising performance



TRACK SHOWER ON RAIL
- WELS 3 STAR RATED

LIANO SHOWER ON RAIL
- WELS 3 STAR RATED
(FOUR SPRAY PATTERNS)

MYSTIC SHOWER ON RAIL
- WELS 3 STAR RATED
(FIVE SPRAY PATTERNS)

HAND SHOWERS

- Multi function showers with the flexibility of a removable handpiece
- Easy clean feature helps break up residue ensuring a clean shower head
- Select from the bold, contemporary styling of Track, the sleek, minimalist styling of Liano, or the soft, contoured styling of Mystic
- Swivel hoses prevent kinking and coiling
- Water saving without compromising performance
- Allows easy cleaning of your shower recess



TRACK HAND SHOWER
- WELS 3 STAR RATED

LIANO HAND SHOWER
- WELS 3 STAR RATED
(FOUR SPRAY PATTERNS)

MYSTIC HAND SHOWER
- WELS 3 STAR RATED
(FIVE SPRAY PATTERNS)

ADJUSTABLE WALL SHOWERS

- Modern designs with the flexibility to adjust the height and direction of flow
- Lusso features a uniform and consistent spray pattern
- Micara and Starlite offer a choice of five spray patterns, including two combination sprays & patented Stayfast® shower arm locks
- Water saving without compromising performance



LUSSO ADJUSTABLE
WALL SHOWER
- WELS 3 STAR RATED

MICARA / STARLITE
ADJUSTABLE WALL SHOWER
- WELS 3 STAR RATED
(FIVE SPRAY PATTERNS)

SHOWER SYSTEMS

- Adjustable fixed shower outlet complemented by a stylish sleek hand piece
- Overhead shower combined with a separate hand shower allows user flexibility
- Includes bath/shower mixer with diverter to deliver a complete shower system
- Water saving without compromising performance



TRACK SHOWER SYSTEM
- WELS 3 STAR RATED

FIXED WALL SHOWERS

- Easy care designs with adjustable head to control the direction of flow
- Mystic offers a choice of five spray patterns, including two combination sprays
- Lumiere offers a choice of four spray patterns, including one combination spray
- Water saving without compromising performance

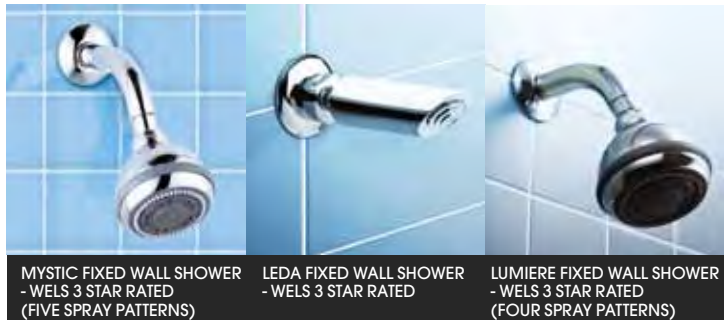

MYSTIC FIXED WALL SHOWER
- WELS 3 STAR RATED
(FIVE SPRAY PATTERNS)

LEDA FIXED WALL SHOWER
- WELS 3 STAR RATED

LUMIERE FIXED WALL SHOWER
- WELS 3 STAR RATED
(FOUR SPRAY PATTERNS)

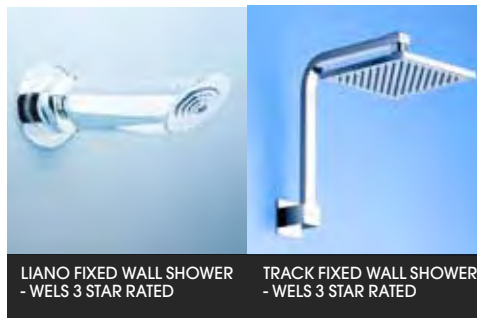

LIANO FIXED WALL SHOWER
- WELS 3 STAR RATED

TRACK FIXED WALL SHOWER
- WELS 3 STAR RATED

SHOWER SPRAY PATTERNS

Liano shower spray patterns

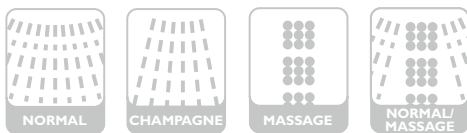

Micara & Starlite shower spray patterns



Mystic shower spray patterns

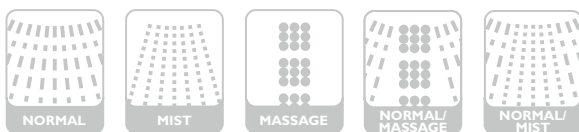

Lumiere shower spray patterns

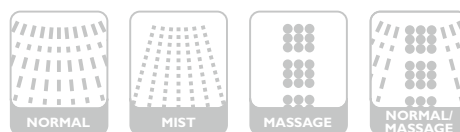

Care TAPS & MIXERS

All Caroma Care taps and mixers feature a ceramic disc cartridge for smooth, easy activation to assist those with weaker hand mobility as well as providing low maintenance, drip free operation. Caroma Care mixers include an extended lever to provide easy reach, whilst Caroma Care taps include lever handles, ensuring a smooth activation

TRIDENT LEVER BASIN SET

- Distinctive design suitable for both traditional and contemporary styled homes
- WELS 5 star rated
- Optional coloured dress rings available
- Bath, wall sink, shower and washing machine* sets are also available

LUSSO LEVER BASIN SET

- Easy and effortless water control
- WELS 5 star rated
- Bath, shower, hob sink and washing machine* sets are also available

NORDIC CARE BASIN MIXER

- Temperature limiting device saves energy
- WELS 5 star rated
- Bath/shower mixer (with or without diverter) and sink mixer (150mm and 240mm[‡]) also available

OPUS CARE BASIN MIXER[‡]

- Long life, soft close cartridge reduces noisy water hammer
- Ergonomic, easy grip handle
- WELS 5 star rated
- Bath/shower mixer (with or without diverter) sink mixer (150mm and 240mm)[‡] also available

ACQUA CARE BASIN MIXER[‡]

- Classic, easy clean design
- WELS 5 star rated
- Bath/shower mixer (with or without diverter) and sink mixer[‡] also available

G SERIES RANGE

- Ideal for hospitals, aged care facilities, schools, and in-house care
- Each set available in one easy order code or components available separately
- Handles available in three sizes 65mm, 115mm, 150mm
- Multiple mix and match combinations available. Refer to Caroma Care Range Brochure or visit www.caroma.com.au for more details



TRIDENT LEVER BASIN SET

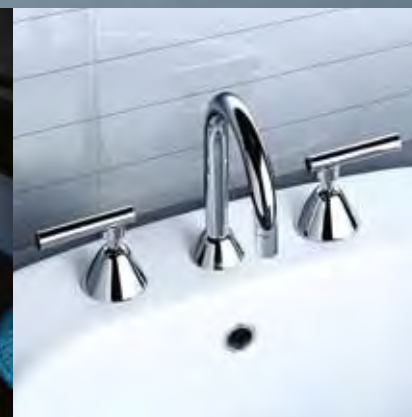

LUSSO LEVER BASIN SET



NORDIC CARE BASIN MIXER

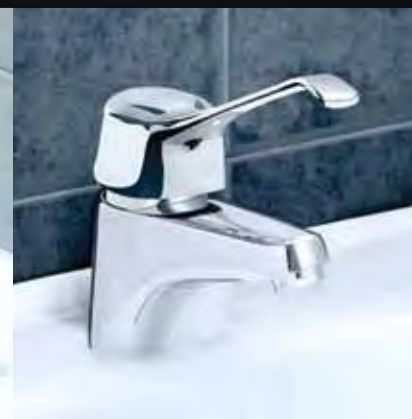

OPUS CARE BASIN MIXER

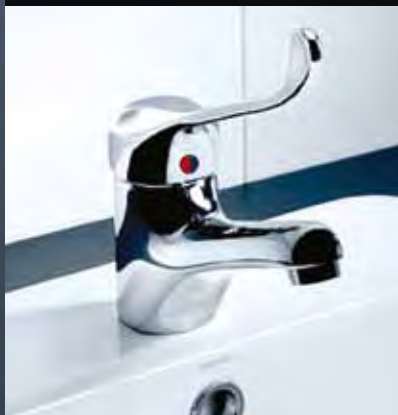

ACQUA CARE BASIN MIXER

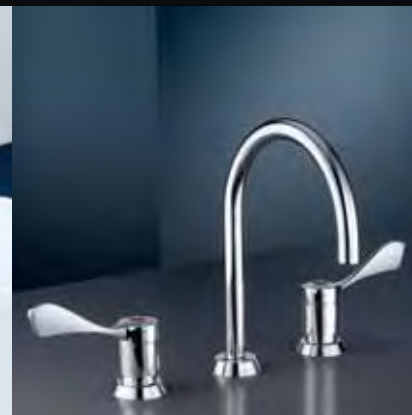

G SERIES CONCEALED LEVER HOB SINK SET

[‡]Care lever handle not included as standard, lever handle sold separately.



Can be installed to comply to AS 1428.1 disability standard required for public buildings.

Technical DETAILS - DIAGRAMS AND SPECIFICATIONS

LIANO TAPS

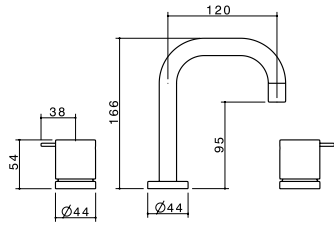

Basin set 96147C5A

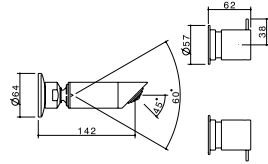

Shower set 96149C3A

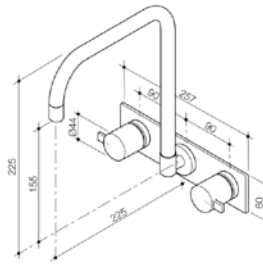

Wall sink set 96189C4A

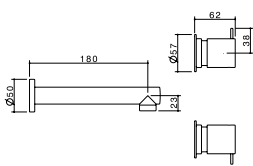

Bath set 96148C

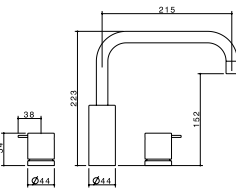

Hob bath/spa set 96162C

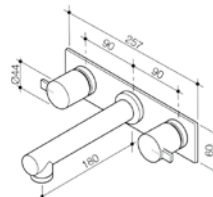

Bath set with platemount 96188C

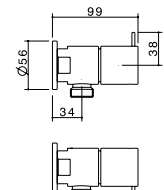

Washing machine set 96172C

STARLITE TAPS

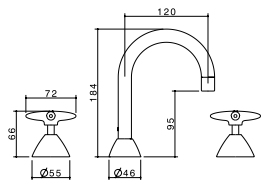

Basin set 91021C5A

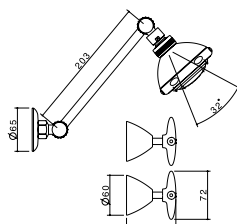

Shower set 91023C3A

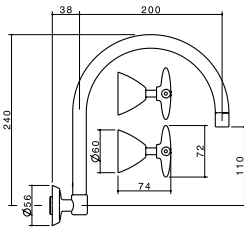

Wall sink set 91024C4A

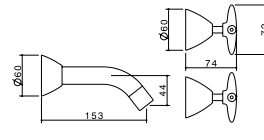

Bath set 91022C

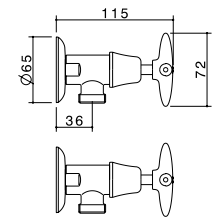

Washing machine set 91027C

TRIDENT LEVER & CROSS TAPS

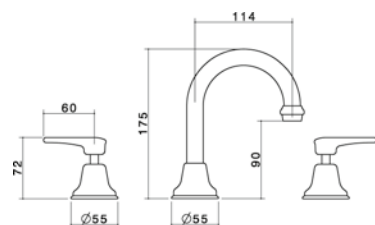

Basin set (lever) 96700C5A

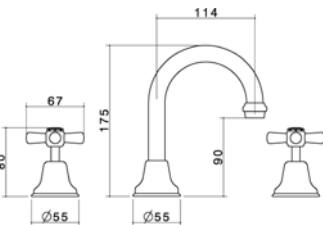

Basin set (cross) 96500C5A

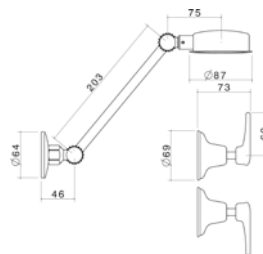

Shower set (lever) 96702C3A

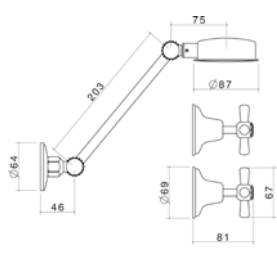

Shower set (cross) 96516C3A

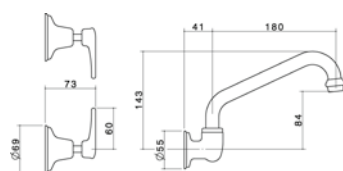

Wall sink set (lever) 96703C4A

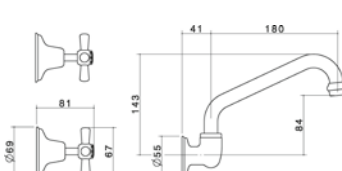

Wall sink set (cross) 96512C4A

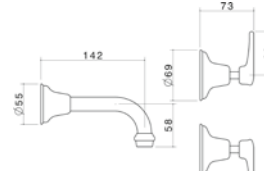

Bath set (lever) 96707C

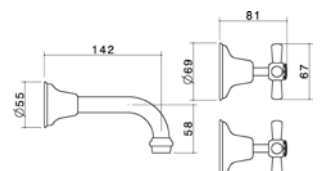

Bath set (cross) 96510C

TRIDENT LEVER & CROSS TAPS

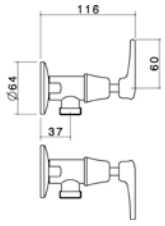

Washing machine set (lever) **96707C**

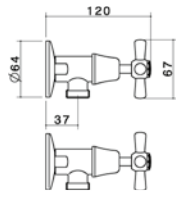

Washing machine set (cross) **96540C**

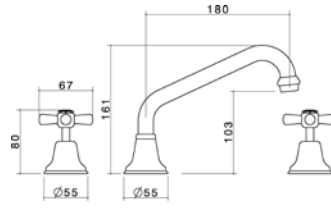

Hob sink set (cross) **96522C4A**

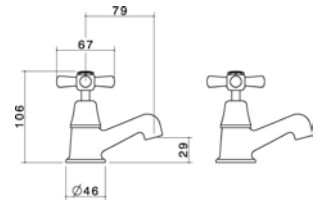

Pillar tap set (cross) **96555C5A**

LUSSO LEVER & CROSS TAPS

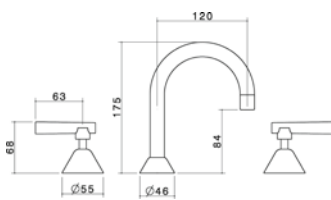

Basin set (lever) **98408C5A**

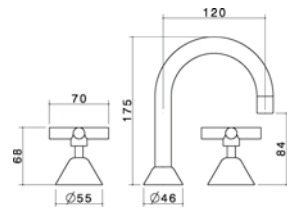

Basin set (cross) **98401C5A**

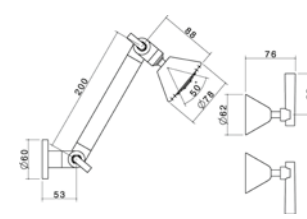

Shower set (lever) **98410C3A**

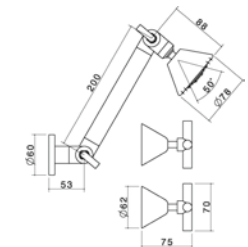

Shower set (cross) **98403C3A**

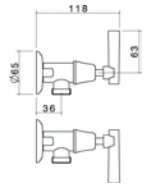

Washing machine set (lever) **98414C**

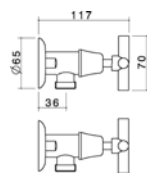

Washing machine set (cross) **98407C**

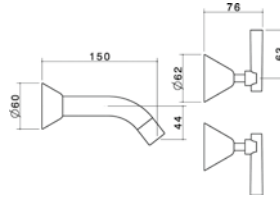

Bath set (lever) **98409C**

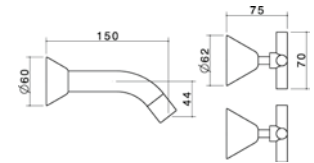

Bath set (cross) **98402C**

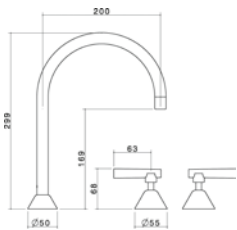

Hob sink set (lever) **98411C4A**

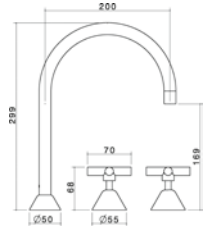

Hob sink set (cross) **98404C4A**

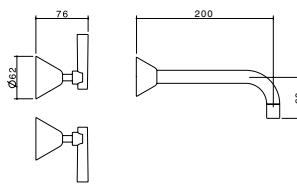

Wall basin set (lever) **98429C5A**

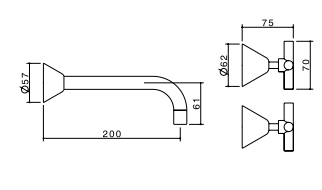

Wall basin set (cross) **98430C5A**

MIDAS TAPS

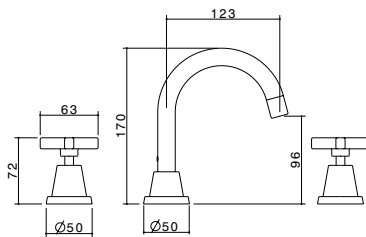

Basin set **94201C5A**

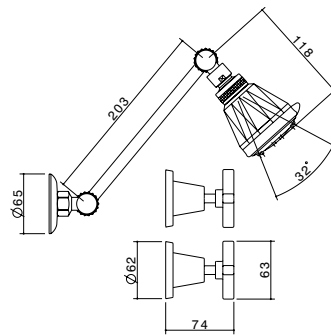

Shower set **94203C3A**

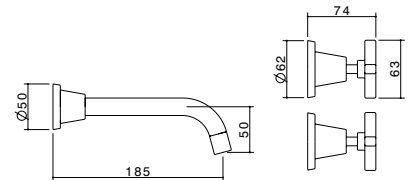

Bath set **94202C**

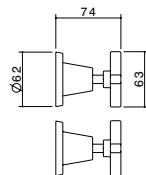

Wall top assembly **94205C**

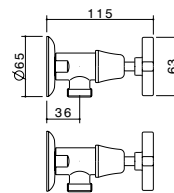

Washing machine set **94206C**

TRACK MIXERS

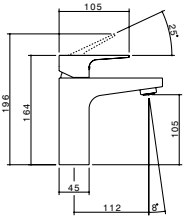

Basin mixer 90201C5A

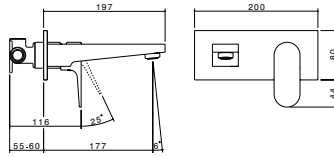

Wall basin mixer 90208C5A

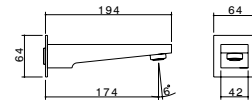

Bath outlet 90205C

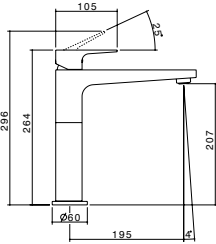

Sink mixer 90202C4A

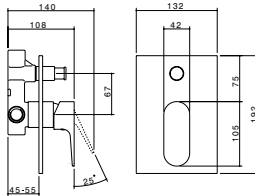

Bath/shower mixer w/diverter 90204C

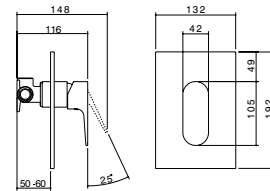

Bath/shower mixer 90203C

LIANO MIXERS

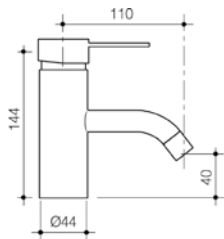

Basin mixer 96142C5A

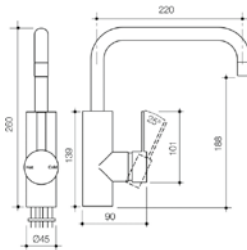

Sink mixer 96135C4A

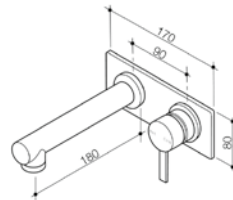

Bath mixer with 180mm straight outlet and platemount 96183C
Also available as a wall basin mixer 96183C5A

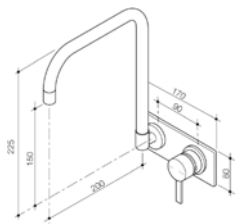

Wall sink mixer 96185C4A

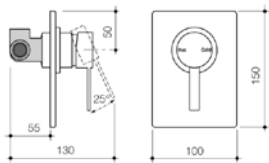

Bath/shower mixer rectangular plate 96145C

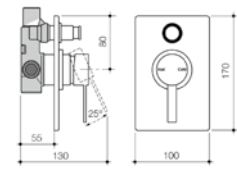

Bath/shower mixer w/diverter 96146C

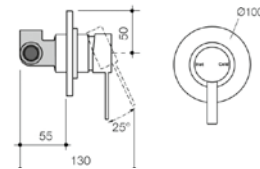

Bath/shower mixer round plate 96163C

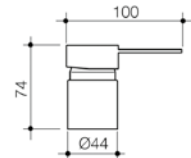

Hob mixer 96192C

NORDIC MIXERS

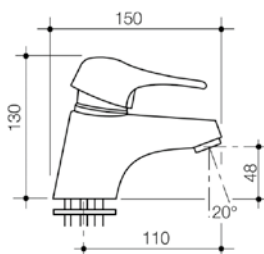

Basin mixer 90947C5A

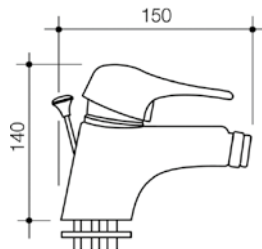

Bidette mixer 90950C

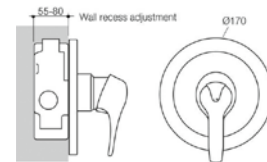

Bath/shower mixer 90948C

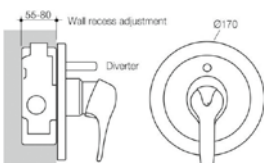

Bath/shower mixer w/diverter 90949C

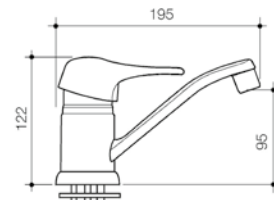

Sink mixer (150mm) 90960C4A

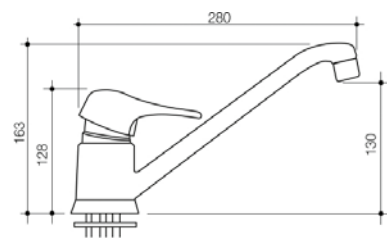

Sink mixer (240mm) 90946C4A

OPUS MIXERS

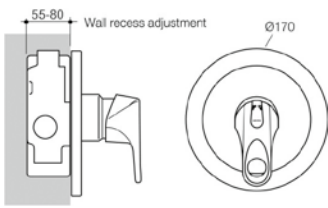

Bath/shower mixer **87143C**

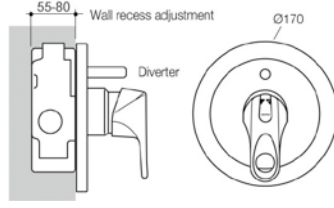

Bath/shower mixer w/diverter **87142C**

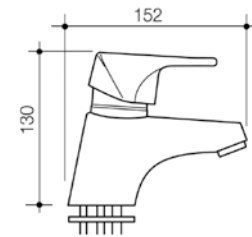

Basin mixer **87144C5A**

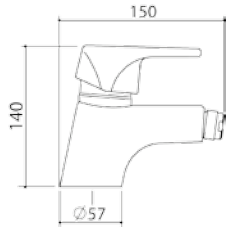

Bidette mixer **87141C**

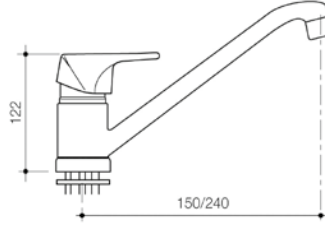

Sink mixer (150mm) **87160C4A**

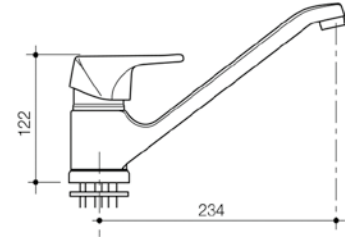

Sink mixer (240mm) **87148C4A**

ACQUA MIXERS

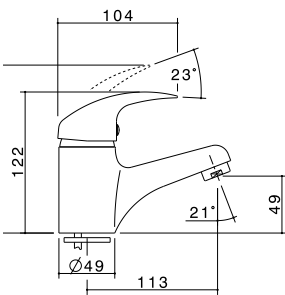

Basin mixer **90987C5A**

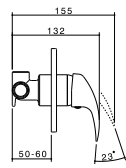

Bath/shower mixer **90988C**

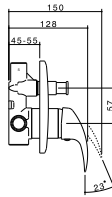
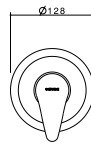

Bath/shower mixer w/diverter **90958C**

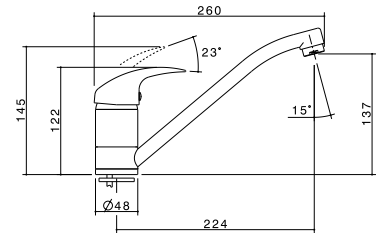

Sink mixer **90986C4A**

TRACK ACCESSORIES

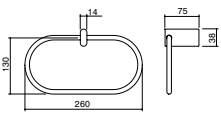

Towel ring **90229C**

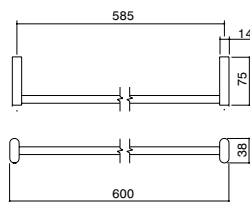

Single towel rail - 600mm **90225C**

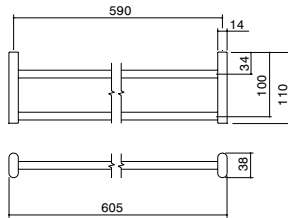

Double towel rail - 600mm **90226C**

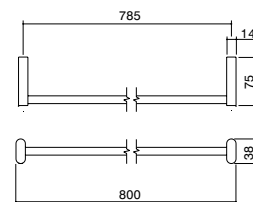

Single towel rail - 800mm **90231C**

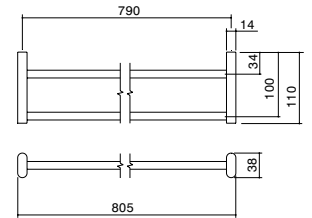

Double towel rail - 800mm **90232C**

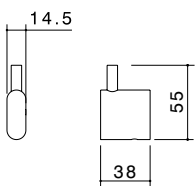

Robe hook **90227C**

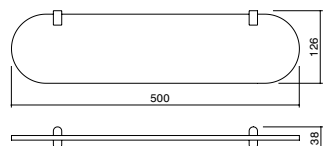

Bathroom shelf **90230C**

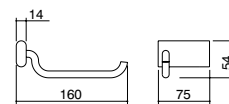

Toilet roll holder **90224C**

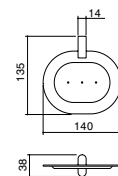

Soap dish **90228C**

LIANO ACCESSORIES

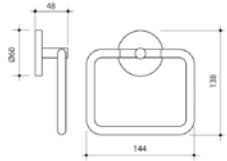

Towel ring 96122C

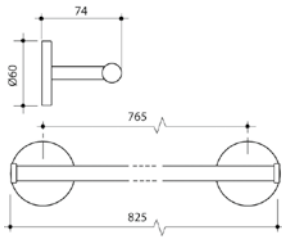

Single towel rail 96120C

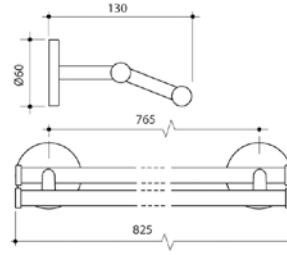

Double towel rail 96121C

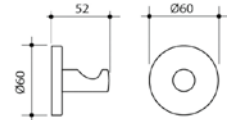

Robe hook 96125C

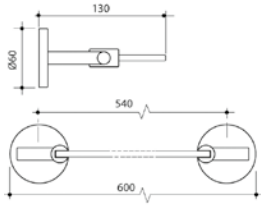

Vanity shelf (glass) 96127C

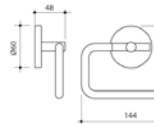

Toilet roll holder 96124C

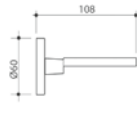

Soap dish 96126C

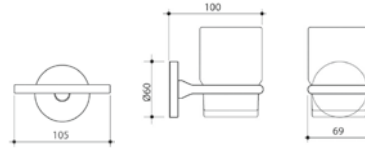

Toothbrush holder & tumbler 96123C

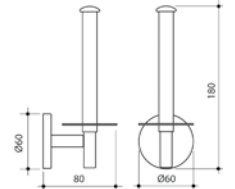

Spare toilet roll holder 96128C

COSMO ACCESSORIES

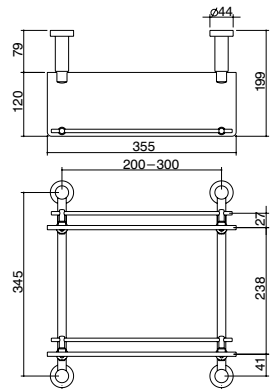

Glass shelf - double 305005C

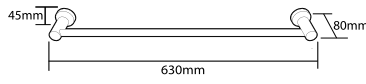

Single towel rail - 600mm 306128C

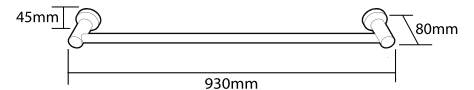

Single towel rail - 900mm 306132C

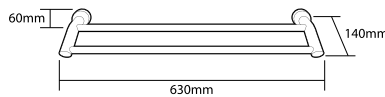

Double towel rail - 600mm 306129C

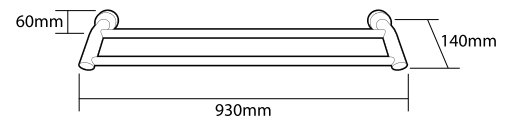

Double towel rail - 900mm 306133C

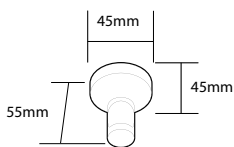

Robe hook 309128C

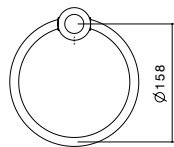

Towel ring 305102C

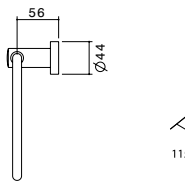

Soap holder 304128C

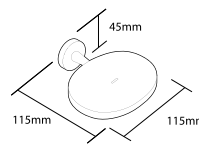

Hand towel rail - 200mm 308128C

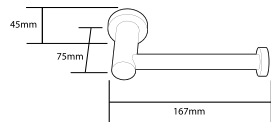
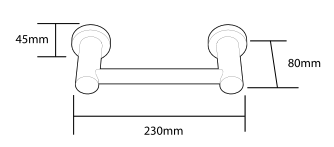

Toilet roll holder 303128C

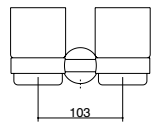

Tumbler holder - double 305101C

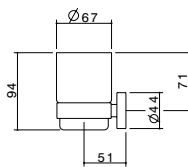

Soap basket 305103C

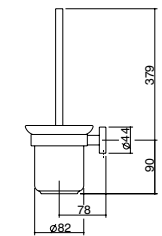
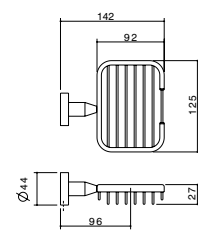

Toilet brush & holder 305001C

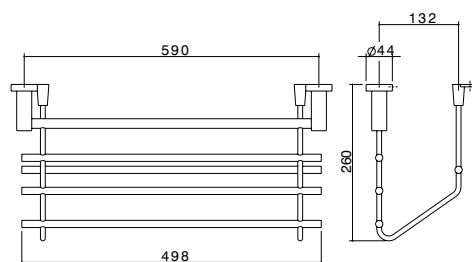

Towel rack 305004C

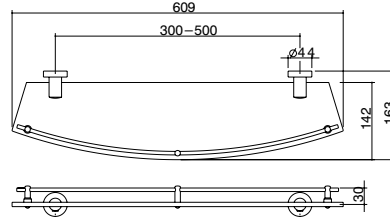

Glass shelf - single 305003C

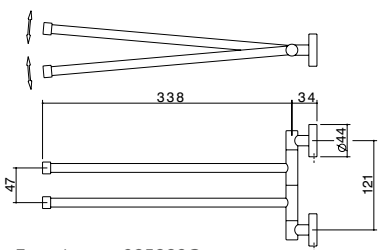

Towel arms 305002C

MIDAS ACCESSORIES

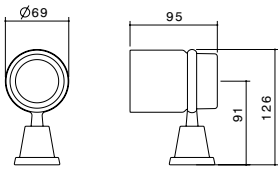

Toothbrush holder
94237C

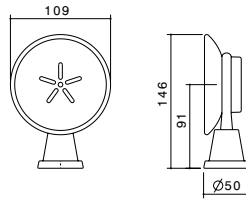

Soap dish
94232C

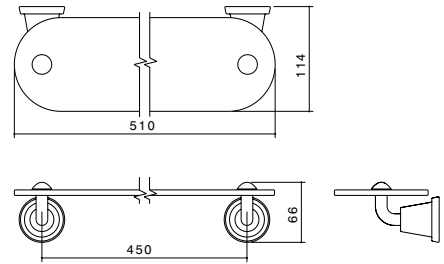

Glass shelf
94236C

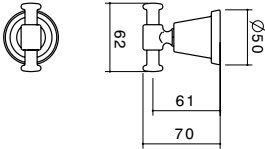

Double robe hook
94231C

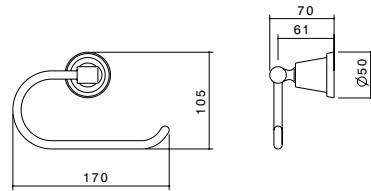

Toilet roll holder
94230C

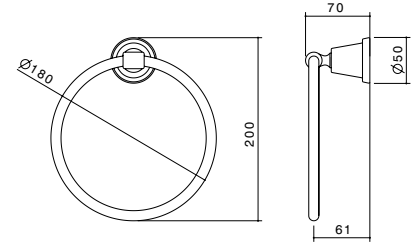

Towel ring
94235C

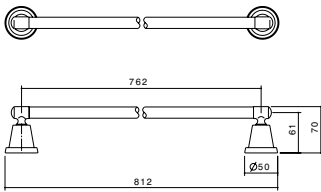

Single towel rail
94233C

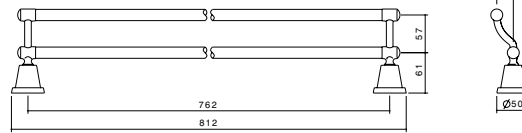

Double towel rail
94234C

RAIN SHOWERS

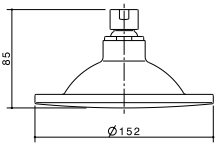

Indus rain shower
150mm 91050C3A

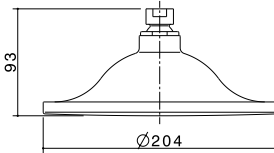

Indus rain shower
200mm 91051C2A

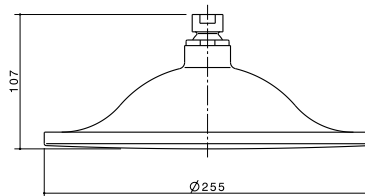

Indus rain shower
250mm 91052C2A

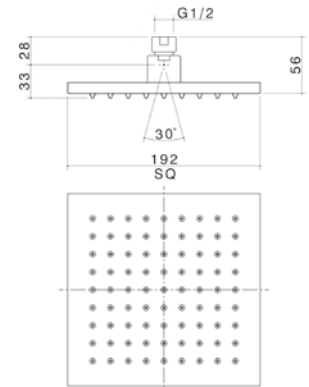

Track rain shower 90214C3A

RAIL SHOWERS

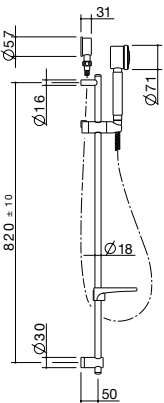

Liano shower on rail
91014C3A

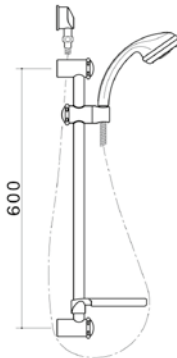

Mystic shower on rail
91013C3A

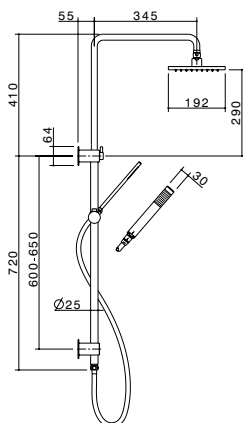

Track rail shower
with overhead
90212C3A

HAND SHOWERS

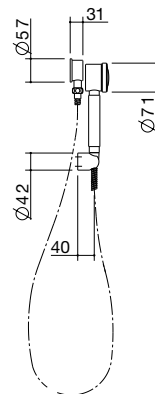

Liano hand shower
91012C3A



Mystic hand shower
91011C3A

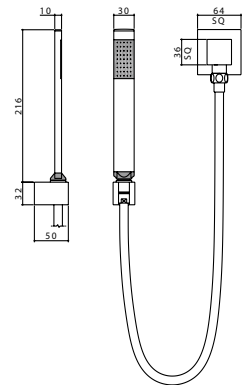

Track hand shower
90213C3A

ADJUSTABLE WALL SHOWERS

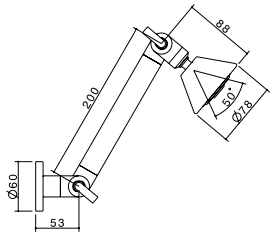

Lusso adjustable wall shower
98400C3A

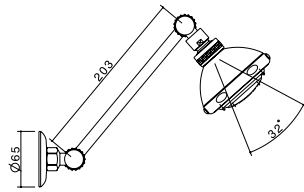

Micara/Starlite adjustable wall shower
91031C3A

SHOWER SYSTEMS

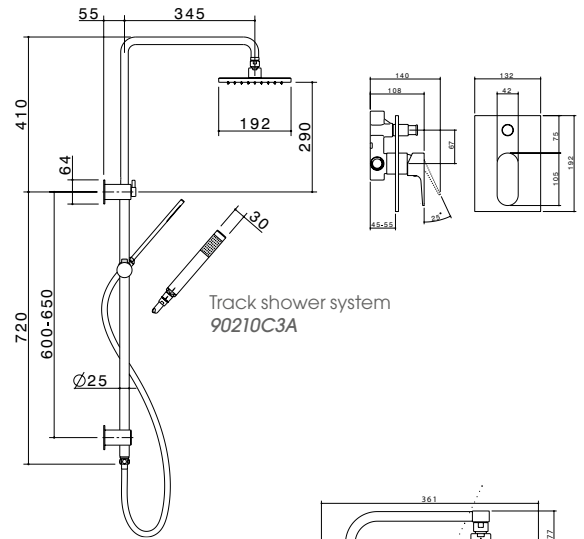

Track shower system
90210C3A

FIXED WALL SHOWERS

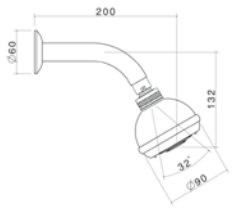

Mystic fixed wall shower
91010C3A

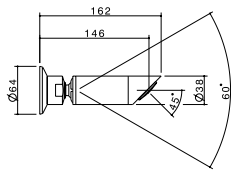

Leda fixed wall shower
97323C3A

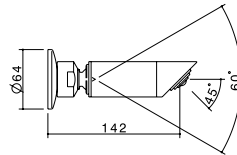

Liano fixed wall shower
97017C3A

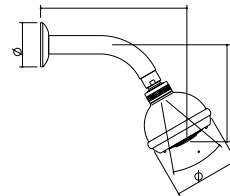

Lumiere fixed wall shower
90125C3A

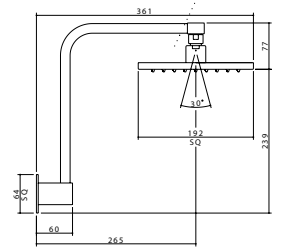

Track fixed shower outlet
90211C3A

CARE TAPS & MIXERS

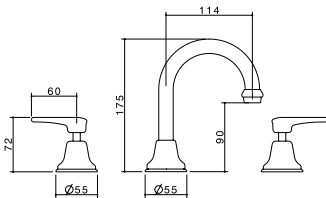

Trident lever basin set
96700C5A

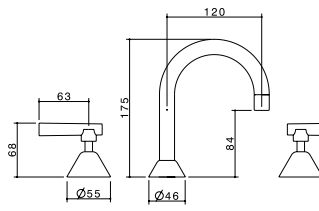

Lusso lever basin set
980408C5A

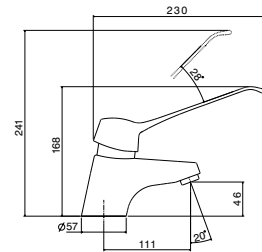

Nordic care basin mixer
90965C5A

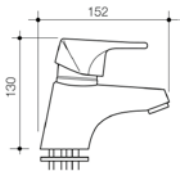

Opus basin mixer
87144C5A

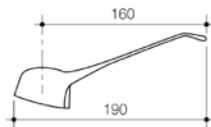

Opus care lever handle
90921C

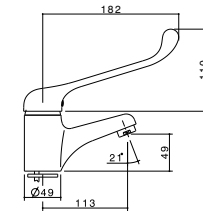

Acqua basin mixer
90987C5A

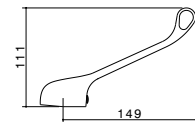

Acqua care lever handle
90997C

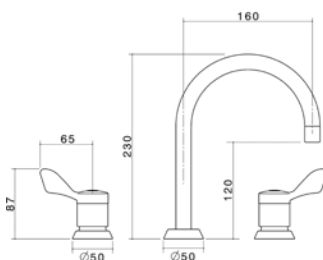

G series concealed lever hob
sink set 160mm outlet, 65mm levers
G71420CA

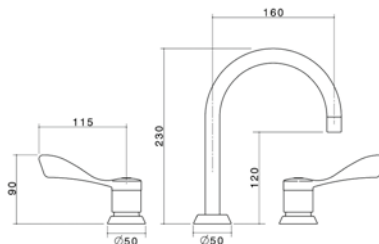

G series concealed lever hob
sink set 160mm outlet, 115mm levers
G71430CA

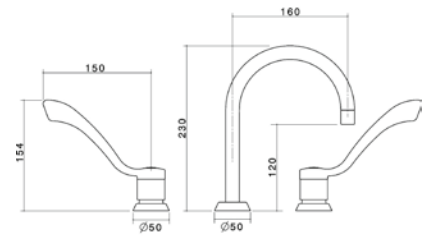

G series concealed lever hob
sink set 160mm outlet, 150mm levers
G71440CA

caroma | design for *life*

Caroma Industries Limited
Phone 13 14 16
www.caroma.com.au

© Copyright 2010. Caroma Industries Ltd. ABN 35 000 189 499. All rights reserved. Material and design specifications subject to change without notice. Product colour reproduction is as near to actual product colour as production methods allow. Warning: Products in this brochure are the subject of registered designs and patents. ® is a registered trademark of Caroma Industries. This brochure relates to Australian products only and some product, design or specifications may differ in other countries.