

HÄFELE



www.hafele.com.au

THE ESSENTIAL LOOX 2017 LED LIGHTING SOLUTIONS

Engineered by Häfele

A DIALOGUE ABOUT AMBIANCE.

LED light in furniture and furnishings.
An effective extension of lighting the room.

LIGHTS

Light is a fundamental part of life. One, that affects our well-being noticeably. The bright, cool white morning light is very different from the warm glow of candles or light bulbs. Inside, one tries to mimic daylight in an effort to design the room with it. Light in furniture and furnishings blends harmoniously with the lighting of the room adding another layer to the design – a fourth dimension. This way, subtle nuances in the ambiance are created and specific areas are separated or accentuated to create a perfectly composed holistic effect.

Due to the low heat development, the small fixture size and the long service life LED lights are ideally suited for this purpose. Light colours, even differently tempered whites, are recreated realistically. With the Loox LED system work areas, presentation areas and living rooms can be illuminated for functional and decorative purposes. Well-being can be influenced in a targeted manner. And it is surprisingly simple.

LOOX - Engineered by Häfele

- > A system that simplifies design
- > The comprehensive kit of light and functions
- > Easy and quick installation: Plug and Play
- > Consistently high quality with certified Häfele worldwide standards

DRIVER

SWITCH

MAINS PLUG

CONTENTS

LOOX LED 2020, 12V

RECESS/SURFACE MOUNTED
DOWNLIGHT



> page 4

LOOX LED 2043, 12V

LED FLEXIBLE STRIPLIGHT,
5 M, 300 LEDS



> page 5

LOOX LED 2045, 12V

LED FLEXIBLE STRIPLIGHT,
5 M, 450 LEDS



> page 6

LOOX LED 2016, 12V

LED FLEXIBLE STRIPLIGHT,
5 M, 150 RGB LEDS



> page 7

LOOX 12 V DRIVERS

AND ACCESORIES

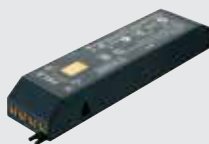

> page 8

LOOX LED 3001, 24V

RECESS MOUNTED WITH SURFACE
MOUNTED OPTION



> page 9

LOOX LED 3015, 24V

FLEXIBLE LED STRIPLIGHT,
5 M, 600 LEDS



> page 10

LOOX 24-V DRIVERS

AND ACCESORIES



> page 11

LOOX PROFILES

FOR FLEXIBLE STRIPLIGHTS

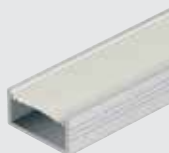

> page 12

LOOX SWITCHES



> page 13

LOOX MULTIMEDIA

SOUNDSYSTEM 105 AND
LOOX USB CHARGING STATION



> page 14

Light – Engineered by Häfele

Häfele combines the knowledge of the essence of light and its high product development competence with the on-going analysis of international markets. On this basis, the high-quality Loox LED system was developed to effectively combine the needs of both users and installers.

ENGINEERED
BY HÄFELE

LOOX 2020 - DOWNLIGHT

RECESS OR SURFACE MOUNTED DOWNLIGHT, ROUND

SUITABLE FOR WET AREAS

Dimmable



12 V SYSTEM





The LOOX 2020 generates uniform, even distributed light and is ideal for atmospheric lighting in all areas.

The light can be used in a variety of ways because of the two installation types and three colour temperatures.

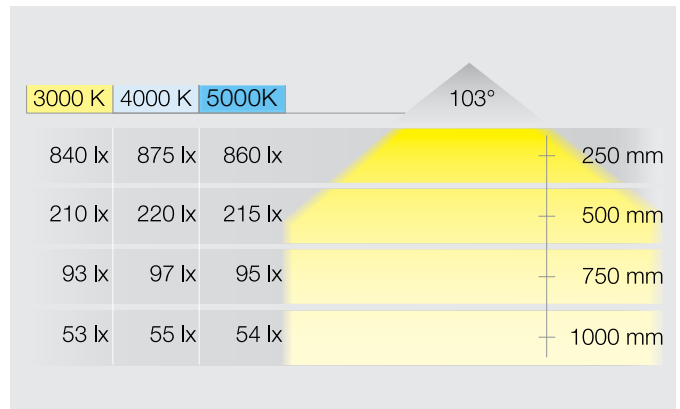
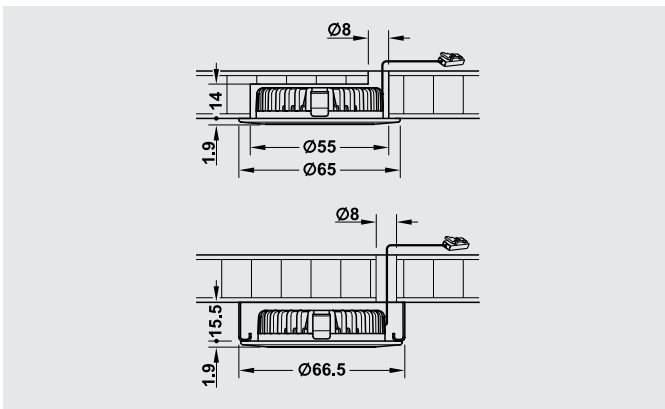
Note:
 Only IP 44 rated when recess mounted (provides protection against moisture).



	Description	Finish	Wattage (W)	Light Colour (K)	Cat. No.
	LOOX 2020 Downlight (6 LED's)	Nickel plated, matt	2.7	3000	833.72.280
				4000	833.72.283
				5000	833.72.286
	Surface mount ring	Nickel plated, matt	-	-	833.72.800

Packing: 1 piece (supplied with 2 mtr connecting lead)

Note:
 Please order 12 V LOOX driver and switch separately. See pages 8 and 13.

LOOX 2043 - STRIPLIGHT

LED FLEXIBLE STRIPLIGHT, 5 M, 300 LEDs

Dimmable



The LOOX 2043 5 m striplight with its 300 LEDs has a wide range of decorative application options. It can be shortened every 50 mm.

The areas of application are manifold due to the corner and clip connectors.

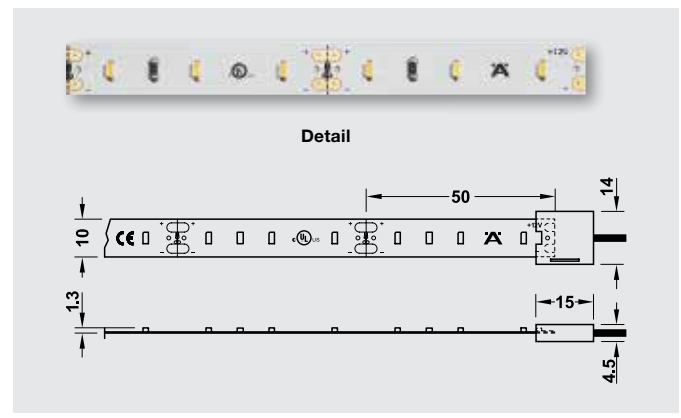
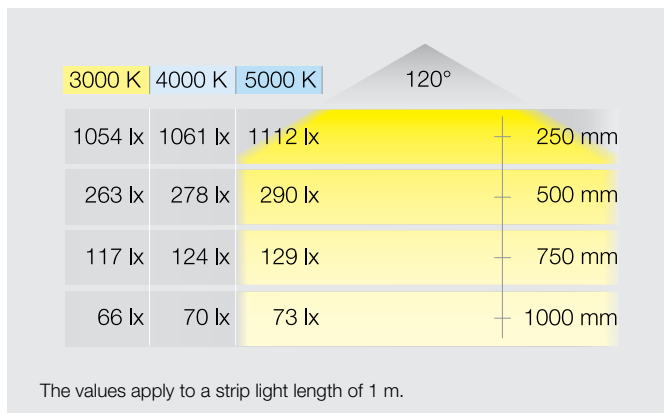

	Description	Wattage (W)	Length (mm)	Light Colour (K)	Cat. No.
	LOOX 2043 Striplight (300 LED's)	24 (4.8W p/m)	5000	3000	833.73.121
				4000	833.73.122
				5000	833.73.123

Packing: 1 piece (supplied with 2 mtr connecting lead)

	Description	Length (mm)	Cat. No.
	LOOX 2043 Connection lead	2000	833.73.728
	LOOX 2043 Interconnecting lead	50	833.73.721
		500	833.73.719
		1000	833.73.722
		2000	833.73.720
	LOOX 2043 Clip connector	-	833.73.731
	LOOX 2043 Corner connector (rigid)	-	833.73.733

Packing: 1 piece



Note:

Please order 12 V LOOX driver and switch separately. See pages 8 and 13.

LOOX 2045 - STRIPLIGHT

LED FLEXIBLE STRIPLIGHT, 5 M, 450 LEDS

Dimmable



12 V SYSTEM



The LOOX 2045 striplight can be used universally. It can be shortened every 33 mm and can therefore be processed in a flexible way.

In combination with our aluminium profiles (see page 12), different diffusers and installation types are available. You can give your lighting effects an individual touch using the corner and clip connectors.

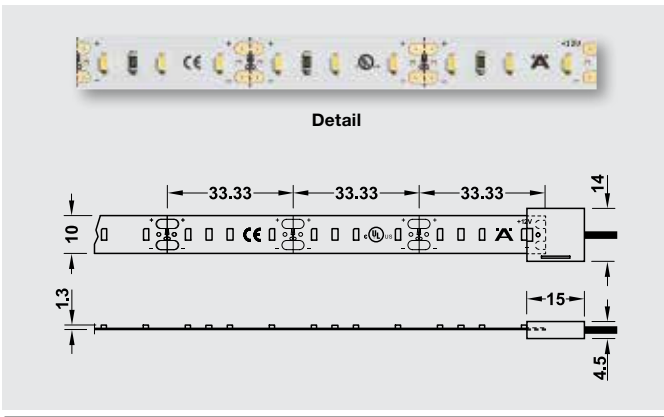

3000 K	4000 K	5000 K	120°	
1703 lx	1714 lx	1725 lx		250 mm
425 lx	429 lx	431 lx		500 mm
189 lx	190 lx	192 lx		750 mm
106 lx	107 lx	108 lx		1000 mm

The values apply to a strip light length of 1 m.

	Description	Wattage (W)	Length (mm)	Light Colour (K)	Cat. No.
	LOOX 2045 Striplight (450 LED's)	36 (7.2 W p/m)	5000	3000	833.73.131
				4000	833.73.132
				5000	833.73.133

Packing: 1 piece (supplied with 2 mtr connecting lead)

	Description	Length (mm)	Cat. No.
	LOOX 2045 Connection lead	2000	833.73.728
	LOOX 2045 Interconnecting lead	50	833.73.721
		500	833.73.719
		1000	833.73.722
		2000	833.73.720
	LOOX 2045 Clip connector	-	833.73.731
	LOOX 2045 Corner connector (rigid)	-	833.73.733

Packing: 1 piece



Note:

Please order 12 V LOOX driver and switch separately. See pages 8 and 13.

LOOX LED 2016 - STRIPLIGHT

LED FLEXIBLE STRIPLIGHT, 5 M, 150 RGB LEDS

Dimmable



RGB

Bright light sources with changing colours are often in demand for lighting.

The LED 2016 colour changing strip light easily meets these requirements.

Dimmable via RGB colour mixer with remote control, with a max. 10 colour mixers controlled with 1 remote control



12 V SYSTEM

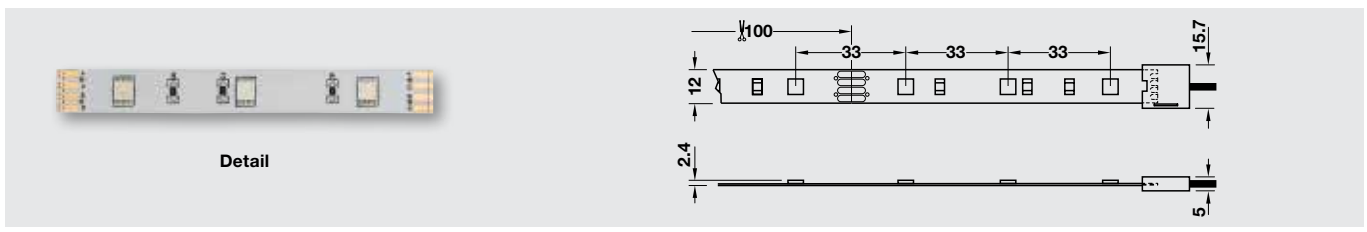

	Description	Colour	Wattage (W)	Length (mm)	Cat. No.
	LOOX 2016 Striplight (150 LED's)	RGB	36 (7.1 W p/m)	5000	833.73.450

Packing: 1 piece (supplied with 2 mtr connecting lead)

	Description	Length (mm)	Cat. No.
	LOOX 2016 Connection lead	2000	833.74.764
		4000	833.74.745
	LOOX 2016 Interconnecting lead	50	833.74.766
		500	833.74.767
		2000	833.74.768
	LOOX 2016 Clip connector for LOOX Striplight	-	833.74.761
	LOOX 2016 Corner connector (rigid)	-	833.74.760
	LOOX 2016 9-way RGB distributor with 1m lead	1000	833.74.741
	LOOX 2016 RGB Colour mixer, with 4-way distributor, max. 30 W, (power consumption 0.6 W)	-	833.74.802
	LOOX 2016 Remote control for RGB colour mixer	-	833.74.708

Packing: 1 piece





Note:

Please order 12 V LOOX driver and switch separately. See pages 8 and 13.





LOOX 12V DRIVERS AND ACCESSORIES

The driver is the heart of the LOOX system, and is suitable for connecting to all of the most popular power systems that are used around the world.

The LOOX Driver has an integrated switching function and connections for the most popular types of switch.

	Description	Slots	Wattage (W)	Dimensions (mm)	Cat. No.
	LOOX 12V Driver	6 x Lights, 1 x Switch & 1 x Primary Lead	0-15	140 x 43 x 20 (L x W x H)	833.74.905
			0-30	195 x 43 x 28 (L x W x H)	833.74.906
			0-60	208 x 56.5 x 30 (L x W x H)	833.74.939

Packing: 1 piece (supplied with 2mtr primary lead)

	Description	Dimensions (mm)	Cat. No.
	LOOX 12V Extension lead	500	833.74.724
		1000	833.74.725
		2000	833.74.726
	LOOX 12V 4-way extension lead	6500	833.74.765
	LOOX 12V 6-way distributor	58.5 x 38.2 x 10.2 (L x W x H)	833.74.743
	LOOX 12V 3-way distributor with switching function	57 x 34 x 18 (L x W x H)	833.74.742
	LOOX 12V Multi-switch box	50 x 40 x 19 (L x W x H)	833.89.064

Packing: 1 piece



Note:

Maximum lead length from driver to switch = 6 mtr.
Please order switch separately. See pages 13.

LOOX 3001 - DOWNLIGHT

RECESS OR SURFACE MOUNTED DOWNLIGHT, ROUND

Dimmable



The powerful LOOX 3001 with a prismatic cover provides variable design options with two light colours and two installation types.

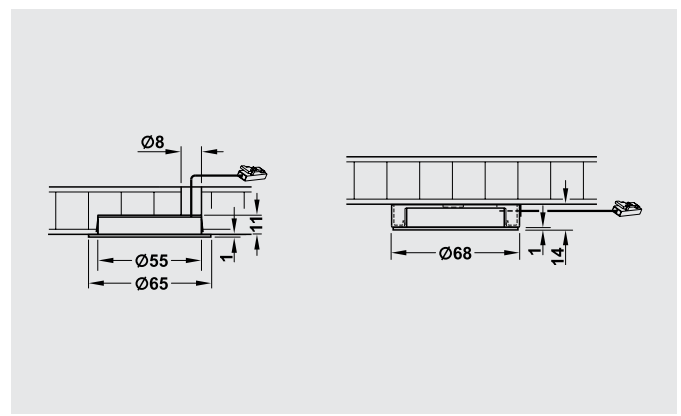
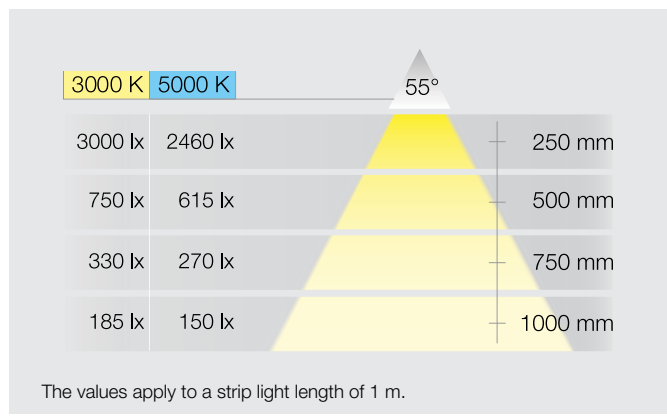

	Description	Light Colour (K)	Wattage (W)	Finish	Cat. No.
	LOOX 3001 Downlight (24 LEDs)	3000	1.7	Silver coloured, anodised aluminium	833.75.016
		5000		Aluminium, silver coloured anodised	833.75.006
	Surface mount ring	-	-	Silver coloured	833.77.710

Packing: 1 piece (supplied with 2.5 mtr connecting lead)



Note:

Please order 24 V driver and switch seperately. See pages 11 and 13.

LOOX 3015 - STRIPLIGHT

FLEXIBLE STRIPLIGHT, 5 MTR, 600 LEDS

Dimmable



24V SYSTEM

The 600 LEDs of the LOOX 3015 flexible striplight generate an extremely homogenous and continuous lighting effect.

The extremely powerful LOOX 3015 flexible striplight is available in three light colours, giving your lighting scenarios an individual touch.

When used with the aluminium profiles with milky covers (see page 12), no LED dots are visible.

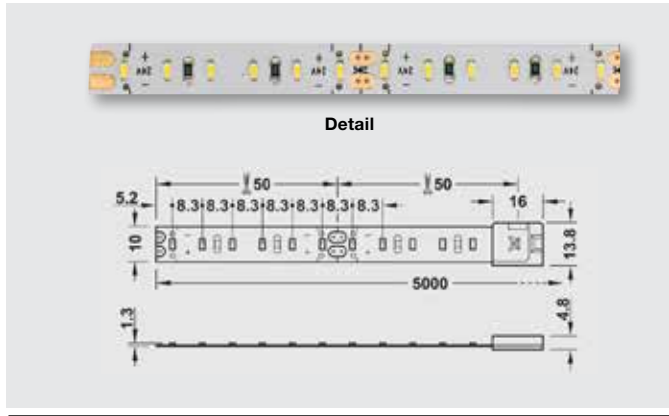

3000 K	4000 K	6000 K	120°
2960 lx	2926 lx	3000 lx	250 mm
732 lx	732 lx	750 lx	500 mm
325 lx	325 lx	330 lx	750 mm
183 lx	183 lx	190 lx	1000 mm

The values apply to a strip light length of 1 m.

	Description	Wattage (W)	Length (mm)	Light Colour (K)	Cat. No.
	LOOX 3015 Striplight (600 LED's)	75 (15 W p/m)	5000	3000	833.76.080
				4000	833.76.081
				6000	833.76.082

Packing: 1 piece (supplied with 2 mtr connecting lead)

	Description	Length (mm)	Cat. No.
	LOOX 3015 Connection lead	2000	833.77.750
	LOOX 3015 Interconnecting lead	50	833.77.740
		500	833.77.741
		2000	833.77.742
	LOOX 3015 Clip connector	-	833.77.760
	LOOX 3015 Corner connector (rigid)	-	833.77.762



Packing: 1 piece

Note: Please order 24 V driver and switch separately. See pages 11 and 13.





LOOX 24V DRIVERS AND ACCESSORIES

The driver is the heart of the LOOX system, and is suitable for connecting to all of the world's most frequently used power systems. It has an integrated switching function and connections for all of the most popular types of switch.

The LOOX Driver has an integrated switching function and connections for the most popular types of switch.

	Description	Slots	Wattage (W)	Dimensions (mm)	Cat. No.
	LOOX 24V Driver	6 x lights, 1 x Switch & 1 x Primary Lead	0-15	140 x 43 x 20 (L x W x H)	833.77.904
			0-30	195 x 43 x 28 (L x W x H)	833.77.905
			0-75	208 x 56.5 x 30 (L x W x H)	833.77.924

Packing: 1 piece (supplied with 2 mtr primary lead)

	Description	Dimensions (mm)	Cat. No.
	LOOX 24V extension lead	500	833.77.706
		1000	833.77.707
		2000	833.77.708
	LOOX 24V 4-way extension lead	6500	833.77.800
	LOOX 24V 6-way distributor	58.5 x 38.2 x 10.2 (L x W x H)	833.77.722
	LOOX 24V 3-way distributor with switching function	57 x 34 x 18 (L x W x H)	833.77.720
	LOOX 24V multi-switch box	50 x 40 x 19 (L x W x H)	833.89.064

Packing: 1 piece

Note:

Lead length from driver to switch max. 6 mtr
Please order switch separately. See pages 13.

LOOX PROFILES

FOR FLEXIBLE STRIPLIGHTS

Profile cover finishes – different light effects



Milky



Frosted

Milky cover:

The material is dyed. Creates a homogenous surface-directed light with uniform intensity. The light appears “soft”.

Frosted cover:

The surface is frosted. The light appears “velvet-white” and creates a sophisticated, high-quality impression.



Note:

Only LOOX 3015 striplights produce no visible LED dots when used with LOOX profiles with milky covers.

	Description	Finish	Dimensions (mm)	Cover	Cat. No.
	Profile for surface mounting	Aluminium, silver coloured anodised	2500 x 18 x 9.5 (L x W x H)	Frosted	833.72.843
				Milky	833.72.840
	End cap	Plastic, silver coloured	–	–	833.72.852
	Profile for surface or recess mounting	Aluminium, silver coloured anodised	2500 x 18 x 14 (L x W x H)	Milky	833.72.841
				Frosted	833.72.842
	End cap	Plastic, silver coloured	–	–	833.72.853
	Profile for corner mounting	Aluminium, silver coloured anodised	2500 x 28 x 20 (L x W x H)	Milky	833.74.812
	End cap with cable outlet	Plastic, silver coloured	–	–	833.74.822
	Bracket	Plastic, silver coloured	–	–	833.74.825
	Mounting plate	Stainless steel, silver coloured	–	–	833.74.826
	Profile for recess mounting	Aluminium, silver coloured anodised	2500 x 18 x 13 (L x W x H)	Milky	833.72.846
				Frosted	833.72.847
	End cap with cable outlet	Plastic, silver coloured	–	–	833.72.854

Packing (profile): 1 piece

Packing (end caps/accessories): 1 pair



Note:

Additional technical information can be found in the 2016 LOOX Lighting System Catalogue.

LOOX SWITCHES

FOR LOOX LED LIGHTS

- > Drill hole Ø (mm): 12/13
- > Sensor range (mm): 0 - 80
- > Finish: Plastic, silver coloured or black (as depicted below)

	Description	Drill Hole (mm)	Dimensions (mm)	Supplied with	Cat. No.
	Sensor switch (modular) – touch-free on/off switching	12	L: 47.3	1 switch	833.89.095
	Door sensor switch (modular)	12	L: 47.3	1 switch	833.89.094
	Motion detector (modular) – automatic on/off switching	12	L: 57.3	1 motion detector	833.89.093
	Dimmer (modular)	12	L: 47.3	1 dimmer	833.89.096
	Surface mount housing for switch	–	48 x 45 x 17 (L x W x H)	1 housing	833.89.090
	Capacitive switch/dimmer (modular) for concealed installation (max. panel depth = 30 mm)	–	Ø: 35 H: 9	1 switch	833.89.087
	Universal door contact switch (modular)	–	51.8 x 40 x 14.2 (L x W x H)	1 switch	833.89.065
	Door contact switch	13	L: 28	1 switch with 2 m lead	833.89.045
		–	57 x 50 x 20 (L x W x H)	1 housing for switch Ø 13 mm	833.89.048
	Lead for modular switch Note: Please order lead for modular switches separately (to connect to LOOX driver).	–	500	1 lead	833.89.054
		–	1000	1 lead	833.89.055
		–	2000	1 lead	833.89.056

LOOX MULTIMEDIA

SOUND SYSTEM 105 / USB CHARGING STATION

NEW TO LOOX!

Sound System 105, with Integrated 5W Exciter – for LOOX 12 V system



- > Area of application: Concealed installation in the kitchen, bathroom or furniture
- > Nominal voltage: 12 V
- > Power consumption: Operation: 7 W
- > Wattage: Amplifier power 5 W
- > Dimensions (mm): 66 x 25 x 140 (W x H x L)
- > Material: Plastic
- > Finish/colour: Black
- > Installation: For screw fixing

! **Note:**

- > Range approx. 10 mtr
- > Please order 12V LOOX driver separately

+ **Supplied with:**

1 Bluetooth® receiver with 2 mtr lead

	Cat. No.
	822.65.001

Packing: 1 piece

LOOX USB Charging Station – for LOOX 12 V system

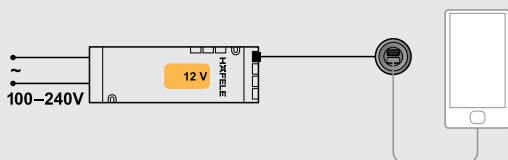
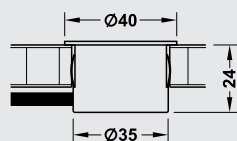

The USB Charging Station is intended for direct installation in the furniture. It can charge up to two tablets or smartphones simultaneously, and therefore provides additional functionality in the living area and stores. The cover ring can be removed, if required.

Cat. No.	833.74.876	833.74.892
Finish	Black	White
Installation	For mounting in drilled hole, with clip fastener	
Output voltage	5 V	
Output current	2 A	
Power consumption	Max. 15 W	
Supplied with	1 USB charging station	

+ **Connection Lead**

- > 500 mm Cat. No. 833.72.128
- > 1000 mm Cat. No. 833.72.129
- > 2000 mm Cat. No. 833.72.123

! **Note:**

Please order connection lead separately for connecting with LOOX 12 V Driver.

NUMERICAL INDEX

LOOX ESSENTIALS

822.65.001.....	14	833.74.708.....	7	833.77.740.....	10
833.72.123.....	14	833.74.724.....	8	833.77.741.....	10
833.72.128.....	14	833.74.725.....	8	833.77.742.....	10
833.72.129.....	14	833.74.726.....	8	833.77.750.....	10
833.72.280.....	4	833.74.741.....	7	833.77.760.....	10
833.72.283.....	4	833.74.742.....	8	833.77.762.....	10
833.72.286.....	4	833.74.743.....	8	833.77.800.....	11
833.72.800.....	4	833.74.745.....	7	833.77.904.....	11
833.72.841.....	12	833.74.760.....	7	833.77.905.....	11
833.72.842.....	12	833.74.761.....	7	833.77.924.....	11
833.72.843.....	12	833.74.764.....	7	833.89.045.....	13
833.72.846.....	12	833.74.765.....	8	833.89.048.....	13
833.72.847.....	12	833.74.766.....	7	833.89.054.....	13
833.72.852.....	12	833.74.767.....	7	833.89.055.....	13
833.72.853.....	12	833.74.768.....	7	833.89.056.....	13
833.72.854.....	12	833.74.802.....	7	833.89.064.....	8
833.73.121.....	5	833.74.812.....	12	833.89.064.....	11
833.73.122.....	5	833.74.822.....	12	833.89.065.....	13
833.73.123.....	5	833.74.825.....	12	833.89.087.....	13
833.73.131.....	6	833.74.826.....	12	833.89.090.....	13
833.73.132.....	6	833.74.840.....	12	833.89.093.....	13
833.73.133.....	6	833.74.876.....	14	833.89.094.....	13
833.73.450.....	7	833.74.892.....	14	833.89.095.....	13
833.73.719.....	5	833.74.905.....	8	833.89.096.....	13
833.73.719.....	6	833.74.906.....	8		
833.73.720.....	5	833.74.939.....	8		
833.73.720.....	6	833.75.006.....	9		
833.73.721.....	5	833.75.016.....	9		
833.73.721.....	6	833.76.080.....	10		
833.73.722.....	5	833.76.081.....	10		
833.73.722.....	6	833.76.082.....	10		
833.73.728.....	5	833.77.706.....	11		
833.73.728.....	6	833.77.707.....	11		
833.73.731.....	5	833.77.708.....	11		
833.73.731.....	6	833.77.710.....	9		
833.73.733.....	5	833.77.720.....	11		
833.73.733.....	6	833.77.722.....	11		

HÄFELE

732.04.639 THE ESSENTIAL LOOX- LED LIGHTING SOLUTIONS - 01.2017

Häfele Australia Pty. Ltd. | 8 Monterey Road | Dandenong | Victoria 3175

Phone: 1300 659 728 | **Fax:** (03) 9212 2001 | **Email:** info@hafele.com.au | www.hafele.com.au

Häfele New Zealand Ltd. | 16 Accent Drive | East Tamaki | Auckland 2013

Phone: 0800 442 335 | **Email:** info@hafele.co.nz | www.hafele.co.nz

HÄFELE LOCATIONS:

Australia | MELBOURNE | SYDNEY | NEWCASTLE | BRISBANE | ADELAIDE | LAUNCESTON | HOBART | PERTH

New Zealand | NORTH ISLAND | LOWER NORTH ISLAND | SOUTH ISLAND