

QUATTRO

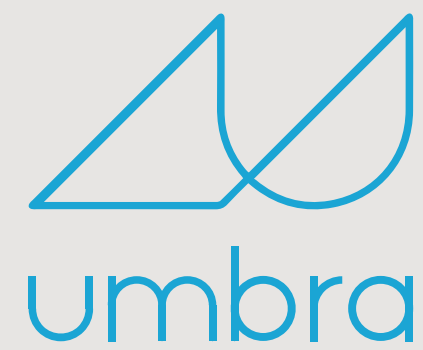

OUTDOOR  
LIVING

## QUATTRO

Distinctive aesthetic style with intelligent lighting control...

Quattro system that combines sophisticated technology and innovative concept is created to breathe new life into outdoor living areas with its modern architectural form along with a unique sense of design. Quattro is characterized by an advanced technology and exalting the product aesthetics.

Quattro has clean modern lines with a minimalist geometric appearance and it is the latest in Suntech's extensive contemporary collection of outdoor living solutions. System also introduces innovative world's first lighting that is integrated within the fabric layer by inspired unique asymmetrical lines. The patented lighting system is also equipped with RGB Led - Hidden Stripe lighting to vary color and Led Stripe Dimmer lighting on sides within the structure to provide intensity or HDD Lux High Power Led lighting options integrated on fabric.

Individual modules can be customised up to 5.5m wide and 8m projection with flexible installation methods such as integration to existing structures, wall mounting and free standing for larger outdoor areas.





# QUATTRO



■ Led Stripe Dimmer Lighting

■ RGB Led-Hidden Stripe Lighting

■ Linear Fabric Dimmer Led



**Led Stripe Dimmer Lighting** illuminates all around the system and creates a warm atmosphere. Dimmable Soft Led Stripe lighting on sides within the structure provides intensity of day light or cool white options.

**RGB Led-Hidden Stripe Lighting** provides ultimate luxury by creating distinctive atmosphere in outdoor living areas with infinite colour options.

**Hdd Lux High Power Led** integrated lighting profiles on fabric creates sufficient ambient light during evening.

**Linear Fabric Dimmer Led** innovative world's first lighting that is integrated within the fabric layer by inspired unique asymmetrical lines. The patented lighting system can be offered symmetrical or asymmetrical design to complete your minimalist style.



# QUATTRO

Flexible installation methods are available with wall mounting and free standing installations and they can even be served as a roof assembled to existing frameworks.



Self Standing  
Multiple Modules

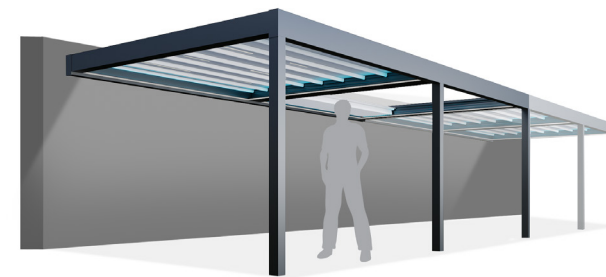
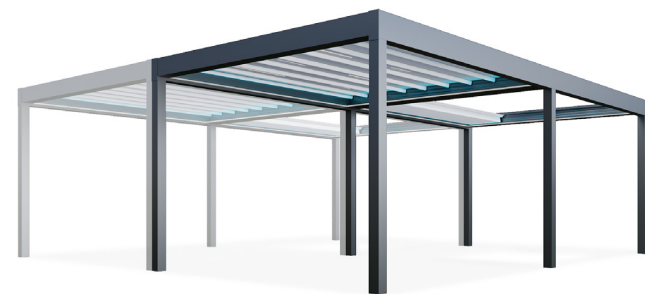

Wall Mounting  
Multiple Modules



Blocked assembly for customized modules with a wide range of flexible combinations.

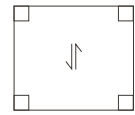

(w) Width  
1500 mm < 5500 mm

(p) Projection  
1500 mm < 8000 mm

(h) Height  
3000 mm

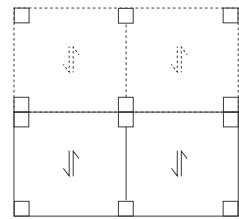
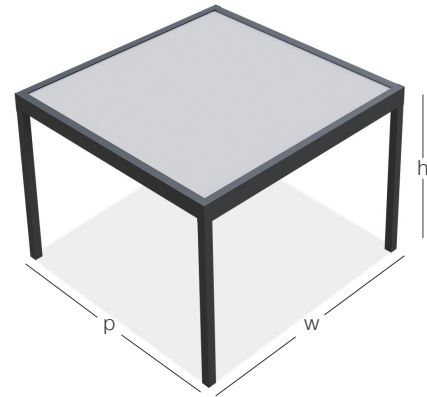

(w) Width  
3000 mm < 11000 mm

(p) Projection  
3000 mm < 16000 mm

(h) Height  
3000 mm

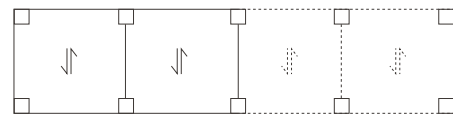
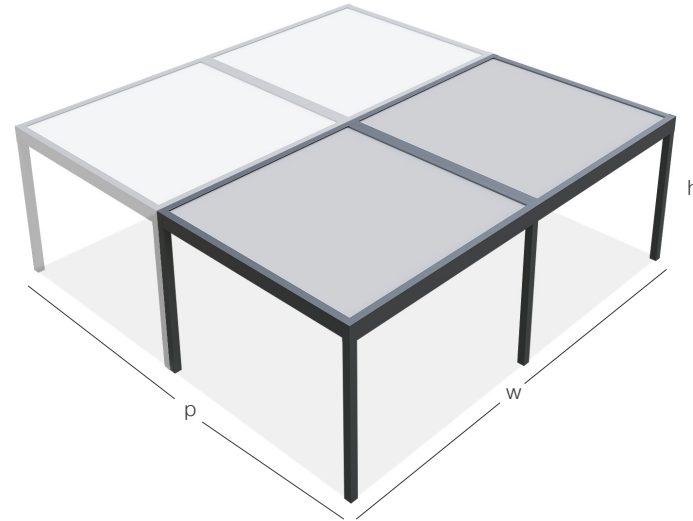

(w) Width  
6000 mm < 22000 mm

(p) Projection  
1500 mm < 8000 mm

(h) Height  
3000 mm

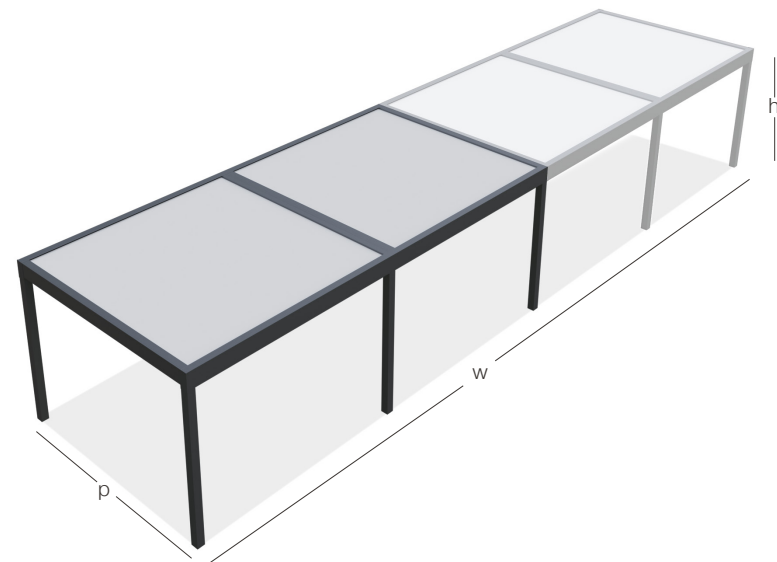

## Intra-Column Drainage Pipe

The water can be drained through internal drainage pipe and it eliminates factors that could block correct water flow. Intra-column drainage pipe collects the water and discharges to the ground.

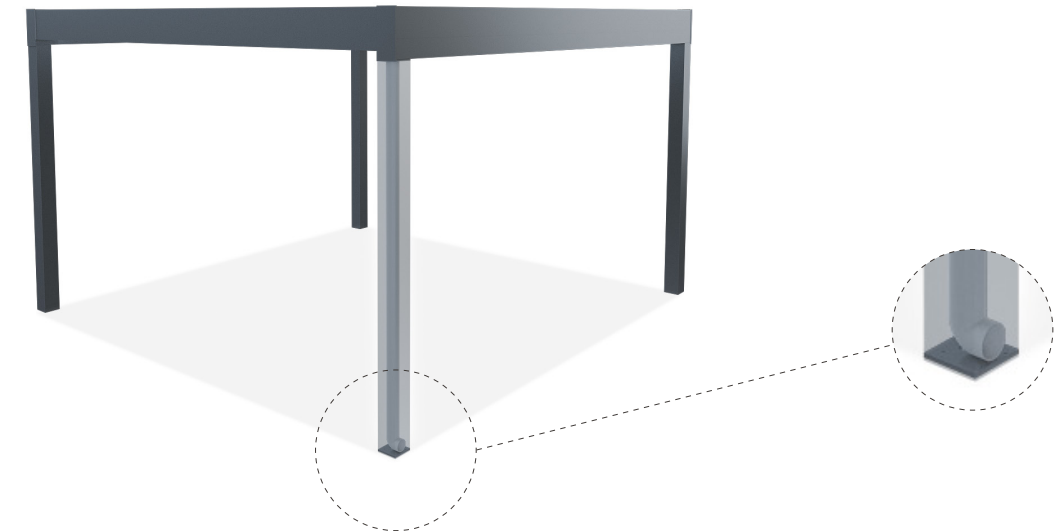
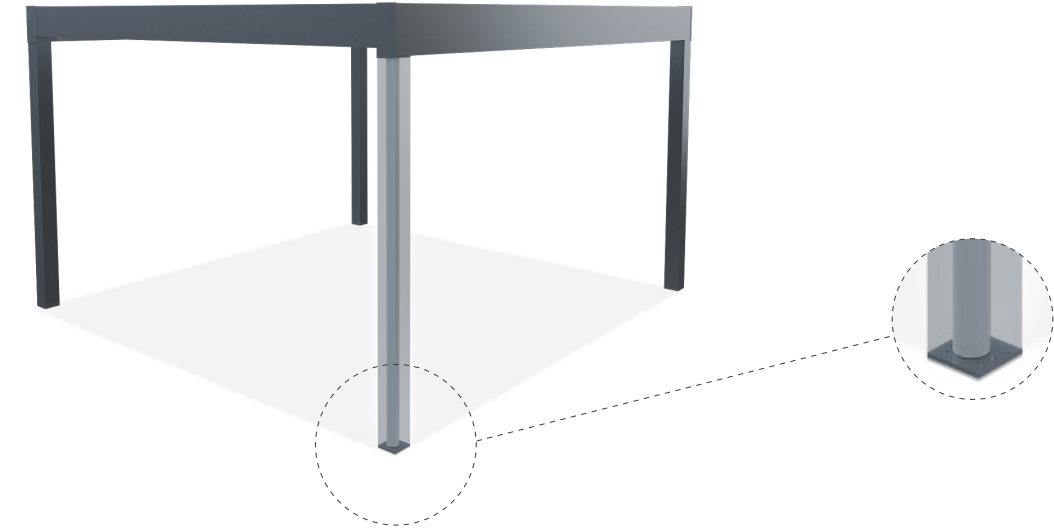

## Water Flow

The fabric is equipped with invisible bilateral slope that enables one side or alternating drainage through rafters while keeping flat appearance.

One Side Flow



Right Side Flow

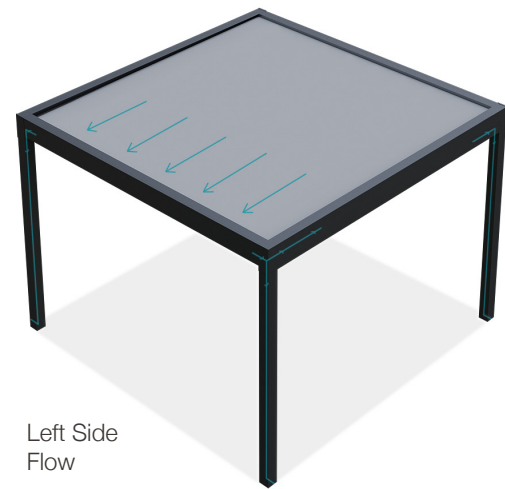
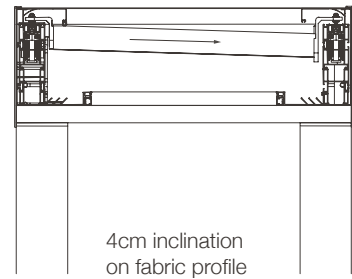

Left Side Flow

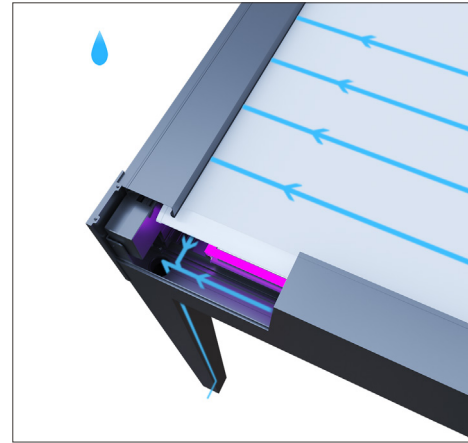
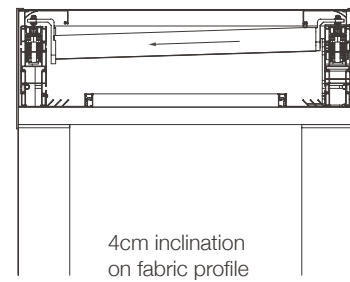

Alternating Flow



Double Sided Flow

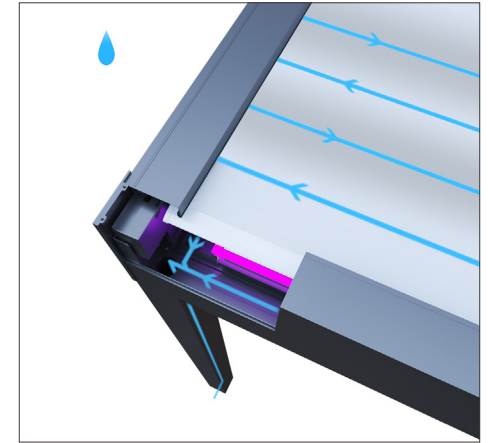
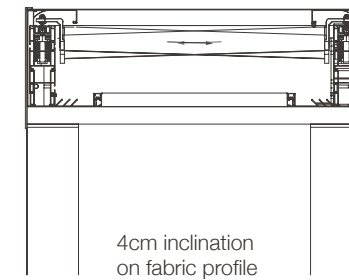

## Closures



**Sapphire/Cycle Guillotine Glass System**  
System can be adapted to Quattro system and offers a maximum clear span that provides unobstructed view & minimalistic style. The system is operated by just the touch of button.

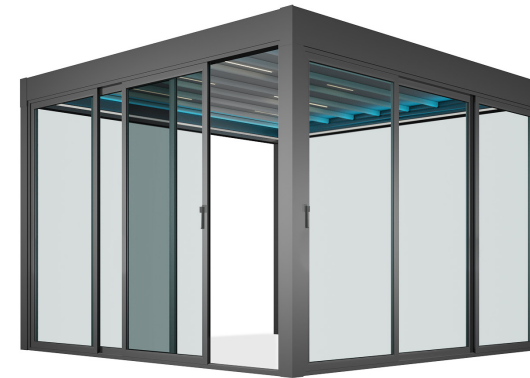

**Framee Sliding Glass System**  
Minimal line of Framee system is perfectly matching with modern architectural Quattro system by insulated fine-framed sliding glass panels. System offers a comfortable sliding with easy individual movement.

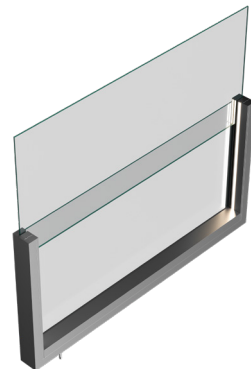

**Swind-Motorised Windbreaker System**  
Swind can be combined with also Quattro system and offers adequate wind breaking with the option of total transparency by incorporating the function of balustrade. Thanks to led stripe dimmer lighting integrated side frame the fixed panel assigns distinctive appeal. The system is modular and completely flexible as there are no limits in the horizontal direction that can be used to surround spaces of all types and sizes.

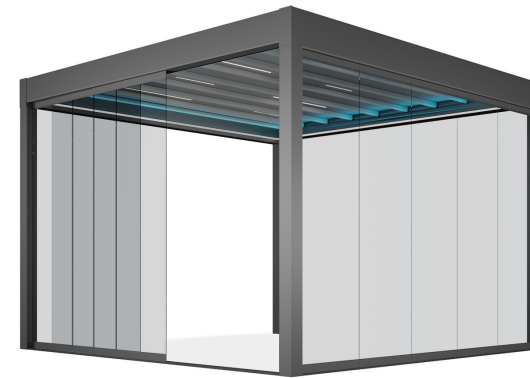

**Slidia Sliding Glass System**  
The combination of the sliding glass system with Quattro ensures efficacious protection from wind and rain. The aluminium frames which cover each glass panel provide maximum safety standards and practicality with elegance details.



**Violet Glass Balustrade System**  
The adaptability of Violet fixed balustrade glass with Quattro creates a stunning visual transparency without lacking of obstruction to lines of sight. The stylish lighting solution that is integrated underneath the glass highlights attractive aspect of the design by amplifying overall aesthetic of outdoors. Thanks to flexible and multiple modular implementations, system can be used to cover comprehensive areas without limitation in the horizontal direction.



**Vertex Zip Screen System**  
The minimalist, slimlane, contemporary design of the zip system provides comfortable shade and protects against the UV rays. The system includes motorised aluminium structure, entirely powder-coated with stainless steel bolts and screws.



**Wallfix Fixed Side Enclosure**  
The unique designed privacy of Wallfix side enclosure can be combined with Quattro system to optimise outdoor living areas visually.



# QUATTRO

## Operations

One Side



Alternating



## Lighting Options

Led Stripe Dimmer Lighting

Cool White



Day Light



RGB Led-Hidden Stripe Lighting



HDD Lux High Power Led Lighting



Linear Fabric Dimmer Led Lighting

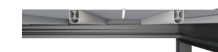

## Sensors

Rain Sensor 

Sun Sensor 

Wind Sensor 

Wind&Sun Sensor 

## Installation Types

Self Standing Single Module



Self Standing Multiple Modules



Wall Mounting Single Module

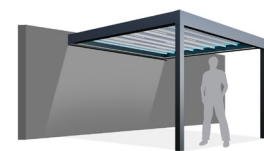

Wall Mounting Multiple Modules



## Closures

Sapphire & Cycle



Swind



Violet

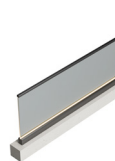

Framee

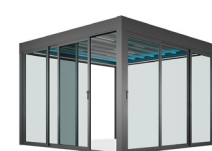

Slidia

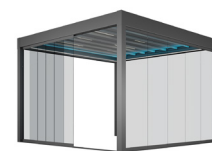

Vertex



Wallfix



## Technical Details



Max. width for single module	5500 mm
Max. projection single module	8000 mm
Rafter profile dimension	252x81 mm
Post dimension	160x160 mm
Fabric parking area	17%

Automation	included
Control unit	included
Led Stripe Dimmer	optional
RGB Led - Hidden Stripe lighting	optional
HDD Lux High Power Led lighting	optional
Dimmer Kit	optional
Linear Fabric Dimmer Led lighting	optional
Drainage pipe	optional
Flange	optional
Rain Sensor	optional
Wind Sensor	optional
Sun Sensor	optional
Wind&Sun Sensor	optional



# ALUMINUM

## basic

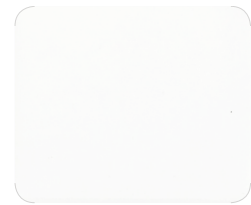

RAL 9016



RAL 1013



RAL 9006

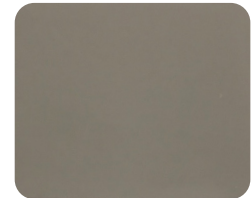

RAL 7006

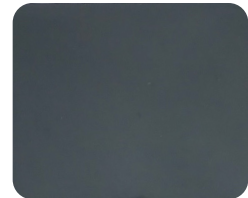

RAL 7016

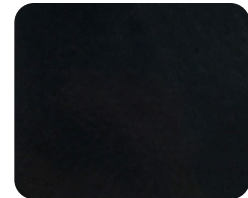

RAL 9005

## exclusive



OGN35



OS561



OY395



OGN39



ON617



ON611

## texture



ST9010

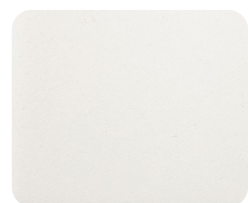

ST9001



ST1013

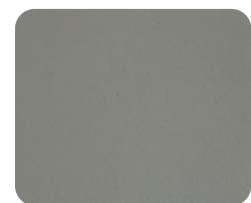

ST7039

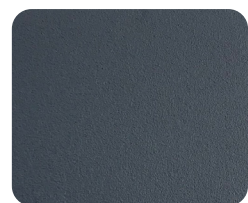

ST7016

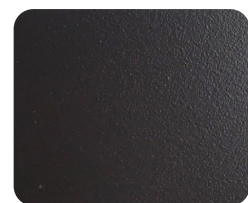

ST8019

# blackout fabric

## premium

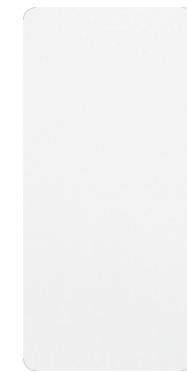

PW213/White

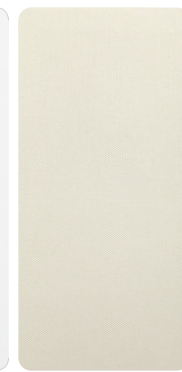

PC211/Cream

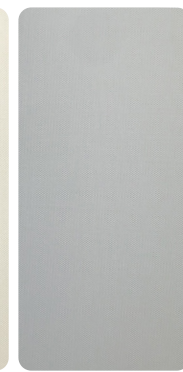

PG209/Grey

## basic

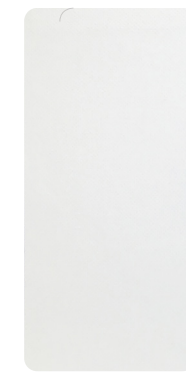

WT785/White

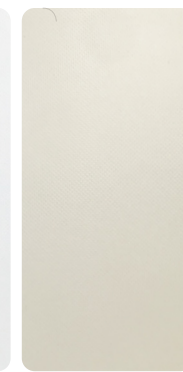

CR295/Cream

## matt

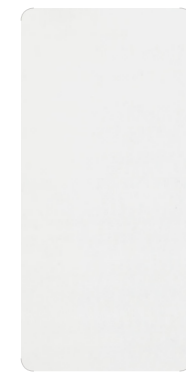

MW23/White

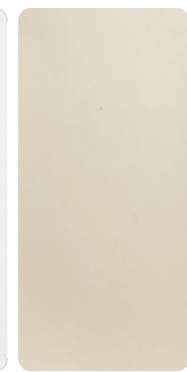

MC26/Cappuccino

# FABRIC

## xclusive

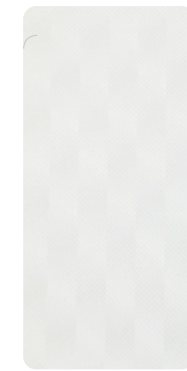

WTEX/White



CRMX/Cream



GRYX/Grey

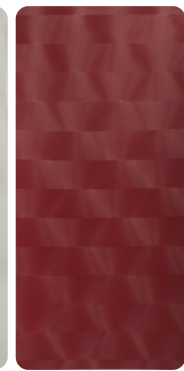

BRDX/Bordeaux

## matt/linear fabric led

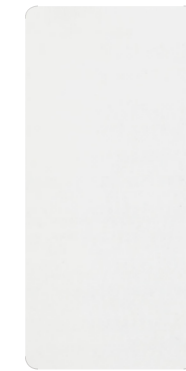

LW22/White

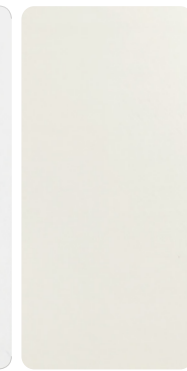

LCR33/Cream

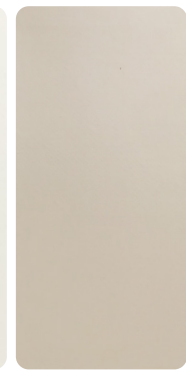

LC44/Cappuccino



LG66/Grey

## fabric

### semi-transparent



STRW22/White



STRB33/Black

The color and gloss level shown in this color swatch should be used only as a guide. All ral colors are available.

Premium fabric serie is produced from black-out PVC and has 5 years warranty. Cover is water & light proof and flame retardant. The color tone and pattern level shown in this color swatch should be used only as a guide.

[www.umbraoutdoorliving.com.au](http://www.umbraoutdoorliving.com.au)

[info@umbraoutdoorliving.com.au](mailto:info@umbraoutdoorliving.com.au)

1300 820 387

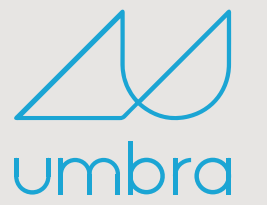

OUTDOOR  
LIVING

