



Plate Door Furniture

Plate Door Furniture

1800 Series Square End Plate Furniture

For a smart look choose this rectangular plate with bevelled edges and corners. It features concealed fixing on the outside plate.

Application

Designed for use with the Lockwood 3570 Series Mortice Locks and Latches.

Features and Specifications

Handing

Plates are not handed; lever may be reversed by removing stop screw, except those denoted by*.

Dimensions

166 x 48 x 12mm

Fixing

Plates are designed to fit back to back. If outside plate is specified with concealed fixing, then the inside plate must be visible fixed.

Door Thickness

External plates are supplied with fixing screws to suit door thickness between 32 and 50mm. Refer to lockweb.com.au for information on fixing screw and spindle options for thicker doors.

Finishes

Standard

Satin Chrome Brushed SC

Non Standard

Chrome Plate CP
Polished Brass PB
Polyester Powdercoat PPC

Other finishes on application.

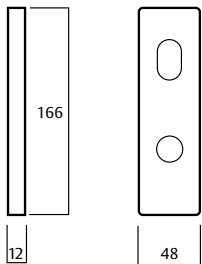

Levers and Knobs to Suit

For detailed information regarding brass levers refer to page 3.100

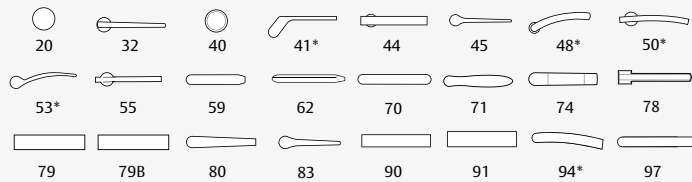

* Denotes handed levers

Plates and Functions

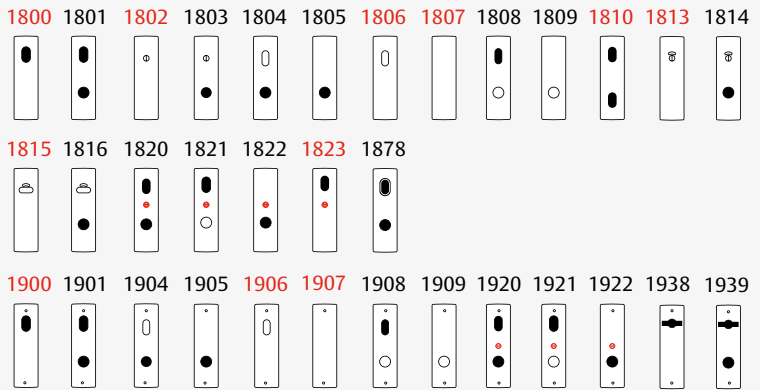

Plate Numbers marked red indicate no lever option

Plates and Functions Legend

Cylinder Hole		Fixed Lever		Indicating Turnknob	
Turnknob		Disabled		Indicating Slotted Turn	
Slotted Turn		LED		Lever	



Plate Door Furniture

2800 Series Round End Plate Furniture

A beautifully curved brass plate with bevelled edges and the benefit of concealed fixing on the external plate.

Application

Designed for use with Lockwood 3570 Series Mortice Locks and Latches.

Features and Specifications

Handing

Plates are not handed, lever may be reversed by removing stop screw, except those denoted by*:

Dimensions

166 x 48 x 12mm

Fixing

Plates are designed to fit back to back. If outside plate is specified with concealed fixing, then the inside plate must be visible fixed.

Door Thickness

External plates are supplied with fixing screws to suit door thickness between 32 and 50mm. Refer to lockweb.com.au for information on fixing screw and spindle options for thicker doors.

Finishes

Standard

Satin Chrome Brushed SC

Non Standard

Chrome Plate CP
Polished Brass PB
Polyester Powdercoat PPC

Other finishes on application.



Levers and Knobs to Suit

For detailed information regarding brass levers refer to page 3.100

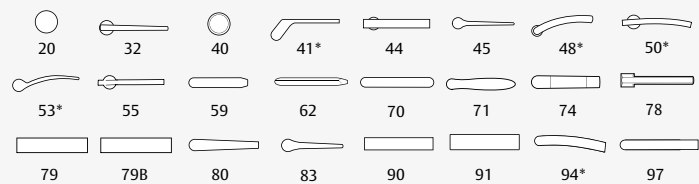

* Denotes handed levers

Plates and Functions

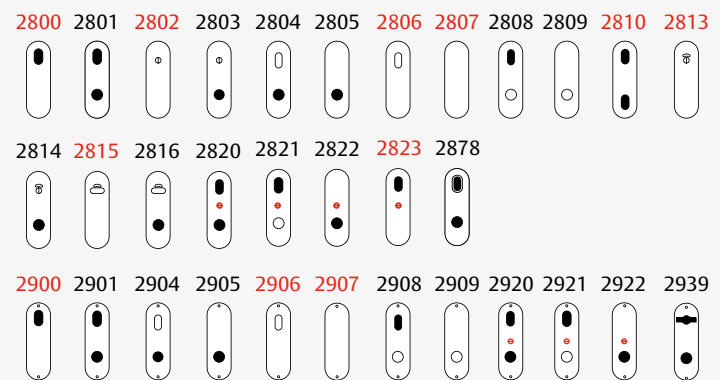

Plate numbers marked red indicate no lever option

Plates and Functions Legend

Cylinder Hole		Fixed Lever		Indicating Turnknob	
Turnknob		Disabled		Indicating Slotted Turn	
Slotted Turn		LED		Lever	

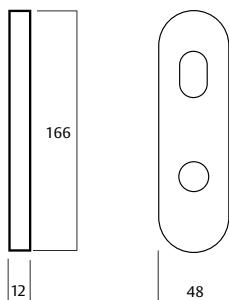

Plate Door Furniture

1800 and 2800 Series Ordering Procedure

Ordering Procedure

Sample part number 1801/48LCP is made up of several sections.
Choose your product by selecting an option from each section.

For example:

Lockwood 1800 and 2800 Series Plate Furniture

Plate Type	Plate Function	Lever/ Knob	Handing	Finish
18	01	48	L	CP

Plate Type	Lever/ Knob Type	Finish
Exterior Square End 18	20 53 *79	Chrome Plate CP
Interior Square End 19	32 55 79B	Satin Chrome Brushed SC
Exterior Round End 28	40 59 80	Polished Brass PB
Interior Round End 29	41* 62 83	
	44 70 90	
	45 71 91	
	48* 74 94*	
	50 78 97	

Plate Function
Cylinder Only 00
Cylinder & Lever 01
Emergency Turn Only 02
Emergency Turn & Lever 03
Turnknob & Lever 04
Lever Only 05
Turnknob Only 06
Plain Plate 07
Cylinder & Fixed Lever 08
Fixed Lever Only 09
Two Cylinders 10
Privacy Indicator Emergency Turn Only 13
Privacy Indicator Emergency Turn & Lever 14
Privacy Indicator Turnknob Only 15
Privacy Indicator Turnknob & Lever 16
Cylinder, Lever & LED 20
Cylinder, Fixed Lever & LED 21
Lever & LED 22
Cylinder & LED 23
Disabled Turn Only 38
Disabled Turn & Lever 39

Handing
Right Handed R
Left Handed L

NB: Omit if non-handed

* Denotes handed levers

Plate Door Furniture

Securafix® Series Plate Furniture

This unique fixing system provides concealed fixing on both sides of the door creating a more pleasing aesthetic whilst increasing the security of the installation. The plate tightening mechanism can be locked to prevent loosening, making Securafix furniture the ideal choice for style, security and durability.

Application

Lockwood 3670 Series Securafix Mortice Latches

Features and Specifications

Handing

All plates and levers are handed and are ordered as half sets.

Fixing

Lockwood plates are designed to fit back to back which are tightened from the front of the mortice lock by a hex key.

Door Thickness

Standard plates suit door thickness between 32 and 44mm.

Refer to ordering procedure on page 3.76 for information regarding plates for use on thicker doors.

Variations

Securafix® furniture is available on 1800 and 2800 Series Brass Plate Furniture.

Finishes

Standard

Satin Chrome Brushed SC

Non Standard

Chrome Plate CP

Polished Brass PB

Polyester Powdercoat PC

Other finishes on application.



Levers and Knobs to Suit

For detailed information regarding brass levers refer to page 3.100

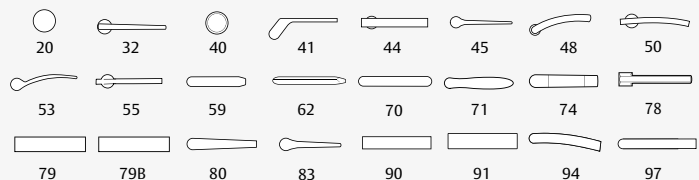

Plates and Functions

1800 1801 1804 1805 1820 1822 1839 1878

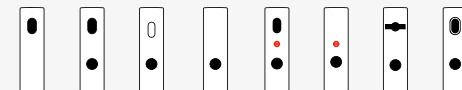

2800 2801 2804 2805 2820 2822 2839 2878

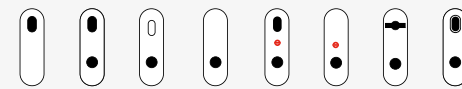

Plate numbers marked red indicate no lever option

Plates and Functions Legend

Cylinder Hole		Fixed Lever		Indicating Turnknob	
Turnknob		Disabled		Indicating Slotted Turn	
Slotted Turn		LED		Lever	



Rose Door Furniture

Securafix® Series Ordering Procedure

Ordering Procedure

Sample part number 1801SF/20RCP55 is made up of several sections. Choose your product by selecting an option from each section.

For example:

Lockwood 1800 and 2800 Series Plate Furniture with Securafix®

Plate	Function	Securafix	Lever/ Knob	Handing	Finish	Door Thickness
18	01	SF	20	R	CP	55

Plate	Securafix	Handing	Door Thickness
1800 Series Square End Plates	Securafix SF	Left Handed L	32 – 45mm (No Suffix)
2800 Series Round End Plates		Right Handed R	45 – 55mm 55
			55 – 65mm 65
			65 – 75mm 75

Function	Lever/Knob Type	Finish
Cylinder & Lever 01	20 53* 79	Chrome Plate CP
Turnknob & Lever 04	32 55 79B	Satin Chrome Brushed SC
Lever Only 05	40 59 80	Polished Brass PB
Cylinder, Lever & LED 20	41* 62 83	
Lever & LED 22	44 70 90	
Disabled Turn & Lever 39	45 71 91	
Prox, Cylinder & Lever 78	48* 74 94*	
	50 78 97	

Note: Applies to right handed plates only.

Plate Door Furniture

Proximity Furniture

Easy to install and operate, Lockwood Proximity Furniture is available in a wide range of stylish levers and finishes to enhance any contemporary building design, bringing a new dimension to commercial security locking solutions.

Proximity Mortice Lock Specifications

- Multivoltage 12-24VDC
- Field selectable fail safe/fail secure
- 60mm backset only

Monitoring

The following monitoring features are standard:

- Dual key override
- Deadlatched and locked
- Door closed
- Request to exit

Proximity Reader Specifications

- HID 125KHz proximity reader
- Wiegand data output
- Supply voltage: 5-12VDC
- Current requirements (stand by/peak)
25/90mA @ 5VDC, 15/125mA @ 12VDC
- Beeper activated when presenting proximity card
- Red/green led indication of reader/lock status

For details refer to 5.44



Plate Door Furniture

4800 Series Narrow Stile Plate Furniture

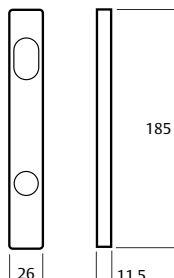

A slimline, rectangular brass plate that adds style to your choice of lever.

Application

Designed for use with Lockwood 3570 Series Mortice Latches (4600/4700) and 3580 Series Mortice Latches (4800/4900).

Note: certain lever designs are not compatible on short backset assemblies due to interference with the door stop. Refer to page 3.80 for lever/backset suitability on 4800/4900 Series Plates.

Features and Specifications

Dimensions

185 x 26 x 11.5mm

Fixing

Plates are designed to fit back to back. If outside plate is specified with concealed fixing, then the inside plate must be visible fixed. All lever handles are reversible, except those denoted by*.

Door Thickness

External plates are supplied with fixing screws to suit door thickness between 32 and 50mm. Refer to lockweb.com.au for information on fixing screw and spindle options for thicker doors.

Levers to Suit

For detailed information regarding brass levers refer to page 3.100

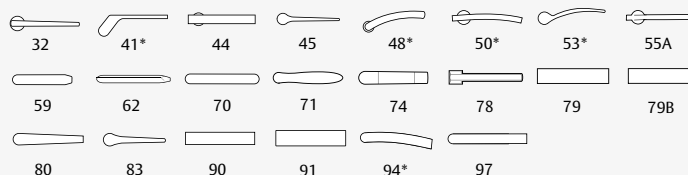

4800/4900 Plates and Functions (3580 Series)

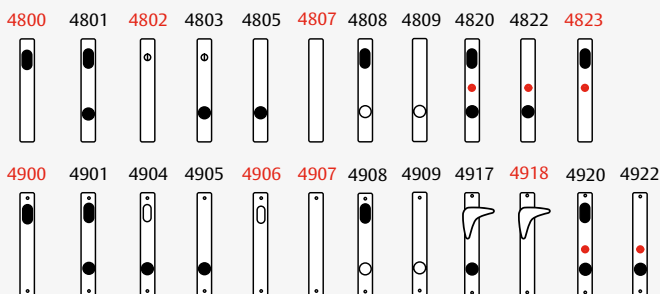

4600/4700 Plates and Functions (3570 Series)

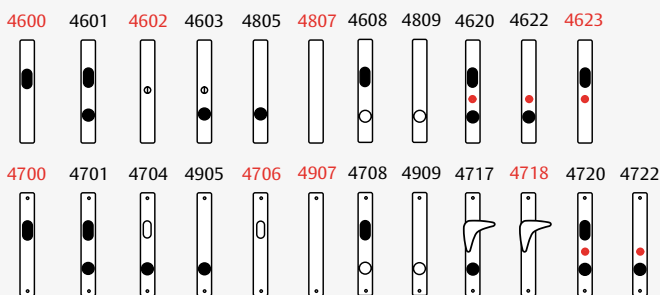

Plates and Functions Legend

Cylinder Hole		Fixed Lever		Indicating Turnknob	
Turnknob		Disabled		Indicating Slotted Turn	
Slotted Turn		LED		Lever	

* Denotes handed levers

Plate numbers marked red indicate no lever option

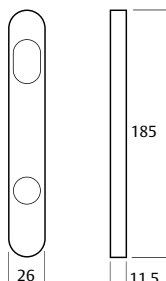

Plate Door Furniture

5800 Series Narrow Stile Plate Furniture



ASSA ABLOY



Functional, yet elegant, the soft lines of this round ended brass plate complement a wide range of levers.

Application

Designed for use with Lockwood 3570 Series Mortice Latches (5600/5700) and 3580 Series Mortice Latches (5800/5900).

Note: certain lever designs are not compatible on short backset assemblies due to interference with the door stop. Refer to page 3.80 for lever/backset suitability on 4800/4900 Series Plates.

Features and Specifications

Dimensions

185 x 26 x 11.5mm

Fixing

Plates are designed to fit back to back. If outside plate is specified with concealed fixing, then the inside plate must be visible fixed. All lever handles are reversible, except those denoted by *.

Door Thickness

External plates are supplied with fixing screws to suit door thickness between 32 and 50mm. Refer to lockweb.com.au for information on fixing screw and spindle options for thicker doors.



Levers to Suit

For detailed information regarding brass levers refer to page 3.100

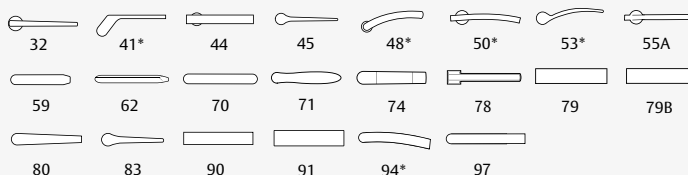

5800/5900 Plates and Functions (3580 Series)

5800 5801 5802 5803 5805 5807 5808 5809 5820 5822 5823

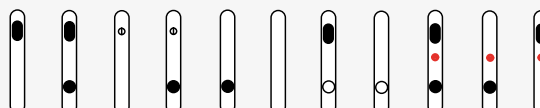

5900 5901 5904 5905 5906 5907 5908 5909 5917 5918 5920 5922

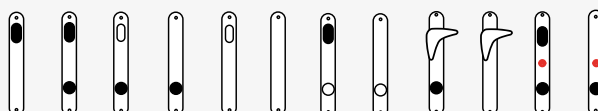

5600/5700 Plates and Functions (3570 Series)

5600 5601 5602 5603 5805 5807 5608 5809 5620 5622 5623

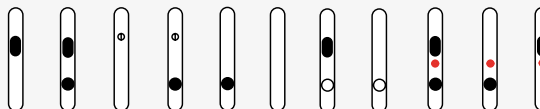

5700 5701 5704 5905 5706 5907 5708 5909 5717 5718 5720 5722

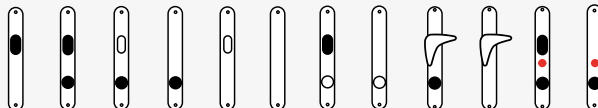

Plates and Functions Legend

Cylinder Hole		Fixed Lever		Indicating Turnknob	
Turnknob		Disabled		Indicating Slotted Turn	
Slotted Turn		LED		Lever	

* Denotes handed levers

Plate numbers marked red indicate no lever option

Plate Door Furniture

Lockwood 4800/5800 Series Plate Furniture

Backset Suitability Chart

Based on 12mm doorstop

Lever Number	Handed	3580 23mm	4580 25.4mm	5580 30mm	6580 38mm
32	No	No	No	Yes	Yes
41	Yes	No	No	Yes	Yes
44	No	No	No	No	No
45	No	No	No	Yes	Yes
48	Yes	Yes	Yes	Yes	Yes
50	Yes	No	No	No	No
53	Yes	No	No	Yes	Yes
55A	No	No	No	Yes	Yes
59	No	No	No	Yes	Yes
62	No	No	No	Yes	Yes
70	No	Yes	Yes	Yes	Yes
71	No	No	No	Yes	Yes
74	No	No	No	Yes	Yes
78	No	No	No	Yes	Yes
79	No	No	No	No	No
79B	No	No	No	Yes	Yes
80	No	No	Yes	Yes	Yes
83	No	No	No	Yes	Yes
90	No	No	No	Yes	Yes
91	No	No	No	Yes	Yes
94	Yes	Yes	Yes	Yes	Yes
97	No	Yes	Yes	Yes	Yes

Rose Door Furniture

4800 and 5800 Series Ordering Procedure



ASSA ABLOY

Ordering Procedure

Sample part number 4801/48LCP is made up of several sections. Choose your product by selecting an option from each section.

For example:

Lockwood 4800/5800, 4600/5600 Series Plate Furniture

Plate Type	Plate Function	Lever/ Knob	Handing	Finish
48	01	48	L	CP

Plate Type	Lever/Knob Type	Finish
3570	20 53* 79	Chrome Plate CP
Exterior Square End 46	32 55A 79B	Satin Chrome Brushed SC
Interior Square End 47	40 59 80	Polished Brass PB
Exterior Round End 56	41* 62 83	
Interior Round End 57	44 70 90	
	45 71 91	
3580	48* 74 94*	
Exterior Square End 48	50 78 97	
Interior Square End 49		
Exterior Round End 58		
Interior Round End 59		

* Denotes handed levers

Handing
Right Handed R
Left Handed L

NB: Omit if non-handed

Plate Function
Cylinder Only 00
Cylinder & Lever 01
Emergency Turn Only 02
Emergency Turn & Lever 03
Turnknob & Lever 04
Lever Only 05
Turnknob Only 06
Plain Plate 07
Fixed Lever & Cylinder 08
Fixed Lever Only 09
Boomerang Turn & Lever 17
Boomerang Turn Only 18
Cylinder, Lever & LED 20
Lever & LED 22
Cylinder & LED 23

Plate Door Furniture

200 Series Artefact Square Corner Plates

The 200 Series Door Furniture is 162mm square with square corners. Concealed fixed plates have studs with internal threads located in each corner, visible fixed plates have corresponding countersunk holes and are fixed back to back through the door.

Application

Designed for use with Lockwood 3570 Series Mortice Locks; Latches and Push and Pull doors.

Features and Specifications

Dimensions

162 x 162 x 3mm – aluminium

162 x 162 x 2mm – stainless steel and brass

Materials

Aluminium, brass and stainless steel

Door Thickness

35 to 45mm standard. For doors 45 to 55mm thick, specify long fixing screws SP2000-208.

Note: When using flush pulls back to back the minimum door thickness is 40mm.

Finishes

Standard

Natural Anodised Aluminium NT
Satin Stainless Steel SS

Non Standard

Polished Stainless Steel PS
Powdercoat PC
Marine Grade MG
Polished Brass PB

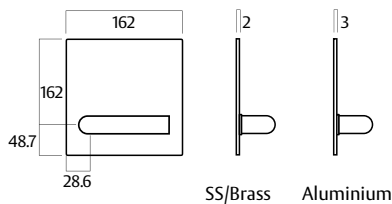

Levers and Knob to Suit



Brass levers and knobs also available on stainless steel and brass plates refer page 3.100

*Aluminium Only

Pull Handle to Suit

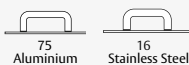

Plates

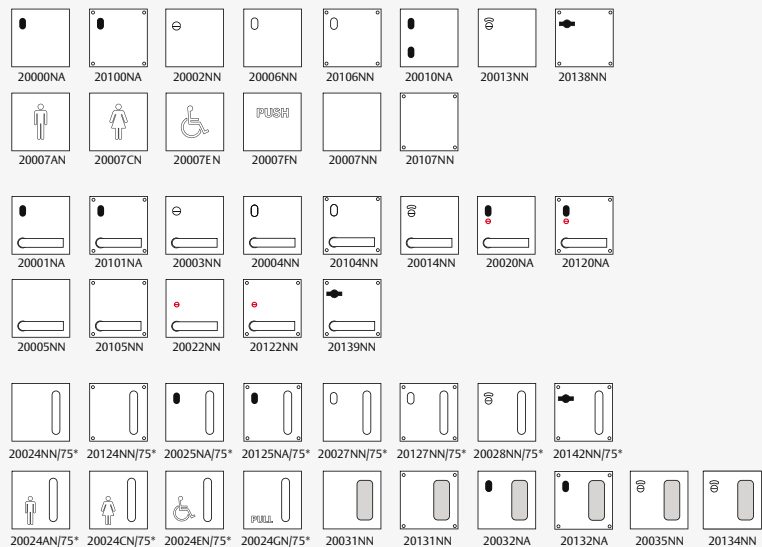

Legend

Cylinder Hole		Slotted Button		LED	
Turn-Snib		Disabled		Indicating Slotted Button	



FIRE RATED



D3 DURABILITY



S3 HIGH SECURITY



ANTI-CORROSION

Plate Door Furniture

202 Series Artefact 10mm Radius Corner Plates

The 202 Series Door Furniture is 162mm square with 10mm radius corners. Concealed fixed plates have studs with internal threads located in each corner, visible fixed plates have corresponding countersunk holes and are fixed back to back through the door.

Application

Designed for use with Lockwood 3570 Series Mortice Locks; Latches and Push and Pull doors.

Features and Specifications

Dimensions

162 x 162 x 3mm – aluminium

162 x 162 x 2mm – stainless steel and brass

Materials

Aluminium, stainless steel and brass.

Door Thickness

35 to 45mm standard. For doors 45 to 55mm thick, specify long fixing screws SP2000-208.

Note: When using flush pulls back to back the minimum door thickness is 40mm.

Finishes

Standard

Natural Anodised Aluminium

Stainless Steel

NT

SS

Non Standard

Polished Stainless Steel

Powdercoat

Marine Grade

Polished Brass

PS

PC

MG

PB

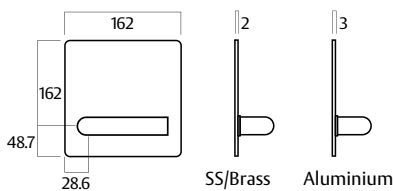

Levers and Knob to Suit



Brass levers and knobs also available on stainless steel and brass plates refer page 3.100

*Aluminium Only

Pull Handle to Suit

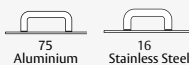

Plates

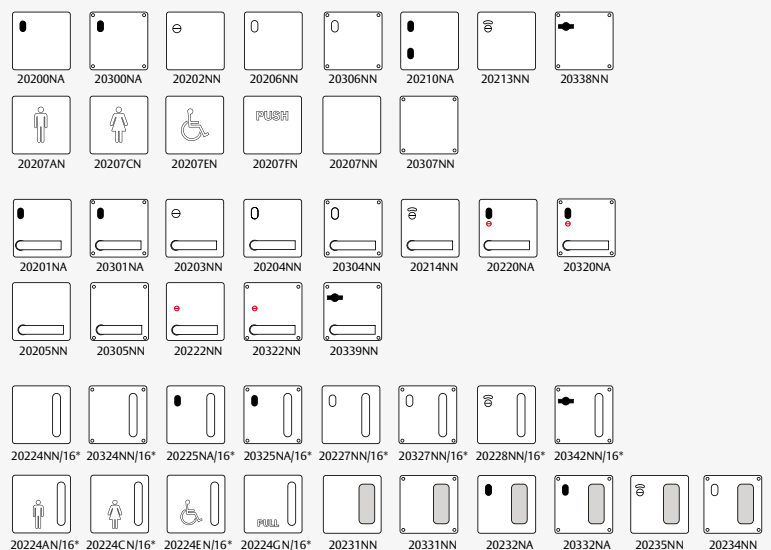

Legend

Cylinder Hole		Slotted Button		LED	
Turn-Snib		Disabled		Indicating Slotted Button	



FIRE RATED



DURABILITY



HIGH SECURITY



ANTI-CORROSION

Plate Door Furniture

212 Series Artefact Oval Plates

The 212 Series Door Furniture is 162mm long x 50mm wide with radius ends. Concealed fixed plates have studs with internal threads located top and bottom, visible fixed plates have corresponding countersunk holes and are fixed back to back through the door.

Application

Designed for use with Lockwood 3570 Series Mortice Latches.

Features and Specifications

Dimensions

162 x 50 x 3mm – aluminium

162 x 50 x 2mm – stainless steel and brass

Materials

Aluminium, stainless steel or brass.

Door Thickness

35 to 45mm standard. For doors 45 to 55mm thick, specify long fixing screws SP2000-208.

Finishes

Standard

Natural Anodised Aluminium NT
Stainless Steel SS

Non Standard

Polished Stainless Steel PS
Powdercoat PC
Marine Grade MG
Polished Brass PB

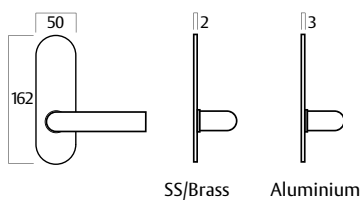

Levers and Knob to Suit



Brass levers and knobs also available on stainless steel and brass plates refer page 3.100

*Aluminium Only

Pull Handle to Suit

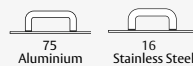

Plates

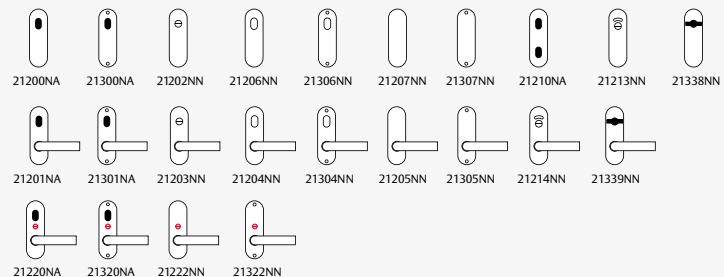

Legend

Cylinder Hole		Slotted Button		LED	
Turn-Snib		Disabled		Indicating Slotted Button	



FIRE RATED



DURABILITY



HIGH SECURITY



ANTI-CORROSION

Plate Door Furniture

224 Series Artefact Rectangular Plates



ASSA ABLOY

The 224 Series Door Furniture is 162mm long x 50mm wide with square ends. Concealed fixed plates have studs with internal threads located top and bottom, visible fixed plates have corresponding countersunk holes and are fixed back to back through the door.

Application

Designed for use with Lockwood 3570 Series Mortice Latches.

Features and Specifications

Dimensions

162 x 50 x 2mm – stainless steel

Materials

Stainless Steel only.

Door Thickness

35 to 45mm standard. For doors 45 to 55mm thick, specify long fixing screws SP2000-208.

Standard Finishes

Stainless Steel

SS

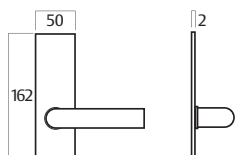

Stainless Steel

Levers and Knob to Suit



Brass levers and knobs also available refer page 3.100

Pull Handle to Suit



16
Stainless Steel

Plates

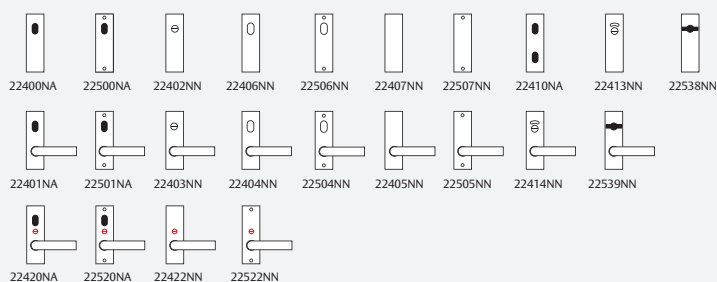

Legend

Cylinder Hole		Slotted Button		LED	
Turn-Snib		Disabled		Indicating Slotted Button	



FIRE RATED



DURABILITY



HIGH SECURITY



ANTI-CORROSION

Plate Door Furniture

Artefact Ordering Procedure

Ordering Procedure

Sample part number 20001NA/96LSS is made up of several sections. Choose your product by selecting an option from each section.

For example:

200 Series

Plate Type	Plate Function	Engraving	Cylinder Shape	Lever/ Knob	Handing	Finish
200	01	N	A	96	L	SS

Plate Type	Plate Function	Engraving	Lever/ Knob Type
Exterior Plate (162 x 162) – Square Corners 200	Cylinder Only 00 Cylinder & Lever 01	A – G Outlined Infill R – X Full Infill	Brass Levers and Knobs 20 53* 79 32 55 79B 40 59 80 41* 62 83 44 70 90 45 71 91 48* 74 94* 50 78 97
Interior Plate (162 x 162) – Square Corners 201	Emergency Turn Only 02 Emergency Turn & Lever 03	Male symbol A R Male text B S Female symbol C T Female text D U	Stainless Steel Levers 96 98
Exterior Plate (162 x 162) – Radius Corners 202	Turn Knob & Lever 04 Lever Only 05	Disabled symbol E V Push text F W Pull text G X	Aluminium Levers/Knobs 20 88 96 98
Interior Plate (162 x 162) – Radius Corners 203	Turn Knob Only 06 Plain Plate 07	Unisex symbol H Y No option N Miscellaneous text* P Corporate Engraving** Q	Brass Pull Handles 01 05
Exterior Plate (162 x 50) – Oval 212	Cylinder & Fixed Lever 08 Fixed Lever Only 09		Stainless Steel Pull Handles 16
Interior Plate (162 x 50) – Oval 213	Dual Cylinder 10 Privacy Indicator Emergency Turn Only 13		Aluminium Pull Handles 75
Exterior Plate (162 x 50) – Rectangular 224	Privacy Indicator Emergency Turn & Lever 14 Privacy Indicator Turn Knob Only 15		* Denotes handed levers
Interior Plate (162 x 50) – Rectangular 225	Privacy Indicator Turn Knob & Lever 16 Cylinder, Lever & LED 20 Cylinder, Fixed Lever & LED 21 Lever & LED 22 Cylinder & LED 23 Pull Handle Only 24 Pull Handle & Cylinder 25 Pull Handle & Emergency Turn 26 Pull Handle & Turn Knob 27 Pull Handle & Privacy Indicator Emergency Turn 28 Pull Handle & Privacy Indicator Turn Knob 29 Pull Handle & Dual Cylinder 30 Flush Pull Only 31 Flush Pull & Cylinder 32 Flush Pull & Emergency Turn 33 Flush Pull & Turn Knob 34 Flush Pull & Privacy Indicator Emergency Turn 35 Flush Pull & Privacy Indicator Turn Knob 36 Flush Pull & Dual Cylinder 37 Disabled Turn Only 38 Disabled Turn & Lever 39 Pull Handle & Disabled Turn 42		Handing Left Handed L Right Handed R
		Cylinder Shape Oval Cylinder – 32mm (H) x 18mm (W) Lockwood 570 Cylinders A Guarded Oval Cylinder – 32mm (H) x 18mm (W) Lockwood 570 Cylinders B No Cylinder Function N	Finish Stainless Steel Finishes Satin Stainless Steel SS Polished Stainless Steel PS Powdercoat PC Marine Grade MG Aluminium Finishes Natural Anodised NT Brass Finishes Polished Brass PB

Plate Door Furniture

Detention Series Furniture – Square Plate

Description

A heavy duty plate designed for use in hospitals and detention facilities. Styled for institutional use, this plate has six fixing points to ensure that it is well secured to the door. Plates are designed to be free of ligature points.

Application

Lockwood 3570 Series Mortice Locks and Lockwood 3579 Secure Area Rated Locks.

Features and Specifications

- Anti-ligature
- Covers fixing holes from existing Artefact 200 Series Furniture
- Detention furniture turns feature a clutching mechanism that allows the cylinder to retract the bolt even if the turn knob is held from the inside.

Dimensions

162mm x 180mm x 2mm: base plate

161mm x 75mm x 3mm: bevelled top plate

Handing

All plates are handed except 220D07 and 220D31, which are non-handed when ordered without engraving.

Materials

Stainless steel

Fixing

- Six fixing points
- 220D series plates have concealed fixings
- 221D series plates have visible fixings

Door Thickness

35mm minimum, 45mm maximum

For thicker doors, longer screws are required.

Note: A minimum door thickness of 50mm is required to fit flush pulls back to back.

Standard Finish

Satin Stainless Steel SS



Lever and Knob Selection

Standard Knob 21

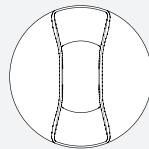

Webbed Knob 22

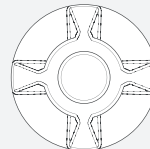

Lever 23

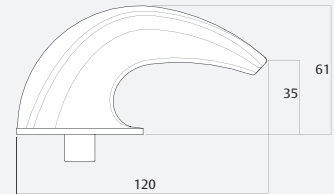
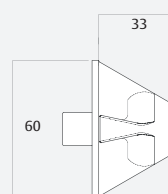
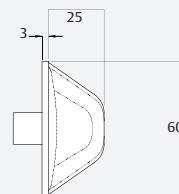
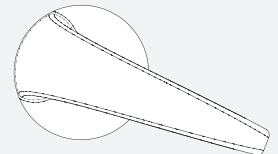
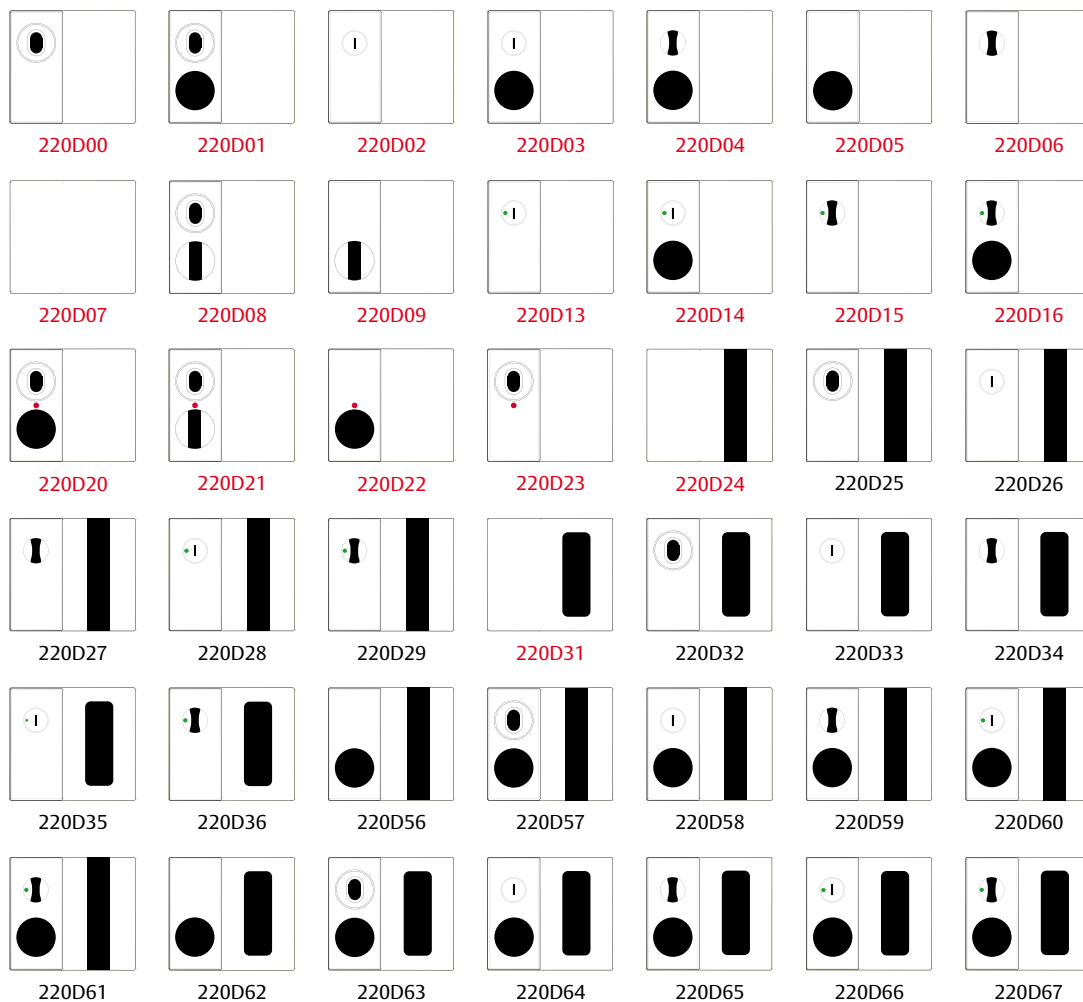

Plate Door Furniture

Detention Series Furniture – Square Plate Functions



Legend:

	Cylinder Hole		Knob/Lever		Fixed Knob/Lever		Turn Snib		Emergency Turn
	Privacy Indicator Turn Snib		Privacy Indicator Emergency Turn		LED		Pull Handle		Flush Pull

Cylinder guards must be ordered separately. Only the plate functions shown above in red are available with engraving.

Plate Door Furniture

Detention Series Furniture – Rectangular Plate

Description

This smaller plate range has been designed for use in detention facilities such as hospitals where domestic aesthetics are preferred over institutional type styling. Plates are designed to be free of ligature points.

Application

Lockwood 3570 Series Mortice Locks and Lockwood 3579 Secure Area Rated Locks.

Features and Specifications

- Anti-ligature
- Covers fixing holes from existing 212 Series Artefact Plates
- Detention furniture turns feature a clutching mechanism that allows the cylinder to retract the bolt even if the turn knob is held from the inside.

Dimensions

162mm x 76mm x 2mm: base plate

161mm x 75mm x 3mm: bevelled top plate

Handing

Only plates with levers and/or turn knobs are handed.

Materials

Stainless steel

Fixing

- Four fixing points
- 222D series plates have concealed fixings
- 223D series plates have visible fixings

Door Thickness

35mm minimum, 45mm maximum

For thicker doors, longer screws are required.

Standard Finishes

Satin Stainless Steel SS



Lever and Knob Selection

Standard Knob 21

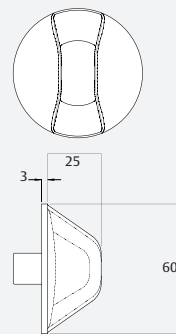

Webbed Knob 22

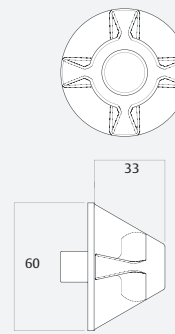

Lever 23

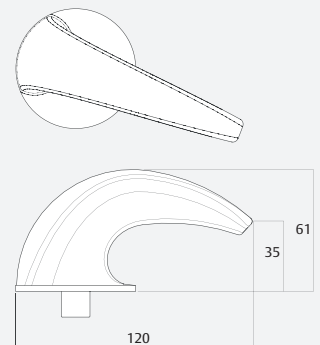

FIRE RATED



DURABILITY



HIGH SECURITY



ANTI-CORROSION

Plate Door Furniture

Detention Series Furniture –Rectangular Plate Functions

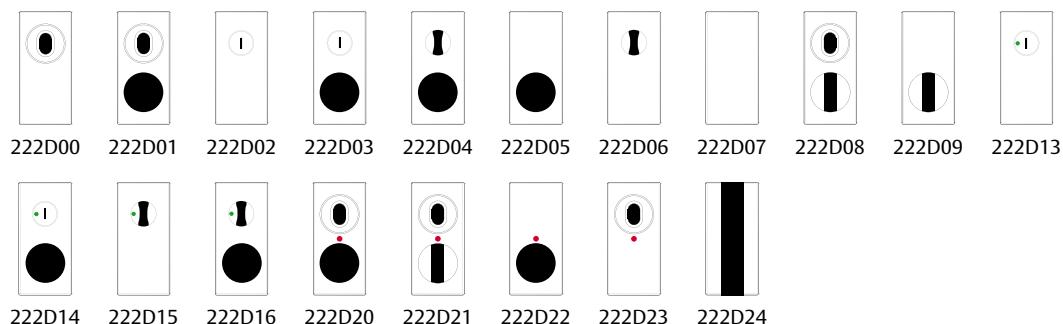

Legend:	Cylinder Hole	Knob/Lever	Fixed Knob/Lever	Turn Snib	Emergency Turn
	Privacy Indicator Turn Snib	Privacy Indicator Emergency Turn	LED	Pull Handle	Flush Pull

Note: Only plates with levers and/or turn knobs are handed. 223D Series have visible fixings.



Plate Door Furniture

Detention Series Furniture – Accessories

Knobs and Lever

Standard Knob 21

Simple yet functional, this knob has soft edges to minimise impact injuries and anti-ligature features that make it suitable for use in detention facilities.

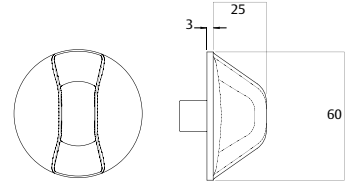

Webbed Knob 22

The webbed knob combines pleasing aesthetics, comfortable grip and anti-ligature features to provide a solution for any environment.

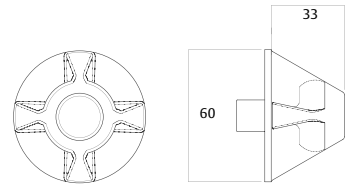

Detention Lever 23

Ergonomically designed to maximise grip, the detention lever is suitable for use in hospitals and minimum security applications. It caters especially for the elderly or people with arthritic conditions.

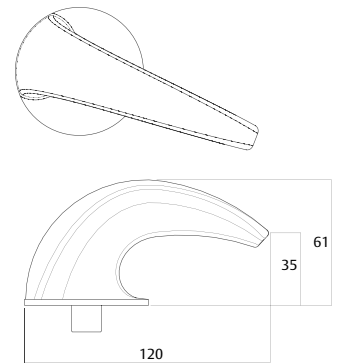

Turns

Emergency Turn

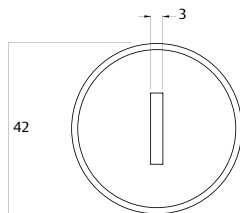

Turn Knob

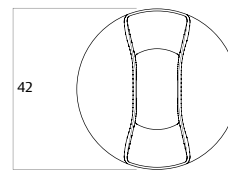

Indicating Emergency Turn

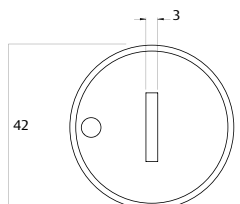

Indicating Turn Knob

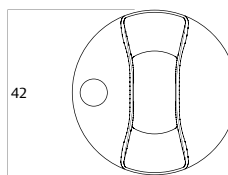

Plate Door Furniture

Detention Series Furniture – Accessories

Pulls

Flush Pull

The detention flush pull has been designed to maximise grip and eliminate the possibility of hiding objects in the cavity.

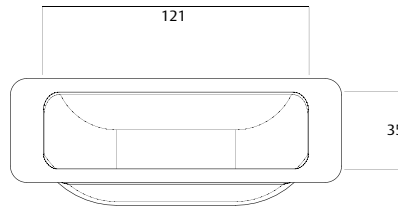

Standard Pull

The detention pull allows for a firm grip and can be used to open heavy doors. Also designed to be free of hanging points.

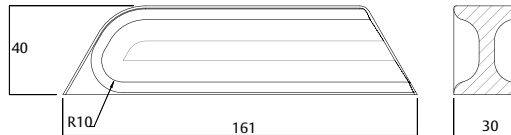

Cylinder Guards

Description

Cylinder guards must be fitted with any cylinder plate function. Guards are available to suit different door thicknesses.

Part Number	Door Thickness Suitability
220D00/40SS	Suit doors 35-40mm
220D00/45SS	Suit doors 40-45mm
220D00/50SS	Suit doors 45-50mm
220D00/55SS	Suit doors 50-55mm
220D00/60SS	Suit doors 55-60mm



Fixing Screws

Torx anti-tamper, snake-eye and standard screws are available in accessory packs to suit different door thicknesses. Only standard screws to suit doors 35mm – 45mm thick are supplied with furniture. Other variations need to be ordered separately using part numbers specified.

All accessory packs contain six screws.

Part Number	Description	Door Thickness Suitability
220D11/45	Torx Anti-tamper Screws	35 - 45mm
220D11/55	Torx Anti-tamper Screws	45 - 55mm
220D11/65	Torx Anti-tamper Screws	55 - 65mm
220D12/45	Standard Screws	35 - 45mm
220D12/55	Standard Screws	45 - 55mm
220D12/65	Standard Screws	55 - 65mm
220D13/50	Snake-eye Screws	35 - 50mm

Plate Door Furniture

Detention Series Furniture Ordering Procedure

Ordering Procedure

Sample part number 220D01NA/21LSS is made up of several sections.
Choose your product by selecting an option from each section.

For example:

Plate	Function	Engraving Options	Cylinder Options	Lever/ Knob	Handing	Finish
220	D 01	N	A	21	L	SS

Plate	Function	Engraving Options	Cylinder Options	Lever/ Knob	Handing	Finish																																																																																																																			
<table border="1"> <thead> <tr> <th>Plate</th> <th>Price</th> </tr> </thead> <tbody> <tr> <td>Concealed Fix 162mm x 180mm</td> <td>220</td> </tr> <tr> <td>Visible Fix 162mm x 180mm</td> <td>221</td> </tr> <tr> <td>Concealed Fix 162mm x 76mm</td> <td>222</td> </tr> <tr> <td>Visible Fix 162mm x 76mm</td> <td>223</td> </tr> </tbody> </table>	Plate	Price	Concealed Fix 162mm x 180mm	220	Visible Fix 162mm x 180mm	221	Concealed Fix 162mm x 76mm	222	Visible Fix 162mm x 76mm	223	<table border="1"> <thead> <tr> <th>Function</th> <th>Price</th> </tr> </thead> <tbody> <tr><td>Cylinder Only</td><td>00</td></tr> <tr><td>Cylinder and Lever/ Knob</td><td>01</td></tr> <tr><td>Emergency Turn Only</td><td>02</td></tr> <tr><td>Emergency Turn and Lever</td><td>03</td></tr> <tr><td>Turn Snib and Lever/ Knob</td><td>04</td></tr> <tr><td>Lever/ Knob Only</td><td>05</td></tr> <tr><td>Turn Snib Only</td><td>06</td></tr> <tr><td>Plain Plate</td><td>07</td></tr> <tr><td>Cylinder and Fixed Lever/ Knob</td><td>08</td></tr> <tr><td>Fixed Lever/ Knob Only</td><td>09</td></tr> <tr><td>Privacy Indicator Emergency Turn Only</td><td>13</td></tr> <tr><td>Privacy Indicator Emergency Turn and Lever/ Knob</td><td>14</td></tr> <tr><td>Privacy Indicator Turn Snib Only</td><td>15</td></tr> <tr><td>Privacy Indicator Turn Snib and Lever/ Knob</td><td>16</td></tr> <tr><td>Cylinder, Lever/ Knob and LED</td><td>20</td></tr> <tr><td>Cylinder, Fixed Lever/ Knob and LED</td><td>21</td></tr> <tr><td>Lever/ Knob and LED</td><td>22</td></tr> <tr><td>Cylinder and LED</td><td>23</td></tr> <tr><td>Pull Handle Only</td><td>24</td></tr> <tr><td>Pull Handle and Cylinder</td><td>25</td></tr> <tr><td>Pull Handle and Emergency Turn</td><td>26</td></tr> <tr><td>Pull Handle and Turn Snib</td><td>27</td></tr> <tr><td>Pull Handle and Privacy Indicator Emergency Turn</td><td>28</td></tr> <tr><td>Pull Handle and Privacy Indicator Turn Snib</td><td>29</td></tr> <tr><td>Flush Pull Only</td><td>31</td></tr> <tr><td>Flush Pull and Cylinder</td><td>32</td></tr> <tr><td>Flush Pull and Emergency Turn</td><td>33</td></tr> <tr><td>Flush Pull and Turn Snib</td><td>34</td></tr> </tbody> </table>	Function	Price	Cylinder Only	00	Cylinder and Lever/ Knob	01	Emergency Turn Only	02	Emergency Turn and Lever	03	Turn Snib and Lever/ Knob	04	Lever/ Knob Only	05	Turn Snib Only	06	Plain Plate	07	Cylinder and Fixed Lever/ Knob	08	Fixed Lever/ Knob Only	09	Privacy Indicator Emergency Turn Only	13	Privacy Indicator Emergency Turn and Lever/ Knob	14	Privacy Indicator Turn Snib Only	15	Privacy Indicator Turn Snib and Lever/ Knob	16	Cylinder, Lever/ Knob and LED	20	Cylinder, Fixed Lever/ Knob and LED	21	Lever/ Knob and LED	22	Cylinder and LED	23	Pull Handle Only	24	Pull Handle and Cylinder	25	Pull Handle and Emergency Turn	26	Pull Handle and Turn Snib	27	Pull Handle and Privacy Indicator Emergency Turn	28	Pull Handle and Privacy Indicator Turn Snib	29	Flush Pull Only	31	Flush Pull and Cylinder	32	Flush Pull and Emergency Turn	33	Flush Pull and Turn Snib	34	<table border="1"> <thead> <tr> <th>Engraving Options</th> <th>Price</th> </tr> </thead> <tbody> <tr><td>Flush Pull and Privacy Indicator Emergency Turn</td><td>35</td></tr> <tr><td>Flush Pull and Privacy Indicator Turn Snib</td><td>36</td></tr> <tr><td>Pull Handle and Knob/ Lever</td><td>56</td></tr> <tr><td>Pull Handle, Cylinder and Knob/ Lever</td><td>57</td></tr> <tr><td>Pull Handle, Emergency Turn and Knob/ Lever</td><td>58</td></tr> <tr><td>Pull Handle, Turn Snib and Knob/ Lever</td><td>59</td></tr> <tr><td>Pull Handle, Privacy Indicator Emergency Turn and Knob/ Lever</td><td>60</td></tr> <tr><td>Pull Handle, Privacy Indicator Turn Snib and Knob/ Lever</td><td>61</td></tr> <tr><td>Flush Pull and Lever/ Knob</td><td>62</td></tr> <tr><td>Flush Pull and Cylinder and Lever/ Knob</td><td>63</td></tr> <tr><td>Flush Pull and Emergency Turn and Lever/ Knob</td><td>64</td></tr> <tr><td>Flush Pull and Turn Snib and Lever/ Knob</td><td>65</td></tr> <tr><td>Flush Pull and Privacy Indicator Emergency Turn and Lever/ Knob</td><td>66</td></tr> <tr><td>Flush Pull and Privacy Indicator Turn Snib and Knob/ Lever</td><td>67</td></tr> </tbody> </table>	Engraving Options	Price	Flush Pull and Privacy Indicator Emergency Turn	35	Flush Pull and Privacy Indicator Turn Snib	36	Pull Handle and Knob/ Lever	56	Pull Handle, Cylinder and Knob/ Lever	57	Pull Handle, Emergency Turn and Knob/ Lever	58	Pull Handle, Turn Snib and Knob/ Lever	59	Pull Handle, Privacy Indicator Emergency Turn and Knob/ Lever	60	Pull Handle, Privacy Indicator Turn Snib and Knob/ Lever	61	Flush Pull and Lever/ Knob	62	Flush Pull and Cylinder and Lever/ Knob	63	Flush Pull and Emergency Turn and Lever/ Knob	64	Flush Pull and Turn Snib and Lever/ Knob	65	Flush Pull and Privacy Indicator Emergency Turn and Lever/ Knob	66	Flush Pull and Privacy Indicator Turn Snib and Knob/ Lever	67	<table border="1"> <thead> <tr> <th>Lever/ Knob</th> <th>Price</th> </tr> </thead> <tbody> <tr><td>Standard Knob</td><td>21</td></tr> <tr><td>Webbed Knob</td><td>22</td></tr> <tr><td>Lever</td><td>23</td></tr> </tbody> </table>	Lever/ Knob	Price	Standard Knob	21	Webbed Knob	22	Lever	23	<table border="1"> <thead> <tr> <th>Handing</th> <th>Price</th> </tr> </thead> <tbody> <tr><td>Left Handed</td><td>L</td></tr> <tr><td>Right Handed</td><td>R</td></tr> </tbody> </table>	Handing	Price	Left Handed	L	Right Handed	R	<table border="1"> <thead> <tr> <th>Finish</th> <th>Price</th> </tr> </thead> <tbody> <tr><td>Satin Stainless Steel</td><td>SS</td></tr> </tbody> </table>	Finish	Price	Satin Stainless Steel	SS
Plate	Price																																																																																																																								
Concealed Fix 162mm x 180mm	220																																																																																																																								
Visible Fix 162mm x 180mm	221																																																																																																																								
Concealed Fix 162mm x 76mm	222																																																																																																																								
Visible Fix 162mm x 76mm	223																																																																																																																								
Function	Price																																																																																																																								
Cylinder Only	00																																																																																																																								
Cylinder and Lever/ Knob	01																																																																																																																								
Emergency Turn Only	02																																																																																																																								
Emergency Turn and Lever	03																																																																																																																								
Turn Snib and Lever/ Knob	04																																																																																																																								
Lever/ Knob Only	05																																																																																																																								
Turn Snib Only	06																																																																																																																								
Plain Plate	07																																																																																																																								
Cylinder and Fixed Lever/ Knob	08																																																																																																																								
Fixed Lever/ Knob Only	09																																																																																																																								
Privacy Indicator Emergency Turn Only	13																																																																																																																								
Privacy Indicator Emergency Turn and Lever/ Knob	14																																																																																																																								
Privacy Indicator Turn Snib Only	15																																																																																																																								
Privacy Indicator Turn Snib and Lever/ Knob	16																																																																																																																								
Cylinder, Lever/ Knob and LED	20																																																																																																																								
Cylinder, Fixed Lever/ Knob and LED	21																																																																																																																								
Lever/ Knob and LED	22																																																																																																																								
Cylinder and LED	23																																																																																																																								
Pull Handle Only	24																																																																																																																								
Pull Handle and Cylinder	25																																																																																																																								
Pull Handle and Emergency Turn	26																																																																																																																								
Pull Handle and Turn Snib	27																																																																																																																								
Pull Handle and Privacy Indicator Emergency Turn	28																																																																																																																								
Pull Handle and Privacy Indicator Turn Snib	29																																																																																																																								
Flush Pull Only	31																																																																																																																								
Flush Pull and Cylinder	32																																																																																																																								
Flush Pull and Emergency Turn	33																																																																																																																								
Flush Pull and Turn Snib	34																																																																																																																								
Engraving Options	Price																																																																																																																								
Flush Pull and Privacy Indicator Emergency Turn	35																																																																																																																								
Flush Pull and Privacy Indicator Turn Snib	36																																																																																																																								
Pull Handle and Knob/ Lever	56																																																																																																																								
Pull Handle, Cylinder and Knob/ Lever	57																																																																																																																								
Pull Handle, Emergency Turn and Knob/ Lever	58																																																																																																																								
Pull Handle, Turn Snib and Knob/ Lever	59																																																																																																																								
Pull Handle, Privacy Indicator Emergency Turn and Knob/ Lever	60																																																																																																																								
Pull Handle, Privacy Indicator Turn Snib and Knob/ Lever	61																																																																																																																								
Flush Pull and Lever/ Knob	62																																																																																																																								
Flush Pull and Cylinder and Lever/ Knob	63																																																																																																																								
Flush Pull and Emergency Turn and Lever/ Knob	64																																																																																																																								
Flush Pull and Turn Snib and Lever/ Knob	65																																																																																																																								
Flush Pull and Privacy Indicator Emergency Turn and Lever/ Knob	66																																																																																																																								
Flush Pull and Privacy Indicator Turn Snib and Knob/ Lever	67																																																																																																																								
Lever/ Knob	Price																																																																																																																								
Standard Knob	21																																																																																																																								
Webbed Knob	22																																																																																																																								
Lever	23																																																																																																																								
Handing	Price																																																																																																																								
Left Handed	L																																																																																																																								
Right Handed	R																																																																																																																								
Finish	Price																																																																																																																								
Satin Stainless Steel	SS																																																																																																																								

Engraving Options	Price
Male Symbol	A R
Male Text	B S
Female Symbol	C T
Female Text	D U
Disabled Symbol	E V
Push Text	F W
Pull Text	G X
Unisex Symbol	H Y
No Option	N
Miscellaneous Text*	P
Corporate Engraving**	Q

*Separate charge per letter
**Separate charge per logo
For all in-filled engraving, black gloss is the standard.
A-G Outlined Infill
R-X Full Infill

Cylinder Options	Price
Australian Oval	A
No Cylinder	N

Note: Cylinder guards must be ordered with all cylinder function plates. All turn snib functions are supplied with tailbars and clutching mechanisms as standard. For no tailbar and clutching insert 'N' after function number e.g. 220D06NNNLSS

Plate Door Furniture

Palladium® Series Overview

The exceptional range of Palladium Door Furniture offers builders, specifiers and interior designers an array of levers that can be used in any residential environment.

The Palladium Series of door furniture reflects the best in quality, blended with sophisticated designs. The Palladium Series was produced to meet the rigorous aesthetic requirements of residential markets, while conforming to the ever increasing need for quality semi-commercial building segments.

Available in Palladium and Palladium Xtra versions to suit a wide range of applications.



Summit® L1



Spire® L2



Element™ L3



Glide™ L4



Aria® #27



Hakea® #28



Acacia® #29



Saltbush® #34



Mulga® #36



Gidgee® #37

Plate Door Furniture

Palladium® Series Door Furniture



The Palladium Series represents the highest standard in residential and semi-commercial door hardware and is brought to you through modern innovative designs, combined with quality manufacturing. A wide range of lever options is available to enable a common style throughout the home.

Features and Specifications

Dimensions

222 x 31 x 9mm

Handing

Easy, field selectable handing.

Materials

All plates and levers in the Palladium Series are constructed from solid zinc die-cast.

Fixing

Lockwood Palladium Series Door Furniture is a complete set, supplied with both the internal and external plates. Plates are designed to fit back to back to be fully concealed externally.

Door Thickness

Minimum 32mm – maximum 45mm door thickness.

Keying

Use with Euro profile cylinder.

Finishes

Satin Chrome Pearl	SP
Chrome Plate	CP
Gold Plate	GLD
White	WH
Black	BLK
Primrose	PRM
Magnolia	MAG
Polyester Powdercoat	PPC

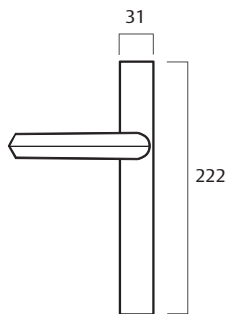

48.5mm Plates and Functions

For use with Defender Mortice Locks.

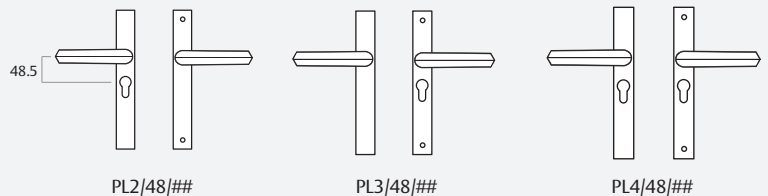

85mm Plates and Functions

For use with Optimum Mortice Locks.

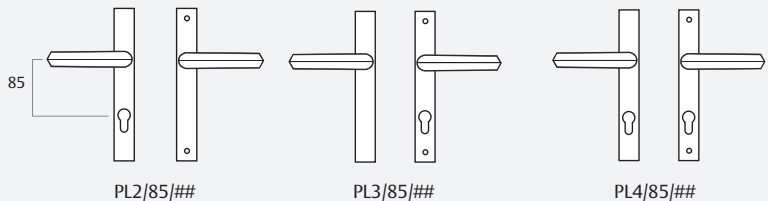

Note: The internal single cylinder configuration is also used in the Palladium French Door kits (PLFD/85/##) only in this configuration the external lever is fixed.

No Pitch Plates

For use with passage functions.

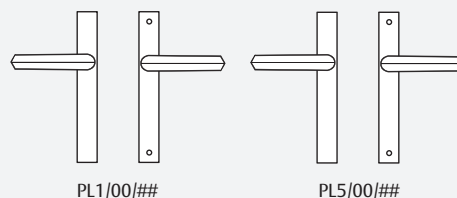

Represents lever style number.

Plate Door Furniture

Palladium® Xtra Furniture

The Palladium Xtra Series is designed specifically for the Optimum range of mortice locks to increase functionality enabling both internal snibbing for safety mode and lock status indication.

Palladium Xtra is suitable for use in residential buildings, apartments and semi-commercial applications.

Features and Specifications

Dimensions

222 x 31 x 9mm

Handing

Easy, field selectable handing.

Materials

All plates and levers in the Palladium Series are constructed from solid zinc die-cast.

Fixing

Lockwood Palladium Xtra door furniture is a complete set, supplied with both the internal and external plates. Plates are designed to fit back to back to be fully concealed externally.

Door Thickness

Minimum 32mm – maximum 45mm door thickness.

Keying

Use with Euro profile cylinder.

Finishes

Satin Chrome Pearl	SP
Black	BLK



85mm Plates and Functions

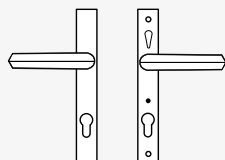

PL4/85/##

Represents lever style number.

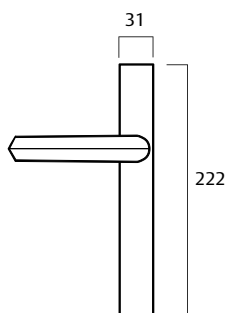
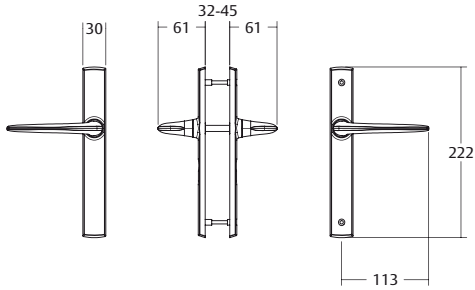

Plate Door Furniture

Palladium® Series Door Furniture

Summit® L1



Hakea® #28

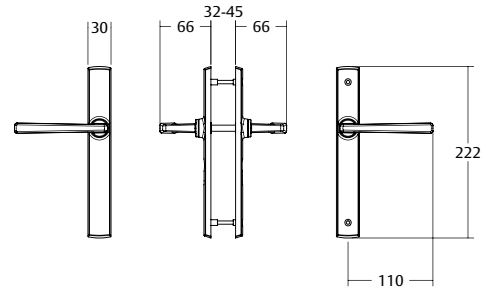

Spire® L2

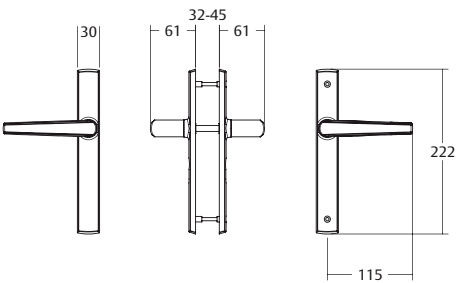

Acacia® #29

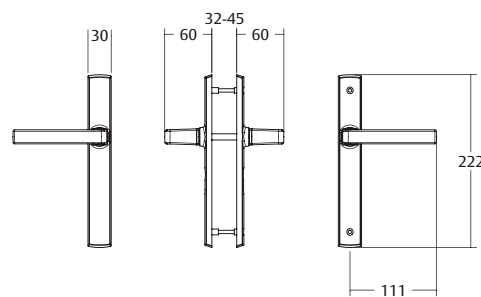

Element™ L3

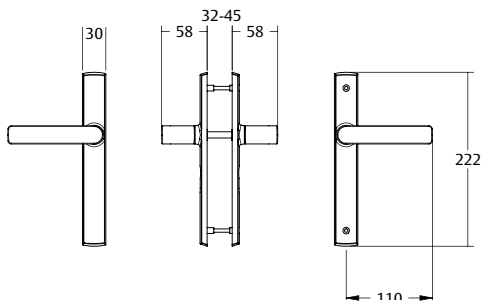

Saltbush® #34

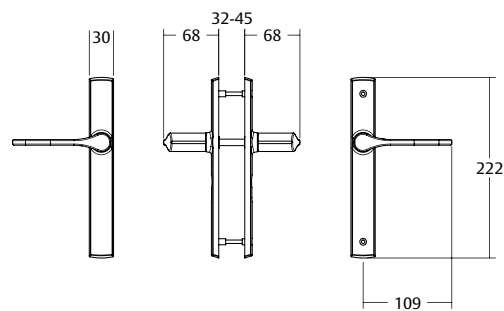

Glide™ L4

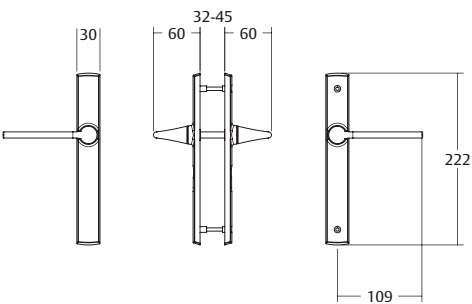

Mulga® #36

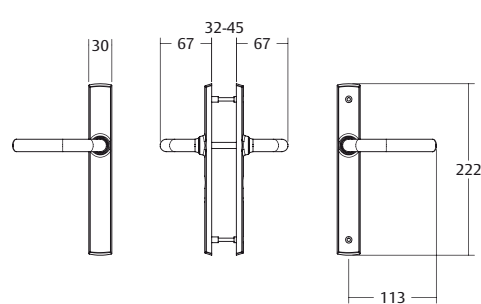

Aria® #27

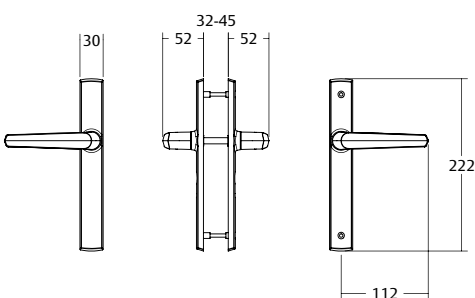

Gidgee® #37

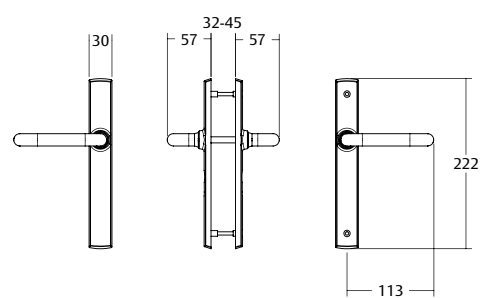

Plate Door Furniture

Palladium® Series Ordering Procedure

Ordering Procedure

Sample part number PL4/85/34SC is made up of several sections.
Choose your product by selecting an option from each section.

For example:

Palladium

Platform Name	Function	Pitch	Lever	Finish
PL	4	85	34	SP

Platform Name	Pitch	Finish
Palladium PL	Lever Only 00	Chrome Plate CP
	48.5mm Pitch 48	Gold Plate GLD
	85mm Pitch 85	Satin Chrome Pearl SP
Function	Lever	White WH
Passage Set 1	Summit L1	Black BLK
External Single Cylinder 2	Spire L2	Primrose PRM
Internal Single Cylinder 3	Element L3	Magnolia MAG
Double Cylinder 4	Glide L4	Other Powdercoat PPC
Fixed Dummy 5	Aria 27	
French Door FD	Hakea 28	
	Acacia 29	
	Saltbush 34	
	Mulga 36	
	Gidgee 37	

Palladium Xtra

Platform Name	Function	Pitch	Lever	Finish
PX	4	85	34	SP

Platform Name	Pitch	Finish
Palladium Xtra PX	85mm Pitch 85	Satin Chrome Pearl SP
		Black BLK
Function	Lever	
Double Cylinder 4	Aria 27	

ASSA ABLOY is the global leader in door opening solutions, dedicated to satisfying end-user needs for security, safety and convenience



Lockwood is the leading brand in the Australian locking industry. With an established reputation for high quality products, this iconic brand provides a wide range of locking solutions to residential housing, commercial building and industrial application markets. Lockwood is supported by an extensive distribution and after-sales support network. Our customers include retailers, architects, trade and industrial personnel, locksmiths and security dealers.

ASSA ABLOY

ASSA ABLOY is the global leader in door opening solutions, dedicated to satisfying end-user needs for security, safety and convenience.

ASSA ABLOY is represented in all major regions, in both mature and emerging markets, with leading positions in Australia, Europe and North America.

As the world's leading lock group, ASSA ABLOY offers a more complete product range of door opening solutions than any other company in the market.

Australia
1300 LOCK UP (1300 562 587)
lockweb.com.au

New Zealand
+64 9415 7111
assaabloy.co.nz

ASSA ABLOY Australia Pty Ltd
235 Huntingdale Road
Oakleigh, Victoria, 3166
Australia

info.au@assaabloy.com
assaabloy.com.au

ASSA ABLOY New Zealand Ltd
6 Armstrong Road
Albany, North Shore City, 0632
New Zealand

info.nz@assaabloy.com
assaabloy.co.nz

