

AIRFIT 600

Active Chilled Beams



Index

Subject	Page
Index	1
Introduction	2
General description	3-4
Product features	5-6
Dimensions	7
Performance data	8-11
Selection example	12
Guide specifications	13

Introduction

The Barcol-Air chilled beam systems are designed to achieve a comfortable indoor climate with low energy consumption and a low ceiling void height. The systems provide cooling, heating, ventilation and humidity control with low noise and minimal maintenance.



Figure 1: AIRFIT Active Chilled Beam

System Technology

Barcol-Air active chilled beams integrate the primary air distribution function with the secondary air heat exchange using a proprietary air nozzle technology to induce secondary room air into the unit and through the heat exchanger before mixing with the primary air. The resulting mixture of primary air and induced secondary room air is then supplied to the room through the contoured diffusers which are designed to keep the air close to the ceiling using the Coanda effect.

Barcol-Air's AIRFIT 600 series active chilled beams units are designed with a nominal width of 600 mm to integrate with the ceiling grids of the more popular ceiling configurations. Standard unit lengths are nominally 1,200 mm to 3,000 mm in 300 mm increments but special lengths are also available to match with specific ceiling requirements.

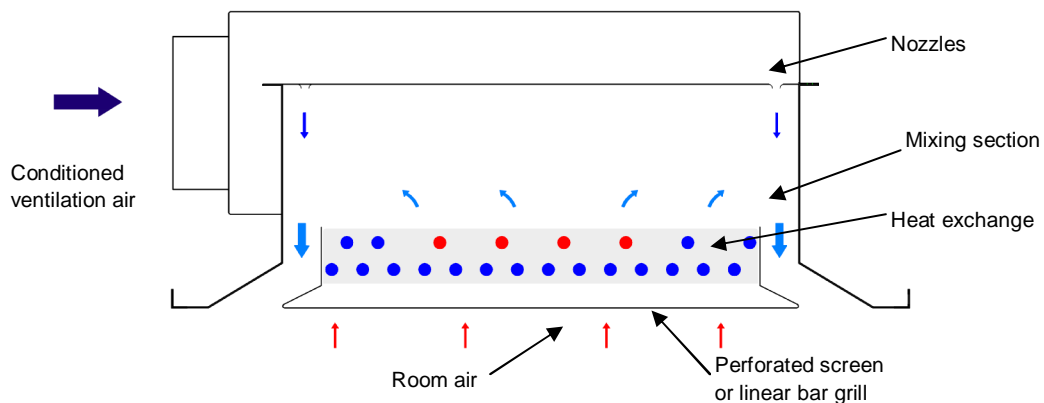

Figure 3: Operating Principle of the Active Chilled Beam

System Concept

The principle of the active chilled beam system is to use terminal chilled water heat exchangers in the ceiling to offset the room sensible cooling loads or to provide sensible heating. The ventilation and humidity control requirements are taken care of using a separate primary conditioned air supplied by a central air handling unit.

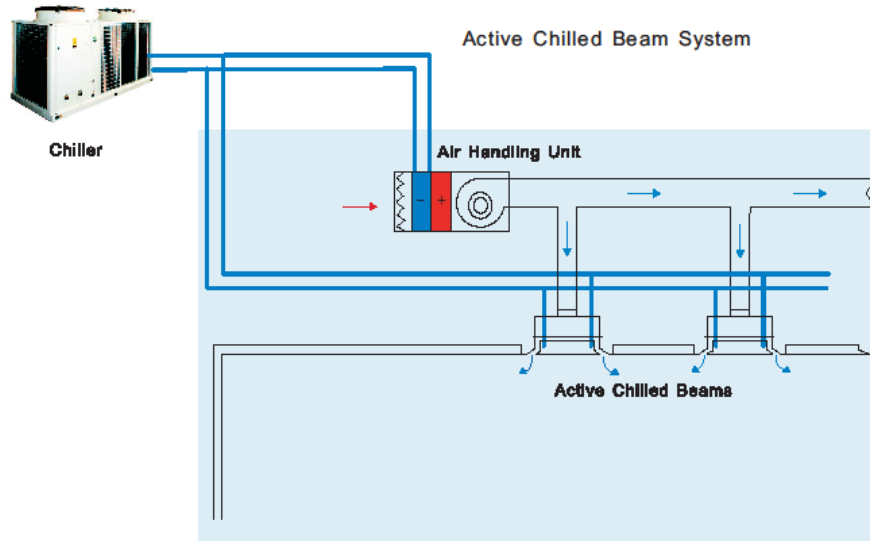

Figure 2: Active Chilled Beam System

Due to the relatively high supply chilled water temperatures, about 15 deg C, the heat exchangers operate dry avoiding many of the maintenance and health concerns that are associated with other systems that use terminal heat exchangers such as fan coil units.

The system provides large energy savings because the amount of air to be circulated around the building can be reduced to close to that required for ventilation and humidity control only resulting in large reductions in air handling unit fan power and energy consumption.

Further energy savings result from the use of high chilled water temperatures serving the heat exchangers. This can allow the water chiller to operate at higher water temperatures improving chiller operating efficiency and energy consumption.

Air distribution

The specific shape of the supply slot diffusers creates two opposing discharge air flows from the active chilled beam along the suspended ceiling. The velocity of the supply air along the suspended ceiling creates the Coanda-effect whereby velocity differences in the cool air stream press the air stream against the suspended ceiling, thereby extending the air throw and preventing the cool air from dropping into the comfort zone prematurely. It is important, with such air patterns, that the suspended ceiling is flat and free of any obstacles, especially light fixtures situated close to the slots, because these can disturb the Coanda-effect.

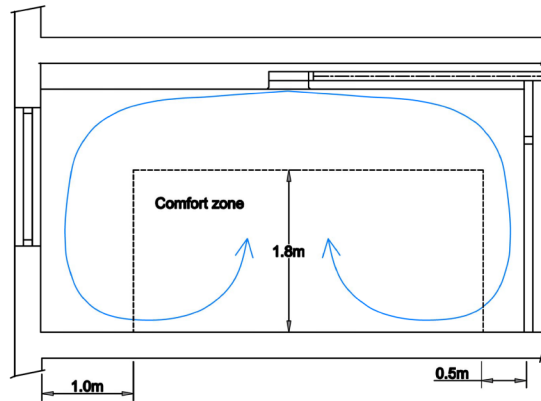

Figure 4: AIRFIT – Air Distribution

Facade-orientation

Orientation of the active chilled beam with regard to the facade has no influence on the operation. There are two common installation arrangements, perpendicular or parallel to the facade. The choice between perpendicular and parallel will be determined by:

- Aesthetics (fitting into the pattern of the suspended ceiling).
- Level of flexibility to create offices within the floor plan
- Number of active chilled beams required
- Available distance for the air throw. The air must have the opportunity to mix with the room air before impinging on a wall or an opposing air stream from another chilled beam.
- Disturbances in the suspended ceiling which might influence air pattern, like lighting fixtures.
- Disturbances in the facade or floor, like radiators or floor convectors that could influence the air pattern.

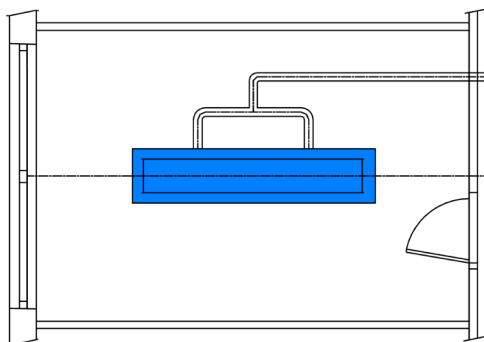

Figure 5: Perpendicular to Facade

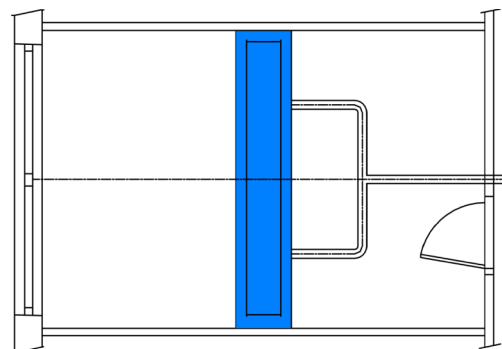

Figure 6: Parallel to Facade

Product Features

High capacity with multi choice nozzles

The AIRFIT 600 series active chilled beams have available a choice of 8 nozzle configurations designed to provide high induction rates for the secondary room air and thereby high cooling and heating capacities. This makes them suitable for applications in building perimeter zones with higher loads as well as internal building zones. Nozzles are factory installed and can be blanked if one side discharge is required.



Figure 7: High Efficiency Air Nozzles

Low Height:

The AIRFIT 600 series has a maximum height of 242 mm allowing the use of reduced height ceiling voids to maximize ceiling heights. Alternatively the building slab to slab height can be reduced allowing more floors in a given building height.

Flexible Sizes

Units are available with lengths between 1200 mm and 3000 mm to match with most ceiling configurations. Unit lengths can also be tailored to match exact installation requirement.

Aesthetic Choices

The AIRFIT series can be supplied with perforated return air diffusers or linear slot diffusers to match the aesthetic requirements of the building. Exposed metal surfaces are powder painted. The standard finish colour is RAL 9010 with 20% gloss. Other RAL colours can be supplied to match project requirements. Units can also be supplied with perforated centre diffusers or alternatively diffusers with linear blades



Figure 8: Perforated Diffuser



Figure 9: Linear Blade Diffuser

Simple mounting:

Units can be easily suspended from the concrete slab above using threaded rod or hanging wire support systems to match with metal panel, fiber board or plaster ceilings. Units can also be installed without false ceilings.

Low noise:

The efficiently shaped nozzles create maximum induction at a minimum sound level

Low maintenance:

The AIRFIT 600 series active chilled beam has no filter, fan, drain pan or any other moving parts and maintenance is limited to cleaning the exposed metal surfaces and cleaning any dust from the heat exchanger every 2 to 5 years depending on the cleanliness of the supply air. The heat exchanger can be easily accessed by dropping down the centre perforated diffuser which is equipped with a safety hanging wires, and then removing any dust with a vacuum cleaner.

Controls:

The active chilled beam can be supplied with constant air volume controllers for the primary air, water control valves with room control sensors as well as balancing and isolation valves and condensation sensors.

Air Distribution Control (Optional)

To allow selection of the air discharge pattern AIRFIT 600 series units can be supplied with optional air discharge deflectors. These air deflectors can be independently adjusted to provide any air distribution pattern.

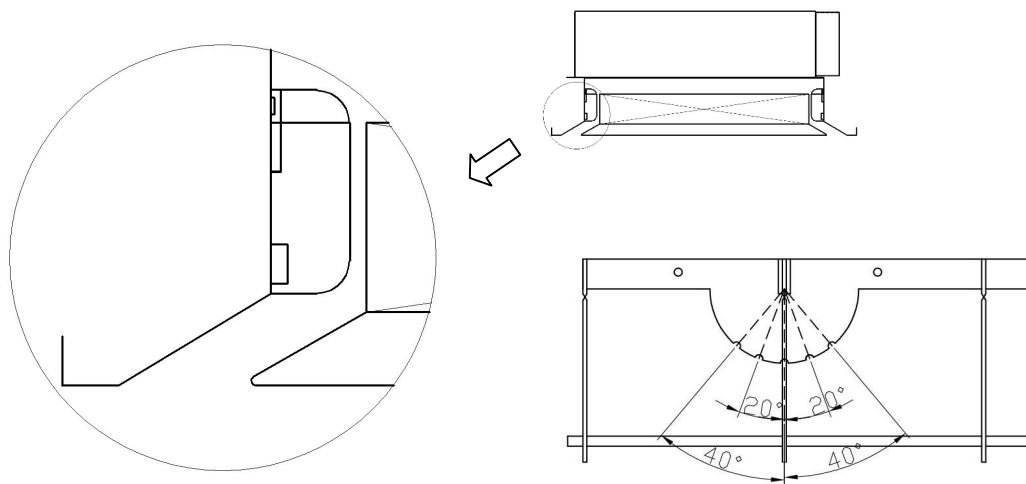
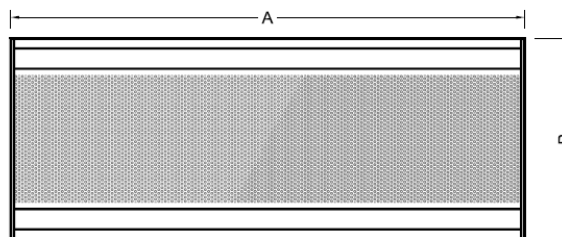
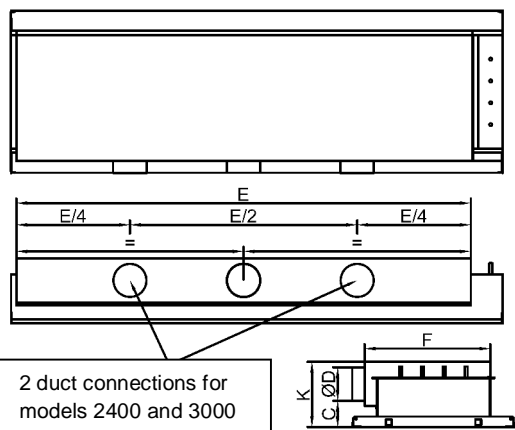

Figure 10 : Air Distribution Control

Dimensions AIRFIT 600

Duct connection on the side



Duct connection on top

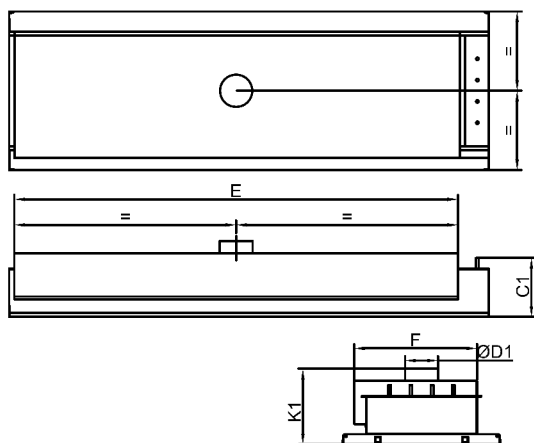

Water Connection Diameters in mm

Unit Size	1200-1800	2400-3000
Chilled water	12	15
Hot water	12	12

Table1 Dimensional data AIRFIT 600

Size	1200	1500	1800	2400	3000
A	1195	1495	1795	2395	2995
B	595	595	595	595	595
C	96	96	96	96	96
C1	221	221	221	221	221
D	1x ø123	1x ø123	1x ø123	2x ø123	2x ø123
D1	1x ø123	1x ø123	1x ø123	1 x ø158	1 x ø198
E	1064	1364	1664	2264	2864
F	460	460	460	460	460
K	242	242	242	242	240
K1	285	285	285	285	285
Weight(kg)	25	30	34	44	54

1. Dimensions in mm.
2. On request, Barcol -Air can provide air connectors on the short side of the plenum.
3. Intermediate lengths are available upon request.

Performance Data AIRFIT 600

AIRFIT 600- 1200							Cooling Troom minus T entering water temperature = 10 deg C												Heating T entering water temperature minus T room = 35 deg C											
Model	Nozzle	Primary Airflow L/s	Plenum Pressure Pa	Sound Pressure Level dB(A)	Sound Pressure Level NC	Air Cooling Capacity ΔT=10C W	Cooling Water Flow 1				Cooling Water Flow 2				Cooling Water Flow 3				Heating Water Flow 1				Heating Water Flow 2				Heating Water Flow 3			
							Water flow l/s	Water ΔP Kpa	Water Cooling Capacity W	ΔT Water deg C	Water flow l/s	Water ΔP Kpa	Water Cooling Capacity W	ΔT Water deg C	Water flow l/s	Water ΔP Kpa	Water Cooling Capacity W	ΔT Water deg C	Water flow l/s	Water ΔP Kpa	Water Heating Capacity W	ΔT Water deg C	Water flow l/s	Water ΔP Kpa	Water Heating Capacity W	ΔT Water deg C	Water flow l/s	Water ΔP Kpa	Water Heating Capacity W	ΔT Water deg C
1200	A0	6	36	≤15	≤15	73	0.04	3.5	380	2.3	0.06	7.9	440	1.8	0.08	14.0	470	1.4	0.02	1.5	680	8.1	0.03	3.5	860	6.8	0.04	6.1	940	5.6
		8	64	≤15	≤15	97	0.04	3.5	480	2.9	0.06	7.9	540	2.1	0.08	14.0	580	1.7	0.02	1.5	900	10.7	0.03	3.5	1140	9.1	0.04	6.1	1260	7.5
		10	100	≤15	≤15	121	0.04	3.5	550	3.3	0.06	7.9	630	2.5	0.08	14.0	670	2.0	0.02	1.5	1080	12.9	0.03	3.5	1370	10.9	0.04	6.1	1500	9.0
		12	144	≤15	≤15	146	0.04	3.5	600	3.6	0.06	7.9	690	2.7	0.08	14.0	740	2.2	0.02	1.5	1230	14.7	0.03	3.5	1550	12.3	0.04	6.1	1710	10.2
1200	A1	14	196	≤15	≤15	170	0.04	3.5	650	3.9	0.06	7.9	750	3.0	0.08	14.0	800	2.4	0.02	1.5	1350	16.1	0.03	3.5	1710	13.6	0.04	6.1	1880	11.2
		8	42	≤15	≤15	97	0.04	3.5	420	2.5	0.06	7.9	480	1.9	0.08	14.0	510	1.5	0.02	1.5	850	10.2	0.03	3.5	1070	8.5	0.04	6.1	1180	7.0
		10	66	≤15	≤15	121	0.04	3.5	510	3.0	0.06	7.9	580	2.3	0.08	14.0	620	1.9	0.02	1.5	1020	12.2	0.03	3.5	1290	10.3	0.04	6.1	1420	8.5
		12	95	≤15	≤15	146	0.04	3.5	580	3.5	0.06	7.9	670	2.7	0.08	14.0	710	2.1	0.02	1.5	1170	14.0	0.03	3.5	1480	11.8	0.04	6.1	1620	9.7
1200	B1	14	129	≤15	≤15	170	0.04	3.5	640	3.8	0.06	7.9	740	2.9	0.08	14.0	780	2.3	0.02	1.5	1290	15.4	0.03	3.5	1630	13.0	0.04	6.1	1790	10.7
		16	169	≤15	≤15	194	0.04	3.5	700	4.2	0.06	7.9	800	3.2	0.08	14.0	850	2.5	0.02	1.5	1400	16.7	0.03	3.5	1770	14.1	0.04	6.1	1940	11.6
		12	47	≤15	≤15	146	0.04	3.5	450	2.7	0.06	7.9	520	2.1	0.08	14.0	550	1.6	0.02	1.5	930	11.1	0.03	3.5	1180	9.4	0.04	6.1	1290	7.7
		15	73	≤15	≤15	182	0.04	3.5	530	3.2	0.06	7.9	610	2.4	0.08	14.0	650	1.9	0.02	1.5	1070	12.8	0.03	3.5	1360	10.8	0.04	6.1	1500	9.0
1200	C1	18	105	≤15	≤15	218	0.04	3.5	600	3.6	0.06	7.9	690	2.7	0.08	14.0	740	2.2	0.02	1.5	1200	14.3	0.03	3.5	1520	12.1	0.04	6.1	1670	10.0
		21	143	≤15	≤15	255	0.04	3.5	660	3.9	0.06	7.9	760	3.0	0.08	14.0	810	2.4	0.02	1.5	1310	15.6	0.03	3.5	1650	13.1	0.04	6.1	1820	10.9
		24	186	≤15	≤15	291	0.04	3.5	710	4.2	0.06	7.9	820	3.3	0.08	14.0	870	2.6	0.02	1.5	1400	16.7	0.03	3.5	1770	14.1	0.04	6.1	1950	11.6
		18	57	≤15	≤15	218	0.04	3.5	520	3.1	0.06	7.9	590	2.3	0.08	14.0	630	1.9	0.02	1.5	980	11.7	0.03	3.5	1240	9.9	0.04	6.1	1360	8.1
1200	E1	22	85	≤15	≤15	267	0.04	3.5	580	3.5	0.06	7.9	670	2.7	0.08	14.0	710	2.1	0.02	1.5	1090	13.0	0.03	3.5	1380	11.0	0.04	6.1	1520	9.1
		26	119	≤15	≤15	315	0.04	3.5	640	3.8	0.06	7.9	730	2.9	0.08	14.0	780	2.3	0.02	1.5	1200	14.3	0.03	3.5	1520	12.1	0.04	6.1	1670	10.0
		30	158	≤15	≤15	364	0.04	3.5	690	4.1	0.06	7.9	790	3.1	0.08	14.0	840	2.5	0.02	1.5	1300	15.5	0.03	3.5	1640	13.1	0.04	6.1	1810	10.8
		34	203	≤15	≤15	412	0.04	3.5	730	4.4	0.06	7.9	840	3.3	0.08	14.0	890	2.7	0.02	1.5	1380	16.5	0.03	3.5	1750	13.9	0.04	6.1	1930	11.5
1200	F1	24	58	≤15	≤15	291	0.04	3.5	560	3.3	0.06	7.9	640	2.5	0.08	14.0	680	2.0	0.02	1.5	1070	12.8	0.03	3.5	1350	10.7	0.04	6.1	1490	8.9
		28	79	≤15	≤15	340	0.04	3.5	610	3.6	0.06	7.9	700	2.8	0.08	14.0	740	2.2	0.02	1.5	1170	14.0	0.03	3.5	1480	11.8	0.04	6.1	1620	9.7
		32	103	≤15	≤15	388	0.04	3.5	650	3.9	0.06	7.9	750	3.0	0.08	14.0	790	2.4	0.02	1.5	1250	14.9	0.03	3.5	1590	12.7	0.04	6.1	1740	10.4
		36	130	≤15	≤15	437	0.04	3.5	690	4.1	0.06	7.9	790	3.1	0.08	14.0	840	2.5	0.02	1.5	1330	15.9	0.03	3.5	1680	13.4	0.04	6.1	1850	11.0
1200	G1	40	160	≤15	≤15	485	0.04	3.5	720	4.3	0.06	7.9	830	3.3	0.08	14.0	880	2.6	0.02	1.5	1400	16.7	0.03	3.5	1770	14.1	0.04	6.1	1950	11.6
		28	50	≤15	≤15	340	0.04	3.5	560	3.3	0.06	7.9	640	2.5	0.08	14.0	680	2.0	0.02	1.5	1070	12.8	0.03	3.5	1360	10.8	0.04	6.1	1490	8.9
		33	70	≤15	≤15	400	0.04	3.5	610	3.6	0.06	7.9	700	2.8	0.08	14.0	740	2.2	0.02	1.5	1170	14.0	0.03	3.5	1480	11.8	0.04	6.1	1630	9.7
		38	93	≤15	≤15	461	0.04	3.5	650	3.9	0.06	7.9	750	3.0	0.08	14.0	790	2.4	0.02	1.5	1260	15.0	0.03	3.5	1590	12.7	0.04	6.1	1750	10.4
1200	H1	43	119	≤15	≤15	522	0.04	3.5	690	4.1	0.06	7.9	790	3.1	0.08	14.0	840	2.5	0.02	1.5	1330	15.9	0.03	3.5	1690	13.5	0.04	6.1	1860	11.1
		48	148	≤15	≤15	582	0.04	3.5	720	4.3	0.06	7.9	830	3.3	0.08	14.0	880	2.6	0.02	1.5	1400	16.7	0.03	3.5	1770	14.1	0.04	6.1	1950	11.6
		32	52	≤15	≤15	388	0.04	3.5	560	3.3	0.06	7.9	640	2.5	0.08	14.0	680	2.0	0.02	1.5	1100	13.1	0.03	3.5	1400	11.1	0.04	6.1	1540	9.2
		38	73	≤15	≤15	461	0.04	3.5	620	3.7	0.06	7.9	710	2.8	0.08	14.0	750	2.2	0.02	1.5	1180	14.1	0.03	3.5	1500	11.9	0.04	6.1	1650	9.9
1200	H1	44	97	≤15	≤15	534	0.04	3.5	660	3.9	0.06	7.9	760	3.0	0.08	14.0	810	2.4	0.02	1.5	1250	14.9	0.03	3.5	1590	12.7	0.04	6.1	1740	10.4
		50	126	≤15	≤15	607	0.04	3.5	700	4.2	0.06	7.9	810	3.2	0.08	14.0	860	2.6	0.02	1.5	1320	15.8	0.03	3.5	1660	13.2	0.04	6.1	1830	10.8
		56	158	≤15	≤15	679	0.04	3.5	740	4.4	0.06	7.9	850	3.4	0.08	14.0	900	2.7	0.02	1.5	1370	16.4	0.03	3.5	1740	13.9	0.04	6.1	1910	11.4
		44	47	≤15	≤15	534	0.04	3.5	640	3.8	0.06	7.9	730	2.9	0.08	14.0	780	2.3	0.02	1.5	1170	14.0	0.03	3.5	1480	11.8	0.04	6.1	1620	9.7
1200	H1	52	66	≤15	≤15	631	0.04	3.5	680	4.1	0.06	7.9	780	3.1	0.08	14.0	820	2.4	0.02	1.5	1240	14.8	0.03	3.5	1570	12.5	0.04	6.1	1720	10.3
		60	88	≤15	≤15	728	0.04	3.5	710	4.2	0.06	7.9	810	3.2	0.08	14.0	860	2.6	0.02	1.5	1300	15.5	0.03	3.5	1650	13.1	0.04	6.1	1810	10.8
		68	113	≤15	≤15	825	0.04	3.5	730	4.4	0.06	7.9	840	3.3	0.08	14.0	890	2.7	0.02	1.5	1350	16.1	0.03	3.5	1710	13.6	0.04	6.1	1890	11.3
		76	142	≤15	≤15	922	0.04	3.5	760	4.5	0.06	7.9	870	3.5	0.08	14.0	920	2.7	0.02	1.5	1400	16.7	0.03	3.5	1780	14.2	0.04	6.1	1950	11.6

Performance table notes

- 1) Air cooling capacities are based on Troom minus T primary air = 10 deg C. For other conditions multiply the table air cooling capacity by the required (Troom minus Tprimary air) divided by 10. Alternatively the air cooling capacity can be calculated from the formula: Air cooling capacity W = 1.213 x Airflow (l/s) x (Troom minus T primary air)
- 2) Water cooling capacities are based on Troom minus T entering water temperature = 10 deg C. For other conditions multiply the table water cooling capacity by the required (Troom minus T entering water) divided by 10.
- 3) Water heating capacities are based on 4 pipe chilled beams with T room minus T entering water temperature = 35 deg C. For other conditions multiply the table water

Performance Data AIRFIT 600

AIRFIT 600- 1800							Cooling Troom minus T entering water temperature = 10 deg C												Heating T entering water temperature minus T room = 35 deg C											
Model	Nozzle	Primary Airflow L/s	Plenum Pressure Pa	Sound Pressure Level dB(A)	Sound Pressure Level NC	Air Cooling Capacity ΔT=10C W	Cooling Water Flow 1				Cooling Water Flow 2				Cooling Water Flow 3				Heating Water Flow 1				Heating Water Flow 2				Heating Water Flow 3			
							Water flow l/s	Water ΔP Kpa	Water Cooling Capacity W	ΔT Water deg C	Water flow l/s	Water ΔP Kpa	Water Cooling Capacity W	ΔT Water deg C	Water flow l/s	Water ΔP Kpa	Water Cooling Capacity W	ΔT Water deg C	Water flow l/s	Water ΔP Kpa	Water Heating Capacity W	ΔT Water deg C	Water flow l/s	Water ΔP Kpa	Water Heating Capacity W	ΔT Water deg C	Water flow l/s	Water ΔP Kpa	Water Heating Capacity W	ΔT Water deg C
1800	A0	10	40	≤15	≤15	121	0.04	4.8	580	3.5	0.06	10.8	670	2.7	0.08	19.3	710	2.1	0.03	4.4	1070	8.5	0.04	7.8	1350	8.1	0.05	12.1	1490	7.1
		13	68	≤15	≤15	158	0.04	4.8	710	4.2	0.06	10.8	810	3.2	0.08	19.3	860	2.6	0.03	4.4	1420	11.3	0.04	7.8	1800	10.7	0.05	12.1	1990	9.5
		16	103	20	≤15	194	0.04	4.8	800	4.8	0.06	10.8	920	3.7	0.08	19.3	980	2.9	0.03	4.4	1700	13.5	0.04	7.8	2150	12.8	0.05	12.1	2370	11.3
		19	145	26	21	230	0.04	4.8	880	5.3	0.06	10.8	1010	4.0	0.08	19.3	1070	3.2	0.03	4.4	1930	15.4	0.04	7.8	2450	14.6	0.05	12.1	2690	12.8
		22	195	29	24	267	0.04	4.8	950	5.7	0.06	10.8	1090	4.3	0.08	19.3	1160	3.5	0.03	4.4	2130	17.0	0.04	7.8	2690	16.1	0.05	12.1	2960	14.1
1800	A1	13	45	≤15	≤15	158	0.04	4.8	620	3.7	0.06	10.8	710	2.8	0.08	19.3	760	2.3	0.03	4.4	1330	10.6	0.04	7.8	1690	10.1	0.05	12.1	1860	8.9
		16	68	18	≤15	194	0.04	4.8	750	4.5	0.06	10.8	860	3.4	0.08	19.3	910	2.7	0.03	4.4	1610	12.8	0.04	7.8	2040	12.2	0.05	12.1	2240	10.7
		19	96	23	18	230	0.04	4.8	850	5.1	0.06	10.8	970	3.9	0.08	19.3	1030	3.1	0.03	4.4	1840	14.6	0.04	7.8	2330	13.9	0.05	12.1	2560	12.2
		22	129	27	22	267	0.04	4.8	930	5.6	0.06	10.8	1070	4.3	0.08	19.3	1140	3.4	0.03	4.4	2030	16.2	0.04	7.8	2570	15.3	0.05	12.1	2830	13.5
		25	166	31	26	303	0.04	4.8	1010	6.0	0.06	10.8	1160	4.6	0.08	19.3	1230	3.7	0.03	4.4	2200	17.5	0.04	7.8	2790	16.7	0.05	12.1	3070	14.7
1800	B1	20	52	21	16	243	0.04	4.8	690	4.1	0.06	10.8	790	3.1	0.08	19.3	840	2.5	0.03	4.4	1460	11.6	0.04	7.8	1850	11.0	0.05	12.1	2040	9.7
		24	75	26	21	291	0.04	4.8	790	4.7	0.06	10.8	900	3.6	0.08	19.3	960	2.9	0.03	4.4	1690	13.5	0.04	7.8	2140	12.8	0.05	12.1	2360	11.3
		28	102	30	25	340	0.04	4.8	870	5.2	0.06	10.8	1000	4.0	0.08	19.3	1060	3.2	0.03	4.4	1890	15.0	0.04	7.8	2390	14.3	0.05	12.1	2630	12.6
		32	133	34	29	388	0.04	4.8	940	5.6	0.06	10.8	1080	4.3	0.08	19.3	1150	3.4	0.03	4.4	2060	16.4	0.04	7.8	2610	15.6	0.05	12.1	2870	13.7
		36	168	37	32	437	0.04	4.8	1010	6.0	0.06	10.8	1160	4.6	0.08	19.3	1230	3.7	0.03	4.4	2210	17.6	0.04	7.8	2790	16.7	0.05	12.1	3070	14.7
1800	C1	28	55	28	23	340	0.04	4.8	750	4.5	0.06	10.8	860	3.4	0.08	19.3	910	2.7	0.03	4.4	1520	12.3	0.04	7.8	1920	11.6	0.05	12.1	2110	10.3
		33	77	32	27	400	0.04	4.8	830	5.0	0.06	10.8	950	3.8	0.08	19.3	1010	3.0	0.03	4.4	1720	13.7	0.04	7.8	2180	13.0	0.05	12.1	2400	11.5
		38	102	36	31	461	0.04	4.8	900	5.4	0.06	10.8	1030	4.1	0.08	19.3	1090	3.3	0.03	4.4	1960	15.0	0.04	7.8	2400	14.3	0.05	12.1	2640	12.6
		43	131	39	34	522	0.04	4.8	960	5.7	0.06	10.8	1100	4.4	0.08	19.3	1160	3.5	0.03	4.4	2050	16.3	0.04	7.8	2590	15.5	0.05	12.1	2850	13.6
		48	163	41	36	582	0.04	4.8	1010	6.0	0.06	10.8	1160	4.6	0.08	19.3	1230	3.7	0.03	4.4	2180	17.4	0.04	7.8	2760	16.5	0.05	12.1	3040	14.5
1800	E1	38	58	34	29	461	0.04	4.8	810	4.8	0.06	10.8	930	3.7	0.08	19.3	990	3.0	0.03	4.4	1680	13.4	0.04	7.8	2130	12.7	0.05	12.1	2340	11.2
		44	78	38	33	534	0.04	4.8	880	5.3	0.06	10.8	1010	4.0	0.08	19.3	1070	3.2	0.03	4.4	1840	14.6	0.04	7.8	2330	13.9	0.05	12.1	2560	12.2
		50	101	40	35	607	0.04	4.8	940	5.6	0.06	10.8	1080	4.3	0.08	19.3	1150	3.4	0.03	4.4	1980	15.8	0.04	7.8	2500	14.9	0.05	12.1	2750	13.1
		56	126	44	39	679	0.04	4.8	1000	6.0	0.06	10.8	1140	4.5	0.08	19.3	1220	3.6	0.03	4.4	2100	16.7	0.04	7.8	2650	15.8	0.05	12.1	2920	13.9
		62	155	47	42	752	0.04	4.8	1050	6.3	0.06	10.8	1200	4.8	0.08	19.3	1270	3.8	0.03	4.4	2210	17.6	0.04	7.8	2790	16.7	0.05	12.1	3070	14.7
1800	F1	44	50	36	31	534	0.04	4.8	810	4.8	0.06	10.8	930	3.7	0.08	19.3	990	3.0	0.03	4.4	1690	13.5	0.04	7.8	2140	12.8	0.05	12.1	2360	11.3
		52	69	40	35	631	0.04	4.8	890	5.3	0.06	10.8	1020	4.1	0.08	19.3	1080	3.2	0.03	4.4	1850	14.7	0.04	7.8	2340	14.0	0.05	12.1	2580	12.3
		60	93	44	39	728	0.04	4.8	950	5.7	0.06	10.8	1090	4.3	0.08	19.3	1160	3.5	0.03	4.4	1990	15.8	0.04	7.8	2510	15.0	0.05	12.1	2760	13.2
		68	119	47	42	825	0.04	4.8	1000	6.0	0.06	10.8	1150	4.6	0.08	19.3	1220	3.6	0.03	4.4	2100	16.7	0.04	7.8	2660	15.9	0.05	12.1	2930	14.0
		76	148	50	45	922	0.04	4.8	1050	6.3	0.06	10.8	1210	4.8	0.08	19.3	1280	3.8	0.03	4.4	2210	17.6	0.04	7.8	2800	16.7	0.05	12.1	3080	14.7
1800	G1	54	59	40	35	655	0.04	4.8	850	5.1	0.06	10.8	970	3.9	0.08	19.3	1040	3.1	0.03	4.4	1740	13.9	0.04	7.8	2200	13.1	0.05	12.1	2420	11.6
		62	77	44	39	752	0.04	4.8	910	5.4	0.06	10.8	1050	4.2	0.08	19.3	1110	3.3	0.03	4.4	1870	14.9	0.04	7.8	2360	14.1	0.05	12.1	2600	12.4
		70	98	47	42	849	0.04	4.8	970	5.8	0.06	10.8	1110	4.4	0.08	19.3	1180	3.5	0.03	4.4	1980	15.8	0.04	7.8	2500	14.9	0.05	12.1	2750	13.1
		78	122	49	44	946	0.04	4.8	1020	6.1	0.06	10.8	1170	4.7	0.08	19.3	1240	3.7	0.03	4.4	2070	16.5	0.04	7.8	2630	15.7	0.05	12.1	2890	13.8
		86	149	51	46	1043	0.04	4.8	1060	6.3	0.06	10.8	1220	4.9	0.08	19.3	1300	3.9	0.03	4.4	2160	17.2	0.04	7.8	2740	16.4	0.05	12.1	3010	14.4
1800	H1	72	51	46	41	873	0.04	4.8	940	5.6	0.06	10.8	1080	4.3	0.08	19.3	1150	3.4	0.03	4.4	1840	14.6	0.04	7.8	2330	13.9	0.05	12.1	2560	12.2
		84	69	48	43	1019	0.04	4.8	990	5.9	0.06	10.8	1140	4.5	0.08	19.3	1210	3.6	0.03	4.4	1950	15.5	0.04	7.8	2470	14.7	0.05	12.1	2720	13.0
		96	90	51	46	1164	0.04	4.8	1030	6.1	0.06	10.8	1190	4.7	0.08	19.3	1260	3.8	0.03	4.4	2050	16.3	0.04	7.8	2590	15.5	0.05	12.1	2850	13.6
		108	114	53	48	1310	0.04	4.8	1070	6.4	0.06	10.8	1230	4.9	0.08	19.3	1300	3.9	0.03	4.4	2140	17.0	0.04	7.8	2700	16.1	0.05	12.1	2970	14.2
		120	141	56	51	1456	0.04	4.8	1100	6.6	0.06	10.8	1260	5.0	0.08	19.3	1340	4.0	0.03	4.4	2210	17.6	0.04	7.8	2800	16.7	0.05	12.1	3080	14.7

Performance table notes

- 1) Air cooling capacities are based on Troom minus T primary air = 10 deg C. For other conditions multiply the table air cooling capacity by the required (Troom minus Tprimary air) divided by 10. Alternatively the air cooling capacity can be calculated from the formula: Air cooling capacity W = 1.213 x Airflow (l/s) x (Troom minus T primary air)
- 2) Water cooling capacities are based on Troom minus T entering water temperature = 10 deg C. For other conditions multiply the table water cooling capacity by the required (Troom minus T entering water) divided by 10.
- 3) Water heating capacities are based on a pipe chilled beams with T room minus T entering water

Performance Data AIRFIT 600

AIRFIT 600- 2400							Cooling Troom minus T entering water temperature = 10 deg C												Heating T entering water temperature minus T room = 35 deg C											
Model	Nozzle	Primary Airflow L/s	Plenum Pressure Pa	Sound Pressure Level dB(A)	Sound Pressure Level NC	Air Cooling Capacity ΔT=10C W	Cooling Water Flow 1				Cooling Water Flow 2				Cooling Water Flow 3				Heating Water Flow 1				Heating Water Flow 2				Heating Water Flow 3			
							Water flow l/s	Water ΔP Kpa	Water Cooling Capacity W	ΔT Water deg C	Water flow l/s	Water ΔP Kpa	Water Cooling Capacity W	ΔT Water deg C	Water flow l/s	Water ΔP Kpa	Water Cooling Capacity W	ΔT Water deg C	Water flow l/s	Water ΔP Kpa	Water Heating Capacity W	ΔT Water deg C	Water flow l/s	Water ΔP Kpa	Water Heating Capacity W	ΔT Water deg C	Water flow l/s	Water ΔP Kpa	Water Heating Capacity W	ΔT Water deg C
2400	A0	14	43	≤15	≤15	170	0.06	3.4	940	3.3	0.09	7.7	960	2.5	0.12	13.8	1000	2.0	0.04	5.3	1460	8.7	0.05	9.4	1850	8.8	0.06	14.7	2030	8.1
		18	70	16	≤15	218	0.06	3.4	1010	4.0	0.09	7.7	1140	3.0	0.12	13.8	1190	2.4	0.04	5.3	1940	11.6	0.05	9.4	2460	11.8	0.06	14.7	2710	10.8
		22	105	21	16	287	0.06	3.4	1140	4.5	0.09	7.7	1290	3.4	0.12	13.8	1350	2.7	0.04	5.3	2320	13.9	0.05	9.4	2940	14.0	0.06	14.7	3240	12.9
		26	147	25	20	315	0.06	3.4	1250	5.0	0.09	7.7	1420	3.8	0.12	13.8	1480	2.9	0.04	5.3	2640	15.8	0.05	9.4	3340	16.0	0.06	14.7	3670	14.6
		30	196	29	24	364	0.06	3.4	1340	5.3	0.09	7.7	1520	4.0	0.12	13.8	1590	3.2	0.04	5.3	2910	17.4	0.05	9.4	3680	17.6	0.06	14.7	4050	16.1
2400	A1	19	51	≤15	≤15	230	0.06	3.4	940	3.7	0.09	7.7	1060	2.8	0.12	13.8	1110	2.2	0.04	5.3	1820	10.9	0.05	9.4	2310	11.0	0.06	14.7	2540	10.1
		23	75	20	≤15	279	0.06	3.4	1100	4.4	0.09	7.7	1250	3.3	0.12	13.8	1300	2.6	0.04	5.3	2200	13.1	0.05	9.4	2780	13.3	0.06	14.7	3060	12.2
		27	104	25	20	328	0.06	3.4	1230	4.9	0.09	7.7	1400	3.7	0.12	13.8	1460	2.9	0.04	5.3	2510	15.0	0.05	9.4	3180	15.2	0.06	14.7	3500	13.9
		31	137	28	23	376	0.06	3.4	1350	5.4	0.09	7.7	1530	4.1	0.12	13.8	1600	3.2	0.04	5.3	2780	16.6	0.05	9.4	3510	16.8	0.06	14.7	3870	15.4
		35	174	32	27	425	0.06	3.4	1450	5.8	0.09	7.7	1650	4.4	0.12	13.8	1720	3.4	0.04	5.3	3010	18.0	0.05	9.4	3810	18.2	0.06	14.7	4190	16.7
2400	B1	28	55	22	17	340	0.06	3.4	990	3.9	0.09	7.7	1120	3.0	0.12	13.8	1170	2.3	0.04	5.3	2000	11.9	0.05	9.4	2530	12.1	0.06	14.7	2780	11.1
		33	76	26	21	400	0.06	3.4	1120	4.5	0.09	7.7	1270	3.4	0.12	13.8	1320	2.6	0.04	5.3	2310	13.8	0.05	9.4	2930	14.0	0.06	14.7	3220	12.8
		38	101	30	25	461	0.06	3.4	1230	4.9	0.09	7.7	1390	3.7	0.12	13.8	1450	2.9	0.04	5.3	2580	15.4	0.05	9.4	3270	15.6	0.06	14.7	3590	14.3
		43	129	33	28	522	0.06	3.4	1320	5.3	0.09	7.7	1500	4.0	0.12	13.8	1570	3.1	0.04	5.3	2810	16.8	0.05	9.4	3560	17.0	0.06	14.7	3910	15.6
		48	161	36	31	582	0.06	3.4	1410	5.6	0.09	7.7	1600	4.2	0.12	13.8	1670	3.3	0.04	5.3	3010	18.0	0.05	9.4	3820	18.2	0.06	14.7	4200	16.7
2400	C1	37	52	27	22	449	0.06	3.4	1030	4.1	0.09	7.7	1170	3.1	0.12	13.8	1220	2.4	0.04	5.3	2110	12.6	0.05	9.4	2670	12.8	0.06	14.7	2940	11.7
		44	73	32	27	534	0.06	3.4	1150	4.6	0.09	7.7	1310	3.5	0.12	13.8	1360	2.7	0.04	5.3	2350	14.0	0.05	9.4	2980	14.2	0.06	14.7	3270	13.0
		51	99	35	30	619	0.06	3.4	1250	5.0	0.09	7.7	1420	3.8	0.12	13.8	1490	3.0	0.04	5.3	2590	15.5	0.05	9.4	3280	15.7	0.06	14.7	3600	14.3
		58	127	39	34	704	0.06	3.4	1340	5.3	0.09	7.7	1530	4.1	0.12	13.8	1590	3.2	0.04	5.3	2790	16.7	0.05	9.4	3540	16.9	0.06	14.7	3890	15.5
		65	160	42	37	788	0.06	3.4	1420	5.7	0.09	7.7	1610	4.3	0.12	13.8	1680	3.3	0.04	5.3	2980	17.8	0.05	9.4	3770	18.0	0.06	14.7	4150	16.5
2400	E1	48	50	31	26	582	0.06	3.4	1090	4.3	0.09	7.7	1240	3.3	0.12	13.8	1300	2.6	0.04	5.3	2300	13.7	0.05	9.4	2910	13.9	0.06	14.7	3200	12.7
		58	72	36	31	704	0.06	3.4	1220	4.9	0.09	7.7	1390	3.7	0.12	13.8	1450	2.9	0.04	5.3	2510	15.0	0.05	9.4	3180	15.2	0.06	14.7	3500	13.9
		68	99	40	35	825	0.06	3.4	1330	5.3	0.09	7.7	1510	4.0	0.12	13.8	1580	3.1	0.04	5.3	2700	16.1	0.05	9.4	3420	16.3	0.06	14.7	3760	15.0
		78	131	44	39	946	0.06	3.4	1420	5.7	0.09	7.7	1620	4.3	0.12	13.8	1690	3.4	0.04	5.3	2860	17.1	0.05	9.4	3630	17.3	0.06	14.7	3990	15.9
		88	166	47	42	1067	0.06	3.4	1510	6.0	0.09	7.7	1710	4.5	0.12	13.8	1780	3.5	0.04	5.3	3010	18.0	0.05	9.4	3810	18.2	0.06	14.7	4200	16.7
2400	F1	60	50	35	30	728	0.06	3.4	1150	4.6	0.09	7.7	1300	3.4	0.12	13.8	1360	2.7	0.04	5.3	2310	13.8	0.05	9.4	2920	13.9	0.06	14.7	3220	12.8
		72	72	40	35	873	0.06	3.4	1260	5.0	0.09	7.7	1430	3.8	0.12	13.8	1490	3.0	0.04	5.3	2530	15.1	0.05	9.4	3200	15.3	0.06	14.7	3520	14.0
		84	97	44	39	1019	0.06	3.4	1360	5.4	0.09	7.7	1540	4.1	0.12	13.8	1610	3.2	0.04	5.3	2710	16.2	0.05	9.4	3430	16.4	0.06	14.7	3780	15.0
		96	127	47	42	1164	0.06	3.4	1440	5.7	0.09	7.7	1640	4.4	0.12	13.8	1710	3.4	0.04	5.3	2870	17.1	0.05	9.4	3640	17.4	0.06	14.7	4000	15.9
		108	161	51	46	1310	0.06	3.4	1510	6.0	0.09	7.7	1720	4.6	0.12	13.8	1790	3.6	0.04	5.3	3020	18.0	0.05	9.4	3820	18.2	0.06	14.7	4200	16.7
2400	G1	70	53	39	34	849	0.06	3.4	1170	4.7	0.09	7.7	1330	3.5	0.12	13.8	1380	2.7	0.04	5.3	2380	14.2	0.05	9.4	3010	14.4	0.06	14.7	3310	13.2
		82	73	43	38	995	0.06	3.4	1270	5.1	0.09	7.7	1440	3.8	0.12	13.8	1500	3.0	0.04	5.3	2550	15.2	0.05	9.4	3230	15.4	0.06	14.7	3550	14.1
		94	95	46	41	1140	0.06	3.4	1360	5.4	0.09	7.7	1540	4.1	0.12	13.8	1610	3.2	0.04	5.3	2700	16.1	0.05	9.4	3420	16.3	0.06	14.7	3760	15.0
		106	121	49	44	1286	0.06	3.4	1440	5.7	0.09	7.7	1630	4.3	0.12	13.8	1700	3.4	0.04	5.3	2830	16.9	0.05	9.4	3590	17.1	0.06	14.7	3940	15.7
		118	150	52	47	1431	0.06	3.4	1510	6.0	0.09	7.7	1710	4.5	0.12	13.8	1790	3.6	0.04	5.3	2950	17.6	0.05	9.4	3740	17.9	0.06	14.7	4110	16.4
2400	H1	90	43	42	37	1092	0.06	3.4	1300	5.2	0.09	7.7	1470	3.9	0.12	13.8	1540	3.1	0.04	5.3	2510	15.0	0.05	9.4	3180	15.2	0.06	14.7	3500	13.9
		110	64	47	42	1334	0.06	3.4	1380	5.5	0.09	7.7	1570	4.2	0.12	13.8	1640	3.3	0.04	5.3	2670	15.9	0.05	9.4	3370	16.1	0.06	14.7	3710	14.8
		130	90	51	46	1577	0.06	3.4	1460	5.8	0.09	7.7	1660	4.4	0.12	13.8	1730	3.4	0.04	5.3	2800	16.7	0.05	9.4	3540	16.9	0.06	14.7	3900	15.5
		150	119	55	50	1820	0.06	3.4	1520	6.1	0.09	7.7	1730	4.6	0.12	13.8	1800	3.6	0.04	5.3	2920	17.4	0.05	9.4	3690	17.6	0.06	14.7	4060	16.2
		170	153	60	55	2062	0.06	3.4	1570	6.2	0.09	7.7	1790	4.8	0.12	13.8	1870	3.7	0.04	5.3	3020	18.0	0.05	9.4	3830	18.3	0.06	14.7	4210	16.8

Performance table notes

- 1) Air cooling capacities are based on Troom minus T primary air = 10 deg C. For other conditions multiply the table air cooling capacity by the required (Troom minus Tprimary air) divided by 10. Alternately the air cooling capacity can be calculated from the formula: Air cooling capacity W = 1.213 x Airflow (l/s) x (Troom minus T primary air)
- 2)

Performance Data AIRFIT 600

AIRFIT 600- 3000							Cooling Troom minus T entering water temperature = 10 deg C												Heating T entering water temperature minus T room = 35 deg C											
Model	Nozzle	Primary Airflow L/s	Plenum Pressure Pa	Sound Pressure Level dBA	Sound Pressure Level NC	Air Cooling Capacity ΔT=10C W	Cooling Water Flow 1				Cooling Water Flow 2				Cooling Water Flow 3				Heating Water Flow 1				Heating Water Flow 2				Heating Water Flow 3			
							Water flow l/s	Water ΔP Kpa	Water Cooling Capacity W	ΔT Water deg C	Water flow l/s	Water ΔP Kpa	Water Cooling Capacity W	ΔT Water deg C	Water flow l/s	Water ΔP Kpa	Water Cooling Capacity W	ΔT Water deg C	Water flow l/s	Water ΔP Kpa	Water Heating Capacity W	ΔT Water deg C	Water flow l/s	Water ΔP Kpa	Water Heating Capacity W	ΔT Water deg C	Water flow l/s	Water ΔP Kpa	Water Heating Capacity W	ΔT Water deg C
3000	A0	17	39	16	≤15	206	0.06	4.2	950	3.8	0.09	9.4	1090	2.9	0.12	16.7	1190	2.4	0.04	6.2	1850	11.0	0.05	11.0	2350	11.2	0.06	17.2	2580	10.3
		22	65	18	≤15	287	0.06	4.2	1140	4.5	0.09	9.4	1320	3.5	0.12	16.7	1430	2.8	0.04	6.2	2460	14.7	0.05	11.0	3120	14.9	0.06	17.2	3430	13.7
		27	98	24	19	328	0.06	4.2	1300	5.2	0.09	9.4	1500	4.0	0.12	16.7	1630	3.2	0.04	6.2	2950	17.6	0.05	11.0	3730	17.8	0.06	17.2	4100	16.3
		32	138	29	24	388	0.06	4.2	1430	5.7	0.09	9.4	1650	4.4	0.12	16.7	1790	3.6	0.04	6.2	3350	20.0	0.05	11.0	4230	20.2	0.06	17.2	4660	18.5
		37	185	33	28	449	0.06	4.2	1540	6.1	0.09	9.4	1780	4.7	0.12	16.7	1930	3.8	0.04	6.2	3690	22.0	0.05	11.0	4670	22.3	0.06	17.2	5130	20.4
3000	A1	24	51	18	≤15	291	0.06	4.2	1090	4.3	0.09	9.4	1260	3.3	0.12	16.7	1360	2.7	0.04	6.2	2310	13.8	0.05	11.0	2930	14.0	0.06	17.2	3220	12.8
		29	75	24	19	352	0.06	4.2	1270	5.1	0.09	9.4	1470	3.9	0.12	16.7	1590	3.2	0.04	6.2	2790	16.7	0.05	11.0	3530	16.9	0.06	17.2	3880	15.4
		34	102	28	23	412	0.06	4.2	1420	5.7	0.09	9.4	1650	4.4	0.12	16.7	1790	3.6	0.04	6.2	3180	19.0	0.05	11.0	4030	19.3	0.06	17.2	4430	17.6
		39	135	32	27	473	0.06	4.2	1560	6.2	0.09	9.4	1800	4.8	0.12	16.7	1950	3.9	0.04	6.2	3520	21.0	0.05	11.0	4460	21.3	0.06	17.2	4900	19.5
		44	172	35	30	534	0.06	4.2	1680	6.7	0.09	9.4	1940	5.1	0.12	16.7	2100	4.2	0.04	6.2	3810	22.7	0.05	11.0	4830	23.1	0.06	17.2	5310	21.1
3000	B1	34	50	25	20	412	0.06	4.2	1110	4.4	0.09	9.4	1280	3.4	0.12	16.7	1390	2.8	0.04	6.2	2540	15.2	0.05	11.0	3210	15.3	0.06	17.2	3530	14.1
		41	73	30	25	497	0.06	4.2	1280	5.1	0.09	9.4	1480	3.9	0.12	16.7	1600	3.2	0.04	6.2	2930	17.5	0.05	11.0	3710	17.7	0.06	17.2	4090	16.3
		48	100	34	29	582	0.06	4.2	1420	5.7	0.09	9.4	1640	4.4	0.12	16.7	1780	3.5	0.04	6.2	3270	19.5	0.05	11.0	4140	19.8	0.06	17.2	4560	18.2
		55	131	37	32	667	0.06	4.2	1540	6.1	0.09	9.4	1790	4.8	0.12	16.7	1940	3.9	0.04	6.2	3560	21.3	0.05	11.0	4510	21.5	0.06	17.2	4960	19.7
		62	167	41	36	752	0.06	4.2	1650	6.6	0.09	9.4	1910	5.1	0.12	16.7	2070	4.1	0.04	6.2	3820	22.8	0.05	11.0	4840	23.1	0.06	17.2	5320	21.2
3000	C1	50	59	33	28	607	0.06	4.2	1250	5.0	0.09	9.4	1450	3.8	0.12	16.7	1570	3.1	0.04	6.2	2670	15.9	0.05	11.0	3390	16.2	0.06	17.2	3720	14.8
		58	79	36	31	704	0.06	4.2	1370	5.5	0.09	9.4	1580	4.2	0.12	16.7	1720	3.4	0.04	6.2	2960	17.8	0.05	11.0	3770	18.0	0.06	17.2	4150	16.5
		66	103	40	35	801	0.06	4.2	1470	5.9	0.09	9.4	1700	4.5	0.12	16.7	1850	3.7	0.04	6.2	3280	19.6	0.05	11.0	4150	19.8	0.06	17.2	4570	18.2
		74	129	43	38	898	0.06	4.2	1560	6.2	0.09	9.4	1810	4.8	0.12	16.7	1960	3.9	0.04	6.2	3540	21.1	0.05	11.0	4480	21.4	0.06	17.2	4930	19.6
		82	159	47	42	995	0.06	4.2	1650	6.6	0.09	9.4	1910	5.1	0.12	16.7	2070	4.1	0.04	6.2	3780	22.6	0.05	11.0	4780	22.8	0.06	17.2	5260	20.9
3000	E1	62	52	35	30	752	0.06	4.2	1290	5.1	0.09	9.4	1490	4.0	0.12	16.7	1610	3.2	0.04	6.2	2910	17.4	0.05	11.0	3690	17.6	0.06	17.2	4060	16.2
		74	73	41	36	898	0.06	4.2	1430	5.7	0.09	9.4	1650	4.4	0.12	16.7	1790	3.6	0.04	6.2	3180	19.0	0.05	11.0	4030	19.3	0.06	17.2	4430	17.6
		86	99	45	40	1043	0.06	4.2	1540	6.1	0.09	9.4	1790	4.8	0.12	16.7	1940	3.9	0.04	6.2	3420	20.4	0.05	11.0	4330	20.7	0.06	17.2	4760	18.9
		98	129	49	44	1189	0.06	4.2	1650	6.6	0.09	9.4	1900	5.0	0.12	16.7	2060	4.1	0.04	6.2	3630	21.7	0.05	11.0	4600	22.0	0.06	17.2	5060	20.1
		110	162	52	47	1334	0.06	4.2	1740	6.9	0.09	9.4	2010	5.3	0.12	16.7	2180	4.3	0.04	6.2	3820	22.8	0.05	11.0	4840	23.1	0.06	17.2	5320	21.2
3000	F1	75	48	39	34	910	0.06	4.2	1320	5.3	0.09	9.4	1530	4.1	0.12	16.7	1660	3.3	0.04	6.2	2930	17.5	0.05	11.0	3710	17.7	0.06	17.2	4080	16.2
		90	70	45	40	1092	0.06	4.2	1450	5.8	0.09	9.4	1680	4.5	0.12	16.7	1820	3.6	0.04	6.2	3200	19.1	0.05	11.0	4050	19.3	0.06	17.2	4460	17.8
		105	95	49	44	1274	0.06	4.2	1570	6.2	0.09	9.4	1810	4.8	0.12	16.7	1960	3.9	0.04	6.2	3440	20.5	0.05	11.0	4350	20.8	0.06	17.2	4790	19.1
		120	124	52	47	1456	0.06	4.2	1660	6.6	0.09	9.4	1920	5.1	0.12	16.7	2090	4.2	0.04	6.2	3640	21.7	0.05	11.0	4610	22.0	0.06	17.2	5070	20.2
		135	157	55	50	1638	0.06	4.2	1750	7.0	0.09	9.4	2020	5.4	0.12	16.7	2190	4.4	0.04	6.2	3830	22.9	0.05	11.0	4840	23.1	0.06	17.2	5330	21.2
3000	G1	86	50	41	36	1043	0.06	4.2	1330	5.3	0.09	9.4	1540	4.1	0.12	16.7	1670	3.3	0.04	6.2	3010	18.0	0.05	11.0	3810	18.2	0.06	17.2	4200	16.7
		104	72	47	42	1262	0.06	4.2	1480	5.9	0.09	9.4	1710	4.5	0.12	16.7	1850	3.7	0.04	6.2	3230	19.3	0.05	11.0	4090	19.5	0.06	17.2	4500	17.9
		122	100	51	46	1480	0.06	4.2	1600	6.4	0.09	9.4	1850	4.9	0.12	16.7	2000	4.0	0.04	6.2	3420	20.4	0.05	11.0	4330	20.7	0.06	17.2	4760	18.9
		140	131	54	49	1698	0.06	4.2	1700	6.8	0.09	9.4	1970	5.2	0.12	16.7	2130	4.2	0.04	6.2	3590	21.4	0.05	11.0	4550	21.7	0.06	17.2	5000	19.9
		158	167	58	53	1917	0.06	4.2	1790	7.1	0.09	9.4	2070	5.5	0.12	16.7	2250	4.5	0.04	6.2	3750	22.4	0.05	11.0	4740	22.6	0.06	17.2	5210	20.7
3000	H1	120	48	49	44	1456	0.06	4.2	1530	6.1	0.09	9.4	1770	4.7	0.12	16.7	1920	3.8	0.04	6.2	3180	19.0	0.05	11.0	4030	19.3	0.06	17.2	4430	17.6
		145	69	53	48	1759	0.06	4.2	1630	6.5	0.09	9.4	1880	5.0	0.12	16.7	2040	4.1	0.04	6.2	3380	20.2	0.05	11.0	4280	20.4	0.06	17.2	4710	18.7
		170	95	56	51	2062	0.06	4.2	1710	6.8	0.09	9.4	1980	5.3	0.12	16.7	2140	4.3	0.04	6.2	3550	22.1	0.05	11.0	4490	21.4	0.06	17.2	4940	19.7
		195	125	58	53	2365	0.06	4.2	1780	7.1	0.09	9.4	2060	5.5	0.12	16.7	2230	4.4	0.04	6.2	3700	22.1	0.05	11.0	4680	22.4	0.06	17.2	5150	20.5
		220	160	63	58	2669	0.06	4.2	1840	7.3	0.09	9.4	2130	5.7	0.12	16.7	2310	4.6	0.04	6.2	3830	22.9	0.05	11.0	4850	23.2	0.06	17.2	5340	21.3

Performance table notes

- 1) Air cooling capacities are based on Troom minus T primary air = 10 deg C. For other conditions multiply the table air cooling capacity by the required (Troom minus Tprimary

Selection example

Specified data:

Office (LxWxH)	7.2 x 5.4 x 2.7 m
Occupants:	4
Minimum Ventilation	4 x 10 l/s = 40 l/s
Preferred size of chilled beams	1800 x 600 mm (2 units)
Summer room design condition (Troom) deg C)	24 deg C with 50% Relative Humidity (dew point 14 deg C)
Chilled Water temperature (Tw,in)	16 deg C (Room Dew Point 14 deg C + 2 deg C)
Summer supply air temperature (T1)	12 deg C
Summer sensible cooling requirement	2400 W or 1200 W per unit
Winter room design condition (Troom) C)	20 deg C with 50% Relative Humidity (dew point 9 deg C)
Heating water temperature (Tw,in)	45 deg C
Winter supply air temperature (T1)	20 deg C
Winter heating requirement	2700 W or 1350 W per unit

Calculation:

The temperature differences required to make the cooling selection are:

$$\Delta TAC = T_{room} - T_1 = 24 - 12 = 12 \text{ deg C}$$

$$\Delta TWC = T_{room} - T_{w,in} = 24 - 16 = 8 \text{ deg C}$$

The temperature differences required to make the heating selection are:

$$\Delta TAH = T_1 - T_{room} = 20 - 20 = 0 \text{ deg C}$$

$$\Delta TWH = T_{w,in} - T_{room} = 45 - 20 = 25 \text{ deg C}$$

Selection:

Model: Width:	600mm
Length:	1800mm
Performance table:	Page 9
Primary airflow:	28 l/s per unit
Nozzle:	B1
Static air pressure in plenum:	102 Pa

Cooling Performance

Available cooling from primary air:	$1.213 \times 28 \times 12 = 407 \text{ W per unit}$
Required cooling from chilled water:	$1200 - 407 = 793 \text{ W per unit}$
From page 9 select water cooling capacity	1000 W per unit at $\Delta TWC = 10 \text{ deg C}$
So water cooling capacity for $\Delta TWC = 8 \text{ deg C}$ with water flow	$1000 \times 8 \text{ deg C} / 10 \text{ deg C} = 800 \text{ W per unit}$ 0.06 l/s
water pressure drop:	10.8 K pa
water temperature difference	$800 \text{ W} / (4.187 \times 0.06 \text{ l/s} \times 1000) = 3.18 \text{ deg C}$
So total cooling capacity:	$407\text{W} + 800\text{W} = 1207\text{W per unit} \times 2 \text{ units} = 2414 \text{ W}$

This satisfies the total sensible cooling requirement of 2400 W for the room

Heating Performance

Available heating from primary air:	$1.213 \times 28 \times 0 = 0 \text{ W per unit}$
Required heating from heating water:	$1350 - 0 = 1350 \text{ W per unit}$
From page 9 select water heating capacity	1890 W per unit at $\Delta TWH = 25 \text{ deg C}$
So water heating capacity for $\Delta TWC = 25 \text{ deg C}$ with water flow	$1890 \times 25 \text{ deg C} / 35 \text{ deg C} = 1350 \text{ W per unit}$ 0.03 l/s
water pressure drop:	4.4 K pa
water temperature difference	$1890 \text{ W} / (4.187 \times 0.03 \text{ l/s} \times 1000) = 15 \text{ deg C}$
So total heating capacity:	$0\text{W} + 1350\text{W} = 1350 \text{ W} \times 2\text{unit} = 2700 \text{ W per unit}$

This satisfies the total sensible heating requirement of 2700 W

For non standard applications and/or selections, please contact our technical staff.

Guide Specifications

Barcol-Air AIRFIT 600 series active chilled beams shall be used to compensate for the external and internal heat loads of the building and shall maintain the thermal comfort in the room within the specified comfort and noise criteria.

Functional description

- Primary air will be supplied by the fresh air handling unit to the chilled beam air plenum box. The primary air shall then pass through the induction nozzles into the mixing section to mix with the induced room air before being distributed into the room by two slot diffusers.
- Induction nozzles shall induce air from the room through the inlet air diffuser and then through the fin and tube cooling/heating heat exchanger before mixing with the primary air and being supplied to the room. The size and quantity of induction nozzles shall be factory installed to provide the required unit capacity with the specified primary airflow, air inlet pressure and noise level.
- Heat exchangers shall be 2-pipe type for cooling only or cooling/heating changeover systems or 4 pipe type for systems with separate cooling and heating circuits.
- The units shall incorporate two linear slot air supply diffusers and shall be designed so that the supply air is discharged horizontally across the ceiling using the “Coanda” effect to increase the air throw of the units and to ensure the air mixing with the room air above the occupied zone. The inlet air diffuser for the room air shall be perforated or provided with linear bar air inlet grille and shall be easily removable for cleaning the heat exchanger and shall be provided with a safety hanging wires.

Construction of the chilled beam:

- The primary air plenum box shall be manufactured from galvanized sheet steel and shall have one or more circular air spigot connectors to ensure the inlet air velocity does not exceed 2 m/s. The plenum should be internally insulated to prevent condensation if the primary supply air temperature is less than the surrounding air dew point
- The nozzle plate and chilled beam body shall be manufactured from galvanized steel with a minimum thickness of 0.8mm.
- The heat exchangers shall be made from seamless copper tubes with aluminum fins and shall have 12 or 15 mm diameter water connections depending on unit's size and connections. The heat exchangers shall be suitable to operate at 15 bar working pressure and shall be factory pressure tested at 20 bar pressure.
- The supply air diffuser and room air inlet diffuser shall be manufactured from galvanized steel with a minimum thickness of 1.0 mm and shall be finished with polyester powder paint to RAL9010 with 20% gloss or with an alternative finish to be specified.

Dimensions

Width: The chilled beam shall be 595 mm wide.

Length: The units shall be 1200, 1500, 1800, 2400 and 3000 mm long or any intermediate length by special order.

Height: The height of the chilled beam (including distribution plenum) shall not be more than 242mm.

Installation

The chilled beam shall have 7 mm diameter mounting holes for suspension by 6mm diameter threaded rod or suspension wires.



BARCOL-AIR