



Pictured: FlexiSign (front, right) and FlexiFountain (left, rear) at Lake Wendouree, Ballarat VIC



Introducing FlexiSign by CIVIQ: the modular signage solution ideal for public wayfinding and community information displays

The FlexiSign is our unique modular signage system developed for use across a broad range of indoor and outdoor applications.

Available in eight unique profiles, the product can be configured in a range of signage formats, including freestanding totem or pylon, horizontal stand, cantilevered blade, wall-mounted, suspended, pole-mounted, as well as portable options.

The system is fabricated with structural marine-grade aluminium

and stainless steel modular componentry.

FlexiSign graphics panels are interchangeable for easy replacement, minimising both cost and time spent on signage maintenance

The freestanding totem variants are also available with an optional in-built polycarbonate interchangeable poster display case for printed public messages and timetables.

The FlexiSign system is particularly popular with the public transport sector, and has been specified by authorities across Australia for decades – with proven performance. It is suited to all types of public spaces, such as outdoor campuses and precincts, parks and waterfronts, schools, universities, sports and camping grounds, bush walking sites, as well as indoor settings.

Specified by authorities across Australia for over 25 years





What our past clients have said

“CIVIQ was engaged by Bankstown City Council for the supply and installation of various sizes and types of FlexiSigns, including bus stop plinths for the Bankstown CBD Bus Interchange.

The delivery of the signs was timely, met the project deadlines and the installation was undertaken to a high and professional standard”

Ray Saleam, Team Leader Capital Works
Bankstown City Council

“The performance of the FlexiSign product is very good in its ability to meet its ‘fitness for purpose’ with no or minimal maintenance requirements ... and is backed up by excellent after sales support”

Grant Cooper, Project Manager (Signage)
Public Transport Victoria

How the FlexiSign system works

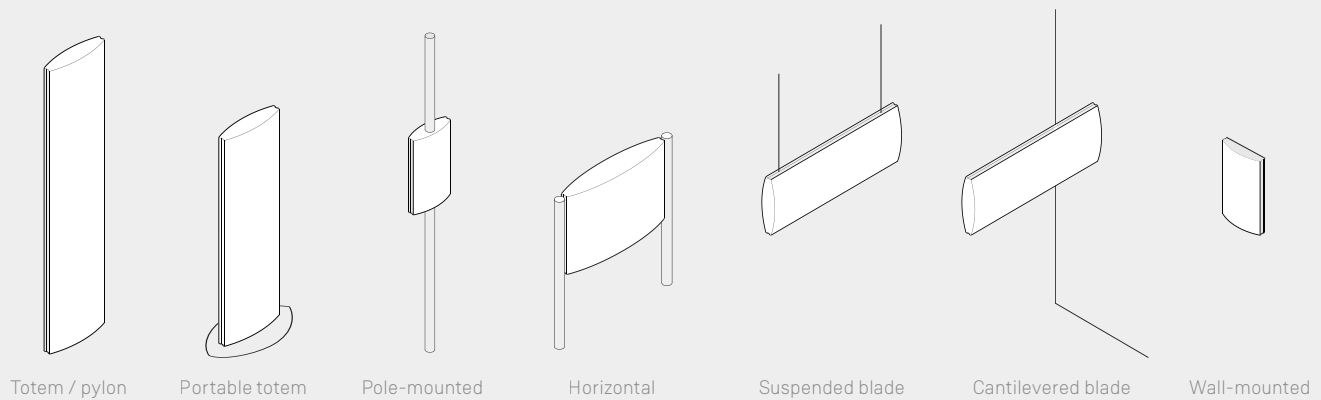

1 Select a signage format

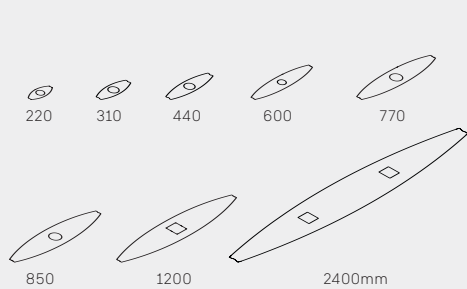

2 Choose a profile

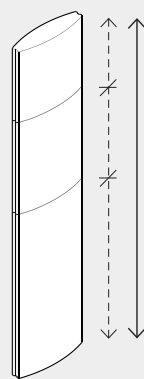

3 Define the length

+ quantity of modules
+ heights

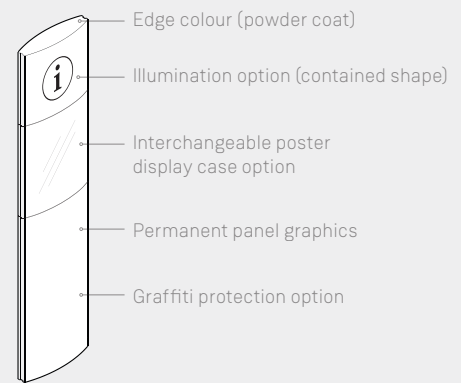

4 Customise the specification

CIVIQ's Design, Fabrication & Installation services

CREATE A CUSTOM DESIGNED SOLUTION

The CIVIQ design team has extensive experience in designing and managing wayfinding and signage projects - from scoping, to conceptual design, finished artwork, printing, manufacture, installation, after-service maintenance and technical support.

Please contact our team at design@civiq.com.au or phone **1300 600 300** for more information.

SUPPLY YOUR OWN ARTWORK

We regularly work with Wayfinding Design Studios, Councils, Schools and Business Communications Departments who supply us with their signage artwork for manufacture and installation.

The CIVIQ team can provide 1:1 scale signage panel graphic design templates as well as technical support throughout the process.

Popular FlexiSign configurations

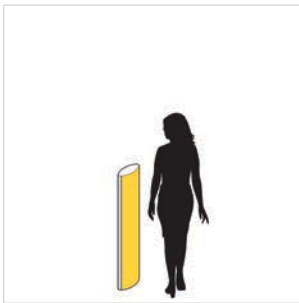

FlexiSign Totem 220

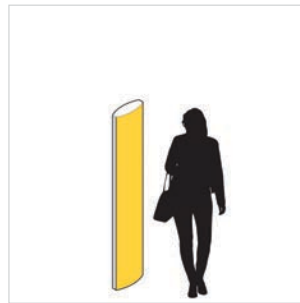

FlexiSign Totem 310

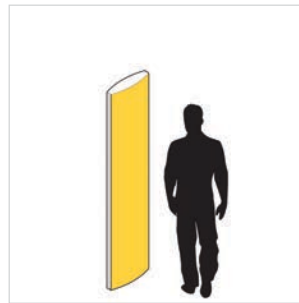

FlexiSign Totem 440

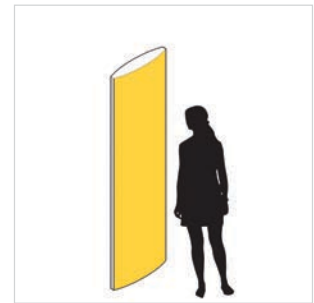

FlexiSign Totem 600

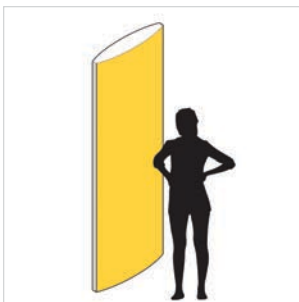

FlexiSign Totem 770

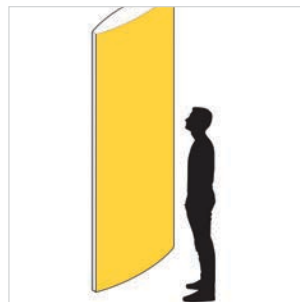

FlexiSign Totem 850

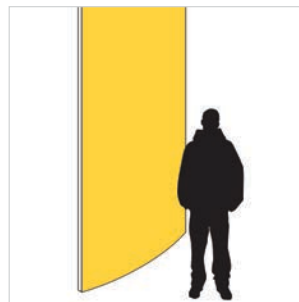

FlexiSign Pylon 1200

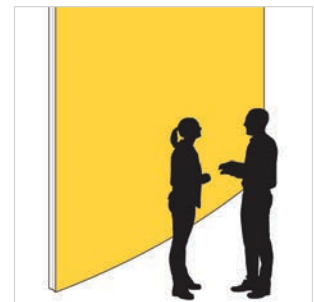

FlexiSign Pylon 2400

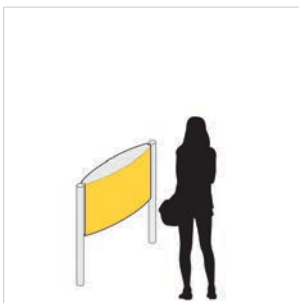

FlexiSign Horizontal 770

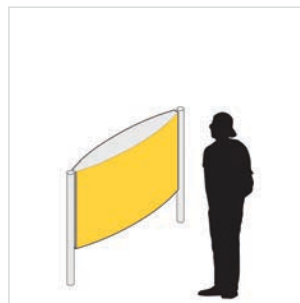

FlexiSign Horizontal 1200

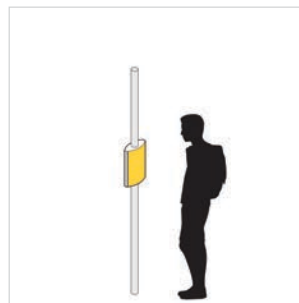

FlexiSign Pole-mounted A4

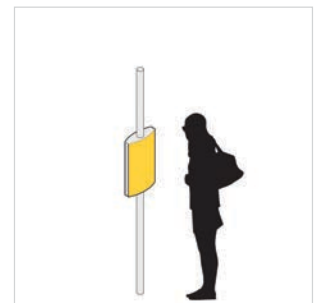

FlexiSign Pole-mounted A3

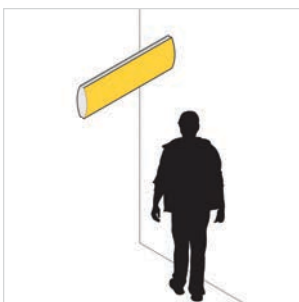

FlexiSign Cantilevered Blade 310



FlexiSign Cantilevered Blade 440

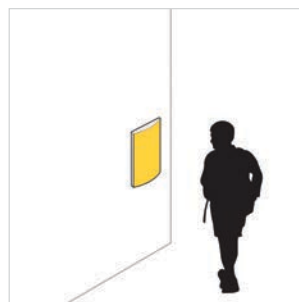

FlexiSign Wall-mounted A3

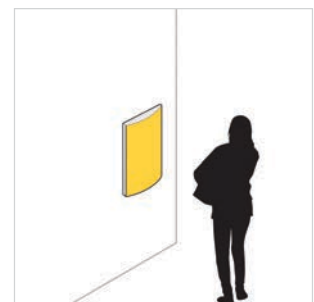

FlexiSign Wall-mounted A2

Past projects



FlexiSign projects

Commercial complex pylon sign
Warrawong Development Group (NSW)
FlexiSign Pylon 1200

Shared path wayfinding
Shire of Melton (VIC)
FlexiSign Totem 220

Info help points
University of Tasmania (TAS)
FlexiSign Totem 440

Bus & Tram stop timetable displays
Public Transport Victoria
*FlexiSign Totem 440 &
FlexiSign Pole-mounted A4*



Point of Sale signage stands
 Maytronics (AUS)
FlexiSign Totem 770 Portable



FlexiSecure

Bike rack with integrated
 instructional sign
 Shoalhaven Council (NSW)
FlexiSecure Bike rack

Related
 product by
 CIVIQ



FlexiFountain FlexiShower

Drinking Water & Shower Stations
 Busselton (WA)
*Aquafil FlexiFountain 2100BF &
 Aquafil FlexiShower*

Related
 products
 by CIVIQ

Detail product information

Product features

- Robust & economical design
- Indoor & outdoor use
- Modular componentry with interchangeable graphics panels for low replacement / upgrade cost
- Eight profiles to choose from
- Customise the length/height of your signs
- Available in several formats, including totem or pylon (freestanding), horizontal stand, cantilevered blade, wall-mounted, pole-mounted, suspended hanging, or portable
- Customisable graphics
- Structural marine-grade aluminium and stainless steel
- Long-lasting digital vinyl graphics to signage surface
- Powder coated or anodised edge finishes in custom colours
- Australian designed and made
- Installation and maintenance (on request)

Additional options

- Optional interchangeable poster display case
- Optional LED backlit illumination across top portion (totem variant)
- Optional portable wheel-base
- Optional anti-graffiti protection

Technical Details

Fixing options	Bolt-down base plate Or, fixed below-ground leg with footing tie pin	
Material & finish options	Stainless steel and structural marine-grade aluminium Powder coat or anodised (custom colours available on request) Custom panel graphics	
Signage profile options	220mm wide 310mm wide 440mm wide 600mm wide	770mm wide 850mm wide 1200mm wide 2400mm wide
Graphics panel options	Graphics panels are fabricated in modules and can be configured in custom sizes. Graphic panel modules are interchangeable for easy replacement and maintenance	
Poster display case option	In-built interchangeable poster display case available on all models of totem	
Anti-graffiti option	Protective anti-graffiti film to graphics (on request)	
Illumination option	Backlit LED illumination available on request. Contact CIVIQ sales team for further information.	

Construction detail:
600mm wide FlexiSign Totem (typical)

