

# Fytogreen

## Roof Gardens

**GENERAL SPECIFICATIONS**

UPDATED 06.2018

.... we are committed to providing sustainable living roofs for healthy, ecologically responsible buildings.

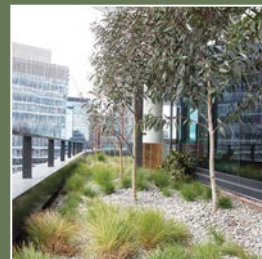

[www.fytogreen.com.au](http://www.fytogreen.com.au)

# Extensive Roof Gardens

PROFILE DEPTH: 140mm - 200mm

From the new residential home to greening a garage roof or home extension – all the way to an extensive roof on a large commercial building – extensive roof gardens are the latest in the sustainability tool kit for acoustic and temperature insulation, water management and aesthetic beauty.

Extensive and semi-extensive roof gardens have a thin growing medium <200mm deep, planted with predominantly native vegetation.

Fytogreen designs roof gardens specifically to suit the site conditions, inclusive of weight and set down limitations. All Fytogreens roof gardens are irrigated and designed for low maintenance.

**PLEASE NOTE: We do not supply the waterproof membranes, however we will direct you to the most suitable membrane systems.**



PRIVATE RESIDENCE - BALACLAVA, VIC (34m2)



NEW BENDIGO HOSPITAL, VIC (5,353m2)



CGRSO LIBRARY, QLD (255m2)



PRIVATE RESIDENCE - LANGWARRIN, VIC (12m2)



VIC DESALINATION PLANT, WONTHAGGI (27,000M2)



AMENITIES BLOCK, NORTH BONDI, NSW (90m2)

## 1. Extensive Roof Garden (140-200mm Profile)

### Typical Specification

#### 1.1 LDPE layer at a minimum of 200 micron.

This layer is 200-300µ thick with a gsm of approximately 200gm. The function is a protection layer to the membrane at the initial installation stage, as well as a long term root protection layer for the membrane.

#### 1.2 Drainage Cell: 20mm Atlantis Flo Cell 20

The drainage cell is HDPE with a crush strength of 200kPa and is fungus resistant. The thickness is 20mm with a weight of 1500gsm. Flo cell will hold 1.8lt/m<sup>2</sup> of water in the cup's for re-absorption by roots when required.

#### 1.3 Geofabric: Bidim A14-A24

Bidim "A" is a non-woven, needle punched, continuous filament, polyester textile made in Australia from recycled polymer. The geofabric layer is 2mm thick and has a wet weight of 360gsm.

#### 1.4 Hydrocell 40 Extensive Media

Hydrocell 40 Extensive Media is a proprietary engineered combination of scoria in two size grades (other mineral material is used where scoria is not economically available), composted pine bark and hydrocell flakes. The thickness is specific to the weight allowance for the project, but as a quick check guide 11kg/m<sup>2</sup>/10mm of depth as a saturated weight allowance.

The function is to provide a very lightweight, non hydrophobic low organic content media that is stable over time, has excellent capillary properties for sub surface irrigation, good shear strength due to particle shape for sloped surfaces and is suitable for a wide range of plant species.

#### 1.5 Stone Mulch Layer: 20mm scoria, recycled concrete or basalt.

14-20mm material is used as a stone mulch in a range of locally available materials.

Functions are to reduce the opportunity for blow-in weed species to readily establish as well as provide a stable ballast layer protecting the substrate layer during plant establishment from excessive wind.

#### 1.6 Sub Surface Drip Irrigation

Netafirm R Techline AS with emitter spacing of 150mm and a flow rate of 1lt / emitter / hr. buried 30-40mm in the media profile at 400mm row spacing will ensure a uniform moisture application.



## 1.7 Plants

A wide range of plant species can be selected subject to the site and climatic conditions at a range of densities to fit the client expectations. (Contact Fytogreen for a detailed design)

## 1.8 Optional Item: L-Profile Edge

1.2mm Stainless Steel edge profile to retain the garden from the box gutter.

The standard height is 150mm, with vertical slits for fast water penetration, folded along the top edge for improved rigidity. L-Profile is made to order, so height options available.

The L-Profile has holes in the base, so it can be flashed welded or sikaflexed into position on the underlying membrane, ensuring no penetrations through the membrane.

The parapet edge should ideally be a minimum of 20mm higher than the garden.

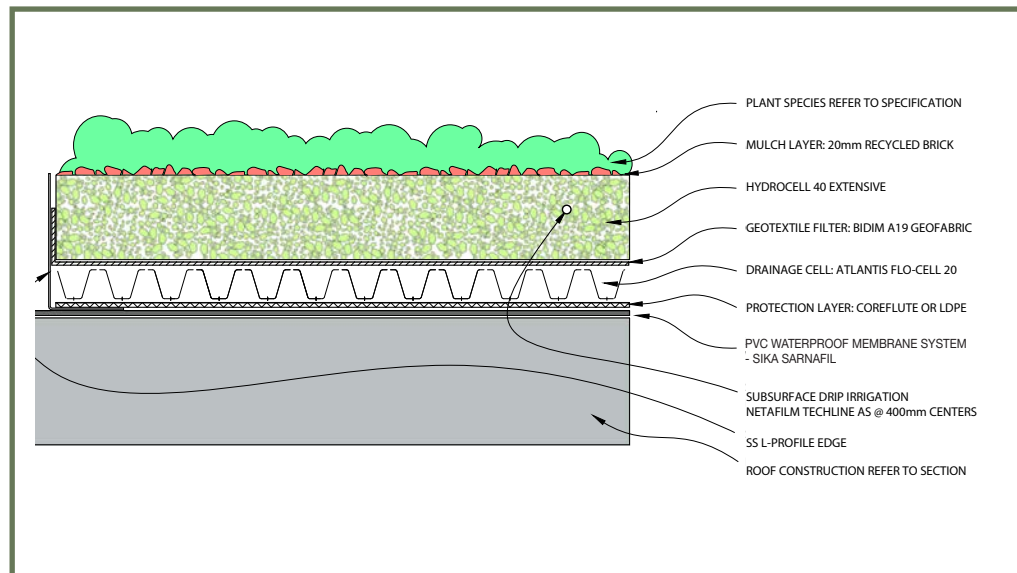

*L-Profile System to be build up and used on existing roofs.*

## 1.9 Saturated Weight Allowance Guide (see following page)

- Extensive Weight Guide  
140mm to 200mm

**NB: Water proofing and independent certification of the water proof membrane is “work by others”**

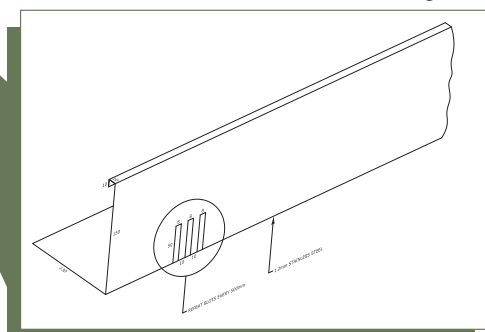

**PHONE FYTOGREEN FOR MORE DETAILS 1300 182 341**

# Saturated Weight Guide - Extensive Roof Garden - 140mm to 250mm

(06.18)

Fytogreen Australia's lightweight extensive roof garden system works to the following depth options and saturated weight guidelines.

**Saturated Bulk Density is 980kg/m<sup>3</sup>**

<b>PLANTS</b>	Allow 25kg / m <sup>2</sup> <i>Plant Species refer to Specifications</i>				
<b>LAYER 5 Stone Mulch</b>	20mm Scoria or Recycled Stone Mulch <i>NB: Outside Melbourne, recycled concrete or clinker ash are used to replace scoria, the weight is similar.</i>				
<b>LAYER 4 Soil Mix</b>	100mm depth 98kg psm	110mm depth 108kg psm	120mm depth 117kg psm	130mm depth 127kg psm	160mm depth 157kg psm
<b>LAYER 3 Geo-textile Membrane</b>	Various types such as Bidim A14 Thickness 2mm - Weight Negligible				
<b>LAYER 2 Drainage Layer</b>	Allow 20mm for Atlantis Flo-Cell 20				
<b>LAYER 1 Vapour Layer</b>	LDPE plastic is laid as extra protection above the waterproof roof Thickness 0.02mm - Weight Negligible				

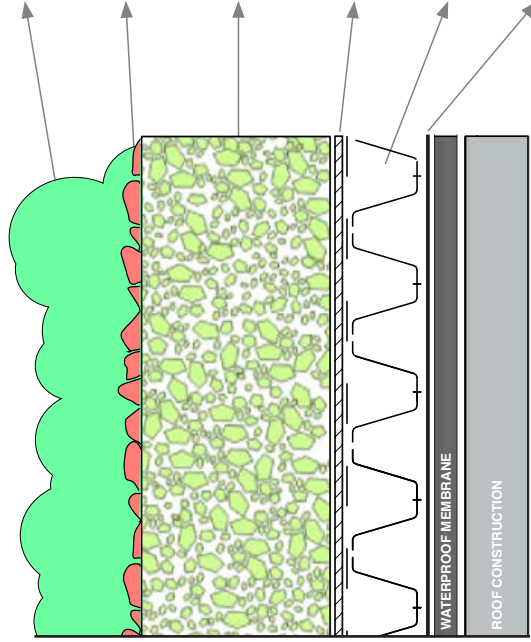

## Hydrocell140 Extensive Roof Garden Mix (HY40)

Used with in VIC

(Saturated Bulk Density 980kg/m<sup>3</sup>)

- 40% Hydrocell Flakes
- 35% 10-14mm Scoria
- 15% Composted Organic Matter
- 10% <7mm Scoria by Volume.

## Hydrocell140 Podium Mix

Used with in NSW and QLD

(Saturated Bulk Density 980kg/m<sup>3</sup>)

- 45% Clinker Ash
- 40% Hydrocell Flakes
- 15% Composted Organic Matter

PLEASE NOTE: Soil mix layer includes 20% for particle integration. The parapet should be 20mm higher than the finished garden level.

<b>Total Depth</b>	140mm	150mm	160mm	170mm	200mm	250mm
<b>Total Saturated Weight</b>	139kg/m <sup>2</sup>	149kg/m <sup>2</sup>	158kg/m <sup>2</sup>	168kg/m <sup>2</sup>	198kg/m <sup>2</sup>	247kg/m <sup>2</sup>
<b>Total Water at Field Capacity:</b>	38 litres/m <sup>2</sup>	41 litres/m <sup>2</sup>	44 litres/m <sup>2</sup>	48 litres/m <sup>2</sup>	58 litres/m <sup>2</sup>	74 litres/m <sup>2</sup>

*Disclaimer:* This information is supplied in good faith and trials are recommended by the user to test the suitability of the procedure in their climatic region. No liability will be accepted by Fytogreen Australia or its representatives as to the final performance based on this information.





# Intensive Roof Gardens, Podium and Planter Boxes

PROFILE DEPTH: 200mm -1500mm +

Intensive roof gardens are typically heavier than extensive gardens, with a garden profile depth of 200-1500mm+ supporting substantial vegetation, shrubs and trees – a landscaped space for people to use for recreation, gardens or a natural habitat.

Fytogreen are proud to have supplied over 550,000m<sup>2</sup> of roof gardens and roof garden media components throughout Australia . We assist landscape architects, garden designers and supplies components to landscape contractors for intensive roof gardens.

**PLEASE NOTE:** We do not supply the waterproof membranes, however we will direct you to the most suitable membrane systems.



## 2. Fytogreen Intensive Roof Garden, Podium and Planter Box (200mm Plus Profile)

### Typical Specification

#### 2.1 LDPE layer at a minimum of 200 micron.

This layer is 200-300µ thick with a gsm of approximately 200gm. The function is a protection layer to the membrane at the initial installation stage, as well as a long term root protection layer for the membrane.

#### 2.2 Coreflute protection board

Minimum 2.5 mm for vertical planter wall membrane protection.

#### 2.3 Drainage Cell: Atlantis Flocell 20 drainage cell

The drainage cell is HDPE with a crush strength of 200kPa and is fungus resistant. The thickness is 20mm with a weight of 1500gsm. Flo cell 20 will hold 1.8lt/m<sup>2</sup> of water in the cusp's for re-absorption by roots when required. Flow rate of 200lt/min at a 1% gradient.

#### 2.4 Geofabric: Bidim A14-A24

Bidim "A" is a non-woven, needle punched, continuous filament, polyester textile made in Australia from recycled polymer. The geofabric layer is 2mm thick and has a wet weight of 360gsm.

#### 2.5 Hydrocell RG30 – Water Reservoir Layer

Hydrocell is a proprietary urea aldehyde resin based hardfoam that is either manufactured directly onto the roof or delivered in a pre-manufactured sheet composition, as either a 60mm or 100mm layer.

The dry weight is 4kg/m<sup>2</sup>, which is complemented by it's ability to absorb water into the open cell structure to reach a field capacity weight of up to 55kg/m<sup>2</sup>.

The functions of the layer are numerous:

- Water reservoir of up to 51lt/m<sup>2</sup> at field capacity per 100mm
- Fines filter, protecting the geofabric layer from blockage of media fines.
- Excellent growing media in it's own right, with a balanced air water ratio at field capacity.
- Non-hydrophobic, so can be easily re-wet if the situation arises.
- Excellent capillary properties enabling water to be moved upwards through the profile.

The Hydrocell RG30 layer is made up of interconnected small to medium cells or pore spaces, enabling the usable media volume to be approximately 99%.



## 2.6 Hydrocell 40 Lightweight Planter Media

Hydrocell 40 Lightweight Planter Media is a proprietary engineered combination of medium washed sand and scoria (other mineral material is used where scoria is not economically available), composted pine bark and hydrocell flakes. The thickness is specific to the weight allowance for the project, but as a guide 12kg/m<sup>2</sup>/10mm of depth as a saturated weight allowance.

The function is to provide a lightweight, non hydrophobic low organic content media that is stable over time, has excellent capillary properties for sub surface irrigation, good shear strength due to particle shape for sloped surfaces, high hydraulic conductivity and is suitable for a wide range of plant species.

## 2.7 Stone Mulch Layer: 20-40mm scoria, recycled concrete, bluestone or basalt.

20-40mm material is used as a stone mulch in a range of locally available materials.

Functions are to reduce the opportunity for blow in weed species to readily establish as well as provide a stable ballast layer protecting the substrate layer during plant establishment from excessive wind.

## 2.8 Plants

A wide range of plant species can be selected subject to the site and climatic conditions at a range of densities to fit the client expectations.

Controlled release fertiliser is selected to suit the plant species planted.

## 2.9 Sub-surface irrigation

Fytogreen in conjunction with Netafim Australia design and install irrigation systems to suit the site requirements.

## 2.10 Saturated Weight Allowance Guide (see following page)

Intensive Weight Guide  
(inc. planter boxes and podiums)  
245mm to 945mm

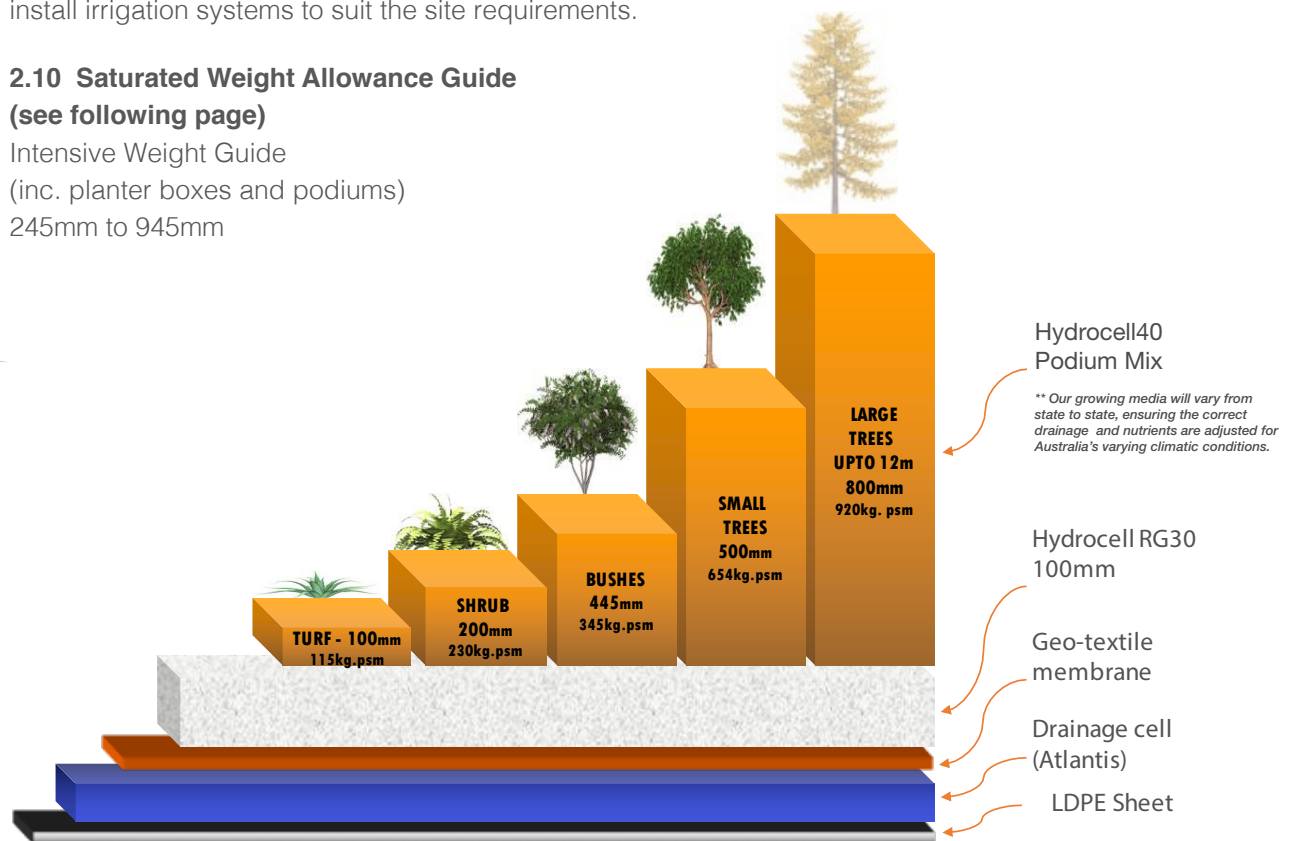



# Saturated Weight Guide- Intensive Podiums & Planter Boxes - 245mm to 945mm

(06.18)

Fytogreen Australia's lightweight roof garden system works to the following depth and saturated weight guidelines.

## Saturated Bulk Density is 1150kg/m<sup>3</sup>

PLANTS	Turf	Shrubs	Bushes	Small Trees Small trees with flat root system	Trees Large trees upto 12 metres
<b>LAYER 5 Soil Mix</b>	100mm depth 115kg psm	200mm depth 230kg psm	300mm depth 345kg psm	500mm depth 570kg psm	800mm depth 920kg psm
<b>LAYER 4 Hydrocell Hardfoam</b>	RG-30 Sheet, 60mm or 100mm thick. Saturated Weight Allowance of 55kg/m <sup>2</sup> (51kg Water & 4kg Hardfoam) / 100mm layers				
<b>LAYER 3 Geo-textile Membrane</b>	Various types such as Bidim A14G. Thickness 2mm - Weight Negligible				
<b>LAYER 2 Drainage Layer</b>	Allow 20mm for Atlantis Flo-Cell				
<b>LAYER 1 Vapour Layer</b>	LDPE plastic is laid as extra protection above the waterproof roof. Thickness 0.02mm - Weight Negligible				

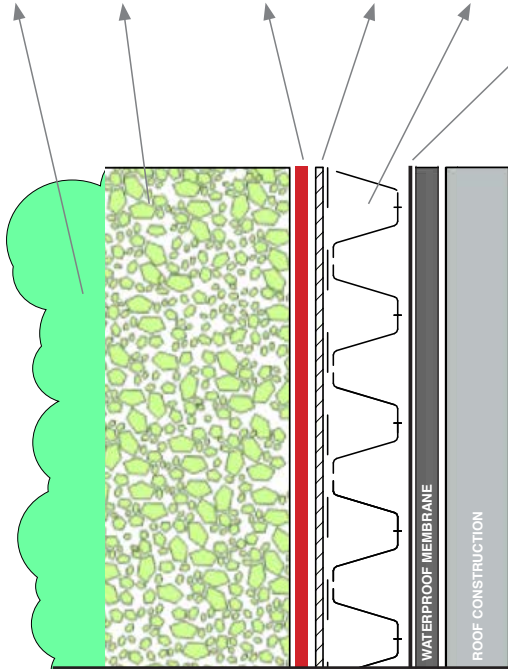

**Hydrocell40 Podium Mix  
Used with in VIC and SA**  
(Saturated Bulk Density 1150kg/m<sup>3</sup>)

- 40% Hydrocell Flakes
- 30% Washed Sand
- 20% Scoria
- 10% Composted Pine Bark by volume

**Hydrocell40 Podium Mix  
Used with in NSW and QLD**  
(Saturated Bulk Density 980kg/m<sup>3</sup>)

- 45% Clinker Ash
- 40% Hydrocell Flakes
- 15% Composted Organic Matter

<b>Total Depth</b>	245mm	345mm	445mm	645mm	945mm
<b>Total Weight</b>	170kg/psm	285kg/psm	400kg/psm	625kg/psm	975kg/psm
<b>Estimated Water</b>	84 litres	117 litres	150 litres	216 litres	315 litres

PLEASE NOTE: Soil mix layer includes 20% for particle integration. The parapet should be 20mm higher than the finished garden level.

Disclaimer: This information is supplied in good faith and trials are recommended by the user to test the suitability of the procedure in their climatic region. No liability will be accepted by Fytogreen Australia or its representatives as to the final performance based on this information.





# Sloping Roof Gardens

SUPPORTING SLOPES FROM 15° TO 45°

Fytogreen support the use of 'The Geoweb® Cellular Confinement System's for any roof garden with a slope above 15 degrees.

This unique design provides resistance to sliding for thin soil profiles on steep slopes, which ultimately allows for the construction of a previously unfeasible, living green roof up to a 45° slope. The design is ratified by Geofabrics Australia.

THE GROUNDS OF ALEXANDERIA, NSW (30°)

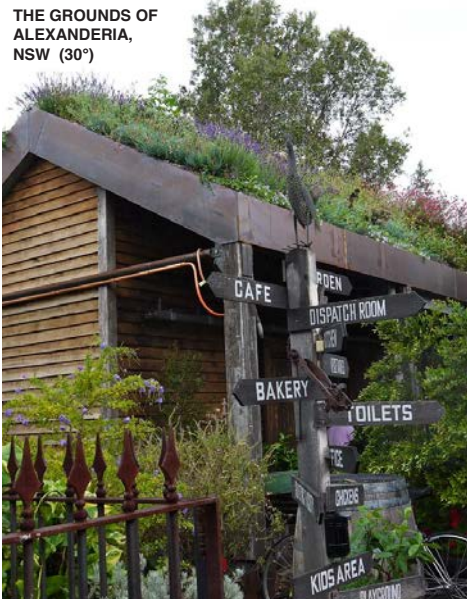

WONTHAGGI DESANINATION PLANT, VIC (20°)

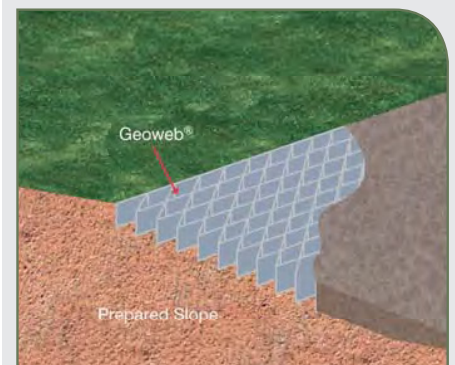

The Geoweb® system is the most advanced soil stabilization technology available on the market today. Initially developed by the US army to allow trafficking of heavy vehicles over very soft ground.

The Geoweb® system consists of a flexible, high-strength network of interconnected cells that confine and stabilize soil. Geoweb® is widely used around Australia as a support platform in unsealed roads, on slopes and in low velocity channels.

A variety of infill materials can be used depending on the problem, including topsoil with selected vegetation, sand and gravel, larger rock and stone and concrete.

The system is made from high quality polyethylene in collapsed, lightweight panels that are easily and safely handled on-site. Geoweb® has a solid reputation for quality and innovation and is manufactured to the highest international standard with ISO9001:2008 accreditation.

Geofabrics supports the Geoweb® system with design and support and installation tools.





# Roof Garden Media

## HY40 LIGHTWEIGHT PLANTER MEDIA MIX

Hydrocell 40 Lightweight Planter Media is a proprietary engineered combination of medium washed sand and scoria (other mineral material is used where scoria is not economically available), composted pine bark and hydrocell flakes. The thickness is specific to the weight allowance for the project, but as a guide 12kg/m<sup>2</sup>/10mm of depth as a saturated weight allowance.

**The function is to provide a lightweight, non hydrophobic low organic content media that is stable over time, has excellent capillary properties for sub surface irrigation, good shear strength due to particle shape for sloped surfaces, high hydraulic conductivity and is suitable for a wide range of plant species.**

Fytogreen's Hydrocell growing medium is tested in a variety of climatic and planting conditions, assisting in conserving water and providing a most efficient water-saving systems available.

**hydrocell**™ 40  
podium mix by *fyto*green



# Water Reservoir Layer

## HYDROCELL RG-30

Hydrocell is a proprietary urea aldehyde resin based hardfoam that is delivered in a pre-manufactured sheet composition.

The dry weight is 4kg/m<sup>2</sup>/100mm, which is complemented by its ability to absorb water into the open cell structure to reach a field capacity weight of up to 55kg/m<sup>2</sup>/100mm. The Hydrocell RG30 layer is made up of interconnected small to medium cells or pore spaces, enabling the usable media volume to be approximately 99%.

Available in 30mm, 60mm or 100mm depths.





FOR MORE INFORMATION CONTACT:

**Fytogreen Australia Pty Ltd**

**3 Webbs Lane, Somerville, Victoria, 3912**

**Ph: 1300 182 341**

**Email: [info@fytogreen.com.au](mailto:info@fytogreen.com.au)**



**[www.fytogreen.com.au](http://www.fytogreen.com.au)**