

Profile	Transit 091
Material	S/S T316, T304
Finish	Mill
Max. Width	3000mm
Max Length	As per Application
Open Area	76%
Weight	2.64 kg/m ²
Stock Status	Custom Made
Type	Flexible
Wire Dia	0.9mm
Aperture Form	5.5 x 5.6 x 0.9mm



* Typical Architectural Installation

Applications:

Building Facades, Curtains, Ceilings

Attachment Methods:

Locker Group Fixing systems; including Angle, Cap, Flat Bar or Tensioned. See website for more details.

Extra Notes:

Dimensions are nominal

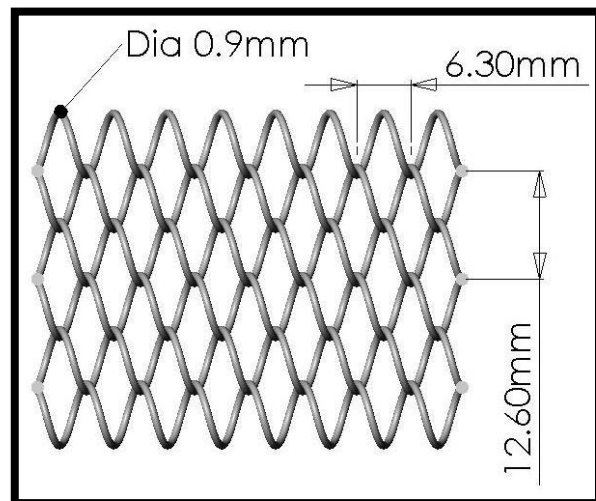
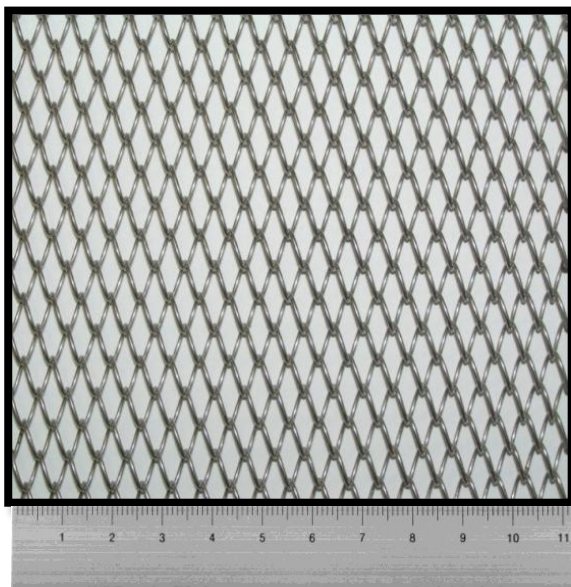

Profile	Transit 210
Material	S/S T316, T304, Galv, Brass
Finish	Mill
Max. Width	5000 mm
Max Length	As per Application
Open Area	56%
Weight	4.56 kg/m ² (S/S)
Stock Status	Custom Made
Type	Flexible
Wire Dia	1.25mm
Aperture	7.25 x 7.25mm
Form	Roll



* Typical Architectural Installation

Applications:

Building Facades, Curtains, Ceilings

Attachment Methods:

Locker Group Fixing systems; including Angle, Cap, Flat Bar or Tensioned. See website for more details.

Extra Notes:

Dimensions are nominal

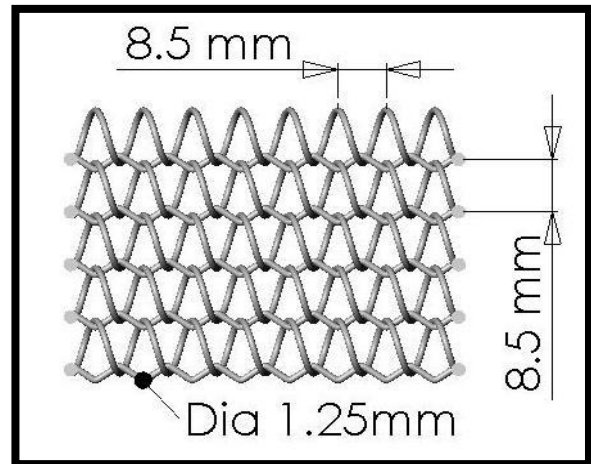
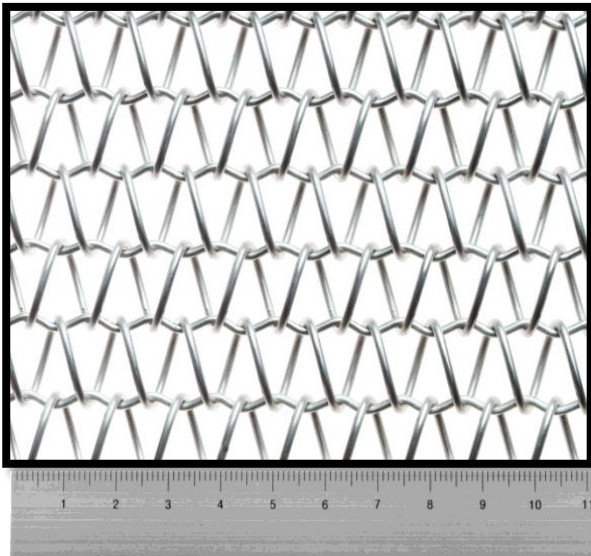

Profile	Transit F281
Material	S/S, T316, T304
Finish	Mill
Max. Width	3000mm
Max Length	As per Application
Open Area	19%
Weight	8.6 kg/m ² (S/S)
Stock Status	Custom Made
Type	Flexible
Wire Dia	2.8/1.0 Ribbon
Aperture	5.7 x 13.3
Form	Roll



* Typical Architectural Installation

Applications:

Building Facades, Roller Curtains

Attachment Methods:

Locker Group Fixing systems; including Angle, Cap, Flat Bar or Tensioned. See website for more details.

Extra Notes:

Dimensions are nominal

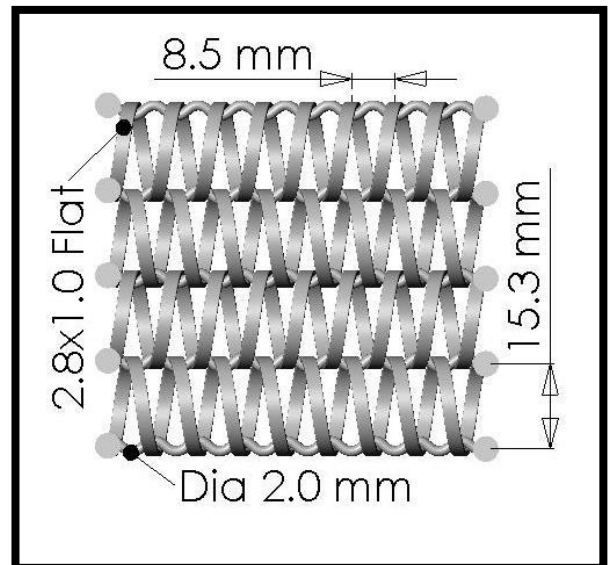
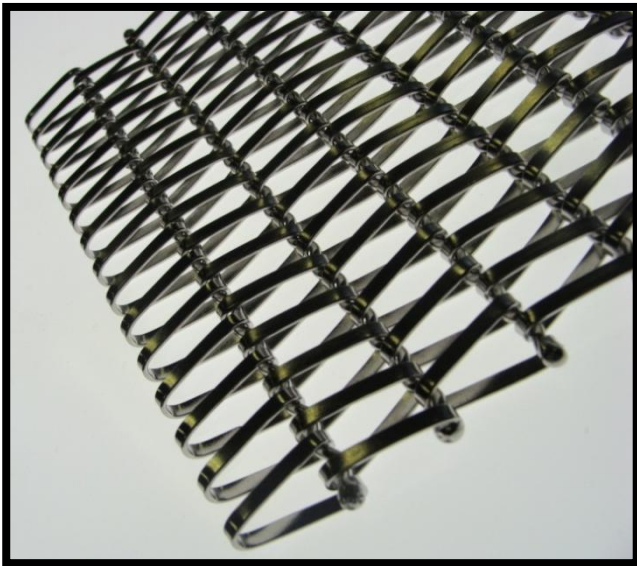

Profile	Transit F160
Material	S/S T316, T304
Finish	Mill
Max. Width	3000mm
Max Length	As per Application
Open Area	19%
Weight	10.2 kg/m ²
Stock Status	Custom Made
Type	Flexible
Wire Dia	1.6/0.7 Ribbon
Aperture	3.5 x 6.5mm
Form	Roll



* Typical Architectural Installation

Applications:

Facades, Curtains, Sunshades

Attachment Methods:

Locker Group Fixing systems; including Angle, Cap, Flat Bar or Tensioned. See website for more details.

Extra Notes:

Dimensions are nominal

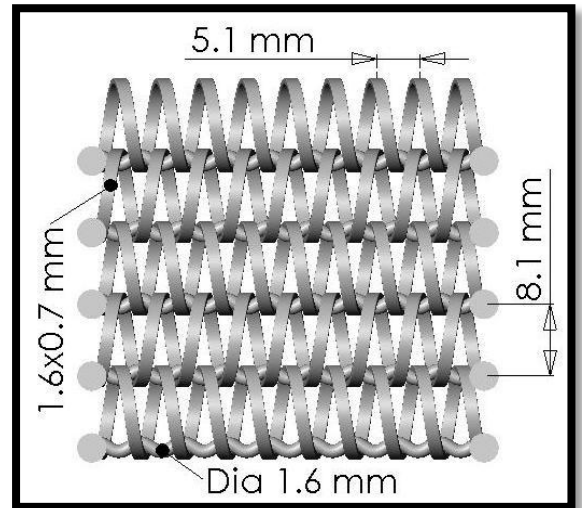
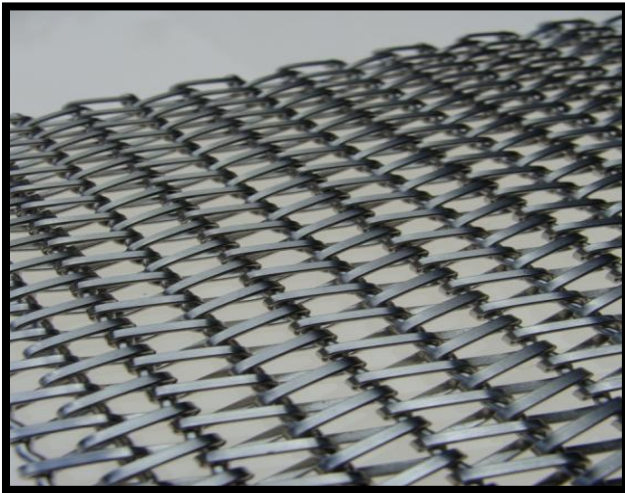

Profile	Transit 610
Material	S/S T316, T304, Galv
Finish	Mill
Max. Width	3000mm
Max Length	As per Application
Open Area	<5%
Weight	22.7 kg/m ² (S/S)
Stock Status	Custom Made
Type	Flexible
Wire Dia	1.6mm
Aperture	N/A
Form	Roll



* Typical Architectural Installation

Applications:

Building Facades, Curtains, Ceilings

Attachment Methods:

Locker Group Fixing systems; including Angle, Cap, Flat Bar or Tensioned. See website for more details.

Extra Notes:

Dimensions are nominal

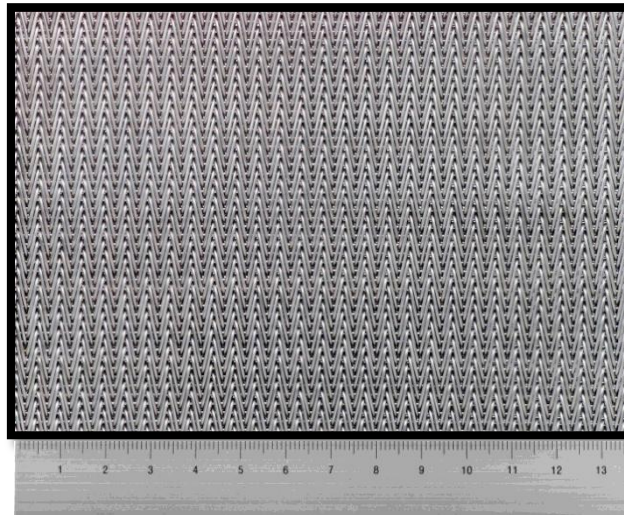

Profile	Transit F360
Material	S/S T316
Finish	Mill
Max. Width	5000mm
Max Length	As per Application
Open Area	61%
Weight	10.8 kg/m ²
Stock Status	Custom Made
Type	Flexible
Wire Dia	6.0/1.0 Ribbon
Aperture	19.4 x 65mm
Form	Roll



* Typical Architectural Installation

Applications:

Building Facades, Features

Attachment Methods:

Locker Group Fixing systems; including Angle, Cap, Flat Bar or Tensioned. See website for more details.

Extra Notes:

Dimensions are nominal

