

EXXEN

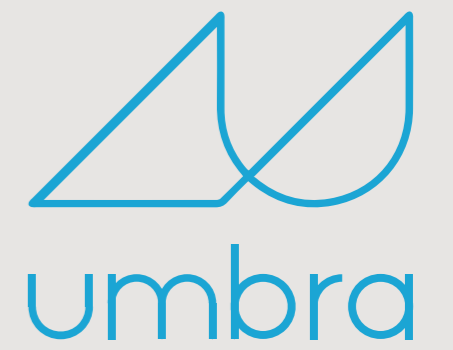

OUTDOOR  
LIVING

## EXXEN

### Perfect fusion of functionality, redefinition of outdoor living areas

Exxen is a high-end scissors bioclimatic aluminum pergola system that performs the most desired function in outdoor living spaces with its fully retractable feature.

It is designed to enhance your exteriors considerably to enable absolute protection and more relaxing time for any kind of outdoor living areas. The system is uniquely flexible and modular custom built to be adapted various types of large application areas such as restaurants, terraces, balconies either private or commercial with its distinguished design.

System enables you to make shadow control thanks to a simple opening and closing system with automated pivoting louvres that provides natural air flow effect and exceptional quality of outdoor life in the open air.

Thanks to its retraction feature Exxen allows you to see the open sky clearly and helps you benefit from daylight at the maximum level. It is extremely suitable for using your outdoor living space in all seasons and contributes to preserving your stylish line by showing an aesthetic harmony with other complementary products.

Individual modules can be custom made in your specified finish up to 7m wide and 9m projection with flexible integration solution between existing structures with an operable architecture. Also several modules can be linked to each other and even larger patio roof can be created by coupling multiple modules.

Along with the aluminum materials that make up the majority of the system, Exxen comes up with two different maximum size options. The system can be extended up to 9 meters projection and 4 meters of width or 8 meters projection and 4,5 meters of width dimensions, that is a practicable option especially for lengthwise applications. When it comes up with a maximum width of 7 meters, projection will be up to 6 meters and that's an efficient solution with covering of large commercial areas.

System is visually enriched with its elegant Hidden Led Stripe and RGB lighting options that can be adjusted according to current mood of user. Also optional insulation foam is available that enables heat and sound insulation.





■ Led Stripe Dimmer Lighting

■ RGB Led-Hidden Stripe Lighting



**Led Stripe Dimmer Lighting** illuminates all around the system and creates a warm atmosphere. Dimmable Soft Led Stripe lighting on sides within the structure provides intensity of day light or cool white options.

**RGB Led-Hidden Stripe Lighting** provides ultimate luxury by creating distinctive atmosphere in outdoor living areas with infinite colour options.



# Operations

Fully Closed

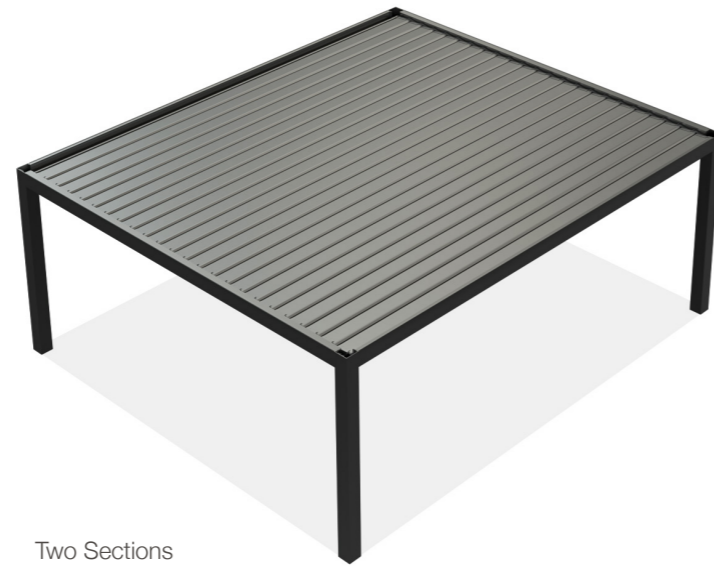

Fully Closed & Retracted

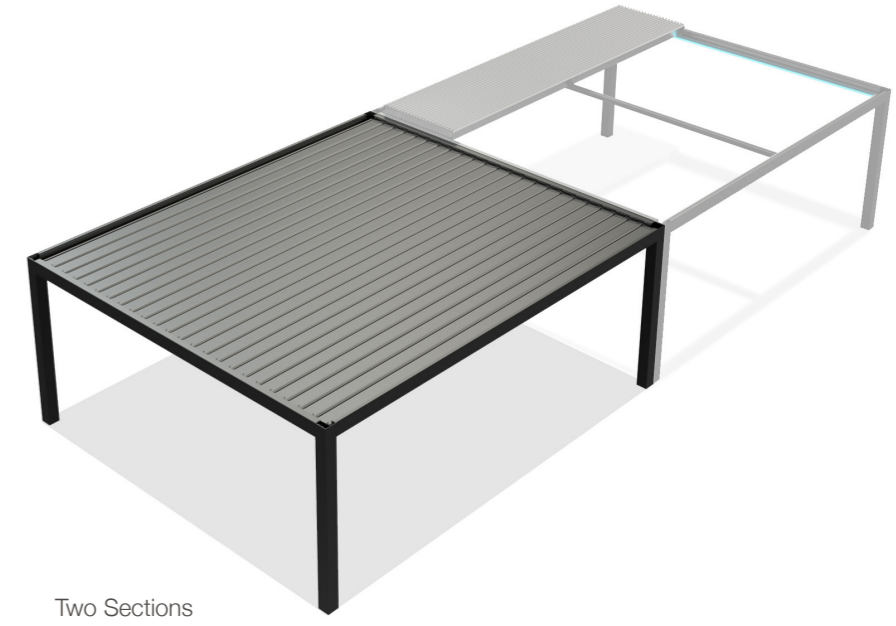
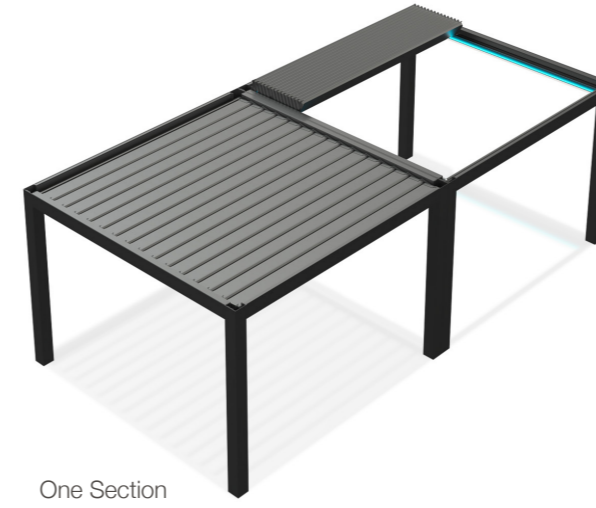

Retracted

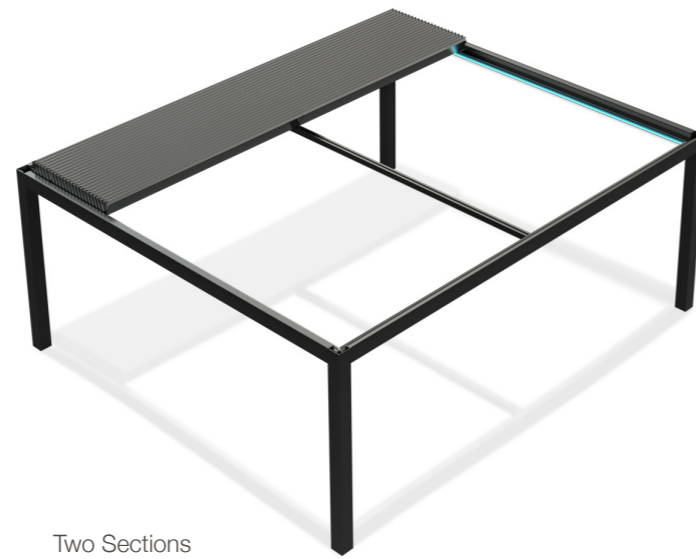
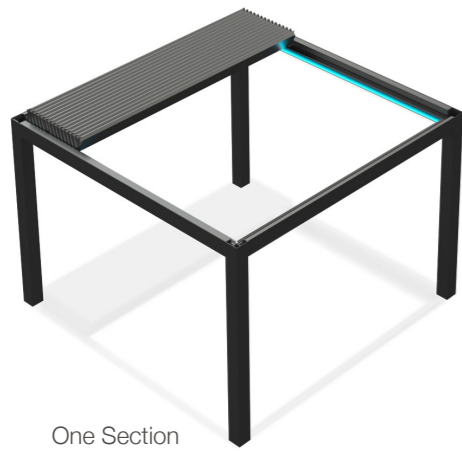

## Louvre Closing Direction

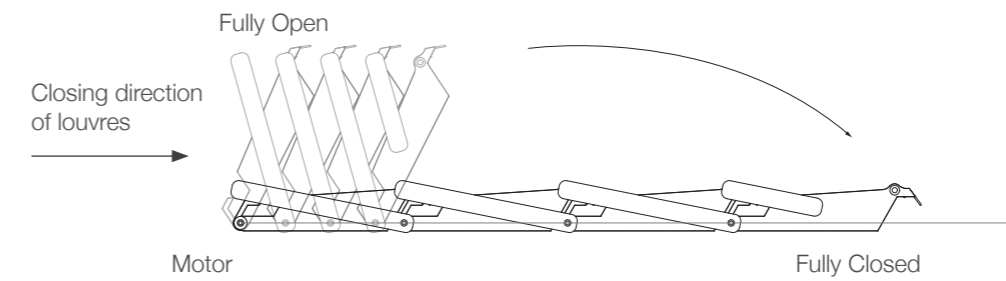

## Tilting Directions

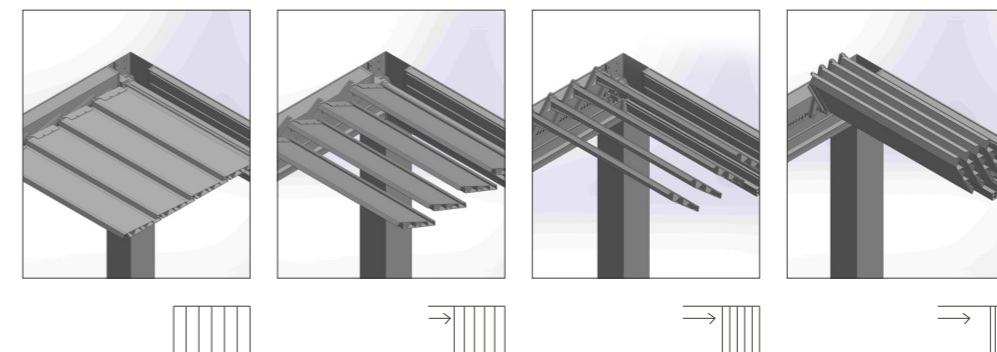



# EXXEN

Flexible installation methods are available with wall mounting and free standing installations and they can even be served as a roof assembled to existing frameworks.



Self Standing  
Single Module

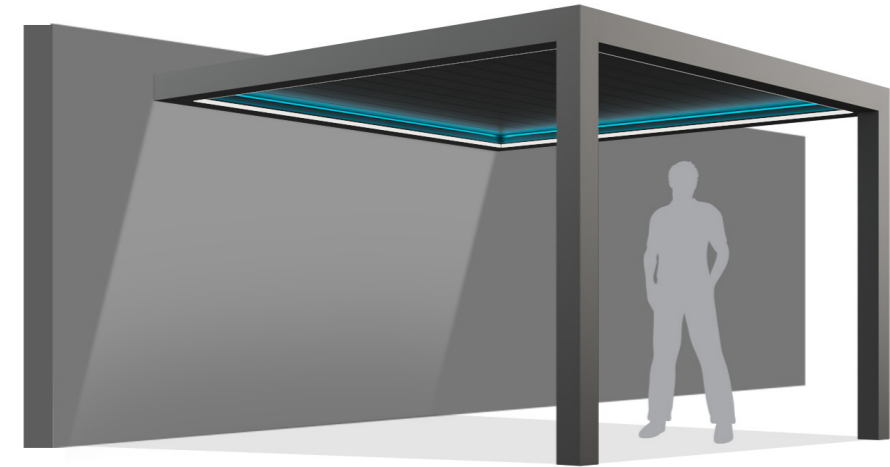

Wall Mounting  
Single Module

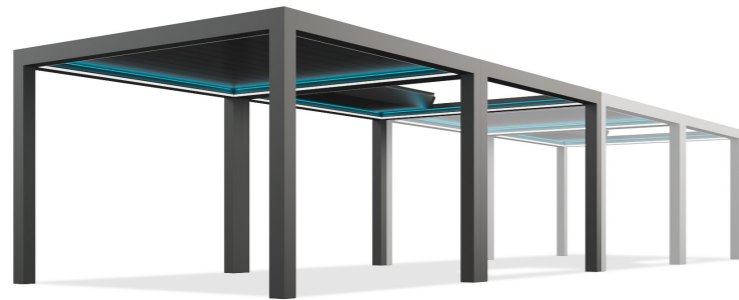

Self Standing  
Multiple Modules

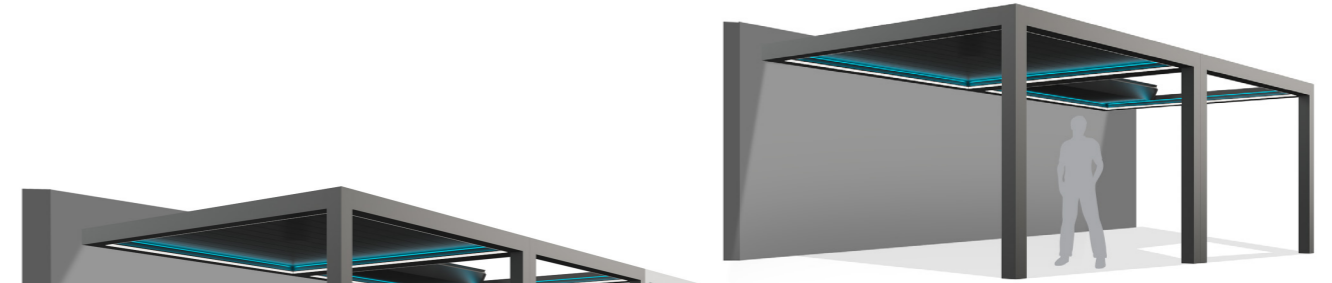

Wall Mounting  
Multiple Modules

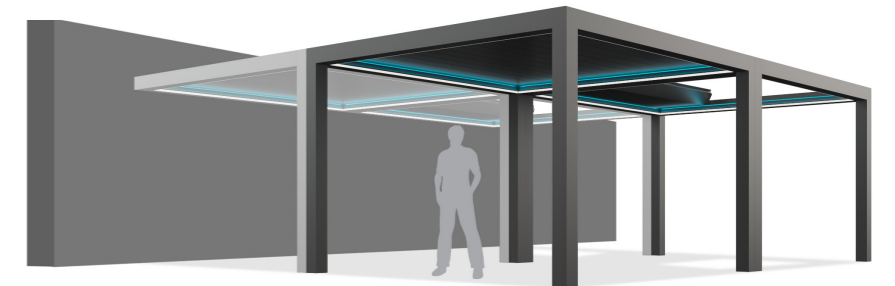
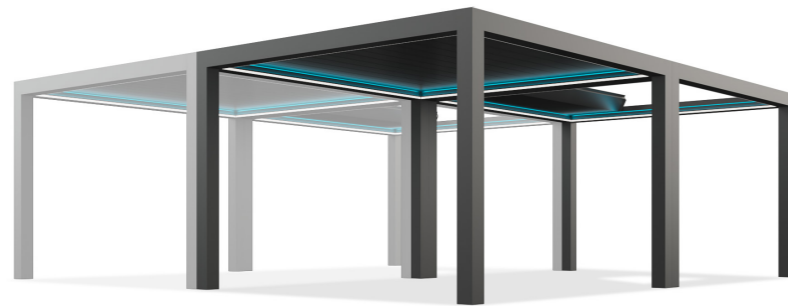
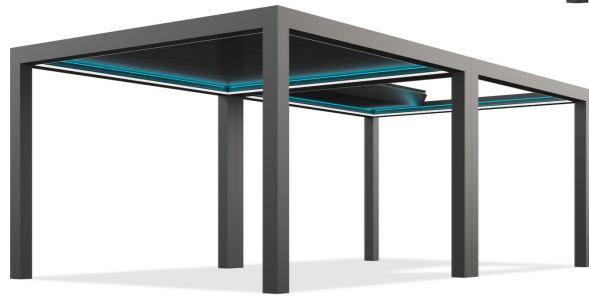



Blocked assembly for customized modules with a wide range of flexible combinations.

One Section

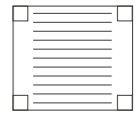

One Section  
 (w) Width 1200 mm < 4500 mm  
 (p) Projection 1780 mm < 9030 mm  
 (h) Height 3000 mm

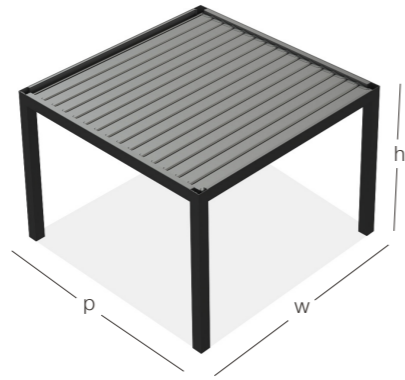

Two Sections

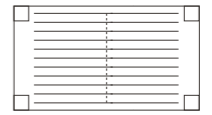

Two Sections  
 (w) Width 4501 mm < 7000 mm  
 (p) Projection 1780 mm < 6030 mm  
 (h) Height 3000 mm

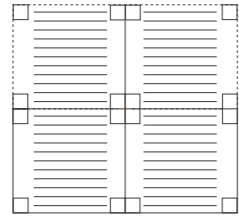
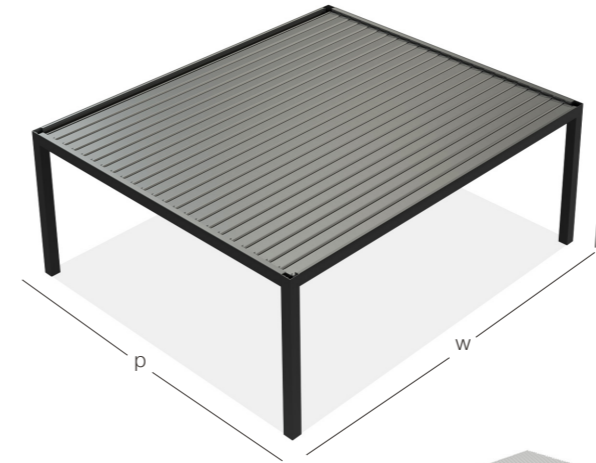

One Section  
 (w) Width 2400 mm < 9000 mm  
 (p) Projection 3560 mm < 18060 mm  
 (h) Height 3000 mm

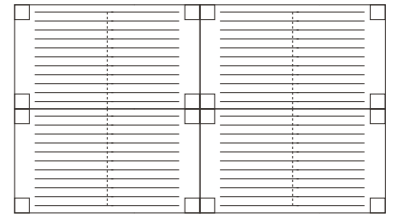
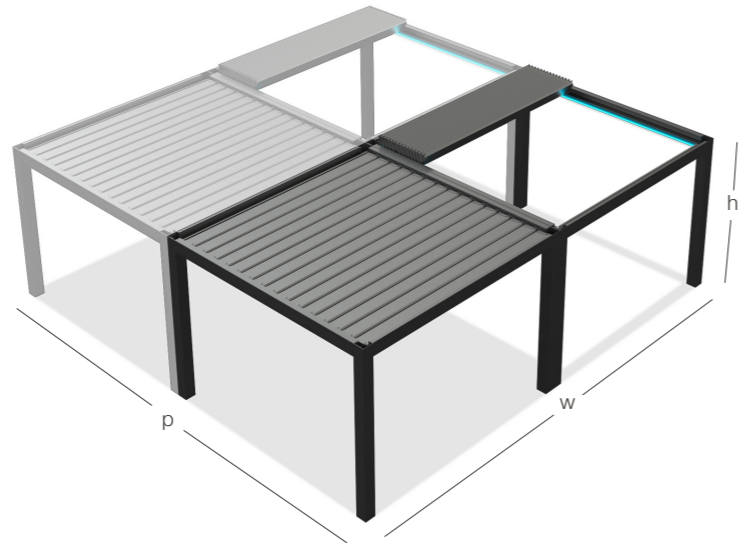

Two Sections  
 (w) Width 9002 mm < 14000 mm  
 (p) Projection 3560 mm < 12060 mm  
 (h) Height 3000 mm

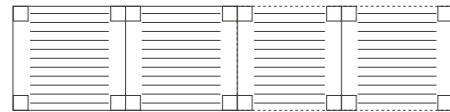
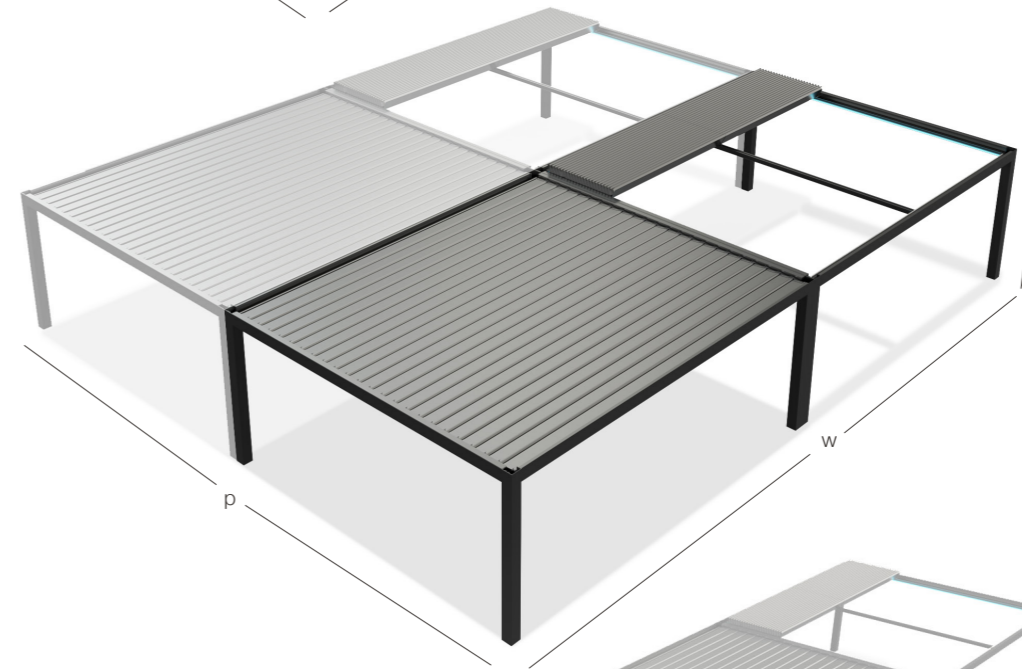

One Section  
 (w) Width 4800 mm < 18000 mm  
 (p) Projection 1780 mm < 9030 mm  
 (h) Height 3000 mm

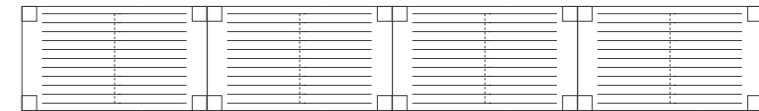
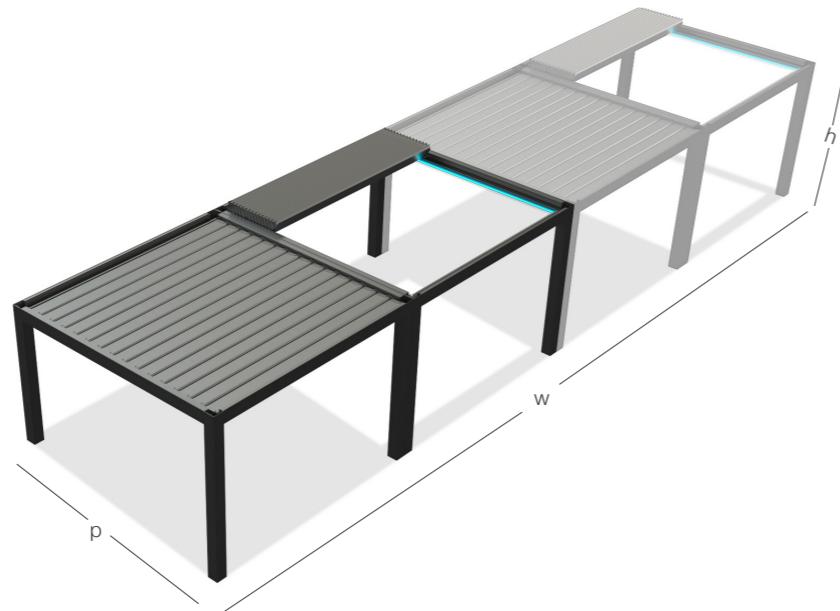

Two Sections  
 (w) Width 18004 mm < 28000 mm  
 (p) Projection 1780 mm < 6030 mm  
 (h) Height 3000 mm

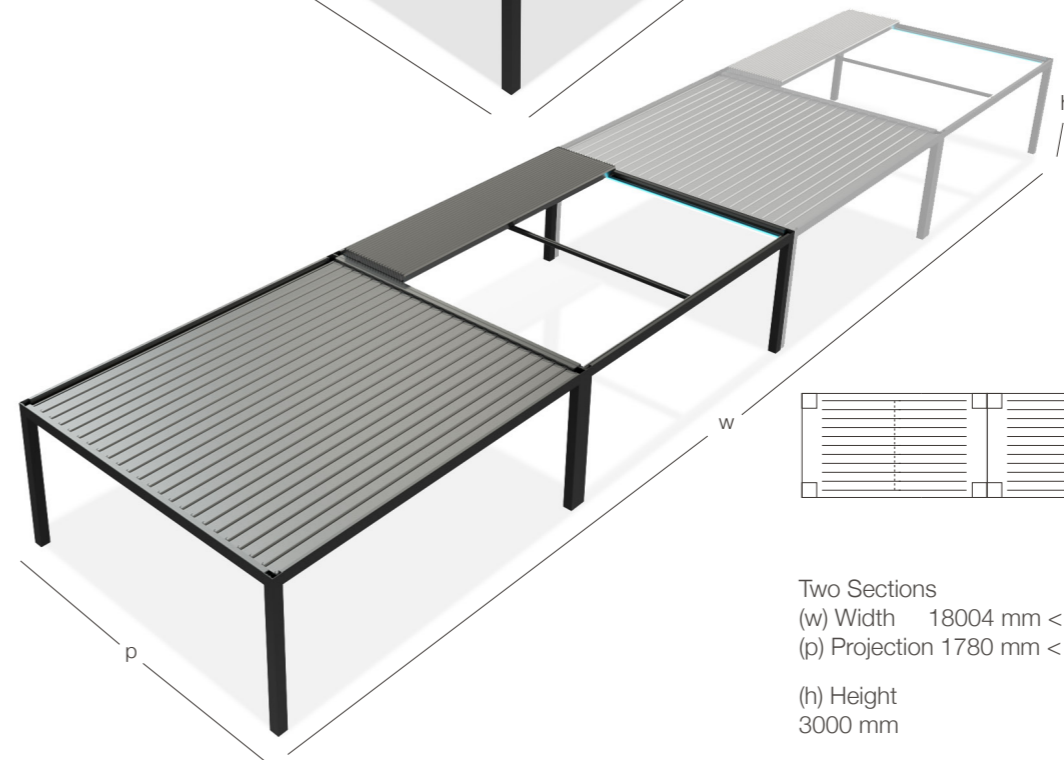



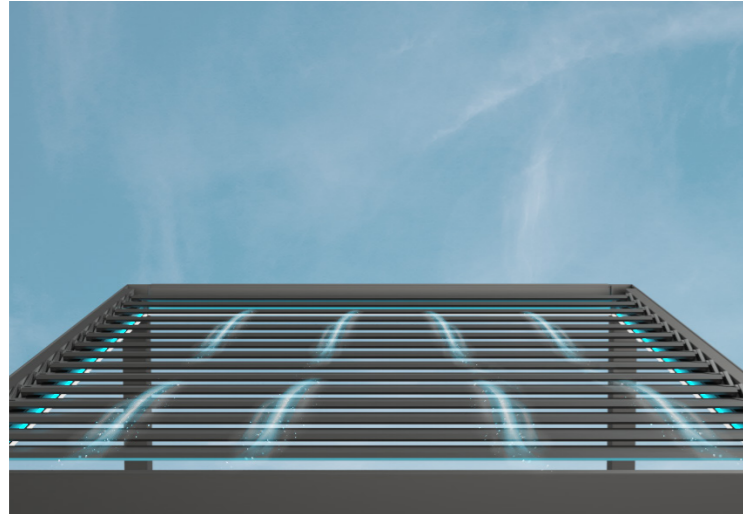

Slightly opening of louvres creates natural air flow for application areas.

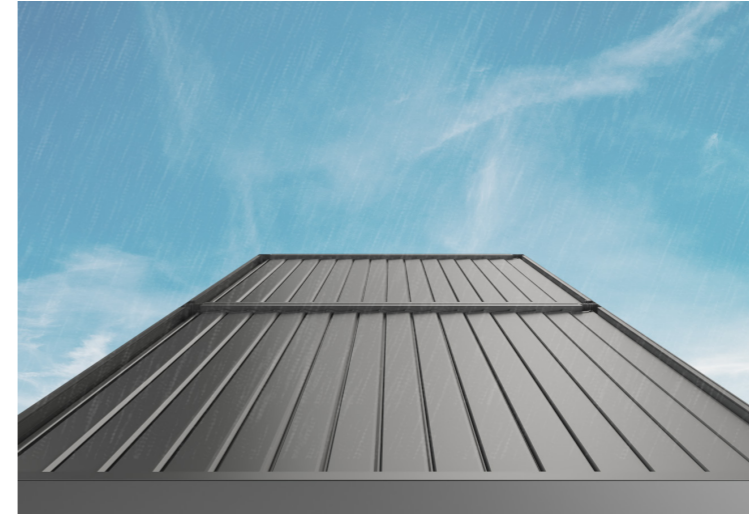

Ensuring waterproof coverage when louvres are in fully closed position.

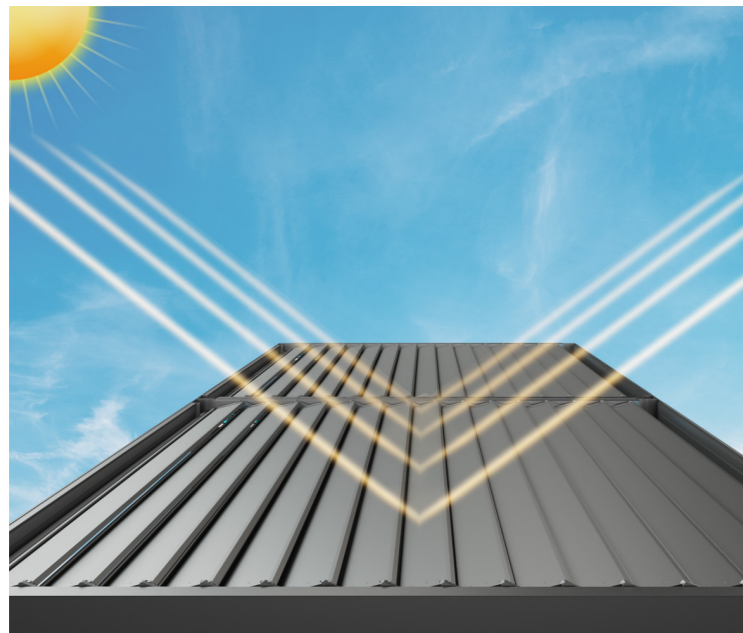

Protecting from sun exposure while ensuring air ventilation under the system .

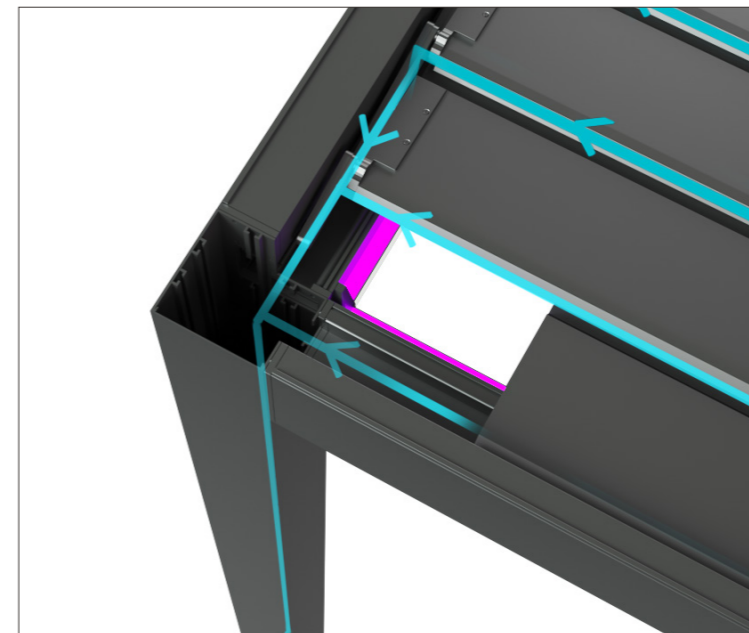

Each channel on louvres drain the water through four sided gutters connected with columns.



Functional seal entegrated on louvre channels provides maximum protection from water dripping.



Closures

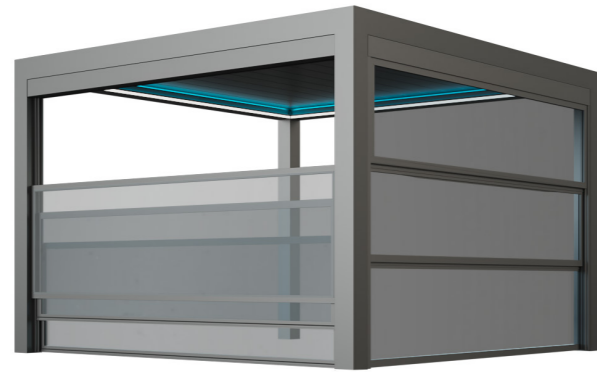

**Sapphire/Cycle Guillotine Glass System**  
System can be adapted to Exxen system and offers a maximum clear span that provides unobstructed view & minimalistic style. The system is operated by just the touch of button.



**Framee Sliding Glass System**  
Minimal line of Framee system is perfectly matching with modern architectural Exxen system by insulated fine-framed sliding glass panels. System offers a comfortable sliding with easy individual movement.

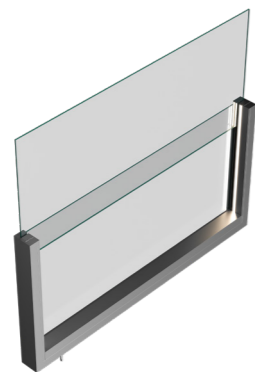

**Swind-Motorised Windbreaker System**  
Swind can be combined with also Exxen system and offers adequate wind breaking with the option of total transparency by incorporating the function of balustrade. Thanks to led stripe dimmer lighting integrated side frame the fixed panel assigns distinctive appeal. The system is modular and completely flexible as there are no limits in the horizontal direction that can be used to surround spaces of all types and sizes.

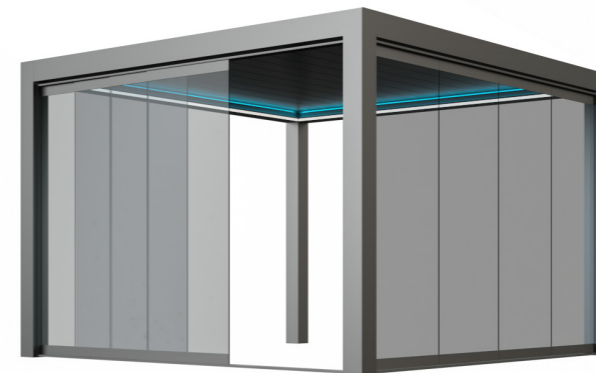

**Slidia Sliding Glass System**  
The combination of the sliding glass system with Exxen ensures efficacious protection from wind and rain. The aluminium frames which cover each glass panel provide maximum safety standards and practicality with elegance details.



**Violet Glass Balustrade System**  
The adaptability of Violet fixed balustrade glass with Exxen creates a stunning visual transparency without lacking of obstruction to lines of sight. The stylish lighting solution that is integrated underneath the glass highlights attractive aspect of the design by amplifying overall aesthetic of outdoors. Thanks to flexible and multiple modular implementations, system can be used to cover comprehensive areas without limitation in the horizontal direction.



**Vertex Zip Screen System**  
The minimalist, slimlane, contemporary design of the zip system provides comfortable shade and protects against the UV rays. The system includes motorised aluminium structure, entirely powder-coated with stainless steel bolts and screws.



**Wallfix Fixed Side Enclosure**  
The unique designed privacy of Wallfix side enclosure can be combined with Exxen system to optimise outdoor living areas visually.



Overview

Operations

⇌ Retractable



Technical Details



Lighting Options

Led Stripe Dimmer Lighting

Cool White

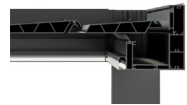

Day Light

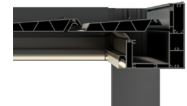

RGB Led-Hidden Stripe Lighting

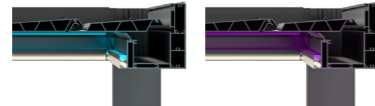
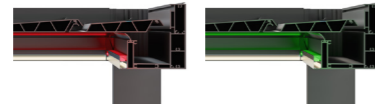

Optional Insulation Foam



Edge Cover Profile

With



Without



Installation Types

Self Standing Single Module



Self Standing Multiple Modules



Wall Mounting Single Module

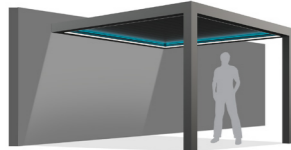

Wall Mounting Multiple Modules

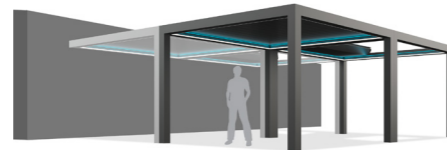
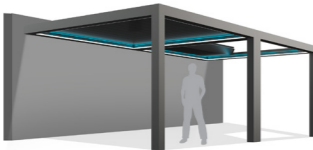

Sensors

Rain Sensor

Wind Sensor

Sun Sensor

Wind&Sun Sensor

Closures

Sapphire& Cycle



Swind



Violet



Framee



Slidia

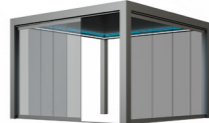

Vertex



Wallfix



Max. width for single module	4500 mm (One Section) / 7000 mm (Two Sections)
Max. projection single module	9030 mm (One Section) / 6030 mm (Two Sections)
Rafter profile dimension	180x200 mm
Gutter profile dimension	180x200 mm
Post dimension	180x180 mm
Louvre dimension	237 mm
Louvre quantity in max. size	31 pcs
Louvre can be tilted up to	70°
Louvres parking area	23%

Automation	included
Control unit	included
Led Stripe Dimmer lighting	optional
RGB Led - Hidden Stripe lighting	optional
Insulation foam	optional
Edge Cover	optional
Flange	optional
Rain Sensor	optional
Wind Sensor	optional
Sun Sensor	optional
Wind&Sun Sensor	optional



# ALUMINIUM

## basic



RAL 9016



RAL 1013



RAL 9006



RAL 7006



RAL 7016



RAL 9005

## exclusive



OGN35



OS561



OY395



OGN39



ON617



ON611

## texture

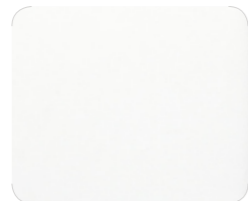

ST9010



ST9001



ST1013

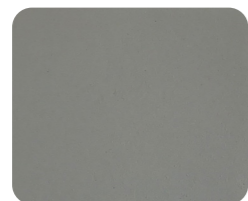

ST7039

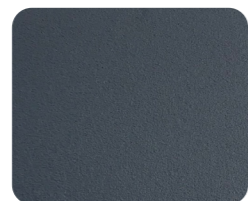

ST7016

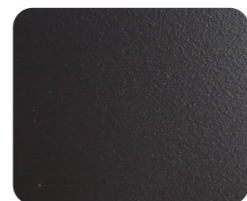

ST8019

The color and gloss level shown in this color swatch should be used only as a guide.  
All ral colors are available.

[www.umbraoutdoorliving.com.au](http://www.umbraoutdoorliving.com.au)

[info@umbraoutdoorliving.com.au](mailto:info@umbraoutdoorliving.com.au)

1300 820 387

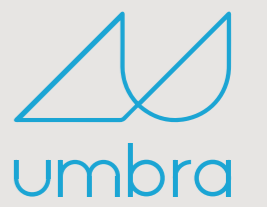

OUTDOOR  
LIVING

