



weather
defence™

rigid air barrier board



Disclaimer

Products manufactured and systems designed by Etex Australia Pty Ltd and branded Siniat, are produced in accordance with the Building Code of Australia and relevant Australian Standards. Information in this document is to be used as a guide only and is subject to project approval as many aspects of construction are not comprehensively covered. It is the responsibility of the project to determine if our products and systems are suitable for the intended application and they meet the relevant building code and project requirements. It is also the projects responsibility to ensure third party products have the appropriate certification with Siniat products and systems. Etex Australia Pty Ltd will not be held responsible for any claims resulting from the installation of its products or other associated products not in accordance with the recommendations of the manufacturer's technical literature or relevant Australian Standards, or for situations not covered by our certification reports.

Siniat technical information is regularly updated. To ensure this document is current with the latest information, visit:

www.siniat.com.au

or contact Siniat's Customer Service Centre on

1300 724 505

Warranty

Siniat products are covered by a comprehensive warranty.

Visit

www.siniat.com.au/warranty

Version 1
July 2023



about us

Siniat is one of the Etex Group's flagship commercial brands, and one of the leading global manufacturers of interior and exterior materials for drywall construction.

In Australia, Etex has Siniat manufacturing facilities located in Sydney, Melbourne, Bundaberg and Brisbane. Etex supplies Siniat branded plasterboard, compounds, cornice, steel profiles and associated products and systems to the Australian building industry through its national distribution network.

Siniat's comprehensive range of quality wall and ceiling lining products is developed with specific characteristics to enhance performance and provide fire, water, acoustic, impact and decorative solutions to all construction projects.

The Siniat team is committed to providing excellent technical service and sales support to help with innovative solutions for your next project.

contents

1 introduction	4
2 applications	5
3 components	6
joint sealing tapes	7
4 installation benefits	8
installation	8
external steel frame wall layout	9
general requirements	10
fixing	10
curving weather defence™	11
joint sealing	12
construction details	13
board inspection	16
5 case studies	17



introduction

Siniat **weather defence™** is a rigid air barrier which is used behind facade cladding systems to create a pressure equalised cavity. It has transformed building envelope construction and performance.

The design benefits it brings include:

- Compliant for facades requiring non-combustible construction
- Class 4 vapour permeable and can achieve outstanding building airtightness
- It is the only compliant rigid air barrier in Climate Zones 6, 7 & 8
- Easy to cut and shape, offering more options for design detailing
- Up to 50% quicker to install than cement based boards or metal sheets
- Makes the building weathertight for internal trades, reducing the construction cycle
- Simply score and snap, no need for specialist cutting equipment or segregated areas
- No additional wall wrap may be needed
- **weather defence™** is water, weather and mould resistant and can be left **exposed on frame for up to 12 months**. It makes the building weathertight, allowing internal trades to start working earlier.



applications

Innovative technology

External sheathing board options have evolved. **weather defence™** is a rigid air barrier that is BCA compliant for non-combustible facades; a great alternative to cement based sheathing boards. It's excellent vapour permeability means it is suitable for cold climates, or for accelerating construction by enclosing the building early.

weather defence™ is designed to be installed on:

- Lightweight steel stud framing
- Modular buildings
- Timber frame buildings

weather defence™ installations can achieve airtightness targets that contribute to a building's energy efficiency and allow any glasswool insulation in the cavity to perform as intended by avoiding wind washing.

It has a fully recyclable gypsum core that is low in embodied carbon and that produces no silica dust during installation. **weather defence™** also improves thermal and acoustic performance.

components

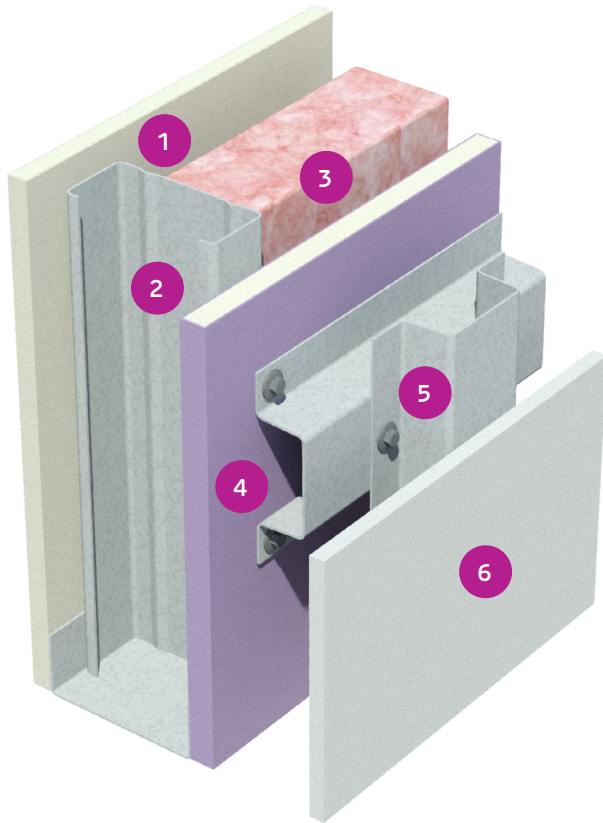

- 1 Internal wall lining
- 2 Steel framing
- 3 Insulation
- 4 weather defence™ rigid air barrier
- 5 Cladding support framing system
- 6 Cladding

Name	Thickness (mm)	Width (mm)	Length (mm)	Weight (kg/m ²)	Properties
weather defence™	13	1200	2400	11.7	

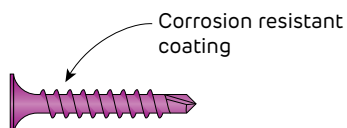

Product Code	Box screw
4084645	1000 screws

FIGURE 2 6g x 38mm Weather Defence Screw
Fine thread drill point screw

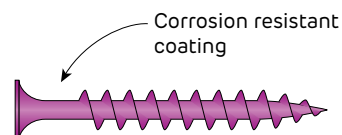

Product Code	Box screw
4084646	1000 screws

FIGURE 3 6g x 42mm Weather Defence Screw
Coarse thread needle point screw

joint sealing tapes



Product Code	Length	Width
13206	30 m	60 mm
13280	30 m	100 mm
14891	30 m	150 mm

FIGURE 4 Pro Clima Tescon Extora®
Flashing Tape - (Supplied by Pro Clima)



Product Code	Length	Width
14152	20 m	150 mm
14156	20 m	200 mm

FIGURE 5 Pro Clima Tescon Extoseal®
Sill Tape - (Supplied by Pro Clima)



Product Code	Length	Width
16849	30 m	38 mm

FIGURE 6 Pro Clima Tescon® WS
Wet Seal Connection Tape - (Supplied by Pro Clima)

Tape width	Application
60 mm	Jointing
100 mm	Vertical control joints, internal and external corners, sides and top of openings
150 mm	92 mm stud frame sills
200 mm	150 mm stud frame sills
38 mm	For sealant around external openings

installation benefits

Why **weather defence™** is significantly quicker to install than cement based boards or metal sheeting:

- It can be scored and snapped with a utility knife
- No transportation time to a separate cutting area
- It can replace wall wrap
- Fine details are easily cut using a key hole saw or power tools
- Can be left exposed on frame for up to twelve months

Manual handling and health & safety benefits

When cutting, cement boards or metal sheets may require the use of power tools. In contrast, **weather defence™** just requires a utility knife.

Dust hazards and cutting areas

Cutting cement boards is likely to generate large quantities of very fine dust, which requires effective ventilation – often a cutting area some distance from the installation area. In contrast, the score and snap method used for **weather defence™** generates minimal dust levels and does not require a separate cutting area.

installation

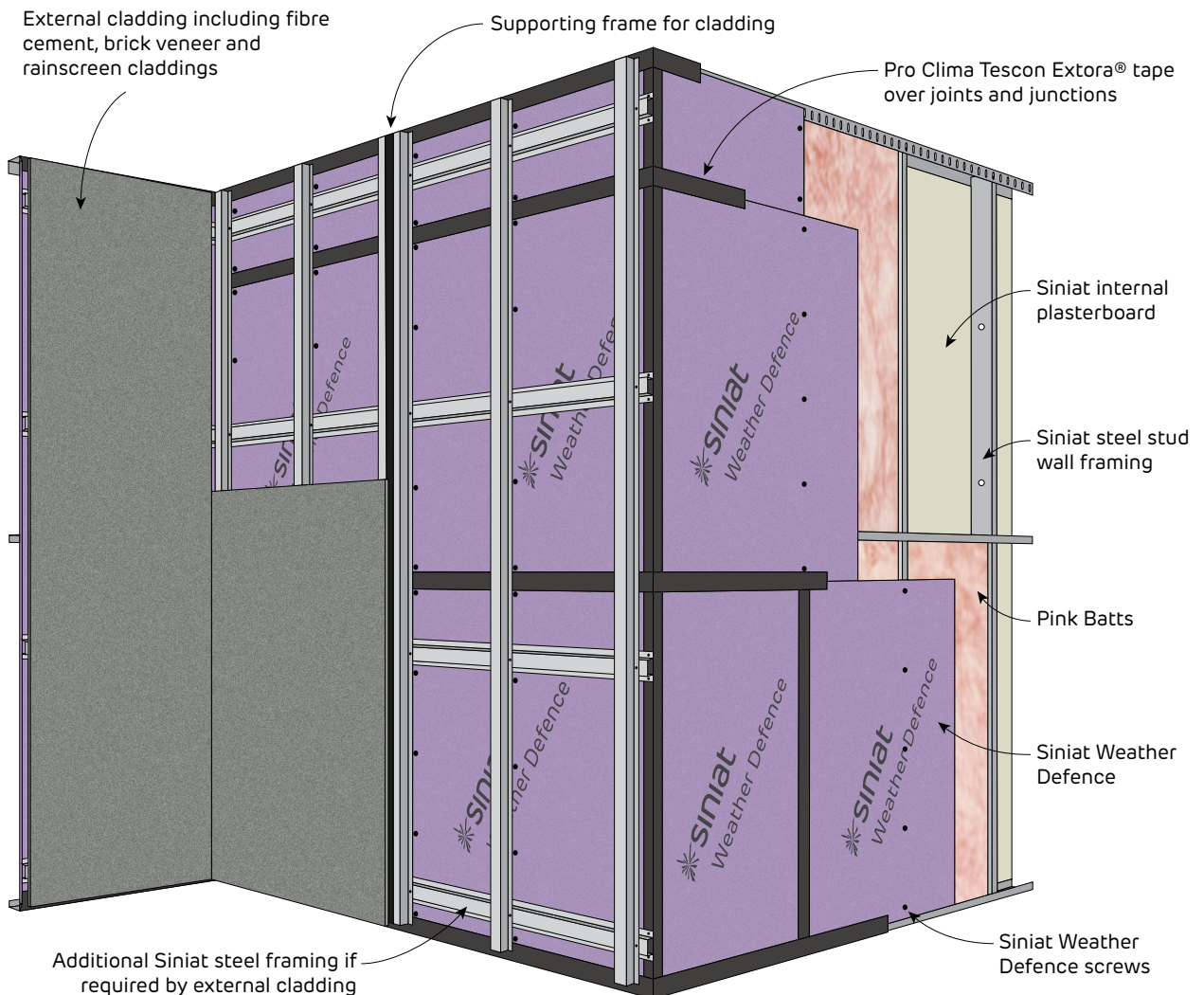

FIGURE 7 Typical Weather Defence Installation
Perspective

external steel frame wall layout

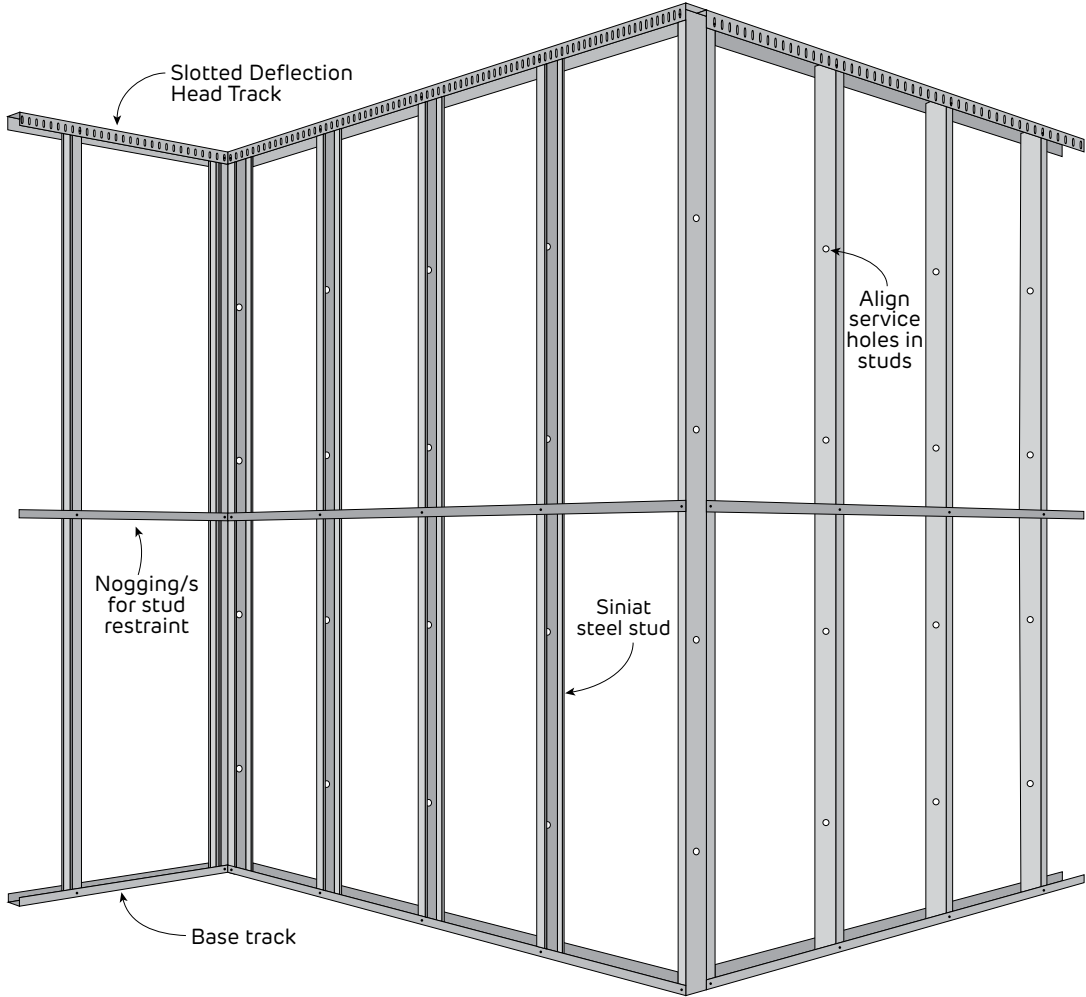

FIGURE 8 Typical External Steel Frame Wall Layout
Perspective

general requirements

<p>Install control joints in weather defence™:</p> <ul style="list-style-type: none"> > At every intermediate slab level > At all control joints in the structure > At any change in the substrate
<p>Attach top hats or other cladding framing through weather defence™ to the structural frame</p>
<p>Wall anchors or screws must not be used to fix framing or other items to weather defence™; use stud, noggings or blocking</p>
<p>Do not install weather defence™ where it may become immersed in water</p>

fixing

<p>Drive screws to just below the sheet surface, taking care not to break the fleece liner. For over-driven screws, install another screw 20mm away. Leave or remove the over-driven screw and patch with tape.</p>
<p>Use the 'Screw Only Method'. Stud adhesive is not permitted.</p>

Table 1 Screw Type for the Installation of Weather Defence to Steel

Plasterboard Thickness	1st Layer
13mm	6g x 38mm fine thread drill point Weather Defence screw

Table 2 Screw Type for the Installation of Weather Defence to Timber

Plasterboard Thickness	1st Layer
13mm	6g x 42mm coarse thread needle point Weather Defence screw

FIGURE 9 1 Layer - Horizontal
Screw Only Method

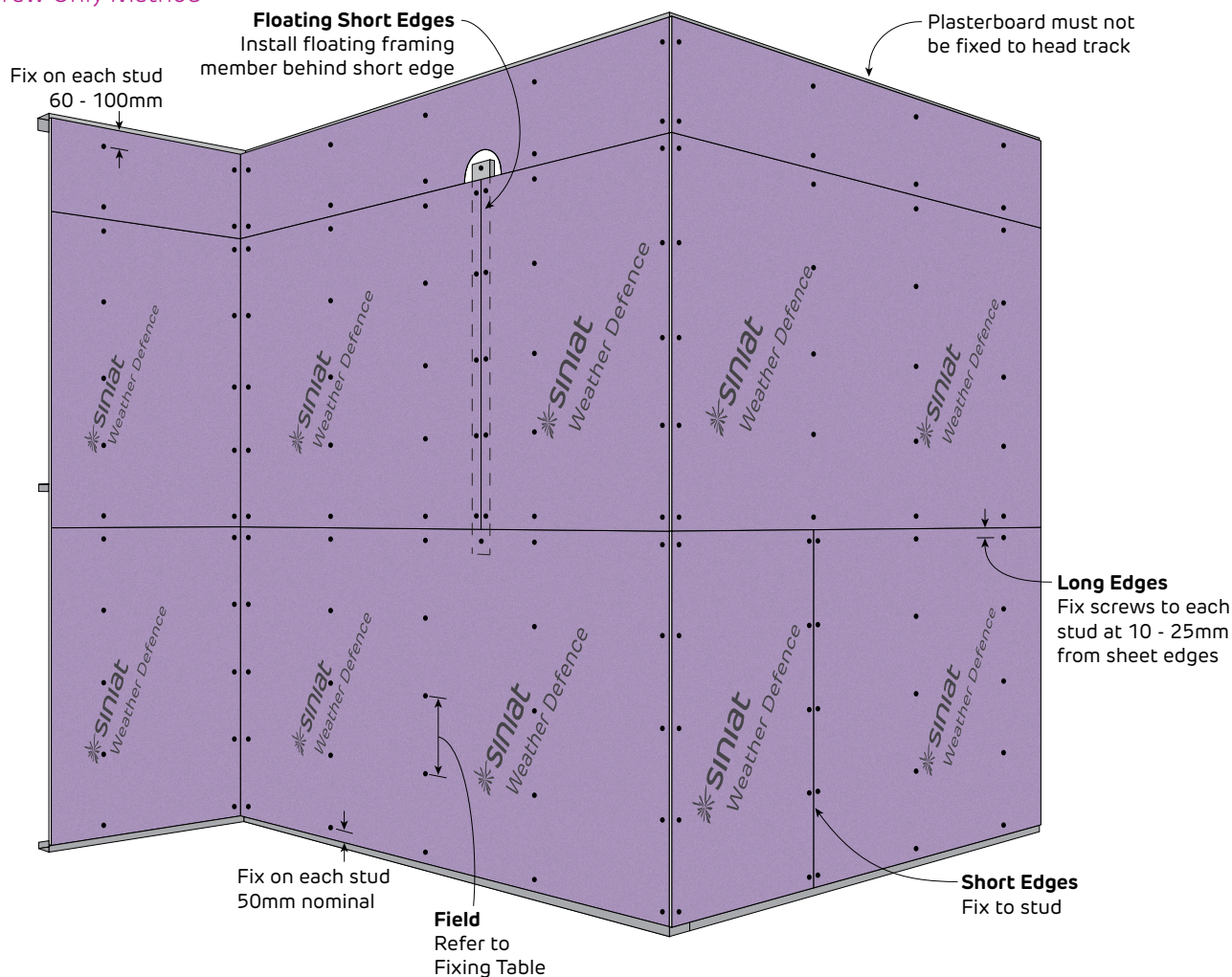

Maximum Ultimate Limit State Wind Load Table (kPa)

Fixing Pattern	Maximum Wall Stud Spacing			
	600mm	450mm	400mm	300mm
S S S S S (5)	1.31	1.74	1.96	2.62
S S S S S S (6)	1.64	2.18	2.46	3.28
S S S S S S S (7)	1.95	2.62	2.95	3.93
S S S S S S S S (8)	1.95	3.08	3.47	4.63

S = Screw. Screws evenly spaced along sheet width and located 10 - 50mm from sheet edges.

1. Calculations do not include the framing which must be independently designed to suit the desired loads.
2. If higher wind pressures are expected, please contact Siniat for specific design.

curving weather defence™

Fix flat plate to studs corresponding with all horizontal board joints
Fit weather defence™ board horizontally across studs and install in a 'brick bond' pattern
Refer to screw table for maximum screw spacing depending on the wind pressure
Use Pro Clima Tescon Extora range of tapes to seal joints

joint sealing

Applying Tescon Extora range of tapes from Pro Clima:

Tape system is limited to an exposure period of no longer than 6 months
Tape may be applied at any time within the twelve months exposure period following weather defence™ installation. Note that joints without tape may allow some water penetration
weather defence™ surface must be generally clean, dry and free of oil, dust and other particles or chemicals that could cause poor adhesion – significant contamination may impair adhesion
Install weather defence™ boards with a 0–2mm gap
Peel backing paper from the tape as the operation progresses
Apply with joint running along the centre of the tape – this will usually cover screw fixings
Apply without wrinkles or excessive tension in the tape. Firmly press, and smooth against weather defence™ , running over the tape with the applicator paddle to ensure adhesion
Minimise the number of pieces of tape used to reduce the risk of gaps. Overlap tapes by 50mm minimum where multiple pieces have to be used. Ensure overlaps are pressed firmly against board and fully sealed
Seal horizontal joints first and run tapes for vertical joints over the top of the horizontal tape
Patch tapes with additional 150mm pieces perpendicular to the original tape, rather than removing strips from weather defence™ and risking damage to the substrate
Where high levels of rain tightness are required it is advised to use a hose to identify holes or gaps
Tape may be applied between 5°C and 40°C.

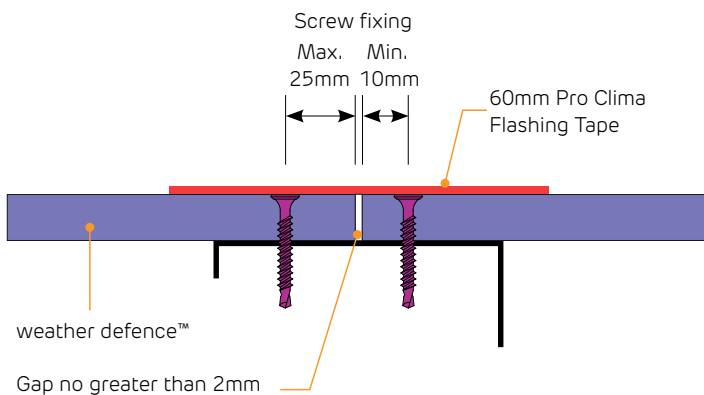

FIGURE 10 Edge distance for board fixing

construction details

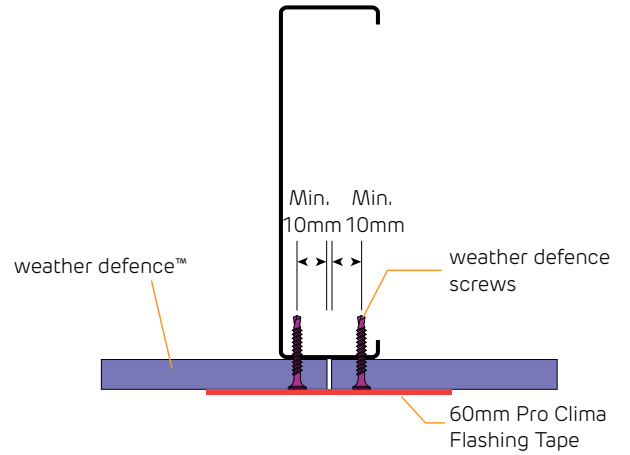

FIGURE 11 Typical joint detail

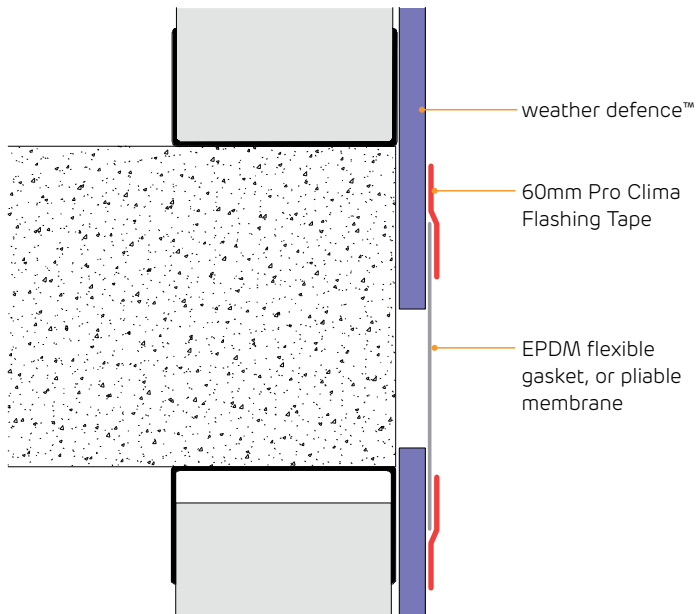

FIGURE 12 Horizontal control joint detail

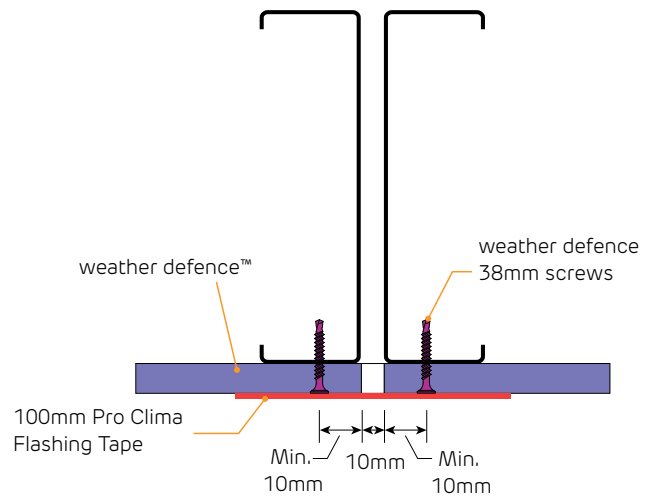

FIGURE 13 Vertical control joint detail

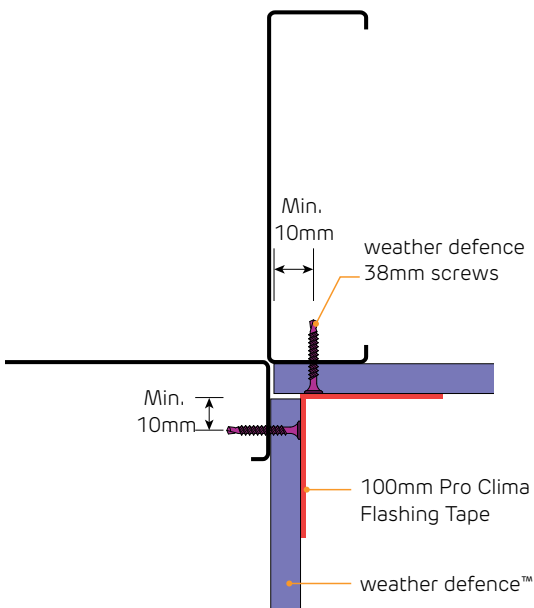

FIGURE 14 Internal corner detail

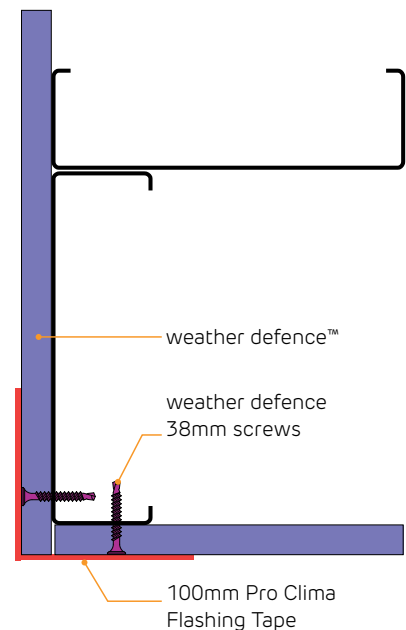

FIGURE 15 External corner detail

FIGURE 16 Isometric view of window/meter box opening - tape application

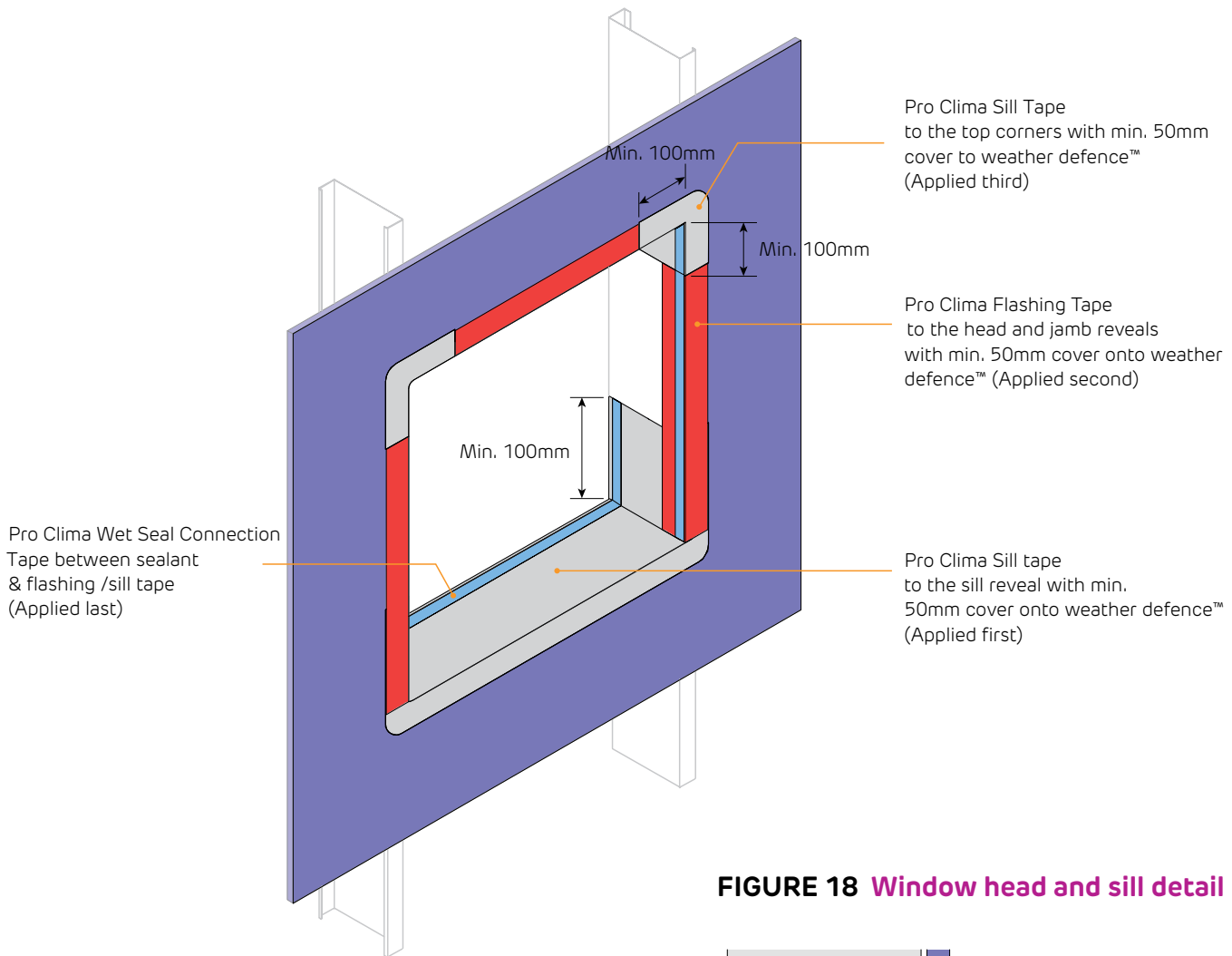

FIGURE 18 Window head and sill detail

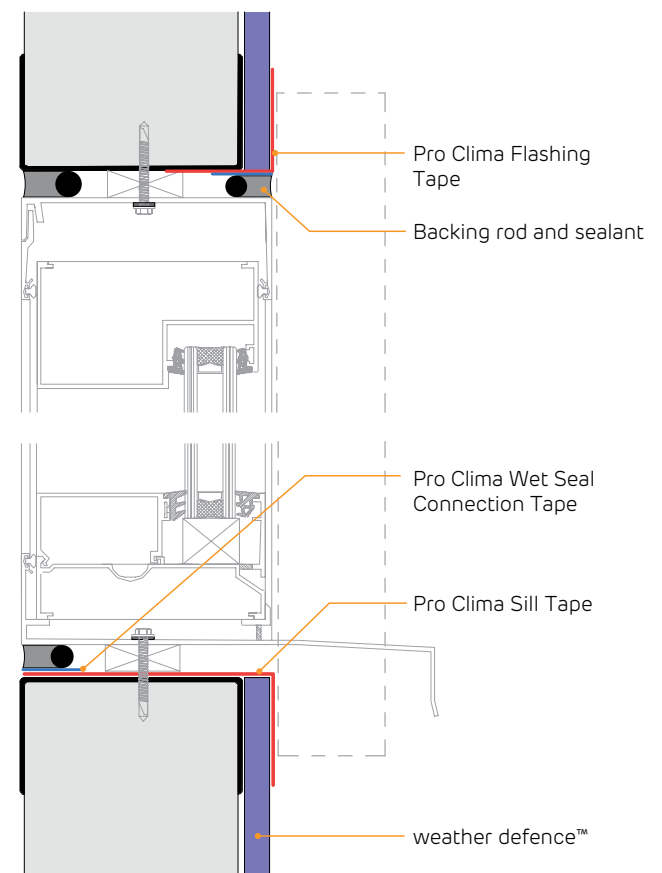

FIGURE 17 Window jamb detail

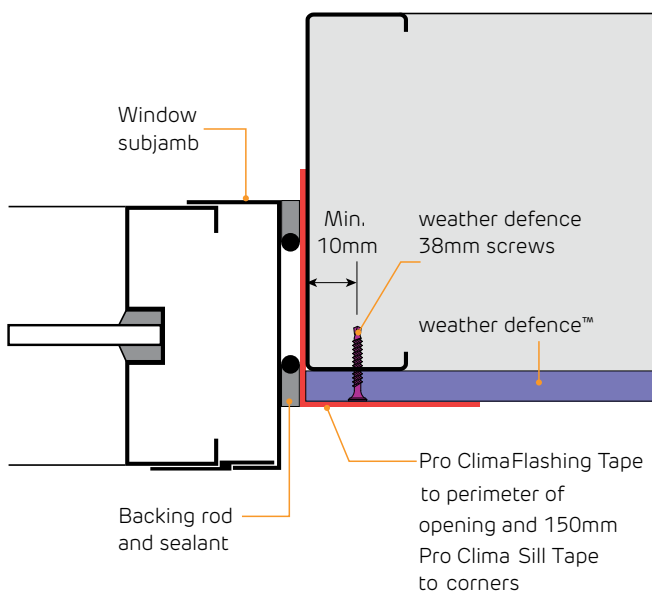

FIGURE 19 Wall base detail 2

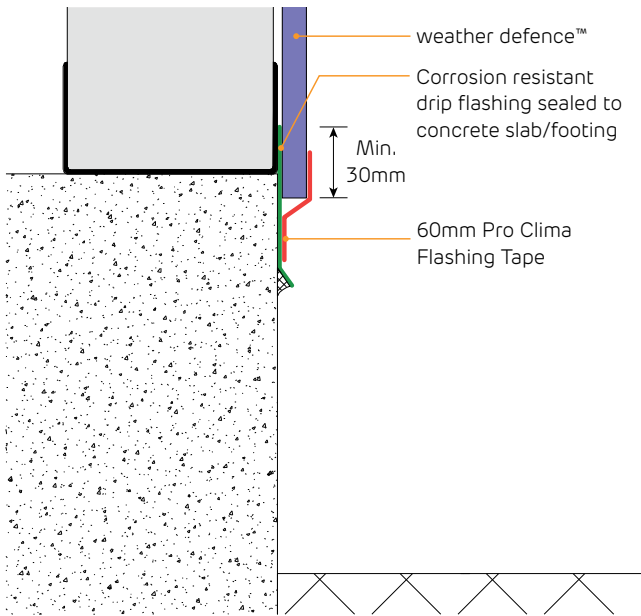

FIGURE 20 Exposed slab junction detail

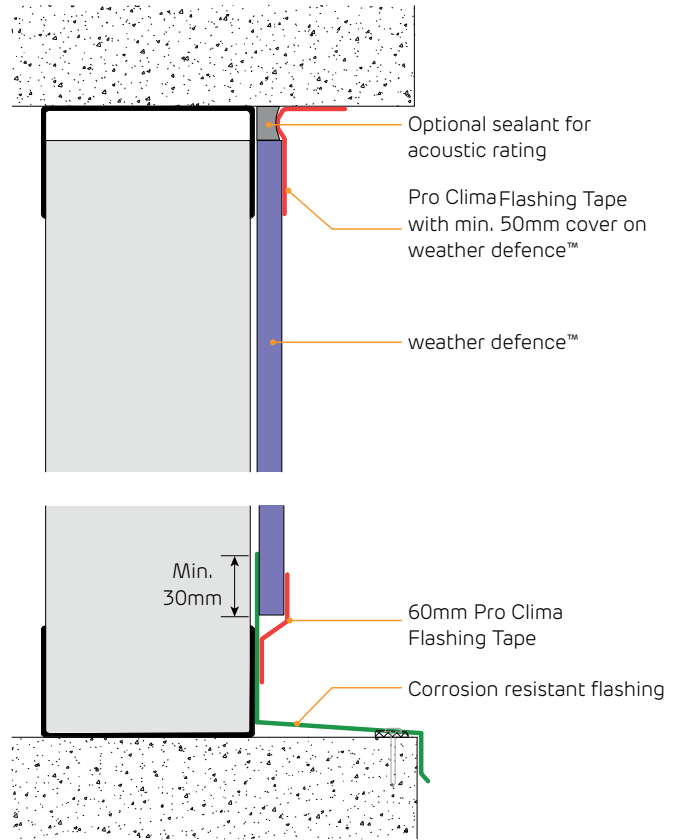

FIGURE 21 Wall base detail - balcony

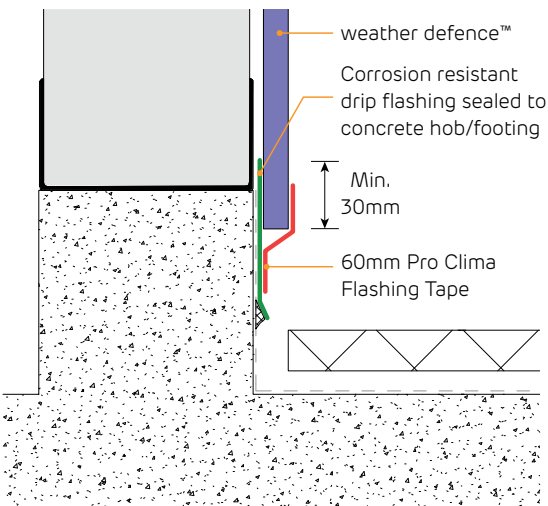

FIGURE 22 Parapet detail

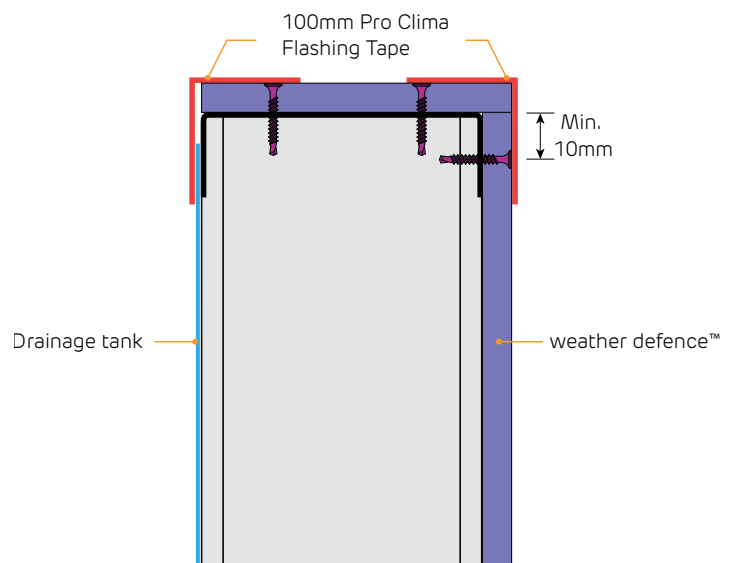
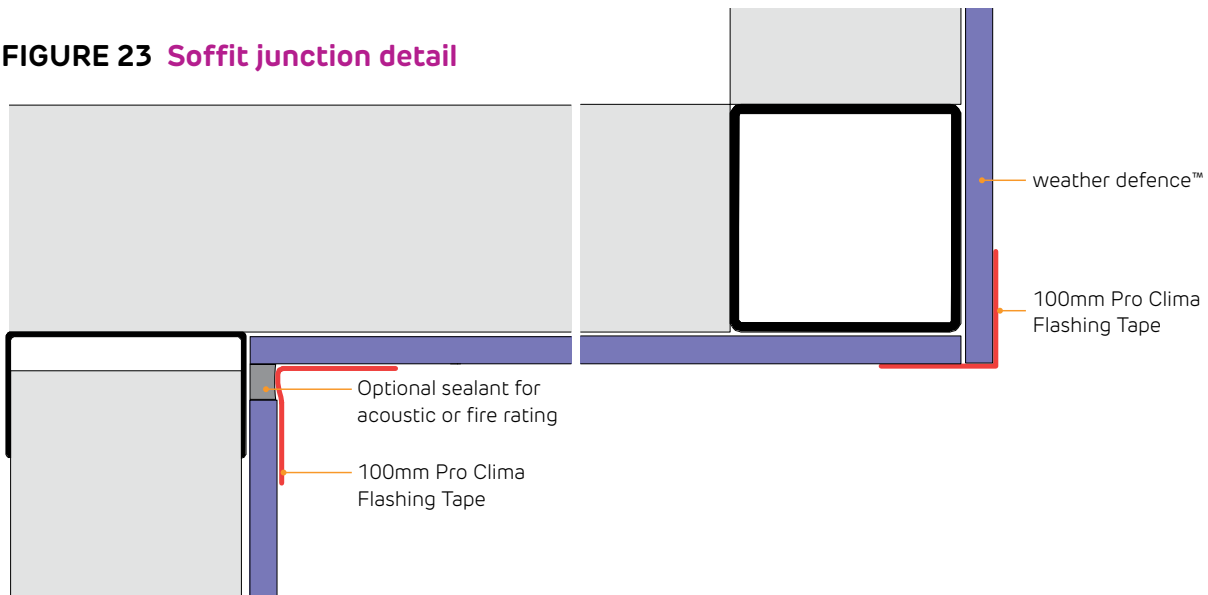

FIGURE 23 Soffit junction detail



board inspection

Inspect **weather defence™** boards for any damage prior to closing off the sheathing layer and after extreme weather.

Fixing damaged boards:

<p>Minor damage to weather defence™ can be repaired with the application of suitably sized pieces of Pro Clima Tescon Extora or Extoseal tapes that overlap the damage by 50mm minimum in all directions</p>
<p>More extensive damage may require the replacement of the damaged section with a piece of weather defence™ board cut to size and Pro Clima Tescon Extora tape applied to all horizontal and vertical joints. Back all joints with framing and fix with Weather Defence screws at 100mm maximum spacing</p>

case studies

Park Sydney, Sydney

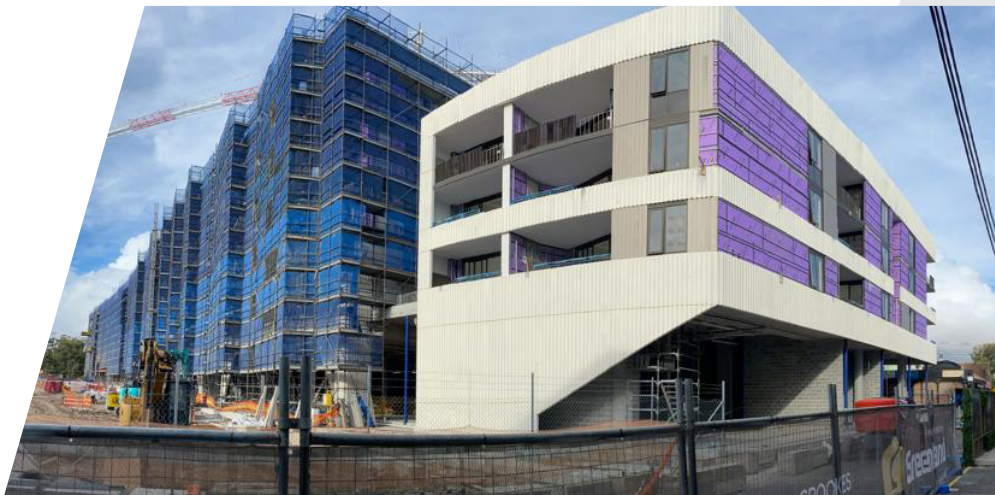

weather defence™ was selected as the site of this new apartment complex needed a rigid weather barrier for use behind a ventilated rainscreen capable of providing a high performance facade, whilst meeting all fire compliance requirements.

The use of **weather defence™** also provided an increased acoustic performance, over a pliable sarking membrane, whilst still being highly vapour permeable to control interstitial condensation risks.

Over 10,000m² of **weather defence™** was installed over the 3 blocks, allowing an earlier close-in of each building. This allowed internal trades to keep to project schedules, evening during large rain events.



Brookvale Public School, Sydney



Siniat **weather defence™** was used in conjunction with a rainscreen facade system from EQUITONE. The **weather defence™** provides a robust weathertight building envelope, whilst managing condensation risk by being highly vapour permeable.

Onsite teams were impressed by the performance of **weather defence™** during periods of heavy rain. It allowed the interior to stay dry, enabling internal trades to keep working. This would not have been possible without the installation of Siniat **weather defence™** early on in the build.



Heartlands Hospital, Birmingham - UK

Siniat's Weather Defence was used in a new Ambulatory Care and Diagnostics Centre (ACAD) in Birmingham's Heartlands Hospital. The project was challenging as construction continued in the pandemic and amidst strict lockdown measures in the UK.

The architect had originally specified Siniat systems for just three wall types in the ACAD, but during the build it became clear the requirement for drywall, passive fire and external protection was far greater than the original design. Working closely together, Kier and Siniat UK identified a further eight wall types that needed to be included in the specification.

This resulted in a combination of Siniat's products being specified, including **weather defence™** external sheathing.

The project's most challenging problem was presented by the number of building services that would be going through the ACAD Centre's walls. Hospitals are complex environments and require a large amount of ducting, pipework and cabling to run through the walls. This is more than those of a standard build which normally means more gaps in the walls, which can cause challenges as if these are not sealed properly - meaning they could enable smoke and flames to spread rapidly in the event of a fire.

The Siniat range of boards are more flexible than other similar products on the market which meant they were able to deal with the aperture openings. As a result, Siniat was able to offer an effective solution that worked around the services and ensured all requirements such as fire stopping were adhered to.

weather defence™ external sheathing provides a faster way to weathertight structures compared to traditional sheathing boards. This meant the ACAD was protected from the elements and allowed internal trades to start work before the facade was fully complete.





Etex Australia Pty Ltd
ABN 61 003 621 010

31 Military Road
Matraville NSW 2036

siniat.com.au

warranty

Siniat's products are guaranteed
by a comprehensive warranty.
For details visit siniat.com.au

customer service and
technical advice

AU 1300 724 505