



Axis Drape



Australia's Specialist Manufacturer of Blinds and Curtains
for Commercial and Multi-Residential Buildings

www.norfolkblinds.com.au



Axis Drape

Elegant curtaining system for commercial and residential applications

- Highly efficient hand drawn system for all types of medium weight draperies. Also available in cord drawn option.
- Quick installation with iSmart Klicki brackets for wall and ceiling applications.
- Bendable; it can be bent and reverse bent using a 10 or 20cm radius or continuously curved.
- Can be used for Wave Fold and Standard drapery systems.
- Maximum fabric weight: 8-15 kg per metre.
- Colours available: White & Black.
- Custom made to your requirements.

AVAILABLE COLOURS

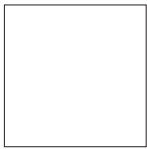

White



Black

TRACK OPTIONS

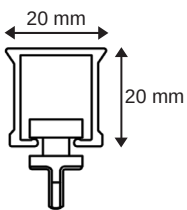

Heavy Duty

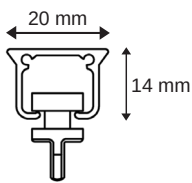

Standard

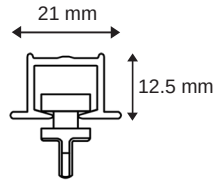

Recessed

CARRIER OPTIONS

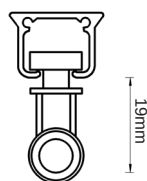

Easy Fold

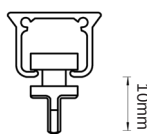

Ripple 100

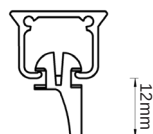

Standard



Axis Drape

BRACKET OPTIONS

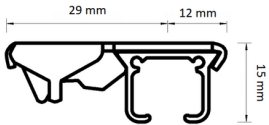

Top Fix

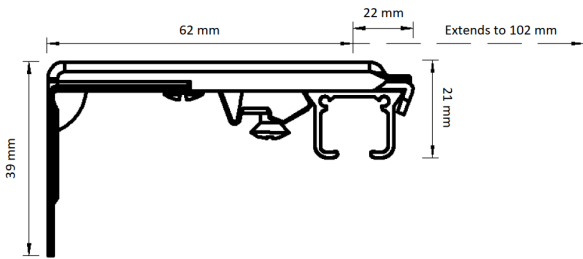

Standard Face Fix

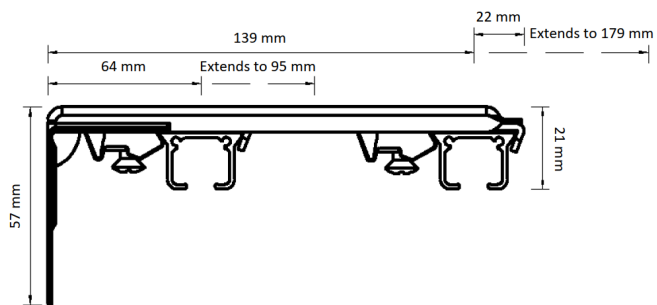

Dual Face Fix

