

BASIC

 CITTERIO®



Design:
Franco Mirenzi, Vittorio Parigi,
C.R.S. Citterio

Basic è una parete divisoria progettata per essere utilizzata in ambienti in cui la trasparenza, la luce e il design stanno alla base delle esigenze di funzionalità e di comfort ambientale.

Basic è una parete tutta vetrata senza montanti o dotata di moduli completamente ciechi da mm 60 o mm 105 di spessore. I moduli ciechi sono ispezionabili: al loro interno si possono collocare i cavi elettrici, telefonici, interruttori e impianti compatibili con le dimensioni dell'intercapedine.

Basic is a wall partitioning system design-engineered for surroundings where transparency, light and aesthetics are fundamental to functionality and comfort.

Basic wall panels are provided in entirely glazed - devoid of upright units - as well as entirely solid surface options and come in 60 mm or 105 mm widths. The blind modules are internally accessible. They can house electric wiring, telephone wires, switches and any other facility that can be fitted into the available interspacing.

Basic est une cloison conçue pour être utilisée dans des milieux où la transparence, la lumière et le design sont les éléments qui déterminent les exigences de fonctionnalité et de confort environnemental.

Basic est une cloison entièrement vitrée sans montants ou équipée de modules complètement aveugles de 60 ou 105 mm d'épaisseur. Les modules aveugles sont visitables ; on peut placer à l'intérieur des fils électriques, de téléphone, des interrupteurs et des équipements compatibles avec les dimensions de l'espace vide.

Basic es una pared divisoria proyectada para su uso en lugares donde la transparencia, la luz y el diseño son la base de las exigencias de funcionalidad y de comodidad ambiental.

Basic es una pared realizada completamente de vidrio sin montantes o dotada de módulos completamente ciegos de 60 ó 105 mm de espesor. Los módulos ciegos se pueden inspeccionar: En su interior se pueden colocar los cables eléctricos, telefónicos, los interruptores y las instalaciones compatibles con las dimensiones de la cruzía.





30

Parete divisoria vetrata completata da porte vetrate, con o senza intelaiatura in alluminio e porte cieche alte fino al soffitto.

Glazed wall partition panels complete with glass doors, with or without aluminium frame elements and solid, ceiling-high door options.

Cloison vitrée équipée de portes vitrées, avec ou sans cadre en aluminium, et portes aveugles allant jusqu'au plafond.

Pared divisoria de vidrio completada con puertas de vidrio, con o sin armazón de aluminio y puertas ciegas altas hasta el techo.

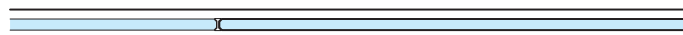
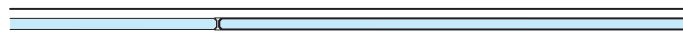
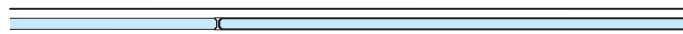

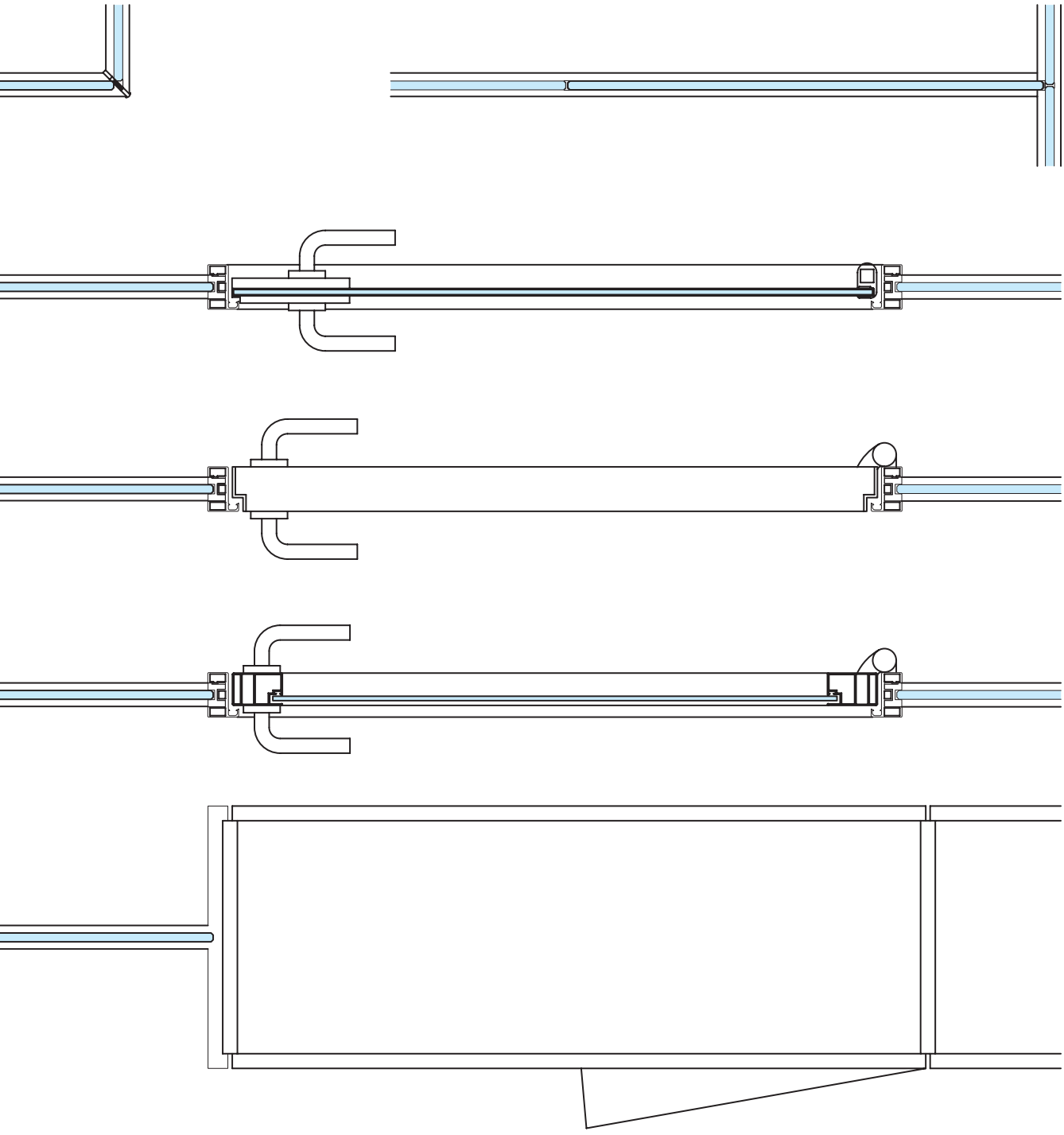









60

Parete divisoria vetrata con moduli ciechi spessi mm 60 e porte vetrate, con o senza intelaiatura in alluminio, e porte cieche alte fino al soffitto.

Glazed wall partition panels with solid, 60 mm thick modules and glass doors, with or without aluminium frame elements and solid, ceiling-high door options.

Cloison vitrée équipée de modules aveugles de 60 mm d'épaisseur et portes vitrées, avec ou sans cadre en aluminium, et portes aveugles allant jusqu'au plafond.

Pared divisoria de vidrio con módulos ciegos de 60 mm de espesor y puertas de vidrio, con o sin armazón de aluminio, y puertas ciegas altas hasta el techo.

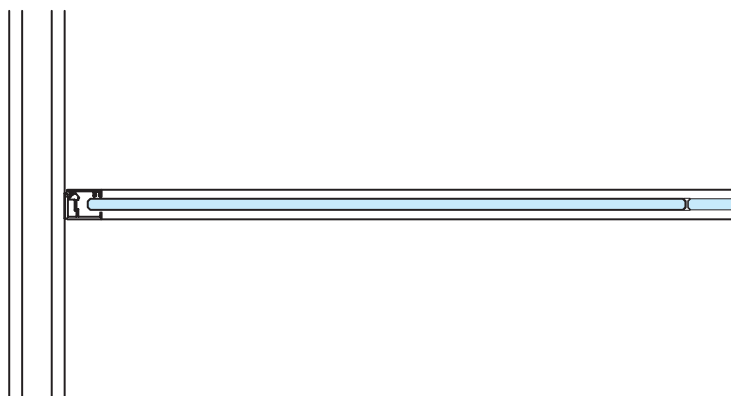

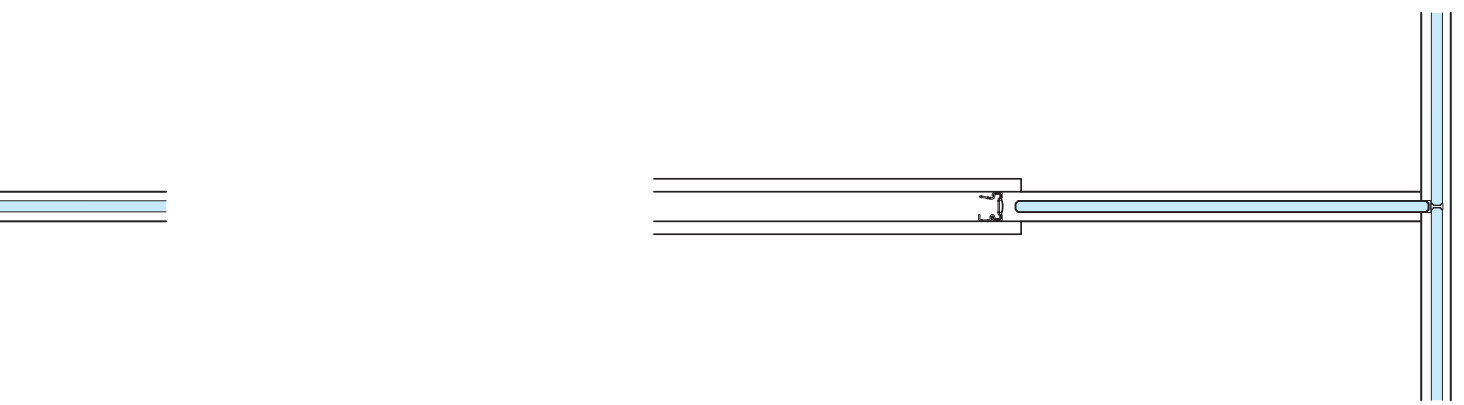
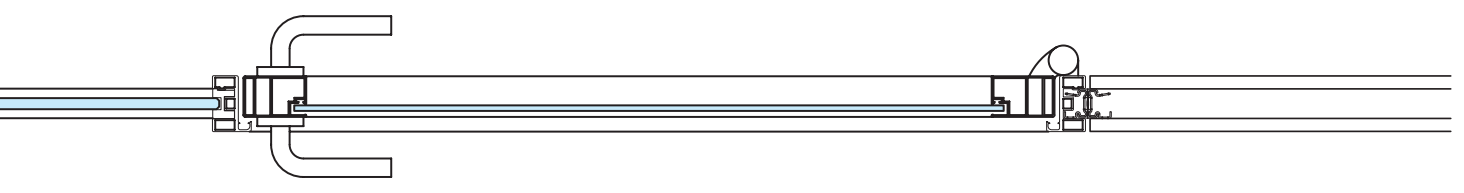
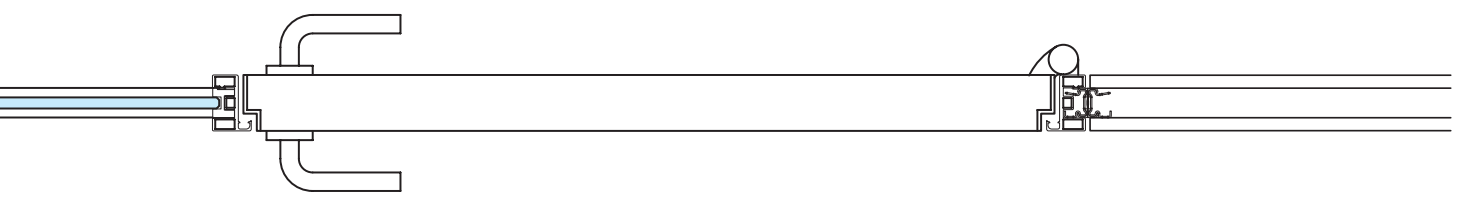
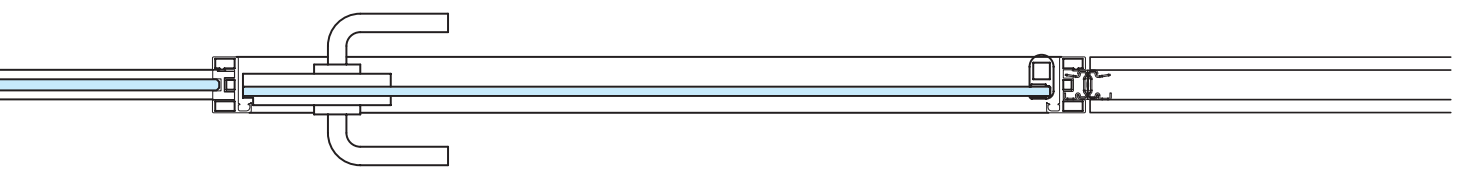
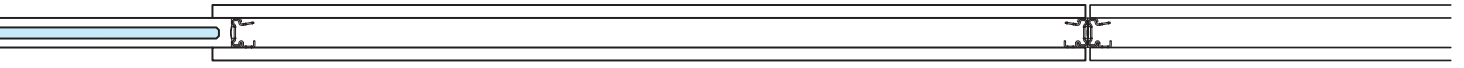











16









105

Parete divisoria vetrata con moduli ciechi spessi mm 105 e porte vetrate, con o senza intelaiatura in alluminio, e porte cieche alte cm 215 oppure fino al soffitto.

Glazed wall partition panels with solid, 105 mm thick modules and glass doors, with or without aluminium frame elements and solid, either 215 cm high or ceiling-high door options.

Cloison vitrée équipée de modules aveugles de 105 mm d'épaisseur et portes vitrées, avec ou sans cadre en aluminium, et portes aveugles de 215 mm de haut ou allant jusqu'au plafond.

Pared divisoria de vidrio con módulos ciegos de 105 mm de espesor y puertas de vidrio con o sin armazón de aluminio, y puertas ciegas de 215 cm de altura o altas hasta el techo.

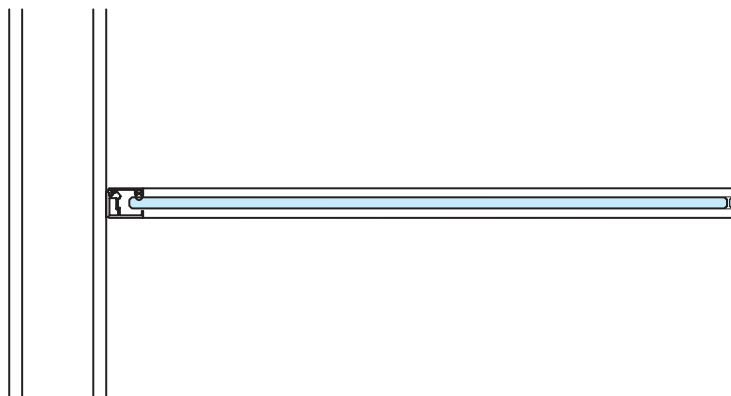
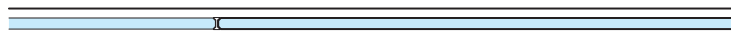
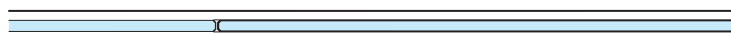

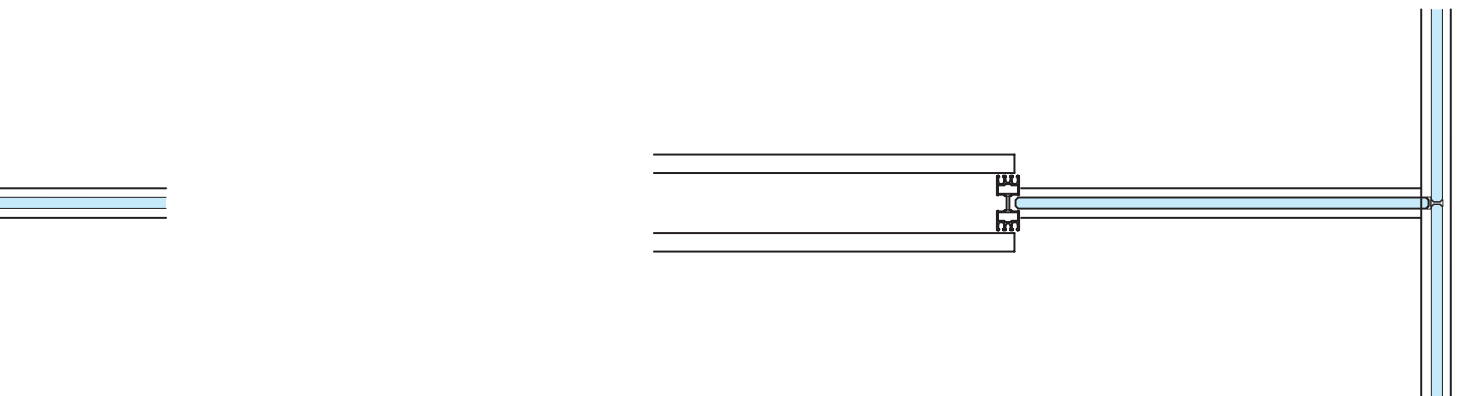
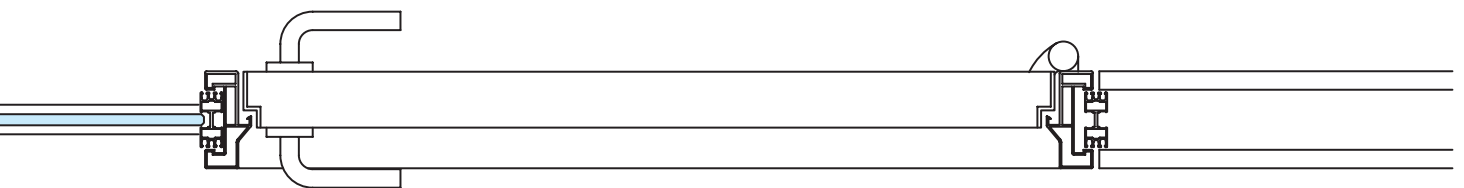
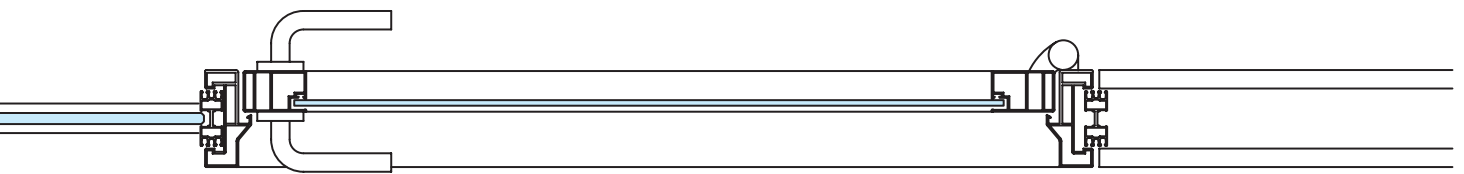
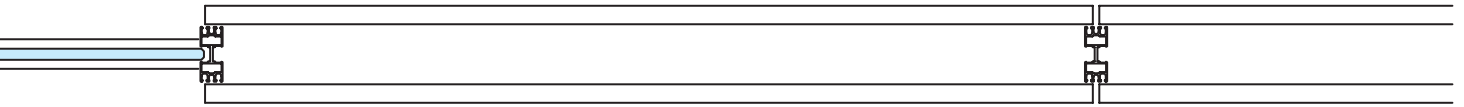















30



60

30

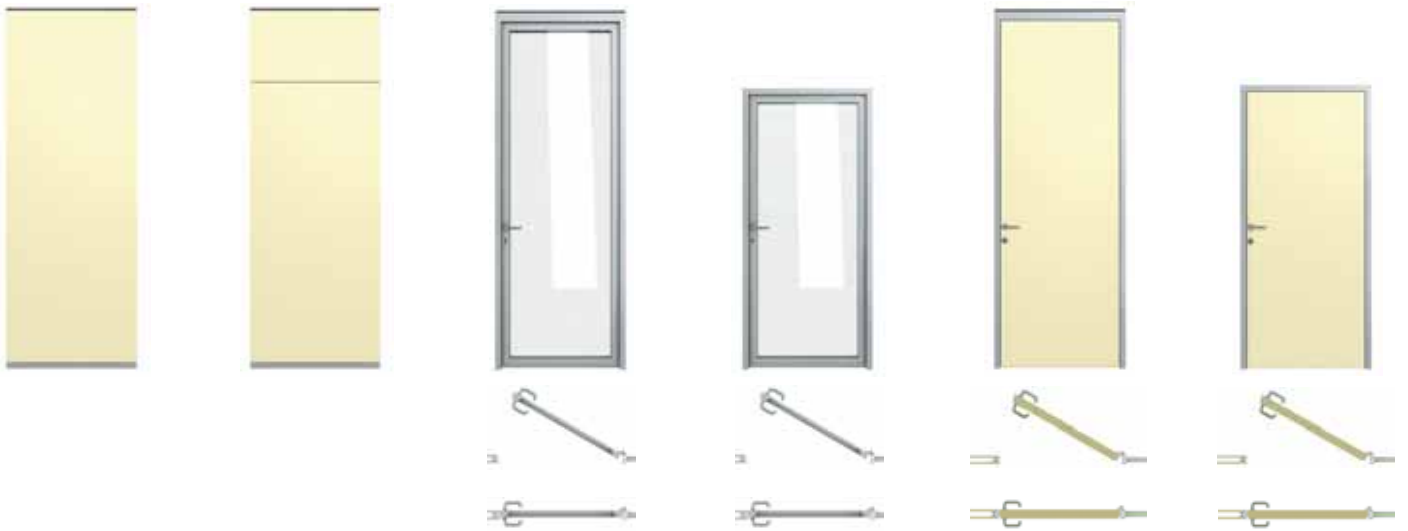

105



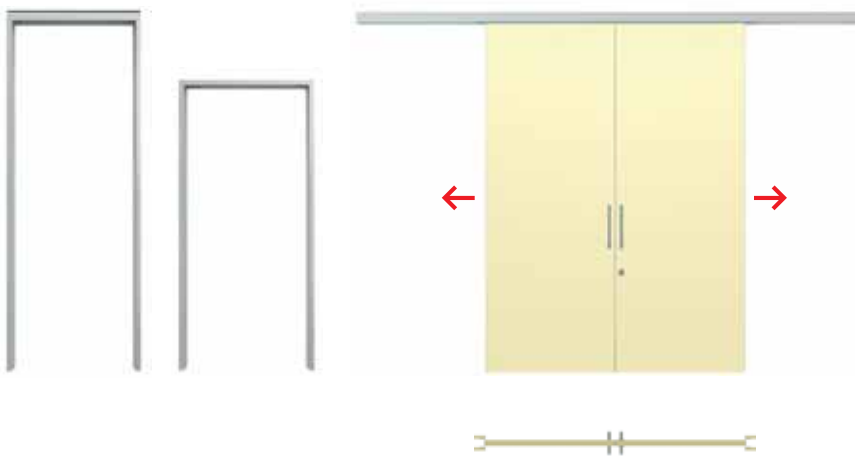
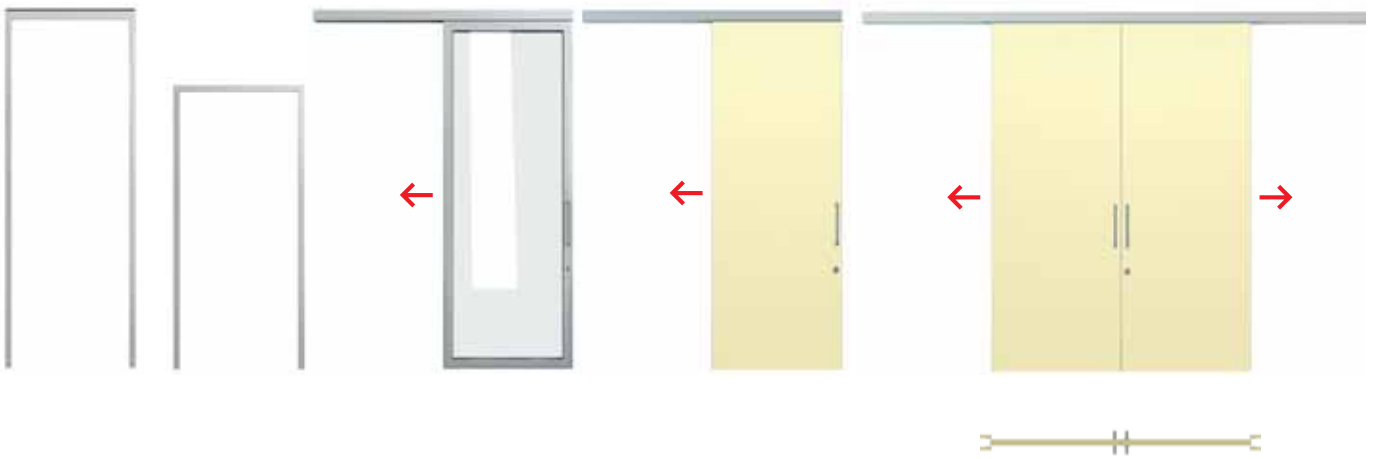
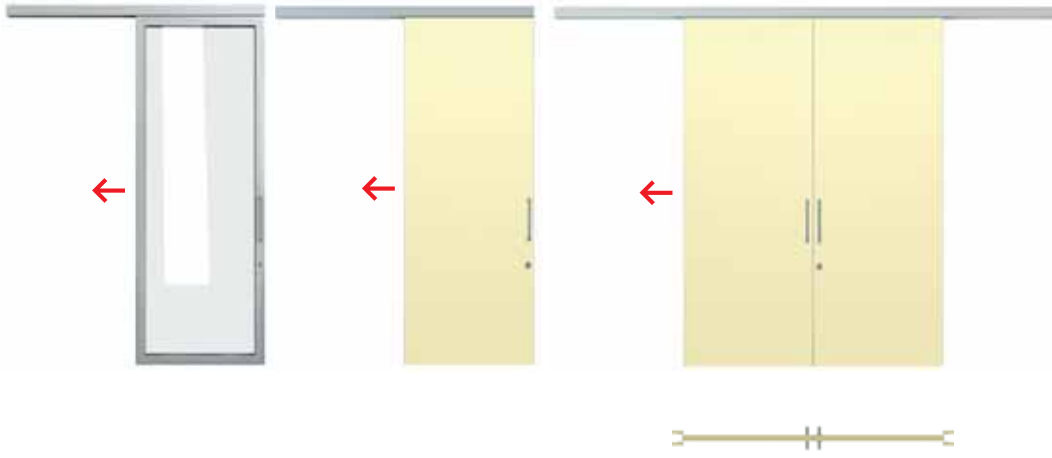

CISQ is a member of
I-Net
www.inet-certification.com

IQNet, the association of IQNet member organizations, certifies the competence of the certification bodies in the field of management systems certification. It is not responsible for the activities of the certification bodies and does not assume any liability for the activities of the bodies.

ICILA

CERTIFICATO N. **224**
CERTIFICATE N. **224**

SI CERTIFICA CHE IL SISTEMA DI GESTIONE PER LA QUALITÀ DI
WE HEREBY CERTIFY THAT THE QUALITY MANAGEMENT SYSTEM OPERATED BY

CITTERIO S.p.A.

Via Don G. Brambilla 16/18 - 23844 Sironè (LC)

UNITÀ OPERATIVE
OPERATIVE UNITS

Via Don G. Brambilla 16/18 - 23844 Sironè (LC)

È CONFORME ALLA NORMA
IS IN COMPLIANCE WITH THE STANDARD

UNI EN ISO 9001:2000

PER LE SEGUENTI ATTIVITÀ
FOR THE FOLLOWING ACTIVITIES

EA: 236

Progettazione, produzione ed installazione di arredamenti per ufficio e sistemi di pareti attrezzate e divisorie

Design, manufacturing and laying of office furniture and system of equipped walls and partitions

PIRELLA GÖTTSCHE LOWE per l'operabilità del marchio della Norma ISO 9001:2000
Pirella Göttsche Lowe for the operability of the ISO 9001:2000 requirement

Il logo di questo marchio certifica solo i prodotti di Progettazione per la certificazione del Sistema di Qualità
The use and validity of this certificate only apply to the products of the units for the certification of Quality Management System

PRIMA EMISSIONE FIRST ISSUE	EMISSIONE CORRENTE CURRENT ISSUE	DATA DI SCADENZA EXPIRING DATE
31/03/1999	15/07/2003	14/07/2006

Mauro Albertoni
ICILA S.r.l. - Via Eufemia 9 - 20135 Lissone (MI)
www.icila.org info@icila.org

ICILA S.r.l. è un'azienda italiana di
operazioni di certificazione del
sistema di gestione per la qualità
ICILA S.r.l. is an Italian company
of management systems
certification activities

CISQ

PIRELLA GÖTTSCHE LOWE

I-Net
THE INTERNATIONAL CERTIFICATION NETWORK[®]

CERTIFICATE

IQNet and its partner
CISQ/ICILA
hereby certify that the organization
CITTERIO S.p.A.
Via Don G. Brambilla 16/18 - 23844 Sironè (LC)

for the following field of activities
**Design, manufacturing and laying of office furniture
and system of equipped walls and partitions**
has implemented and maintains a
Quality Management System
which fulfills the requirements of the following standard
ISO 9001:2000

Issued on: 2003-07-15
Validity date: 2006-07-14
Registration Number: IT-7322

I-Net *Fabio Koversi*
President of IQNet

CISQ *Gianrenzo Prati*
President of CISQ

IQNet partners*:
AENOR Spain AFAQ France AIB-Vinçotte International Belgium AUCLIK (Slovakia) CISQ Italy CQC China
CUM China CQS Czech Republic DQS Germany DS Denmark ELCTI Greece ECAN Brazil FUNKUNOMBA Venezuela
HKQA A Hong Kong ICONTEC Colombia IRAM Argentina JQA Japan KEMA Netherlands RFO Korea MSZT Hungary
Nemko Certification Norway NSAI Ireland OQS Austria PCB Ireland PSC Certification Singapore QMI Canada
SAI Global Australia SES Finland SII Israel SIQ Slovenia SQS Switzerland SRAC Romania TISI St Petersburg Russia
IQNet is represented in the USA by the following partners: AFAQ, AIB-Vinçotte, International, CISQ, DQS, KEMA, NSAI, QMI and SAI Global
*The list of IQNet partners is valid at the time of issue of this certificate. Updated information is available under www.iqnet-certification.com

Citterio S.p.A

23844 Sirone (Lecco) Italia
Via Don G. Brambilla 16/18
T. +39-031-853545
F. +39-031-853529
vendite@citteriospa.com
www.citteriospa.com



ICILA

ISO 9001:2000