

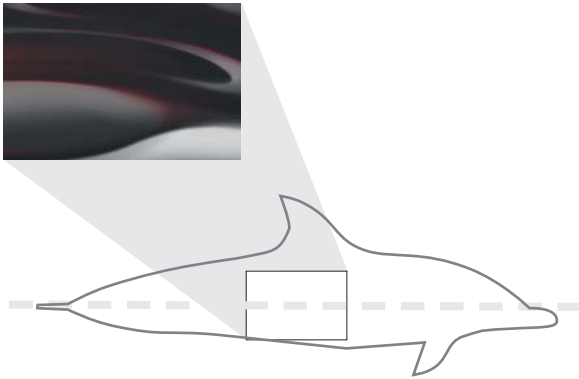

DOLPHIN
VELOCITY
—
HAND DRYERS

THE SKINS STORY

VELOCITY



PACIFIC WHITE-SIDED DOLPHIN
The pacific white-sided dolphin inhabits the cool to temperate waters of the North Pacific Ocean. It is extremely active and mingles with many of the north Pacific dolphin species. It often approaches boats to bow-ride, moving fast and saving them energy. Adults usually live for 40 years or more.



As the name suggests, Dolphin Velocity hand dryers leave conventional models trailing far behind - efficiently drying up to 80% faster, while saving energy and significantly improving hygiene.

The secret of their extreme rapidity and energy-efficiency is our advanced "Sweetspot" design, which also delivers outstanding performance in terms of space-saving and reduced noise levels.

Intelligent versatility? That's something else we've designed into the range, with a wide variety of surface-mounted, recessed or behind-mirror options - enabling you to create exactly the washroom you have in mind.

Aesthetically, too, the choice is yours, whether you prefer the robust stainless steel covers of your dryers in a satin, polished or powder-coated finish.

A firm promise of low maintenance costs, with the reassurance of Dolphin's no-quibble guarantee, completes the picture of a range of hand dryers with a clear competitive advantage.

CASE STUDY	2
BEHIND-MIRROR COLLECTION	4
<hr/>	
PRODUCTS	8



CASE STUDY

5 BROADGATE LONDON, UK

With 12 stories and over 700,000 square foot of floor space, 5 Broadgate is one of London's biggest single lettings. It was also an opportunity to create washrooms to match the building's forward thinking spirit...

Four trading floors were created at 6,500m² each, which has given rise to the term 'groundscaper'.

We designed the ideal modern washroom: mounted taps to minimise counter splash, bespoke combination units with special makeup bins to prevent toilet blockages and even matching sanitiser and toilet roll holders.

We worked with UBS facilities and Make Architects as the design consultants to create the perfect washroom. Not a single aspect was overlooked – we even changed the design of our soap dispensers and taps to suit the client's needs.

Our numerous site visits paid off and the client was delighted, particularly because our designs reduced carbon emissions by 65%. The low-energy Velocity behind mirror dryer was central to ensuring this is one of the world's greenest buildings.



FEATURED PRODUCTS



BC2003BM



BC360



BC267



DB100



BC633



BC900



BC9288BM

FOR FULL TECHNICAL DETAILS SEE DOLPHINSOLUTIONS.CO.UK

THE BEHIND-MIRROR COLLECTION



COLLECTION CURATED BY
DUNCAN FORD

The behind-mirror concept is a functional, easy to maintain and affordable solution for commercial washrooms. Previous challenges of queuing for hand dryers, water dripped across the floor; allocating space in the washroom for hand drying and complex-cleaning regimes prompted the simple behind-mirror concept to be developed. It enables users to wash and dry their hands at the basins, which takes away the need to move around the washroom to dry hands.

As a result, traffic flow decreases, walls become less cluttered, washrooms are spacious and there is less water on the floor. Constructed onsite by the joinery contractor, the individual mirror units allow soap, paper towel dispensers and hand dryers to be fitted inside - offering the complete experience in one unit. Many projects in the UK and abroad, have opted for the Dolphin Velocity hand dryer for their behind mirror applications. The BC2003BM is fast, has a low energy usage and is space efficient.

It's a well-proven solution for a sleek and functional washroom, which can be adapted to suit any type of project.

FEATURED PRODUCTS



BC634



BC2003BM



DB1400



BC915



DB1504



BC9288BM



BC2001 Satin stainless steel

BC2001 DOLPHIN HIGH SPEED HAND DRYER

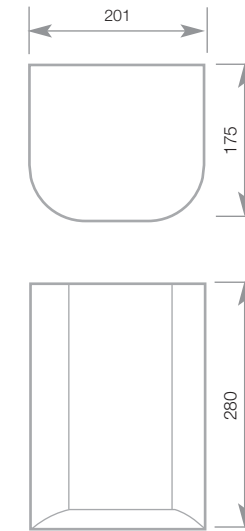

280 MM HEIGHT
201 MM WIDTH
175 MM PROJECTION



BC2001B Polished stainless steel



BC2001W White metal

- > Quality satin stainless steel body with all metal back plate for excellent vandal resistance
- > Very low energy usage saving 70% or more of user's energy costs
- > Our highest power velocity dryer in the range
- > Heater on/off switch and adjustable airflow gives the potential for even greater energy savings
- > Dries hands in only 10-12 seconds with heater and full speed – reducing CO₂ emissions drastically
- > Five year limited warranty

BC2002 DOLPHIN ECO HAND DRYER

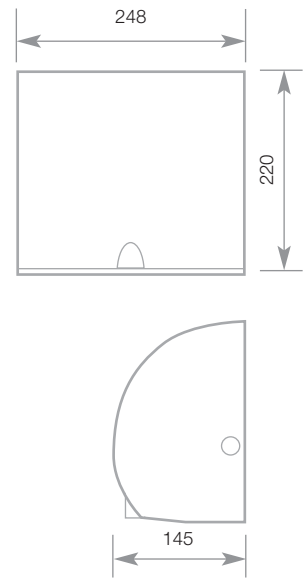

220 MM HEIGHT
248 MM WIDTH
145 MM PROJECTION



BC2002W White metal

- > Quality stainless steel body with all metal back plate for excellent vandal resistance >Very low operating power saving 80% or more of user's energy costs
- > Along with the BC2005 it is our most efficient hand dryer in the range
- > Heater on/off switch and adjustable airflow gives the potential for even greater energy savings
- > Dries hands in only 12-15 seconds with heater and full speed – reducing CO2 emissions drastically
- > Three year limited warranty

BC2002 Satin Stainless steel



BC2005 DOLPHIN SLIMLINE ECO HAND DRYER

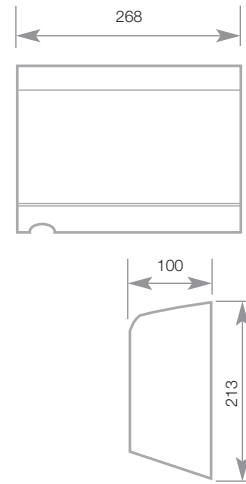

213 MM HEIGHT
268 MM WIDTH
100 MM PROJECTION

- > Quality stainless steel body with all metal back plate for excellent vandal resistance
- > Only 100mm depth of body reducing impact in the washroom and complying with the ADA Disability Act
- > Very low operating power saving 80% or more of user's energy costs against conventional hand dryers
- > Heater on/off switch and adjustable airflow giving the potential for even greater energy savings
- > Dries hands in under 15 seconds with heater on at full speed – reducing CO2 emissions drastically
- > Three year limited warranty
- > IP24 rated – very high IP rating for a hand dryer rendering it suitable for use in mental health institutes.

BC2201SS DOLPHIN HOT AIR HAND DRYER

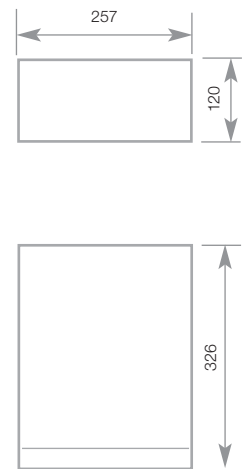

326 MM HEIGHT
257 MM WIDTH
120 MM PROJECTION

- > Stylish design made of tough 1.5mm thick stainless steel for strength and durability
- > Only 73db ± 3 metre making it our quietest dryer in the range
- > 5 year manufacturer's warranty
- > IPX1 rated

BC2012 DOLPHIN HAND DRYER

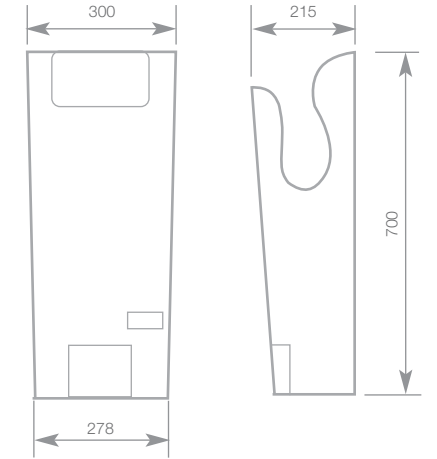

700 MM HEIGHT
300 MM WIDTH
215 MM PROJECTION

- > Quality ABS plastic body
- > Dries hands in 10-12 seconds
- > Low-Carbon DC Motor; 750W - 2050W
- > Air speed 95m/s
- > Antibacterial 99.9% HEPA dust filter ensuring clean air
- > IPX4 Rated
- > Sound level: 75dB(A) at 1m
- > With integral drip tray to ensure no water drips onto the floor

BC2400SA DOLPHIN HOT AIR HAND DRYER

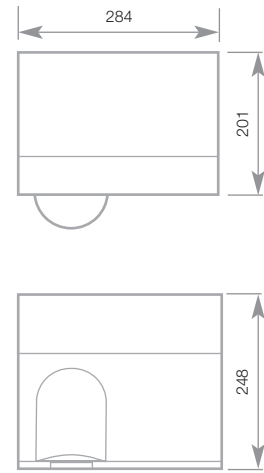

248 MM HEIGHT
284 MM WIDTH
201 MM PROJECTION

- > Quality hot air dryer with a 1.2mm stainless steel cover
- > Brush motor: 2400W, 5,500rpm
- > Dryer delivers 345 m³/h (202 CFM)
- > Sound level: 70 ± 3 db
- > Approximately 20-25 seconds drying time
- > IPX1 rated
- > Five year manufacturer's warranty

BC2400CA DOLPHIN HOT AIR HAND DRYER

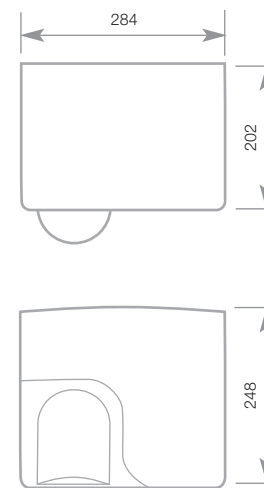

248 MM HEIGHT
284 MM WIDTH
202 MM PROJECTION

- > Quality hot air dryer with a 2.0mm satin chrome cover
- > Brush motor: 2400W, 5,500rpm
- > Dryer delivers 345 m³/h (202 CFM)
- > Sound level: 70 ± 3 db
- > Approximately 20-25 seconds drying time
- > IPX1 rated
- > Five year manufacturer's warranty
- > Also available as bright chrome finish – **BC2400MA**

BC2200RA DOLPHIN CHROME HOT AIR HAND DRYER

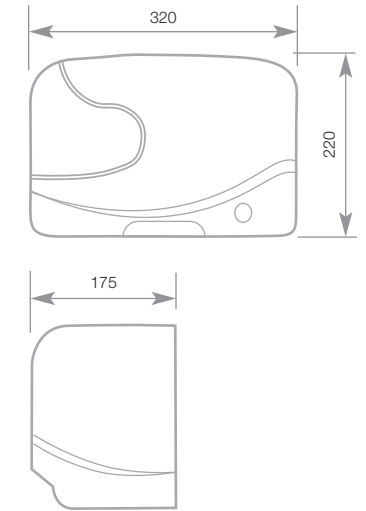

220 MM HEIGHT
320 MM WIDTH
175 MM PROJECTION

- > Polished chrome plated die-cast aluminium cover for strength and durability even in high corrosion environments such as swimming pools
- > Certification of Compliance to foremost international Safety standards (CE& UL) & performance standards (UL)
- > Power rating: Heating element 2100 watt
- > 100 watt induction motor
- > ROHS Compliant
- > Sound level: 66.1 dB at 1M
- > Approximately 30-35 seconds drying time
- > IPX1 Rated



BC2200W White

BC230C DOLPHIN CHROME PLATED HOT AIR HAND DRYER
BC230W DOLPHIN WHITE METAL HOT AIR HAND DRYER



245 MM HEIGHT
 265 MM WIDTH
 155 MM PROJECTION

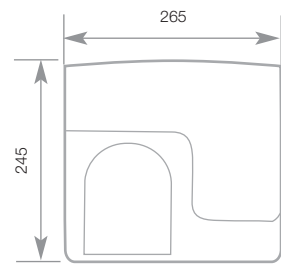

- > Durable metal construction – vandal resistant
- > Low cost dryer
- > Rated power: 2500w
- > IPX1 rated
- > 360° revolving nozzle
- > 2 year manufacturer's warranty
- > Approximately 20-25 second dry time

BC2006 DOLPHIN SEMI RECESSED HIGH SPEED HAND DRYER

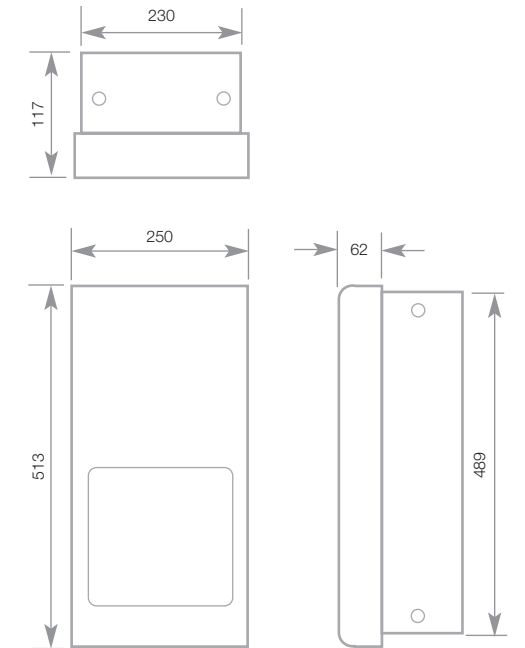

513 MM HEIGHT
 250 MM WIDTH
 62 MM PROJECTION

- > Semi-recessed stainless steel dryer
- > Low energy usage - reduces power consumption by up to 70%
- > 600w Hot Air Hand Dryer
- > 700w motor
- > 900w heating element
- > Dries hands in 10-15 seconds
- > IPX1 rated
- > Very small projection
- > Five year warranty
- > Ska compliant product

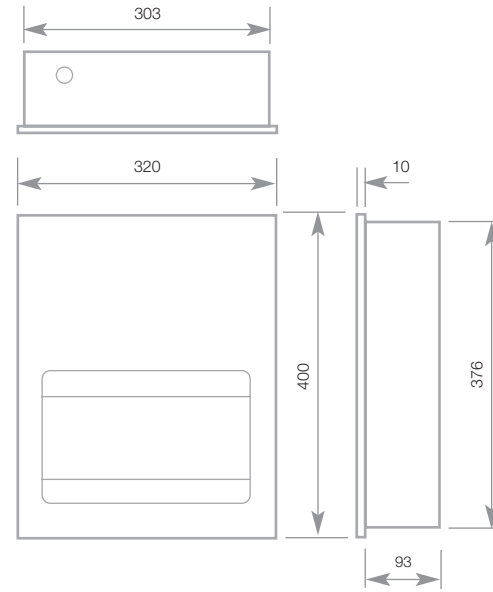

400 MM HEIGHT
320 MM WIDTH
10 MM PROJECTION

- > Combined power output 500-1000W
- > Ultra-slim recessed hand-dryer – only 94mm recess depth and projection of 10mm
- > Sound level of 75dB at 1 metre
- > IP 24 rated
- > Dryer delivers 91.3m³/hour
- > This dries hands within 15 seconds, reducing the CO₂ emissions
- > Three year limited warranty
- > Ska compliant product

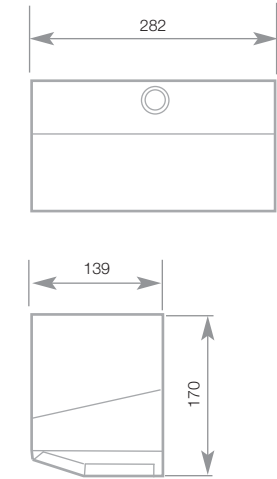

170 MM HEIGHT
282 MM WIDTH
139 MM DEPTH

- > High speed, behind mirror hand dryer
- > High speed low energy hand dryer
- > Dries hands in 13 seconds reducing the CO₂ emissions
- > Rated power: 1,000w, 6.5A
- > Operating power of only 1,000w (500w heating element) – saving 80% of user's energy costs
- > Sound level of 75db at 1 metre
- > IP14 rated
- > Class I rated isolation
- > Three year limited warranty

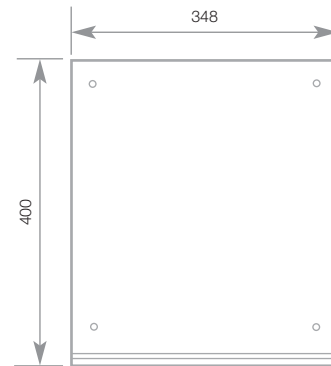

400 MM HEIGHT
348 MM WIDTH
15 MM PROJECTION

Satin stainless steel

PRODUCT CODES



BC2000W White metal



BC2000B Polished stainless steel



- > High quality stainless steel
- > Manufactured in the same factory as the bulk of our hand dryer range for finish match
- > Unique drip detail to throw water off the wall
- > Eliminates the staining caused by water-run common with high speed dryers

TECHNICAL SPECIFICATIONS

	CHEAPEST	QUIETEST	RECESSED	ENERGY EFFICIENT	SLIMMEST
	BC230C	BC2200 W	BC2007	BC2003 BM	BC2005
Sound	85 +/- 3 dB	66.1 dB	75 dB	75 dB	74.3 dB
How quick to dry hands	20-25 seconds	30-35 seconds	15 seconds	13 seconds	15 seconds
Warranty	2 years	5 years	3 years	3 years	3 years
Air volume	270m3/hour	225 m3/hour	91.3 m3/hour	101.7m3/hour	102 m3/hour
Brush motor			16,000-29,000 rpm	29,000 rpm	
Air speed	30 m/s	14.5 m/s	90 m/s	90 m/s	70.0 m/s
IP Rating	IPX1	IPX1	IP24	IPX14	IP24
Efficiency	D	C	A*	A*	A*

SAVING TIME, SAVING ENERGY, SAVING MONEY, SAVING CROSS-CONTAMINATION

- > Dolphin Velocity Hand Dryers save up to 70% of the electricity used by conventional hand driers by optimising airflow and heat ratios.
- > Low maintenance & energy costs ensure you receive payback with one year in a busy washroom.
- > We have a design to meet your requirements...backed up with long guarantees and onsite support

<p>HIGH SPEED HAND DRYER 1.6KW drying your hands in 10 seconds</p>  <p>Only £93.32 per annum</p>	<p>LOW SPEED HAND DRYER 2.2KW drying your hands in 30 seconds</p>  <p>£384.98 per annum</p>	<p>PAPER TOWELS (allow 2 sheets per visit)</p>  <p>£1750.00 per annum</p>
---	--	--

Our Dolphin Velocity texture was inspired by the Pacific White-Sided Dolphin – appropriately enough, one of the fastest swimming species of dolphin.

Dolphin Solutions Ltd
Southpoint, Compass Park,
Junction Road
Bodiam, TN32 5BS,
United Kingdom
T +44 (0)1424 202 224
info@dolphinsolutions.co.uk
dolphinsolutions.co.uk

© Dolphin Solutions Ltd