



EXTERIOR
CATALOG



Natural State of Wood



INDEX

FACTORY & PRODUCTION	6
NOVA CLADDING	21
Nova-Ash Cladding	23
Nova-Iroko Cladding	25
Nova-Pine Cladding	27
Nova-Ayous Cladding	29
Nova-Tulipwood Cladding	31
Cladding Profile Types	33
SUNSHADE & PERGOLA	37
Sunshade	39
Sunshade Dimensions & Profiles	41
Nova-Pergola	43
NOVA DECKING	47
Nova-Ash Decking	49
Nova-Iroko Decking	51
Nova-Pine Decking	53
Nova-Tulipwood Decking	55
Decking Profile Types	57
Designed Decking	59
Nova-Tile Decking	61
CUSTOM SOLUTIONS	65
Carcass	66
End Matching	67
Screw	67
Nova-Pedestal	68
Lamination	69
Finger - Joint	69
Nova-Clips	70
SURFACE APPLICATIONS	77
Nova-Croco	79
Nova-Sahara	80
Nova-Vintage	80
Nova-Brushed	81
Coating / Oiling	81
Window Scantling	82
Door Scantling	83
Urban Furnitures	85
Nova-Timber	87
NOVAWOOD IN 6 CONTINENTS	128

As Novawood, we set out to transform the weaving texture of the “tree” into the texture of “life”. Our aim was to transform the most beautiful gift of nature into living spaces that breathe. At the point we have reached today, we feel that we are bringing the nature one step closer to humans through each new design developed.

While trying to preserve the forest richness of our world with the sustainable solutions, we embrace the “long life span” as the most important brand value of our products.

We are inspired by the nature itself in terms of harmony and aesthetics, and we preserve our products with the most advanced thermal modification method “Thermowood” for ultimate “durability” and “endurance”.

We have a justified pride in our position as being the first company introducing the thermal modification technology “thermowood” in Turkey. We develop and direct every stage of the production process with innovative approaches which add value to the life. We strive to reinforce the wood products and wooden materials, which we regard as living materials, without compromising the aesthetics and naturalness of the product.

Our aim is to offer the precious gifts of the nature by preserving them in their most natural state.

“Nature cannot be considered apart from us, it is part of us.”

NOVAWOOD

*Feel the warmth of the nature
in your living spaces*







FACTORY & PRODUCTION

Novawood is a world leading manufacturer of the thermowood sector with its high quality products, technological infrastructure and wide product range. The company produces 18,000 m³ of Novathermowood timber and 600,000 m² of finished products annually at its facilities located in Bolu Gerede, Turkey. Products manufactured at Novawood facilities are in compliance with the international quality standards. The quality is accredited as Novawood has participated in the research and quality control studies of the internationally accredited organizations in the sector.

Thermowood products mainly produced by Novawood include exterior claddings, deckings, sunshades, pergolas, door and window scantlings, materials for urban furnitures, blinds and shutters, solid and engineered floorings and interior wall coverings.

Novawood constantly renews and develops its product range in accordance with the needs and demands of the industry, without sacrificing quality. Working with a focus on the customer satisfaction and quality, Novawood also produces special products suitable for the large architectural projects and customer specific solutions.

INTERNATIONAL
ThermoWood
ASSOCIATION



* Look for our FSC® certified products



Novawood Headquarter ■



Novawood Showroom ■

NATURAL STATE OF WOOD

THERMOWOOD

Why does thermally modified wood get high marks for its increased stability and durability ratings? Heat treatment increases the stability and durability of wood. Wood is composed of 50% cellulose, 23% hemicellulose, 20% lignin, and 7% other organic compounds, called extractives. Heat treatment eliminates resin, all other extractives and bonding water called OH (Hydroxyl) groups from the wood. This process reduces water absorption of wood, consequently increasing decay resistance while decreasing swelling and shrinking. Another factor that contributes to the high durability of wood is the crystallization of cellulose. The change in hemicellulose increases the durability. Hemicellulose is separated into furfural and carboxylic acid. Caramelization of lignin, caused by heat, results in a darker colour appearance of the wood.

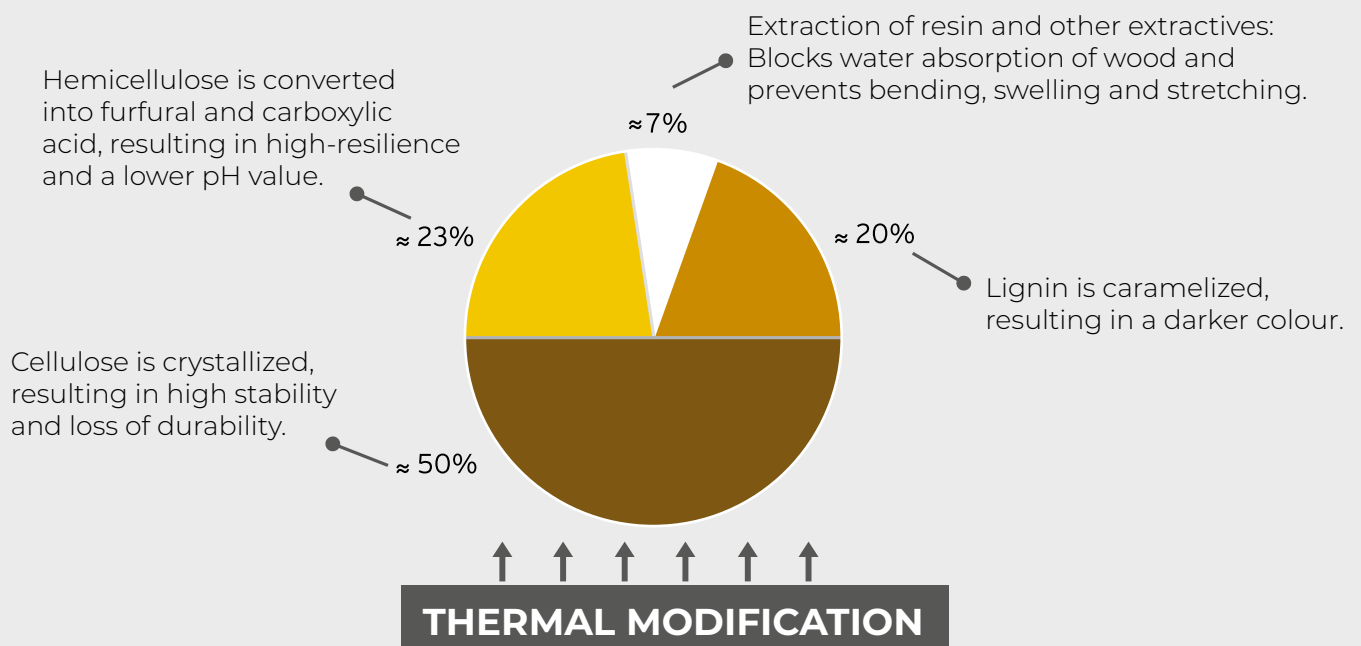

THERMOWOOD PROCESS

1 H_2O and OH bonding water are roaming inside the wood.

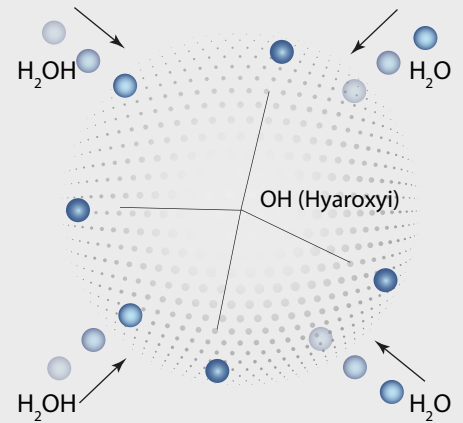

2 By regular drying (up to 90°) free waters are released out of the wood cell.

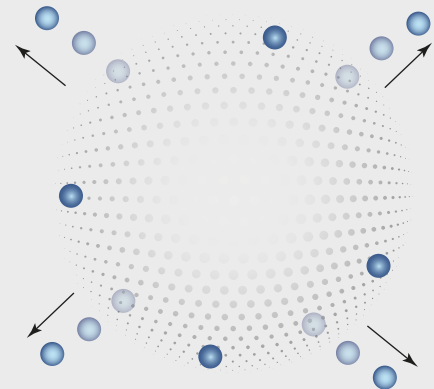

3 Through the Thermowood process ($180 - 212^\circ C$), the relative humidity (OH) is released from the cell and the working tendency of the wood is minimized.

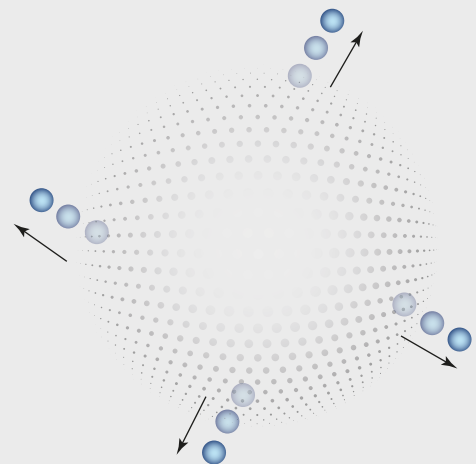















The most natural and technological method of wood preservation is Thermowood process. At the end of this process in which no chemicals are used, we obtain environmentally friendly, sustainable, weatherproof products with the highest quality.



Environmentally Friendly



Biological Resistance

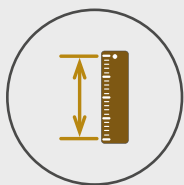

Dimensional Stability

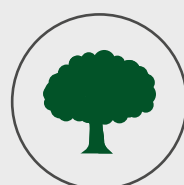

Sustainability



Weatherproof



Easy Maintenance



High Quality



Non Toxic







Nova-Claddings are long-lasting and stable, allowing for horizontal and vertical applications with its size and profile options.

Thus, while supporting the design and aesthetic appearance of your buildings, it also provides a high resistance to all weather conditions.



NOVA CLADDING

|| novawood®
INTERIORS & EXTERIORS

— NOVA-ASH CLADDING

novathermowood®

Rönesans Biz Plaza - Mecidiyeköy ■



NOVA-ASH CLADDING

Ash is a hardwood with a high number of grains, and features an elegant look with its wavy texture. These features make Nova-Ash Cladding a multipurpose, aesthetic and durable material. If you seek an elegant look to highlight your buildings, durable and reliable Nova-Ash cladding is the right choice.



novathermowood**** Ash cladding provides a flawless appearance and durability due to its wavy texture, performance and structural feature.

DIMENSIONS

Profile	Thickness (mm)	Width (mm)	Length (mm)
Standard	8	90 / 130	800 - 3600
Standard	10	90 / 130	800 - 3600
Standard	20	92 / 100 / 117 / 130 / 150 / 160 / 180	800 - 3600
Standard / Special	25	130 / 150	800 - 3600

novawood[®]
INTERIORS & EXTERIORS

■ NOVA-IROKO CLADDING

novathermowood[®]

Atılgan Royal Mavişehir ■



NOVA-IROKO CLADDING

The exotic Iroko is an ideal exterior cladding material with its durability, light amber colour and elegant look that captures perfection with its modern aspect.

In the process starting with the extraction from the nature, we make the exotic iroko tree, which stands out with its long biological life and simplicity, much more stable due to the thermowood process. Consequently, it becomes an ideal, problem-free material with a minimized working tendency. Nova-Iroko cladding drives your projects elite and modern by adding an aesthetic appearance with its elegance.



novathermowood**** Nova-Iroko cladding will help you to capture a modern aspect at your spaces with its honey colour, uniform texture and plain appearance.

DIMENSIONS

Profile	Thickness (mm)	Width (mm)	Length (mm)
Clean-More	8	92	800 - 3000
Clean-More	10	92	800 - 3000
Standard / Sigma / Theta	19	92 / 120	800 - 3000

— **NOVA-PINE CLADDING**



NOVA-PINE CLADDING

Being one of the most abundant tree species in the nature, the pine is transformed into Nova-Pine cladding through the thermowood process to present you the most natural one in the best way. It offers an ideal solution for those who seek a natural look on their facades and can't resist the charm of pine.



novathermowood It's knotty structure is preferred by those who love the traditional. With its unique harmony with the nature, perfect adaptation to all weather conditions, cost-benefit balance, Nova-Pine claddings are carefully produced for your buildings.

DIMENSIONS

Profile	Thickness (mm)	Width (mm)	Length (mm)
Standard	16	92	1000 - 5100
Standard	19	92 / 118 / 120 / 138 / 140	1000 - 5100
Standard	20	118 / 120	1000 - 5100
Standard / Special	26	92 / 118 / 120 / 138 / 140	1000 - 5100

NOVA-AYOUS CLADDING



NOVA-AYOUS CLADDING

Nova-Ayous has a highly admired and particularly preferred yellow-brown color, and it becomes an indispensable tropical wood option on the exteriors with its knot-free structure and unique texture. Simultaneously, it provides a great convenience in the applications by not imposing any extra load on the facades through its light structure. All the durability and dimensional stability features of our other thermowood products are also valid for Nova-Ayous claddings.



novathermowood** Nova-Ayous claddings are presented as an economical alternative with their smooth structure and easy processability, simple and elegant structure.**

DIMENSIONS

Profile	Thickness (mm)	Width (mm)	Length (mm)
Clean - More	8	92	1000 - 4000
Standard	16	92	1000 - 4000
Standard	18	92	1000 - 4000
Standard	20	92 / 140	1000 - 4000
Standard / Special	25	90 / 120 / 130 / 140 / 150	1000 - 4000

— **NOVA-TULIPWOOD CLADDING**



NOVA-TULIPWOOD CLADDING

Tulipwood is classified as a hardwood specie which is the basic tree type of sustainable forests. Its plain grain structure, dark caramel color and lightweight will add a different perspective to outdoor usages. We call it 'authentic' because of its plain surface and distinctive structure.



novathermowood** Due to its ability to be obtained in long length proportions, it is preferred in construction sites by providing ease of planning.**

DIMENSIONS

Profile	Thickness (mm)	Width (mm)	Length (mm)
Standard / Special	20	130 / 150	1200 - 4200

■ NOVA-ASH CLADDING

STANDARD
PROFILES

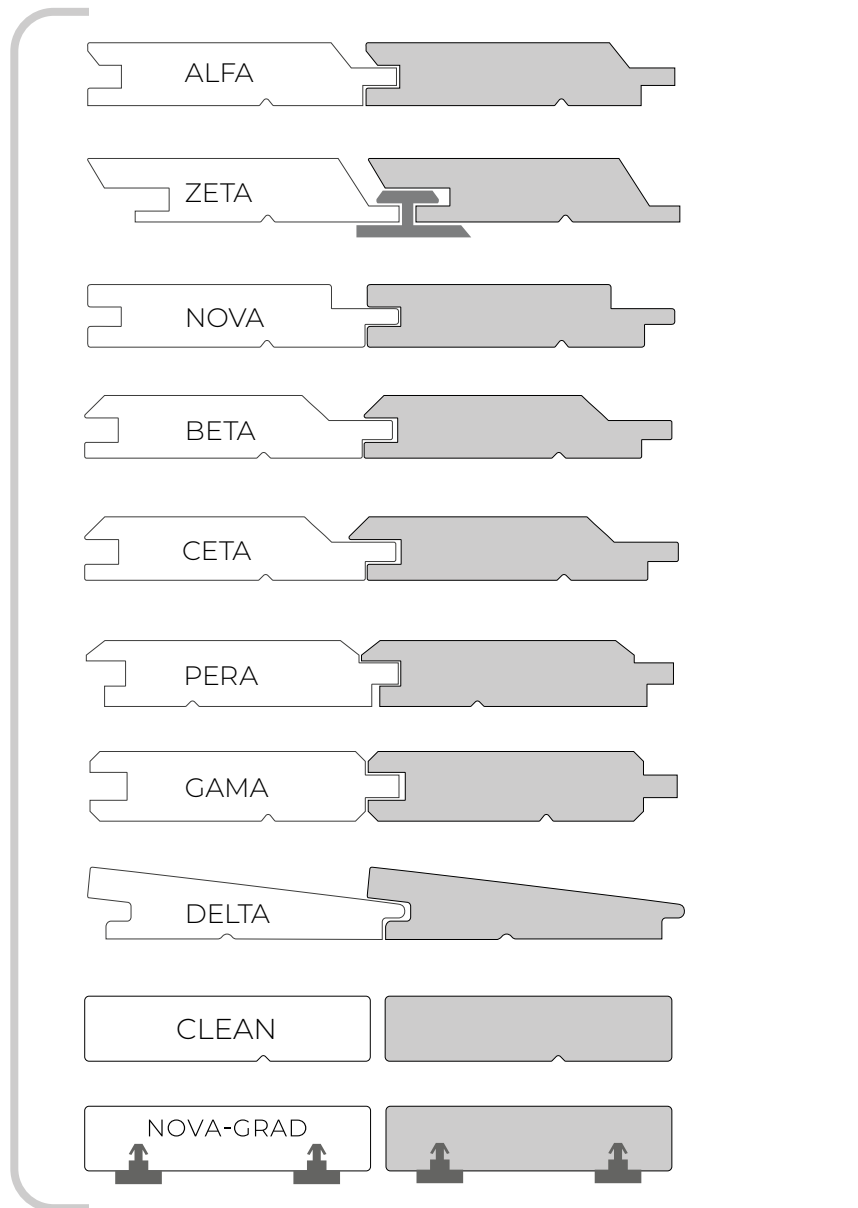

SPECIAL
PROFILES

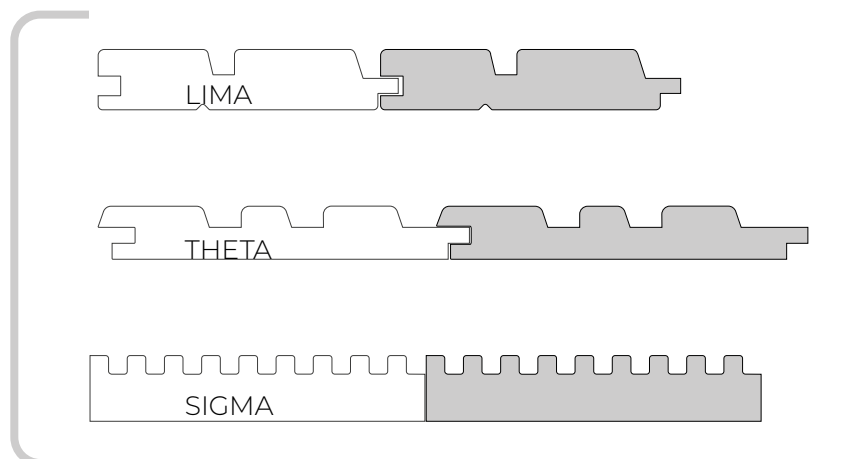







Nova-Sunshade products offer an ideal solution and a modern cladding alternative for buildings that are exposed to sunlight throughout the day.



& SUNSHADE
PERGOLA

NOVA-SUNSHADE



Vicem
Villas



novathermowood**** Nova-Sunshades do more than simply protecting from the effects of the sun; but also add a decorative value to your living spaces.



novathermowood**** While optimally benefiting from daylight, your living spaces will take on a striking beauty. Experience the comfort of wood with its useful and functional structure. We united shade and sun in wood.

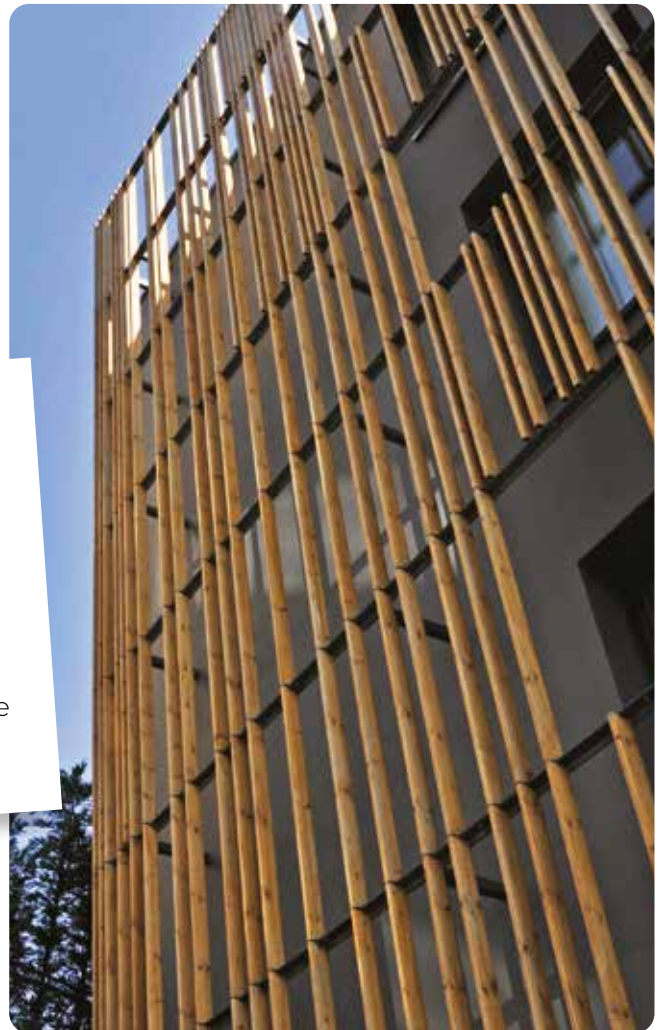

Ulus Savoy

 **novawood**[®]
INTERIORS & EXTERIORS

— **NOVA-SUNSHADE**

novathermowood

Sarp Construction ■

SUNSHADE DIMENSIONS & PROFILES

nova**thermowood**
Nova-Ash Sunshade

Profile	Thickness(mm)	Width(mm)	Lenght(mm)
Clean / More / Rombus	20	42 / 55 / 65 / 90 / 112 / 130	1200 - 3600
Clean / More / Rombus	25	42 / 55 / 65 / 130	1200 - 3600
Clean / More / Rombus	30	65 / 130	1200 - 3600
Clean / More / Rombus	40	40 / 65 / 90 / 115 / 130	1200 - 3600
Omega	40	40	1200 - 3600

nova**thermowood**
Nova-Iroko Sunshade

Profile	Thickness(mm)	Width(mm)	Lenght(mm)
Clean / More / Rombus	20	40 / 90	800 - 3000
Clean / More / Rombus	40	40	800 - 3000
Omega	40	40	800 - 3000

nova**thermowood**
Nova-Pine Sunshade

Profile	Thickness(mm)	Width(mm)	Lenght(mm)
Clean / More / Rombus	19	42 / 55 / 92 / 118	1000 - 5100
Clean / More / Rombus	26	42 / 55 / 65 / 92 / 118 / 138	1000 - 5100
Clean / More / Rombus	42	42 / 65 / 90 / 138	1000 - 5100
Omega	42	42	1000 - 5100

nova**thermowood**
Nova-Ayous Sunshade

Profile	Thickness(mm)	Width(mm)	Lenght(mm)
Clean / More / Rombus	20 / 42	42 / 65 / 90 / 140	1000 - 4000
Omega	42	42	1000 - 4000

nova**thermowood**
Nova-Tulipwood Sunshade

Profile	Thickness(mm)	Width(mm)	Lenght(mm)
Clean / More / Rombus	20 / 42	42 / 65 / 130	1000 - 4200
Omega	40	40	1000 - 4200

PROFILES

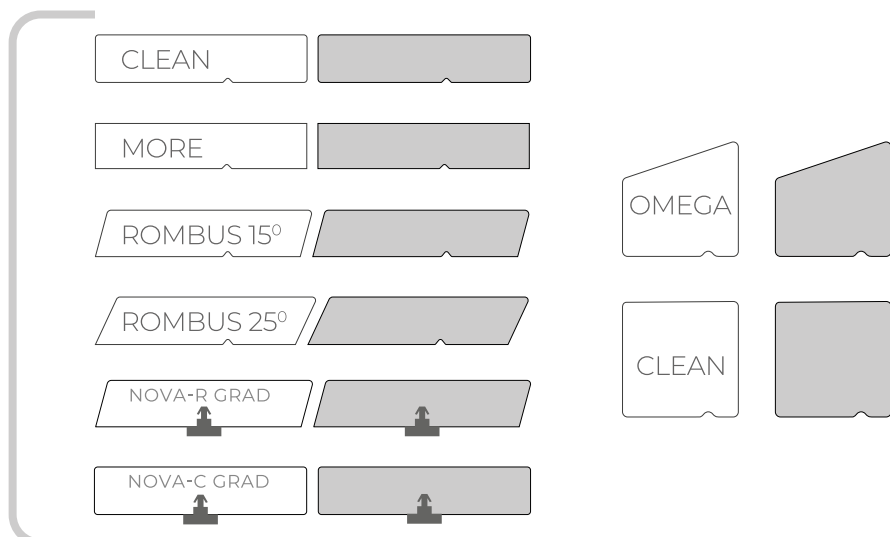

NOVA-PERGOLA

Nova-Pergola is one of the very special solutions that will add elegance and value to your spaces.

Nova-Pergola, which you can use for shading in areas where you rest, relax and enjoy, as well as for purely aesthetic reasons, will fascinate those who see it with its elegance.



As lamination process is applied to have large sizes, products in special sizes can be provided for your projects.

Folkart

Nova-Pergola is a natural and useful solution that will allow you to use unique designs for garden decorations.

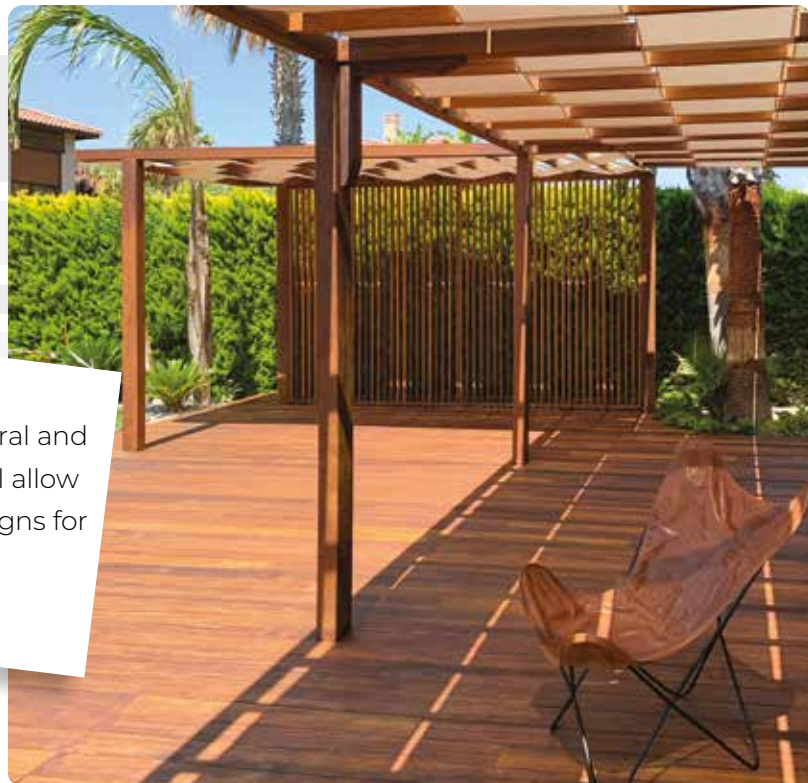

Private Villa







Choose the most suitable product for you from the Nova-Deck portfolio, enjoy life with a natural product that you will not give up stepping on for years.



NOVA DECKING

— **NOVA-ASH DECKING**



NOVA-ASH DECKING

Nova-Ash decking turns out to be an indispensable product for outdoor usage with its aesthetic appearance, long life span and durability. Through the thermowood process of Novawood, the biological durability of ash decking material increases and becomes resistant to the outdoor weather conditions.



novathermowood** Its attractive brown colour, beautiful grain structure, dimensional stability and technical features add value to the spaces and ensures optimum results.**

DIMENSIONS

Profile	Thickness (mm)	Width (mm)	Length (mm)
Standard	20 / 21	80 / 90 / 112 / 125 / 130 / 140 / 150	800 - 3600
Standard	25	90 / 115 / 125 / 130 / 140 / 150 / 160	800 - 3600
Standard	30	90 / 115 / 130 / 150	1000 - 3000
Standard	40	65 / 90 / 115 / 130 / 150	1000 - 3600



— **NOVA-IROKO DECKING**



NOVA-IROKO DECKING

For those who prefer to be stylish with an exotic touch, we offer a product that can crown their perspective.

Hard structured iroko tree gains many features as it has increased durability as a result of the thermowood process of Novawood.



novathermowood**** The exotic Nova-Iroko provides an ideal decking material with its durability, light amber colour and an elegant look that captures perfection with its modern aspect.

DIMENSIONS

Profile	Thickness (mm)	Width (mm)	Length (mm)
Standard	20 / 26 / 40	90 / 120	800 - 3000
Special	8 / 10	90	800 - 3000

■ NOVA-PINE DECKING



NOVA-PINE DECKING

We bring the traditional structure of pine tree to your spaces with an innovative solution. Pine tree, which has been the most abundant tree species in the nature, provides a unique beauty as well as the optimum benefit with the Novathermowood process.

Nova-Pine deckings are carefully produced for your buildings with its perfect harmony with the nature, perfect adaptation to all weather conditions, and its cost-benefit balance.



novathermowood It stands out as the most ideal and economical solution for those who cannot give up the appearance of naturalness of the knotty structure and the preference of the traditional.

DIMENSIONS

Profile	Thickness (mm)	Width (mm)	Length (mm)
Standard	26	92 / 118 / 138	1000 - 5100
Standard	42	92 / 138	1000 - 5100



— ■ NOVA-TULIPWOOD DECKING



NOVA-TULIPWOOD DECKING

Tulipwood is classified as a hardwood specie which is the basic tree type of sustainable forests. Its plain grain structure, dark caramel color and lightweight will add a different perspective to outdoor usages. We call it 'authentic' because of its plain surface and distinctive structure.



novathermowood** Tulipwood decking is acclaimed to add a different perspective to your projects with its long length proportions, unique texture and color.**

DIMENSIONS

Profile	Thickness (mm)	Width (mm)	Length (mm)
Standard	21 / 25 / 40	130 / 150	1200 - 4200



novawood[®]
INTERIORS & EXTERIORS

— **NOVA-IROKO DECKING**

novathermowood[®]

Rixos Dubrovnik ■

STANDARD
PROFILES

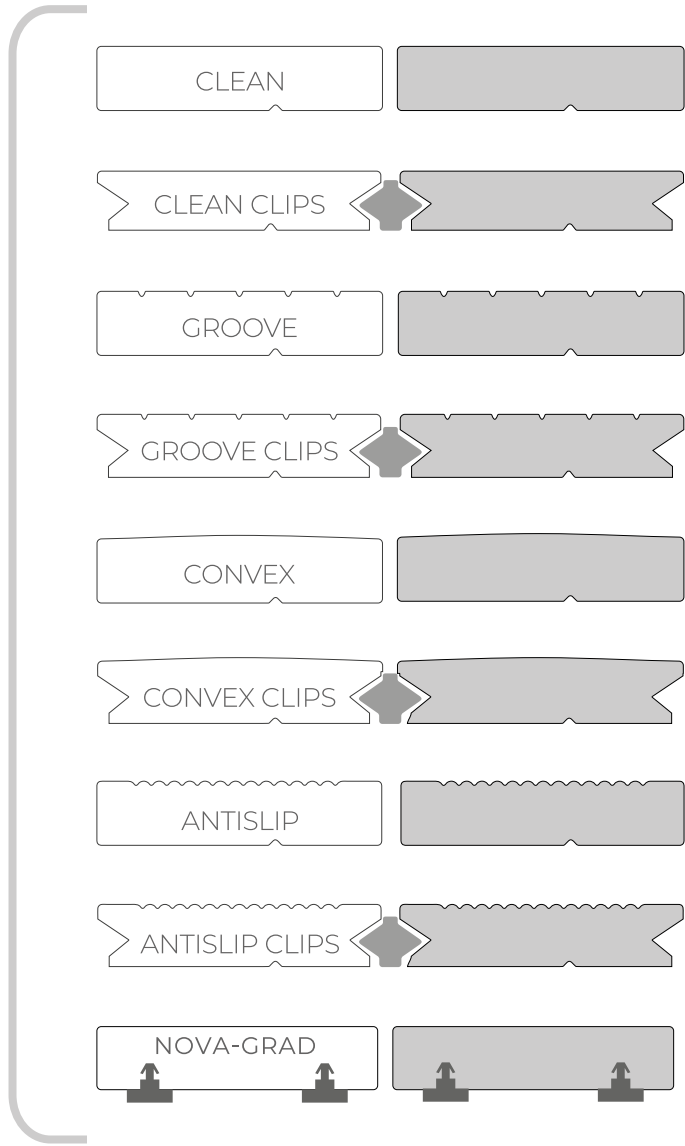

SPECIAL
PROFILES

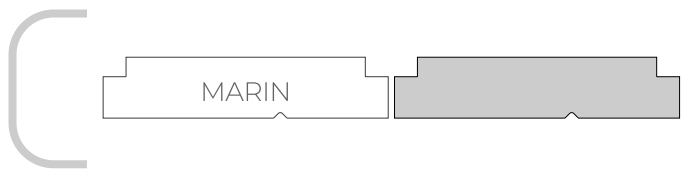



novawood[®]
INTERIORS & EXTERIORS

— **NOVA-CURLY DECKING**

novathermowood[®]

Standing out with its innovative perspective in the sector, Novawood has gone beyond the ordinary with its designed products in outdoor decking applications, taking into account the different expectations for boutique work needs.



Nova-Curly



Nova-Curly decking gives a unique impression at every glance with its curved structure.



Nova-Hexagon



With the geometric design of Nova-Hexagon decking, your private areas get a completely different look.

PRODUCTS	WOOD SPECIE	QUALITY	THICKNESS (mm)	WIDTH (mm)	LENGTH (mm)
CURLY	Thermowood Ash	Extra	21 / 25	100	1200 / 1800 / 2100 / 2400
HEXAGON	Thermowood Ash	Extra	21 / 25	75 / 125	1000 / 1200
CURLY	Thermowood Pine	A	25	88	1200 / 1800 / 2100 / 2400
HEXAGON	Thermowood Pine	A	25	63 / 113	1000 / 1200



novawood[®]
INTERIORS & EXTERIORS

— **NOVA-TILE DECKING**

novathermowood[®]



novathermowood**** Made of 100% natural material, Nova-Tile decking is stylish, environmentally friendly, healthy, durable, and simultaneously it is easy to install, disassemble, maintain and clean.

Bosphorus Hotel



The special plastic of Nova-Tile Decking, which is mounted on highly densed polyethylene plastic with stainless steel screws, prevents the water accumulation under the wood on the wet floors. Specially designed clips system lowers assembly costs while making installation easier. It helps you to save time, and also to prevent dust and dirt. The fact that it can be disassembled as fast and practical as it is assembled allows you to easily remove Nova-Tile decking in case of a possible location change. Nova-Tile deckings offer a wide range of usage areas such as poolside, gardens, walkways, terraces and balconies, saunas and spas, cafes and restaurants. It is stable, smooth and suitable for use in all weather conditions, offers a reliable and classy living spaces.

WOOD SPECIE	THICKNESS (mm)	TILE SIZE (mm)
Thermowood Ash	32 (17 +15)	300 x 300 300 x 600
Thermowood Iroko	32 (17 + 15)	300 x 300 300 x 600

The inner parts of the tile can have a width of 55 or 70 mm.
The thickness of the wood is 17 mm, and the thickness of the lower plastic material is 15 mm.



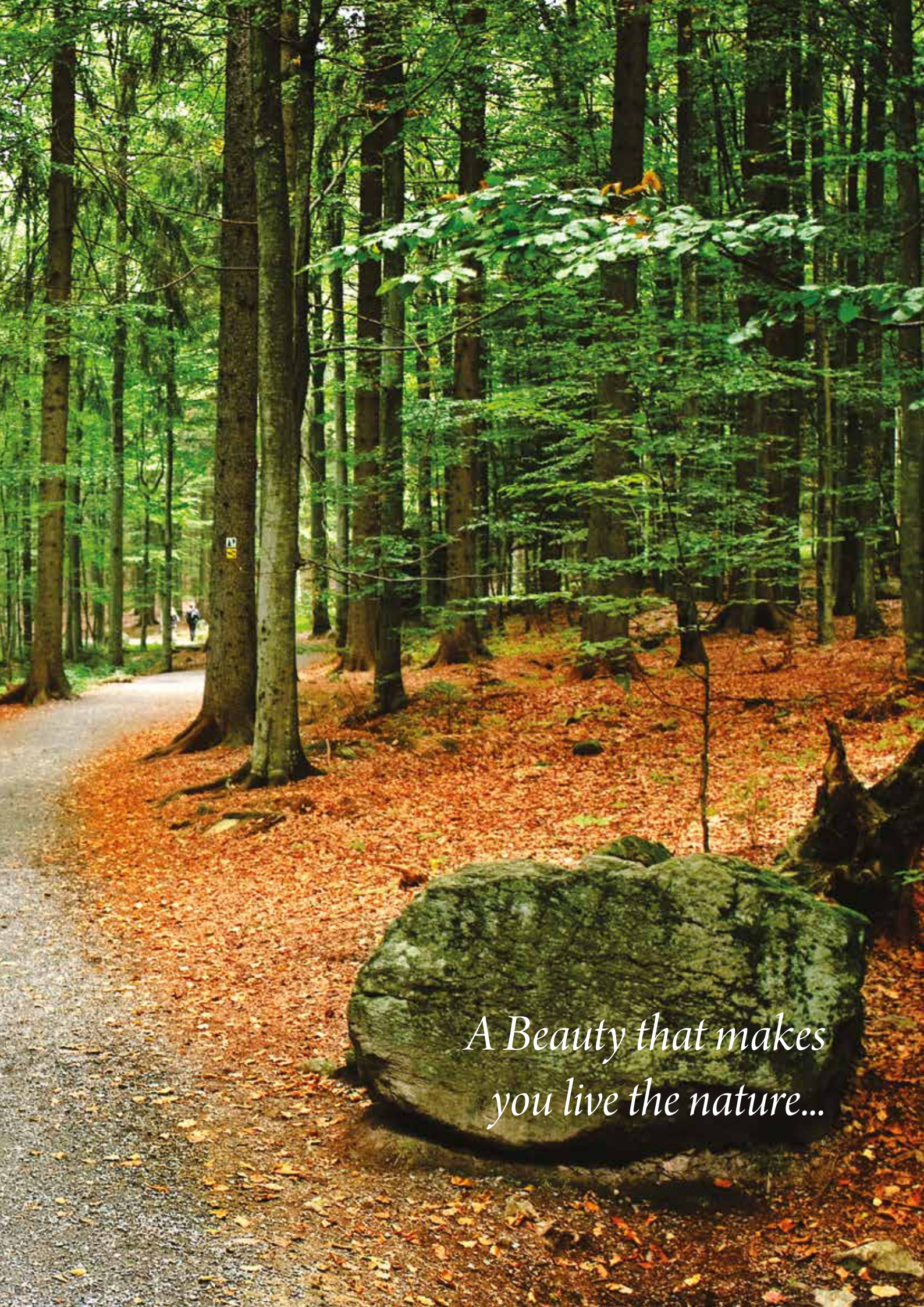

*A Beauty that makes
you live the nature...*



The right application starts
with the right choices.



CUSTOM SOLUTIONS

CARCASS

Novawood creates carcass solutions in various sizes in order to ensure that the substructure of your decking and cladding are the right products that you get the optimum benefit in your applications. Carcass forms the base of the decking and cladding, which necessitates utmost care in the selection of materials. The right decking and cladding application starts with choosing the right carcass.

If the products and substructure materials are at the same moisture content levels, they will have same working tendency, thus the most efficient solution will be obtained. Novathermowood carcass materials, which are generally produced from ash, iroko and pine trees, become much more durable with fingerjoint and lamination processes and can be produced in larger sizes.

► Cladding Carcass Detail



► Carcass Profiles



► Decking Carcass Detail



WOOD SPECIE	THICKNESS (mm)	WIDTH (mm)	LENGTH (mm)
TMT Ash	20 / 25 / 40	40 / 65	1200 - 3000
TMT Ash (FJ / Laminated)	40	40 / 65	3000 - 4000
TMT Iroko	20 / 25 / 40	25 / 55 / 90	1000 - 3000
TMT Iroko (FJ / Laminated)	40	40	3000 - 4000
TMT Pine (A Grade)	19 / 26 / 42	42 / 55 / 65 / 90	1000 - 5100
Kiln Dried Iroko	20 / 25 / 40	45	1000 - 3000

END-MATCHING

Novawood has adopted the principle of producing the details for the perfect installation on decking and facades with the innovative solutions. This unique design and application detail developed in this sense is just one of the smart solutions that Novawood offers.

End matching makes the structural strength and fixation perfect with the formation of a full bearing conditions on the heads, in addition to providing easy assembly during the application, aesthetic continuity and integrity.

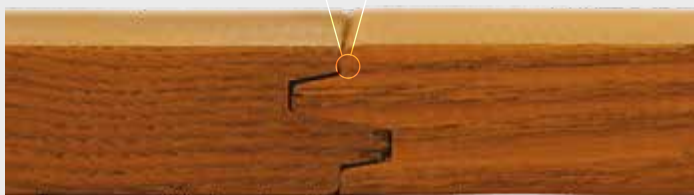





SCREW

Correct selection of screws will prevent the rust formation and provide trouble-free assembly. In decking and cladding applications; it is recommended to use A2 stainless coded screws or nails for visible or invisible connections. In these applications, it is important to use screws suitable for the cladding and carcass.

For invisible clips connections, countersunk half-threaded or fully threaded A2 stainless steel screws suitable for the clips and wood should be preferred.

It is recommended to use A2 stainless steel screws with the cylinder head or decorative head fixation threads for the visible applications. It is recommended to use screws made of stainless steel, coded A4 stainless, for places exposed to the sea water.

Screw	Screw Ø (mm)	Screw Length (mm)	Head Ø (mm)
 Clips-on mounting screw	3.5	35 / 40	7.0
 Clips-on mounting screw	4.0	40 / 50	8.0
 Top mounting screw	5.0	56	10.0
 Top mounting screw	5.0	40 / 50 / 60 70 / 80	7.0

NOVA-PEDESTAL

► What is Nova- Pedestal?

Nova-Pedestals are raised floor legs which can be used indoors and outdoors, with an adjustable height between 14-725 mm. Preferably used when decking applications are carried out, pedestal supports are particularly needed when elevation from the ground is required, providing easy installation due to height adjustability.



$$\text{Number of pedestals to be used} = \frac{1}{\text{Carcass distance (m)} \times \text{Pedestal distance (m)}}$$

NOVA CODE	HEIGHT (mm)
NSP1	14
NSP2	18
N0	15-30
N1	26-35
N2	35-50
N3	50-75
N4	75-110
N5	110-180
N6	140-220
N7	205-295
N8	205-330
N9	270-390
N10	270-440
N11	340-500
N12	340-550
N13	405-615
N14	405-660
N15	470-725

► Advantages of Nova-Pedestal Systems

- It has high load resistance. (Min 1000 kg / piece)
- It provides fast drainage due to its open joint system, thereby there is no accumulation of water on the coating and no water ponding.
- Installation and wiring can be done in the space between the floor and the coating.
- It is easy to apply, fast and economical
- It has high resistant to all weather conditions.



LAMINATION

Nova-laminated products enable to achieve desired dimensions for applications that require larger sizes of wood such as underconstruction, pergola, door and window scantlings, and hand rail. Novawood laminated boards are bonded together with MUF (Melamine Urea Formaldehyde) glue, which is an enduring glue type for the outdoor weather conditions. Enjoy the privilege of reaching dimensions that are not possible to reach in traditional wood applications through the lamination process.



FINGER JOINT

Finger-joint materials are produced in our production lines reserved only for this process. The teeth opened on the heads of the wood with special profile blades are combined with MUF (Melamine-Urea Formaldehyde) adhesives suitable for the outdoor usage. As a result of this process, we receive longer and fixed length products. You will be amazed by the visual feast consisting of the combination of the short pieces of 20 cm and 100 cm with MUF glue. Products with finger joints can be easily used in the sunshades, claddings, carcasses and pergolas.



Pi-Clips / **Pi-2 Clips**

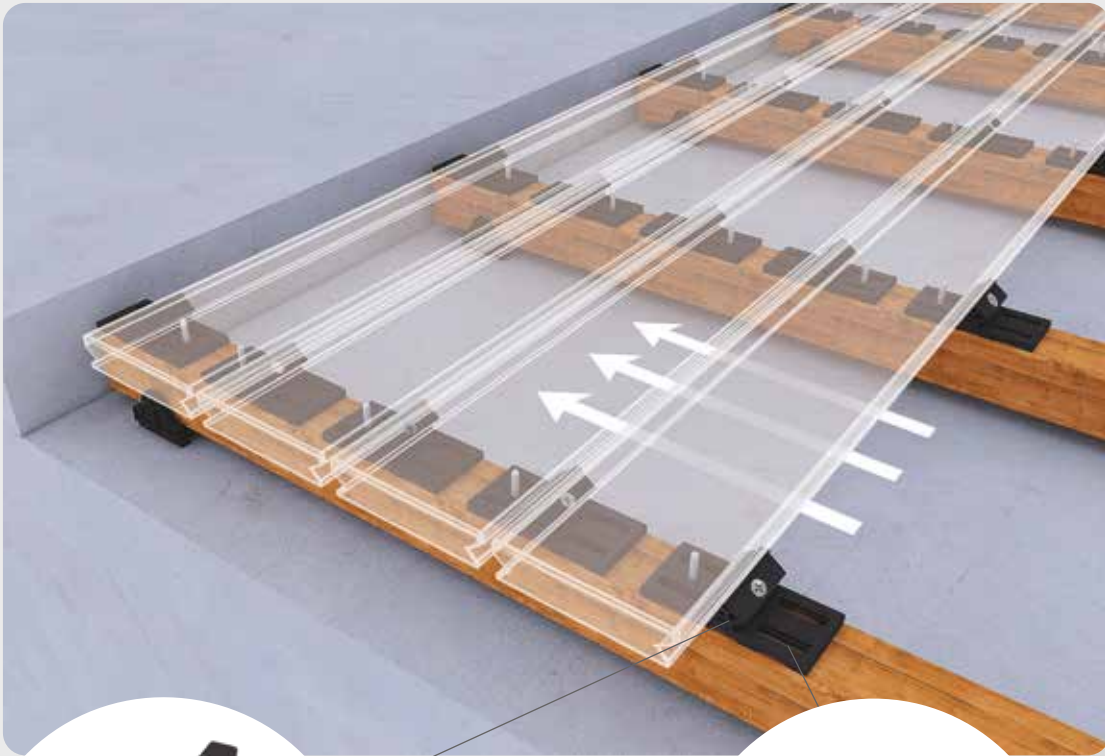

Pi-Clips



Pi-2 Clips

Pi-Clips and Pi-2 Clips are hidden mounting detail apparatus produced from PA6 material, which are specially designed for undesirable situations with screw mounting on the decking. Pi-clips are resistant to all kinds of outdoor weather conditions.

Pi-Clips facilitates installation by automatically providing 4.5 mm gap required between the deckings. Pi-2 Clips, on the other hand, is placed between the two decks with its special double-winged structure and raises the decking 5 mm above the carcass and provides the air circulation which extends the life of the wood. As a result of these advantages, Pi clips become an indispensable, smart solution for the decking applications.



Pi-Takoz

With the new and specially designed Pi-Takoz products installed under the carcasses in the decking applications, its is possible to cut the contact of the carcasses from the ground and to allow the air and water to flow smoothly. Therefore, Pi-Takoz prevents the carcasses from sinking in the water accumulation at the certain level that may form on the ground. Thus, decking applications become much more permanent and long-lasting. With this feature that supports ease of application and durability, Pi-Takoz are ready to be an essential part of your decking applications!



Pi-Takoz



Pi-Metal Clips

For those who want to use metal clips, we recommend our Pi-Metal Clips that offer a seamless solution in decking applications and can be used easily in all kinds of decking products. Pi-Metal Clips, which raise the deckings 5 mm over the carcass with its winged structure, provide air circulation as it should be. Thus, decking and carcasses can dry easily. This situation further extends the life of the wood.

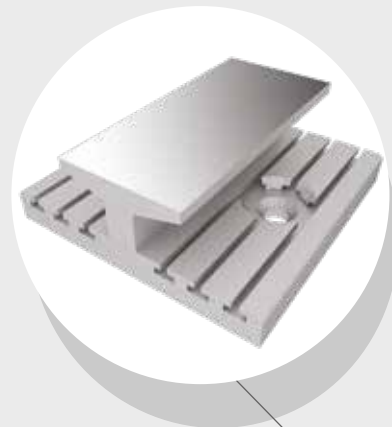

Pi-Metal Clips

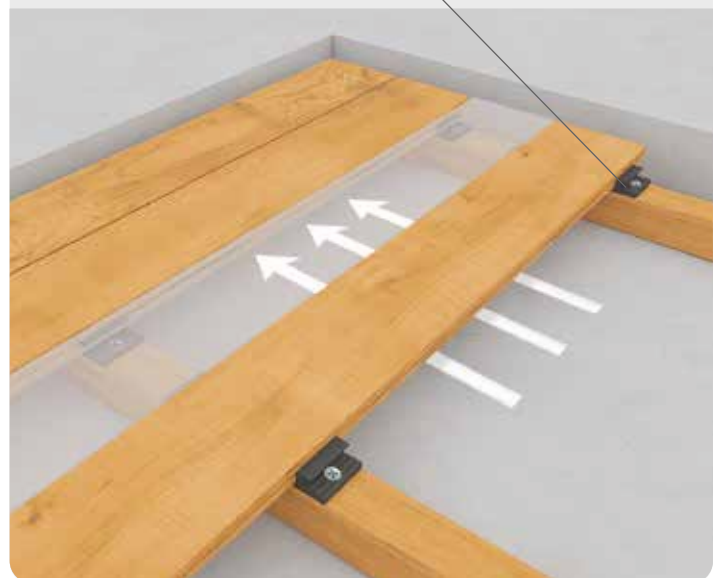

Pi-Fix / **Pi-Fixal**

Pi-Fix, is one of our practical clips solutions that you can easily use in cladding, sunshade and ceiling applications. It is a hidden and practical mounting element with an aluminum carcass (Pi-Fixal). It provides “push-fit and locking” with the help of its unique form and the centering and mouthing feature. It allows local change and renewal without damaging the carcass. Pi-Fix is used in indoor and outdoor applications, by mounting on the carcass at certain desired distances. The distance setting can be adjusted according to the project and usage request. It allows the assembly of the products of all sizes. The design supports the flexible mounting model.

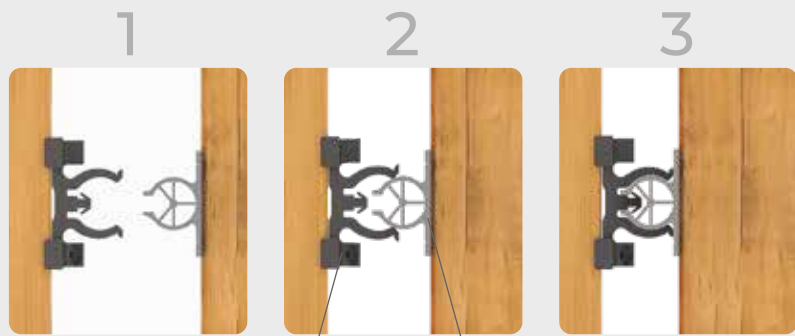

novathermowood
Sunshade

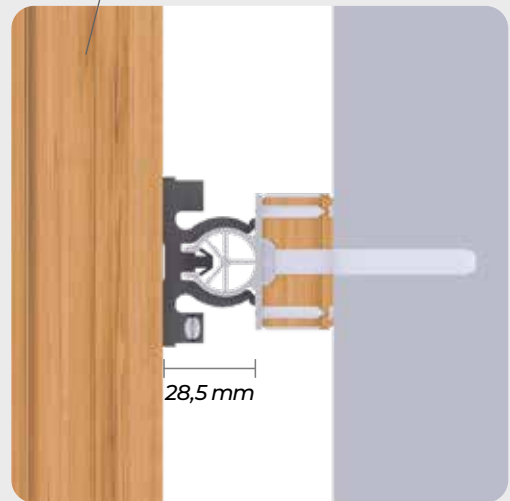

Pi-Fix



Pi-Fixal

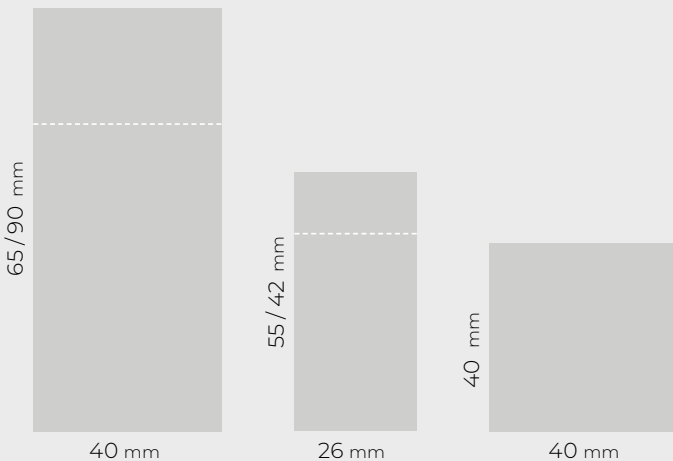

Pi-Zeta

nova**thermowood**
Carcass



Experience the difference of our specially designed Pi-Zeta clips, which provide faster and easier installation in facade applications, allow air circulation by raising the facades by 5 mm over the carcass, and enable independent boards of cladding! In case of any problem that may occur in the wood, the damaged part can be easily replaced with a new one due to the cladding boards that are independent from each other. Pi-Zeta clips allow the air and water passage by providing standard gaps automatically between the facades from the moment of application.

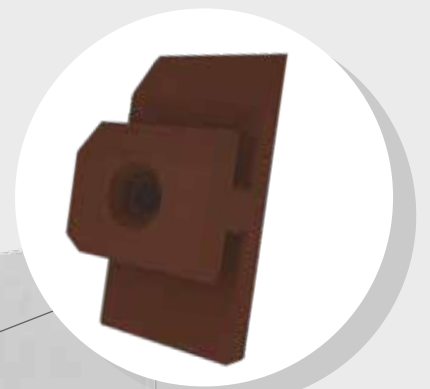

Pi-Zeta

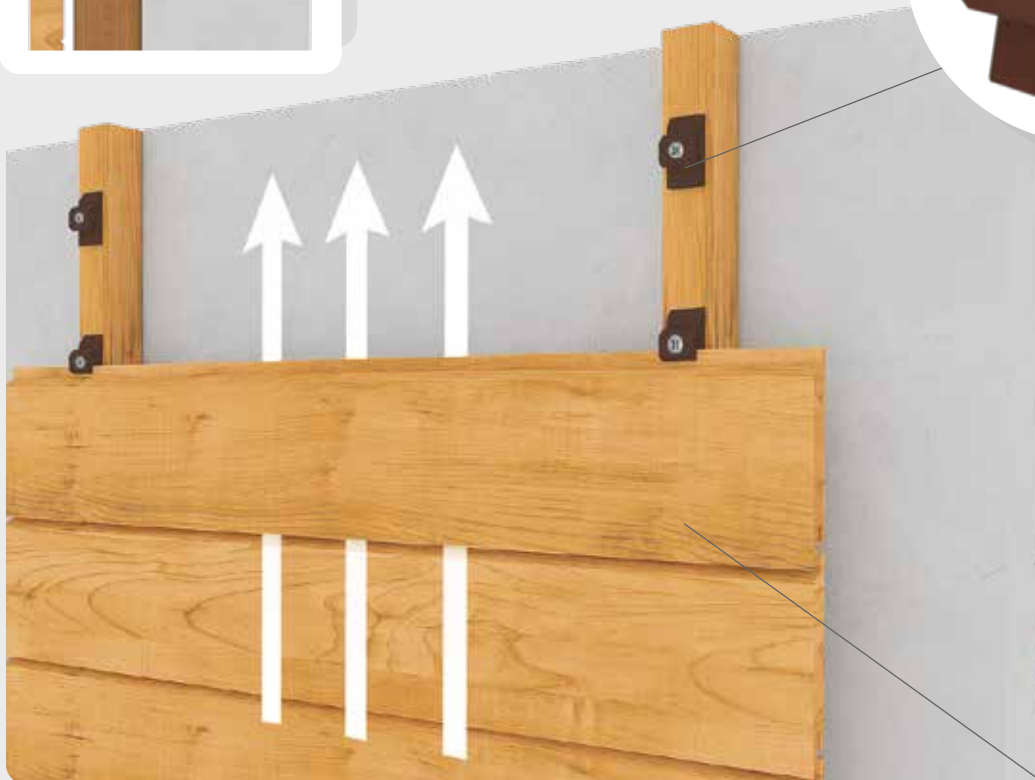

nova**thermowood**
Cladding







We add value to the wood with special surface touches.



SURFACE APPLICATIONS

— I NOVA-CROCO

NOVA-CROCO



Shou Sugi Ban, derives from an ancient Japanese exterior cladding treatment used to preserve the wood by charring it with the fire. The process forms a carbon layer on the exterior of the boards which protects the timber and reduces the maintenance need. Unlike this manual burning process, Nova-Croco is created with a unique process in a production line where the temperature rate is standardized. The special black texture of Nova-Croco is created not only by burning, but by applying a special solution in advance. Afterwards the oil treatment is applied to the surface with a special varnish compatible

with the exterior conditions. Thus, a semi-dull glossy appearance is obtained on the surface and the surface breakages are minimized. Discover Nova-Croco's nicely curved surface, unique beauty and special black texture.

*For ash and pine trees, Nova-Croco application can be made in the desired size.



novathermowood**** The new trend of facade cladding is waiting for you to be used in your black surface Nova-Croco designs and applications.

NOVA-SAHARA

We are ready to go beyond the ordinary with our Sahara surface. With its wavy texture reminiscent of the desert sands, Nova-Sahara provides massage comfort in every step you take and makes you feel the privilege of being different and special.

*It can be applied to all sizes and thicknesses.



NOVA-VINTAGE

Nova-Vintage surface treatment brings the rustic nature to your spaces with Novawood quality. By adding a rustic-looking effect, we harmonize the natural space designs with the nature. Nova-Vintage surface finishes are obtained with a special technology. The appearance of Nova-Vintage is attained with the special knots, cracks and tree essence effects that have been aged in the wood from the first day.



NOVA-BRUSHED

Nova-Brushed surface highlights the texture of the wood in decking and cladding products, allowing you to feel the naturalness more in the living spaces. The soft parts of the annual rings which are inherited in the wood are removed by applying a secondary process with a special brushing method. Thus, we make the hard texture of the tree more noticeable. Using this method even on the woods with covering paints emphasize the naturalness and the texture of the wood itself.

*It can be applied to all sizes and thicknesses.

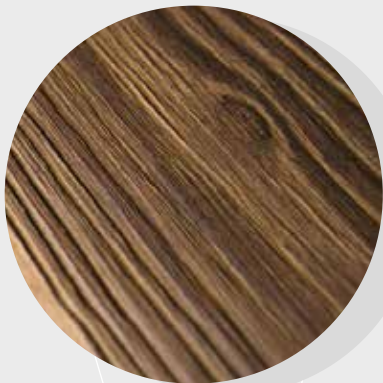

COATING / OILING

In order to delay the color fadings caused by the UV rays, to protect against the stains caused by the rain and to prevent the formation of superficial and head cracks, it is important that the cladding and decking products undergo a proper surface treatment. Therefore, we can perform the lubrication process in our factory.

It is crucial that:

- The coatings or oils to be used are suitable for Thermowood and exotic woods
- The resin structure is suitable for outdoor use and is resistant to yellowing
- The whole system is water repellent and vapor permeable
- The products used contain pigments that are resistant to UV rays



Novawood produces window scantling profiles with its high technology infrastructure and special wood classification. Our difference comes from the fact that the scantling profiles are obtained from novathermowood treated woods.

They can be produced as fingerjointed layers as well as solid layers. The scantling profiles produced with finger jointed and 3 layers have been transformed into a product with minimized working tendency (twisting, bending) and providing the highest level of stability due to the thermowood process.



Feel the privilege of turning back to the "natural" with different tree types and window scantlings produced in different sizes.



According to the international product specifications in window scantling sector, there are 3 types of productions that Novawood offers.

DKD: Outer layers Solid, middle layer Fingerjointed

DKK: One side Solid, middle and bottom layers Fingerjointed

KKK: All layers Fingerjointed

WOOD SPECIE	THICKNESS (mm)	WIDTH (mm)	LENGTH (mm)
Pine	54 / 75	86 / 110	1000 - 5100
Ash	60 / 75	86 / 110	1000 - 3000
Beech	75	86 / 110	1000 - 3000



The wood of the doors used in outdoors must also be resistant to the outdoor conditions. Meanwhile, novathermowood door materials with thermowood treatment and increased stability come into prominence.

Novawood supplies raw materials for solid doors as well as offering novathermowood products in different thicknesses for surface coating of the steel doors.



WOOD SPECIE	THICKNESS (mm)	WIDTH (mm)	LENGTH (mm)
Ash	8 / 10 / 20	90 / 115 / 130	1000 - 3000
Pine	8 / 10 / 20	90 / 115 / 130	1000 - 5100
Ayous	8 / 10 / 20	90 / 115 / 130	800 - 4000
Beech	8 / 10 / 20	90 / 115 / 130	800 - 3000
Oak	8 / 10 / 20	90 / 115 / 130	800 - 3000





We go one step further in the landscape and combine the green areas with the warmth and naturalness of the wood.



The use of Novathermowood in the production of benches, seating areas and urban furnitures for park and garden areas provides an extra durability. In addition, we provide all the necessary support for your special designs needed in the green areas. With Novathermowood product selections, it becomes possible to soften the outdoor decorations and increase their durability by ensuring the integrity between the green and the wood.



Novawood carefully purchases selected raw materials while producing its products. In order to meet customer's demand for timber, we are also providing our carefully selected raw materials in the form of timber. Our timber stocks consisting of the hard and soft trees grown in North America, Africa and the Baltic countries are all available.



novathermowood

We are proud to contribute to many architectural structures and special projects in the international platform with our exclusive products, always revealing the Novawood difference in the wood industry.

WOOD SPECIE	THICKNESS (mm)	WIDTH (mm)	LENGTH (mm)
TMT Pine	19	100	2400 - 5100
TMT Pine	25	100 / 125 / 150	2400 - 5100
TMT Pine	32	100 / 125 / 150	2400 - 5100
TMT Pine	50	100 / 125 / 150	2400 - 5100
TMT Iroko	25 / 50	100	1000 - 3000
TMT Iroko	26	130	1000 - 3000
TMT Iroko	33	100 / 130	1000 - 3000
TMT Ayous	25 / 33 / 50	100 / 125 / 150	2100 - 4500
TMT Ash	26	102 / 127 / 152 / 178 / 203	1200 - 3600
TMT Ash	32	102 / 127 / 152 / 178 / 203	1200 - 3600
TMT Ash	38	152 / 178	1200 - 3600
TMT Ash	52	102 / 152	1200 - 3600
TMT Tulipwood	26 / 32 / 52	152 / 178	2400 - 4500
TMT Red Oak	26	152 / 178	1200 - 3600
TMT Maple	26	152	1200 - 3600
TMT Beech	25 / 32 / 50	100 / 125 / 150	1200 - 3000

*Novawood bridge expanding from
Istanbul to the whole world*





Istanbul - Bosphorus Bridge

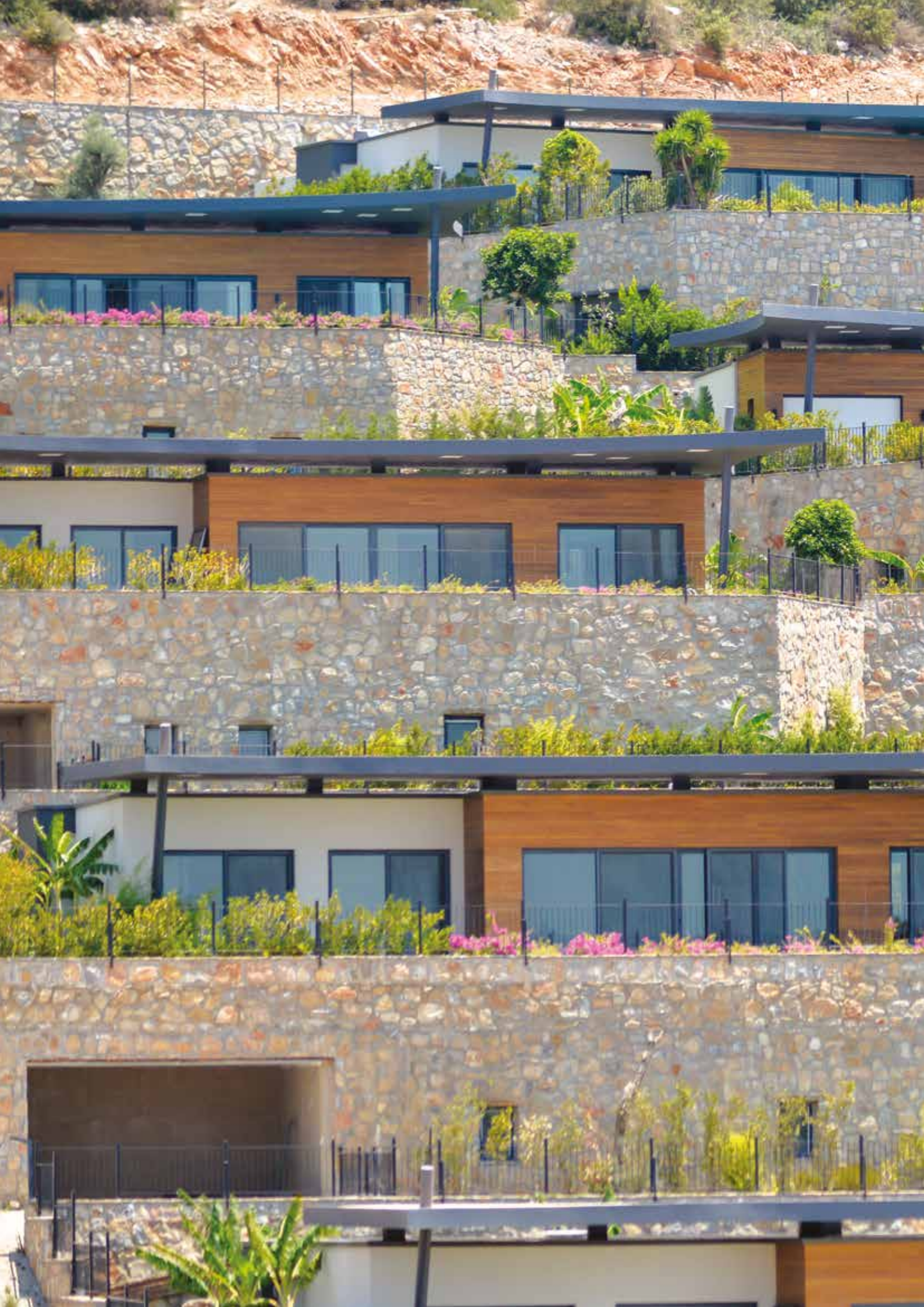

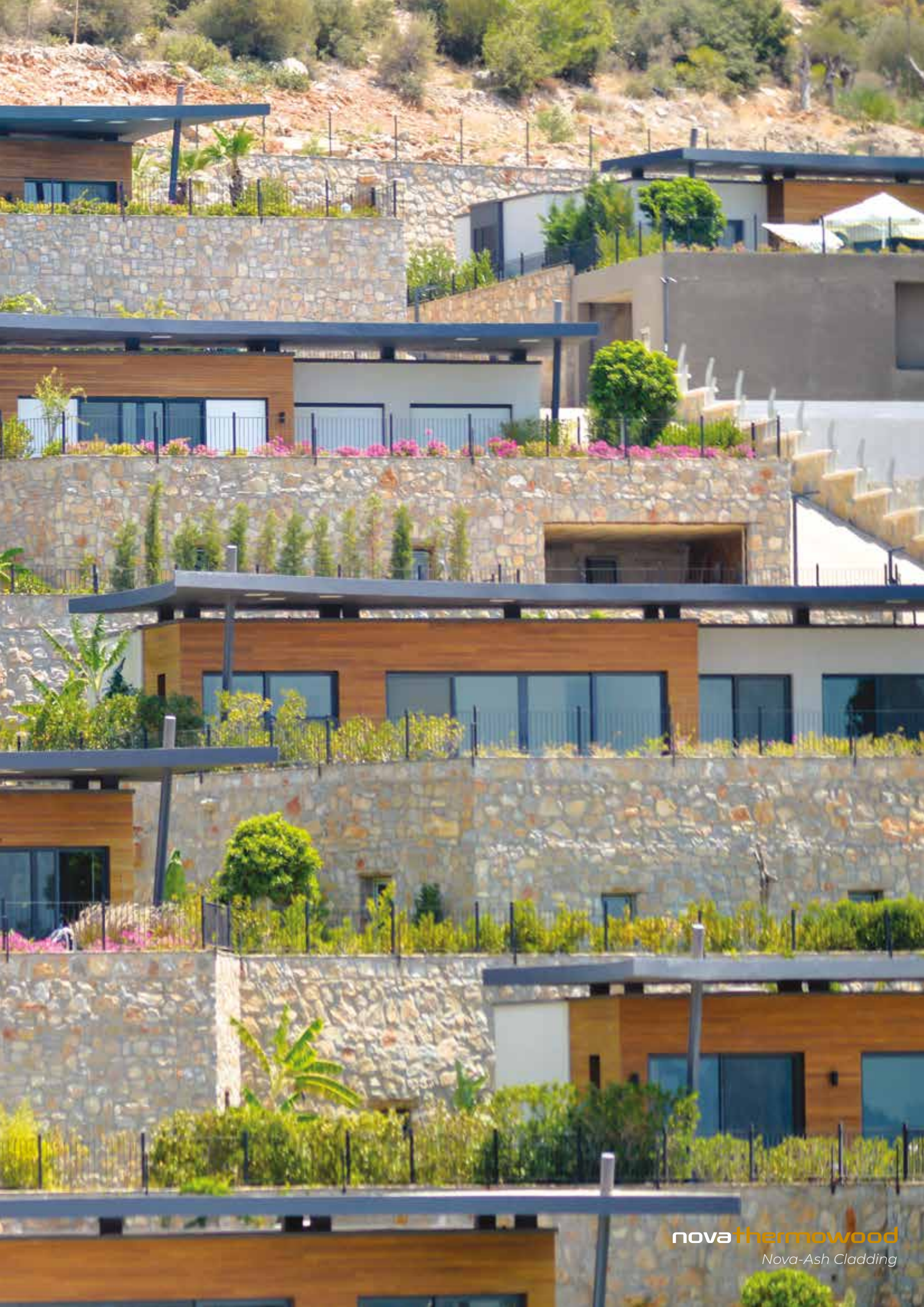

































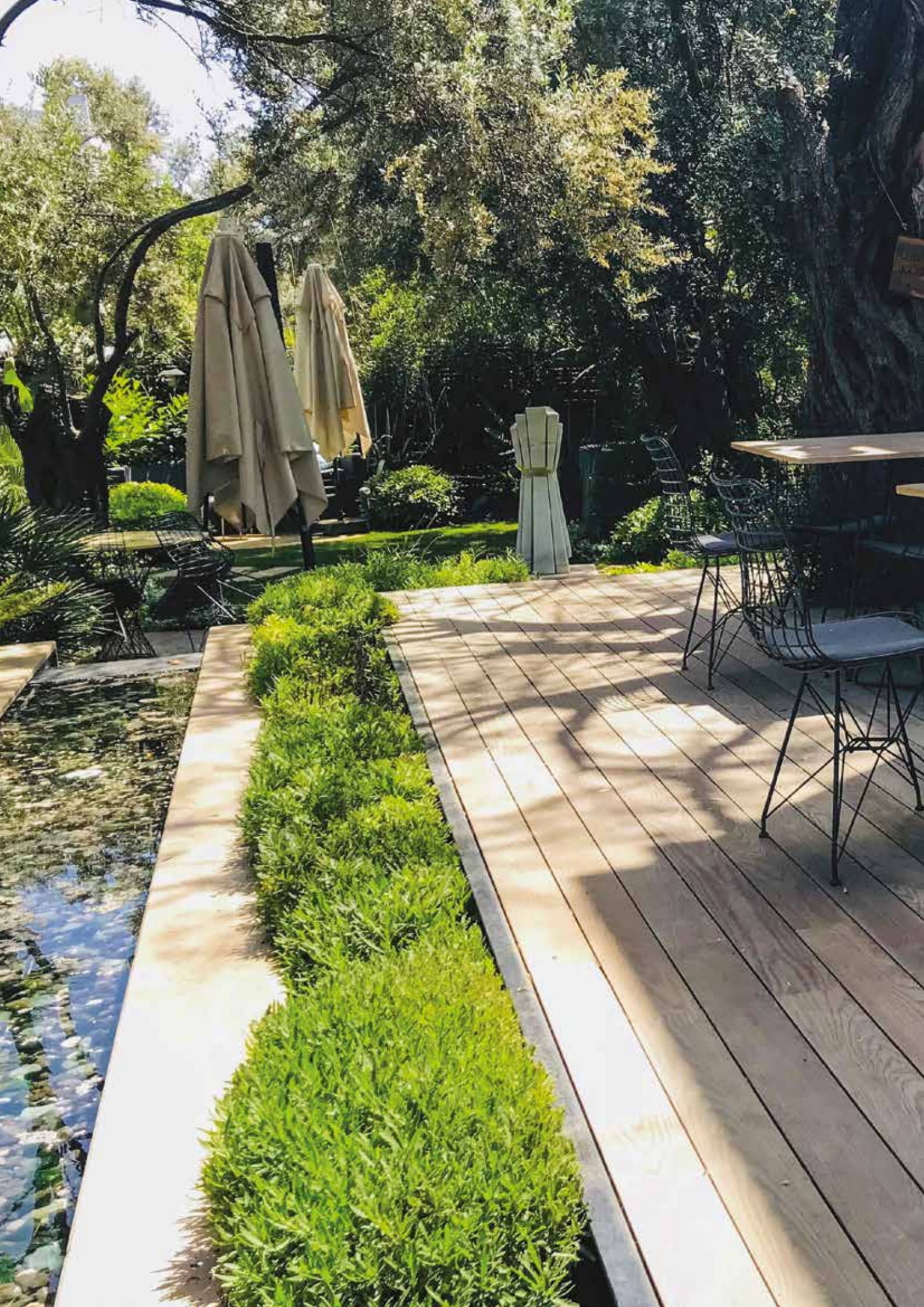











novathermowood

Nova-Pine Sunshade





novathermowood
Nova-Pine Cladding







B | blok





novathermowood

Nova-Ash Decking





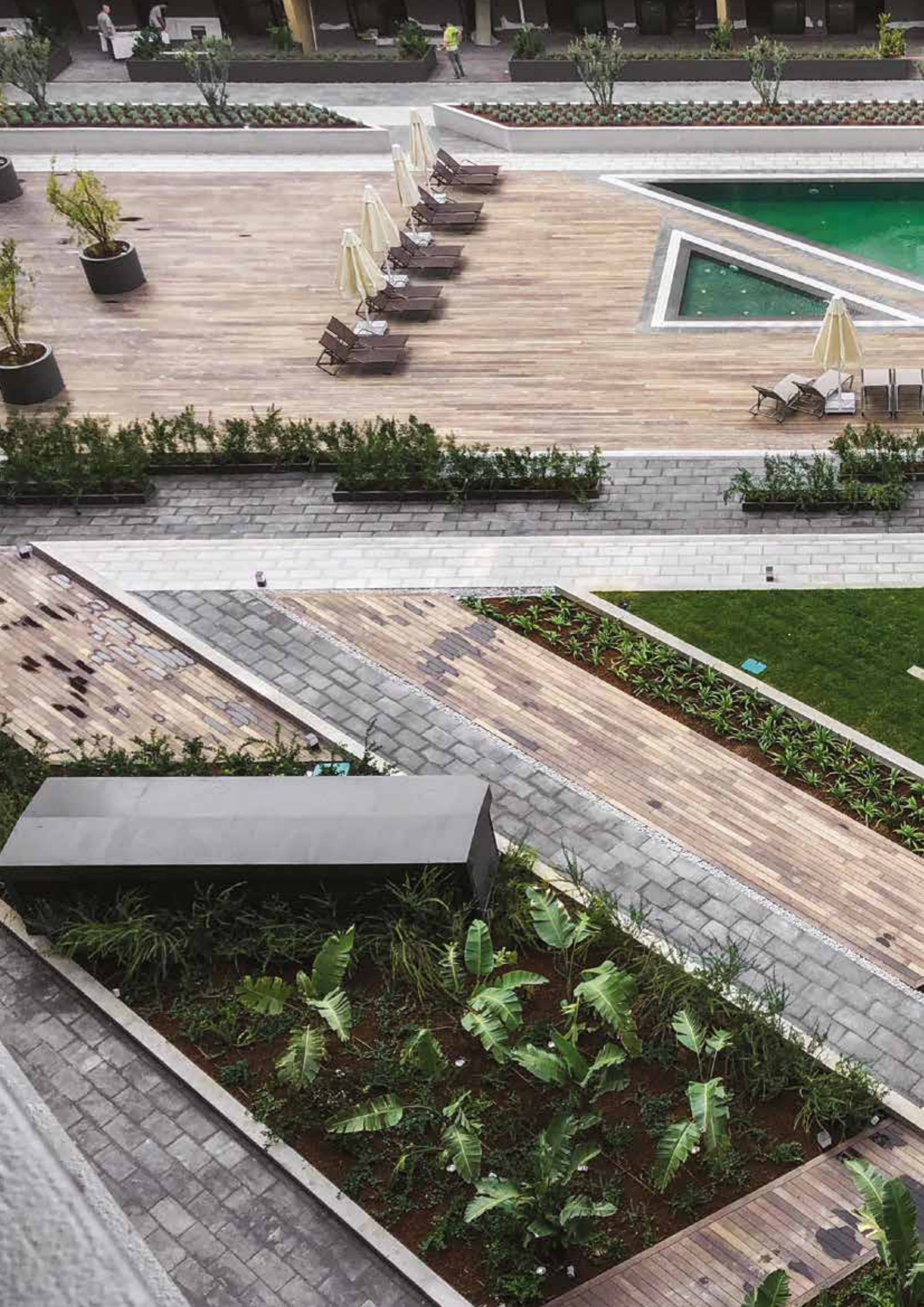

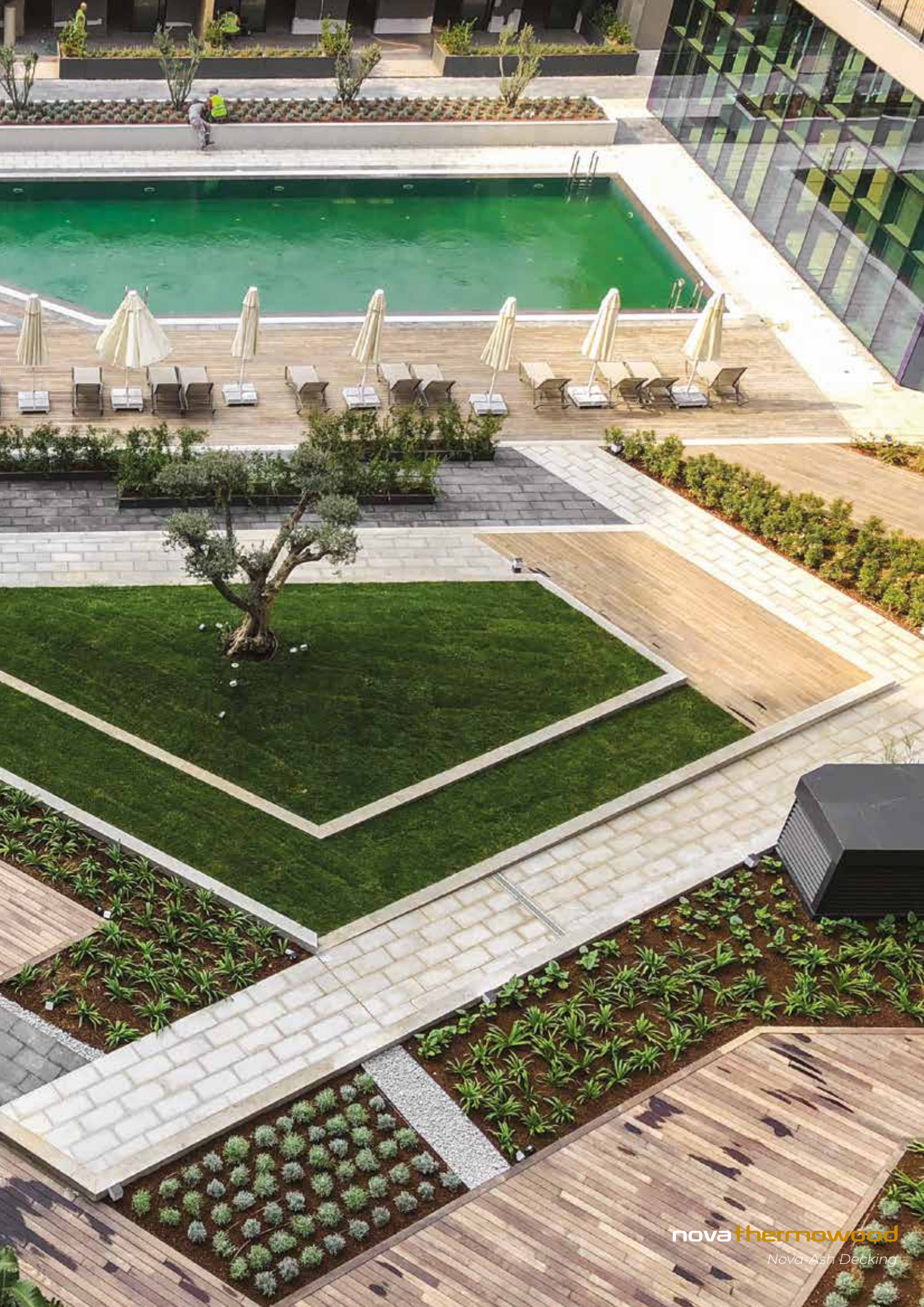







- AFGHANISTAN
- ALBANIA
- ANTARTICA
- AUSTRIA
- BAHRAIN
- BELGIUM
- BRITAIN
- BULGARIA
- CANADA
- CHINA
- CROATIA
- CYPRUS
- CZECH REPUBLIC
- DENMARK
- DJIBOUTI
- EGYPT
- ESTONIA
- FINLAND
- FRANCE
- GEORGIA
- GERMANY
- GHANA
- GREECE
- HONG KONG
- HUNGARY
- INDIA
- IRANIAN
- IRAQ
- ISRAEL
- ITALY
- JAPAN
- JORDAN
- KAZAKHISTAN
- KOSOVO
- KUWAIT
- LEBANON
- LIBYA
- LIECHTENSTEIN
- MEXICAN
- MOROCCO
- NETHERLANDS
- NORWAY
- OMAN
- PAKISTAN
- PALESTINE
- PORTUGAL
- ROMANIA
- RUSSIA
- SAUDI ARABIA
- SERBIA
- SINGAPORE
- SLOVAKIA
- SOUTH KOREA
- SPAIN
- SWEDEN
- SWITZERLAND
- TAJIKISTAN
- UAE
- UGANDA
- UKRAINE
- USA
- UZBEKISTAN
- VIETNAMESE







Natural State of Wood