



WOLFIN

MEMBRANES

DISTRIBUTED BY **PROJEX** GROUP PTY. LIMITED

WOLFIN WATERPROOFING SYSTEMS -
Designed to meet the highest demands for buildings and flat roofs.

THE COMPLETE WOLFIN PACKAGE

1. The System

The Wolfin Membrane System is a combination of purpose designed termination and mounting accessories with a number of strong, elastic, weldable sheet membrane materials together with a detailing and inspection regime.

For several decades now, Wolfin Membranes have been manufactured with the same unique formulation and consistency. External European institutes monitor the high manufacturing quality.

All membrane types are completely bitumen compatible, have excellent UV and variable temperature behaviour and do not require protection against Australian weather conditions. All membrane types also tolerate light service traffic.

The design philosophy in all cases is completely self-sufficient waterproofing. The systems are all designed to accommodate movement in structures and chemically aggressive environments. Each termination is specially designed for each project.

2. The Installation

The **Wolfin Membrane System** is only installed by Wolfin trained and accredited applicators. All Wolfin installers have completed our extensive training and are subject to tight workmanship supervision and thorough final inspections on all projects.

3. The Quality Assurance

The **Wolfin Membrane System** comes with unique and additional services, which offer the specifier and owner extra peace of mind.

Every installation is signed-off by Wolfin Membranes Australia Pty Ltd, resulting in a single-point warranty on labour and material issued to the building owner and fully supported by the manufacturer.

All detailing work is strictly controlled and reviewed by Wolfin Membranes Australia Pty Ltd.

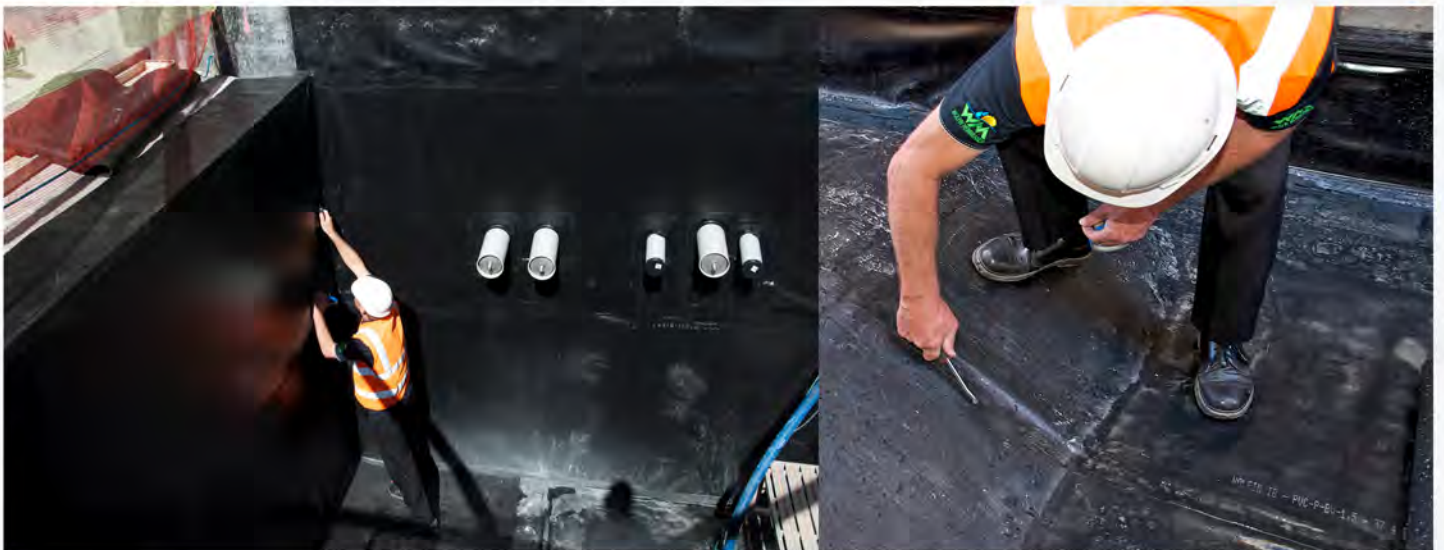

WOLFIN MEMBRANE TYPES

Wolfin IB (unreinforced):

This is the standard un-bonded general-purpose membrane, intended for loose laid applications.

Used for:	<ul style="list-style-type: none">✓ New roofing and tanking situations on any substrate, where wind uplift is prevented by the use of ballast or toppings✓ Waterproofing lightweight structures✓ Waterproofing heavy duty structures, such as bridges✓ Retrofit roofing and tanking: compatible with all existing membrane materials and it is generally not necessary to remove existing failed materials✓ Relief of trapped moisture in retrofit applications: the membrane diffuses vapour✓ May be topped with ANY desired finishing or wearing course materials.
Colour Available:	Light grey or black
Standard Thickness:	1.5mm thick



Cavity flashing and planter box;
Remedial work completed with Wolfin.

WOLFIN MEMBRANE TYPES Continued....

Wolfin GWSK (reinforced):

This is the standard general-purpose **bonded** membrane, intended for all situations. It is a reinforced version of Wolfin IB, coated on one side with a powerful butyl-modified bituminous adhesive. The adhesive is a permanent elastomer and will tolerate thermal and structural movements.

Used for:	<ul style="list-style-type: none">✓ Roofs etc where exposed and subject to wind uplift forces✓ Balconies, terraces and where artificial grass, rubber matting, tiles or similar finishes are to be laid over the membrane✓ Tanking or similar where mechanical damage may be a risk✓ Road bridges: under the wearing course✓ Detailing to the bolts of plant or steel column mountings.
Colour Available:	Light grey or black
Standard Thickness:	2.3mm thick



National Library of Australia.
9,500 sqm of Wolfin installed to the podium slab and planter boxes.

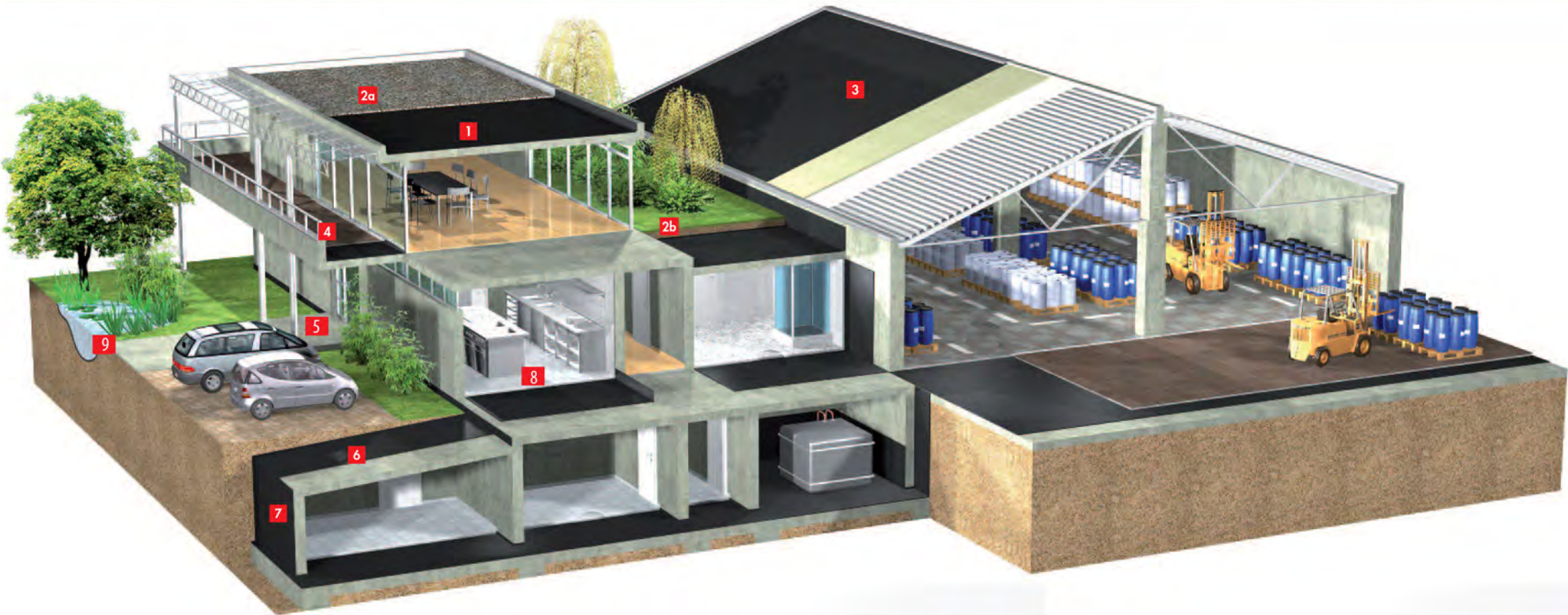

APPLICATIONS OF THE WOLFEN SYSTEM

The PROJEX range of services:

- TECHNICAL CONSULTATION
- DETAILED TECHNICAL DRAWINGS, CAD
- WATERPROOFING ADVICES
- WOLFEN APPLICATORS RECOMENDATION
DEPENDING ON PROJECT
- ONSITE PROJECT SUPPORT

- 1** Flat roof- waterproofing - uncovered, bonded installation
- 2A** Flat roof waterproofing- loose or bonded installation under gravel
- 2B** Flat roof waterproofing- loose bonded installation on green roofs, landscape areas and planters.
- 3** Loose lay, mechanically secured
- 4** Waterproofing of balconies and patios
- 5** Podium Slab
- 6** Waterproofing of cellar ceilings and parking decks
- 7** Waterproofing of retaining walls and basements
- 8** Waterproofing of commercial kitchens
- 9** Waterproofing of garden ponds and fountains

WOLFEN APPLICATIONS

Make sure the membrane you choose fits the purpose & ticks all boxes;

Type of Applications	Areas of application	Specific Attributes of the Wolfen Membrane
1-Typical Applications	<ul style="list-style-type: none"> • Flat Roofs • Terraces • Podiums • Decks • Balconies • Cavity Flashings 	<ul style="list-style-type: none"> • UV Stable • Can be laid over damp substrates & failed membranes (incl Bitumen) • Up to 350% elongation
2- Green Applications	<ul style="list-style-type: none"> • Green Roofs • Landscape Areas • Planter Boxes • Green Walls 	<ul style="list-style-type: none"> • Root Resistant (FLL Tested & Certified) • Not affected by standing/ponding water
3- Underground Applications & Water Features	<ul style="list-style-type: none"> • Basements and Tanking • Under-Slabs • Lift-Pits • Retaining Walls • Detention, Retention, Header and Dump Tanks • Fountains • Potable Water Tanks 	<ul style="list-style-type: none"> • Outstanding chemical resistance • Potable water applications • No downtime for curing and ready for immediate service
4 – Coastal & Chemical Application	<ul style="list-style-type: none"> • Locations affected by salt air • Aggressive environment areas 	<ul style="list-style-type: none"> • Excellent chemical resistance • 316L Stainless Steel detailing profiles available
5- Curved Applications	<ul style="list-style-type: none"> • Curved roofs, basements, balconies, etc 	<ul style="list-style-type: none"> • Highly flexible & moldable

The Wolfen Membrane system possesses all these attributes plus more, making it ideal for these typical and critical applications.

WOLFIN SYSTEM COMPONENTS

Wolfinsteel Profiles (P1, P2, P3, P5, P6)

The profiles are cut and press broken to any desired size or shape. Wolfinsteel comprises 24gge galvanised steel with an 0.8mm thick layer of Wolfin factory bonded to one side. It is available in light grey or black, to match the selected membrane.

It is available for:

- ✓ All terminations (other than AF6 below) and intermediate fixings, such as high walls or long spans
- ✓ Integrated cappings and overflashings, which can be decorated if desired with any good quality acrylic or vinyl coating
- ✓ Concrete or masonry: galvanized pin Nylon Anchors
- ✓ Timber, plywood or FC: Mason Ammson wafer head self-tapping screws, gauge and length to individual specification

All installations are finished with an overlaid membrane, encapsulating the fixings. Typical termination detail applications are shown on standard drawings WSD – 1 TO 4. All special/custom installations are to be advised to WMA for fixing selection and other materials may only be used by Applicators with WMA express permission.

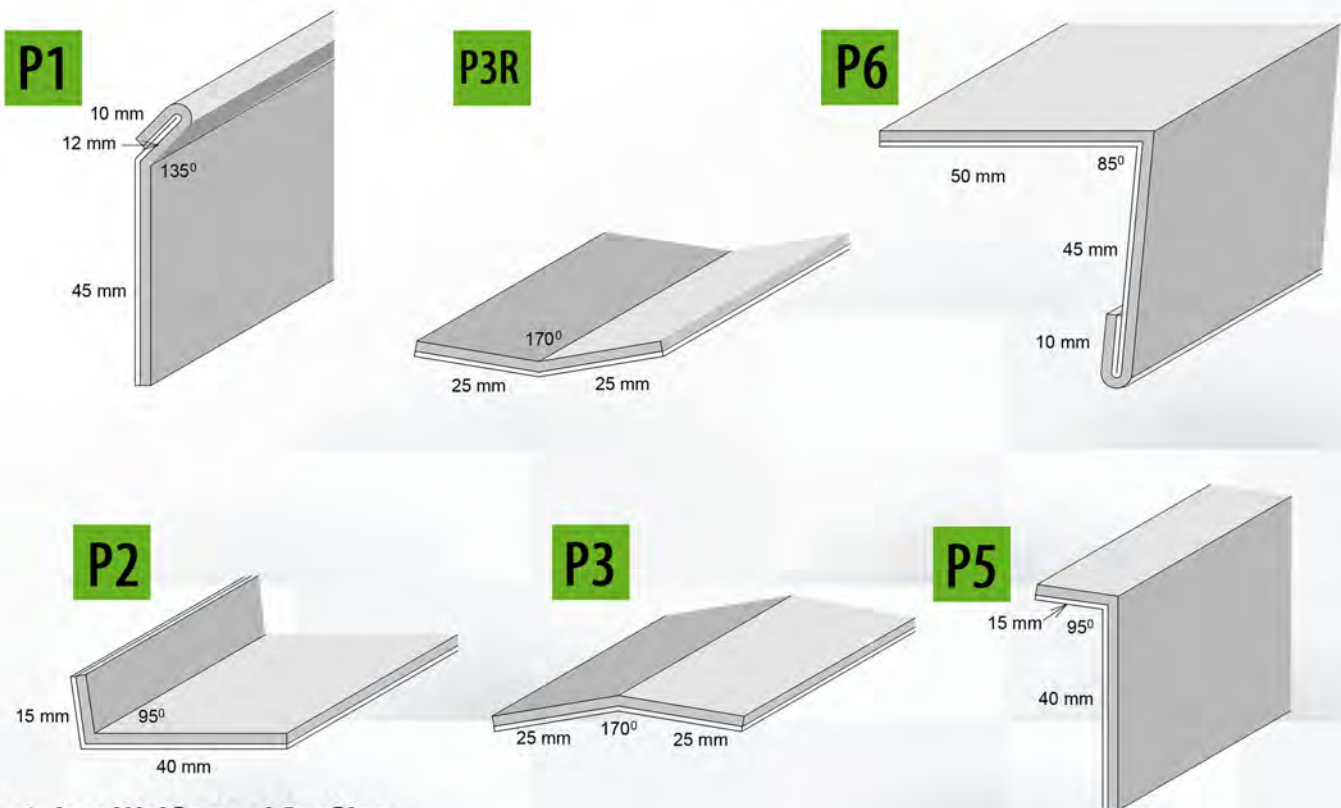

Stainless Wolfinsteel Profiles:

Wolfinsteel is also available in 316L stainless steel black and grey in lieu of galvanised. It is used in marine and/or aggressive environments.

Wolfin Corners:

Preformed Internal and External corners for a tighter neater look. The Wolfin membrane welds direct to the corners.



Wolfin AF6:

It is intended to be cast into concrete to form a highly efficient reglet termination, waterstop either side of cold joints or as an intermediate mounting. It may be fitted to any type of formwork (including steel) and may be used in precast work. Placement to formwork is only performed by a Wolfin Applicator.



Wolfinator Adhesive:

Wolfinator is a structural grade adhesive that has been specially formulated for the bonding of Wolfinsteel to non-absorbent substrates including metals, ceramics, glass, etc. It will also adhere to slightly damp substrates.



Universal Pins:

The Universal Pins are the solution for fastening items directly to the Wolfin Membrane without piercing the membrane itself. The pin has an 80mm diameter base plate, which is made of Wolfin membrane (with a protruding 25mm vertical threaded bar and locking nuts) and can be welded directly to any Wolfin membrane system.



Terotech Spray:

Adhesive for bonding loose laid membranes to the vertical substrates where adhesion is required- skirting tiles etc.



THF:

Tetrahydrofuran cold welding solvent, for cold welding membrane overlaps & membrane connections to PVC pipes.

Sealants:

Generally sealants are only used in the saw-cut (P5) Detail.

Applications	Sealant type
General Purpose:	Seal 'n' Flex 1 one part urethane
Heavy duty (such as below ground and marine or very wet conditions):	Epimax- non shrink grout

Other materials may only be used by Applicators with express WMA permission.

Projex Shockmat:

Shockmat is a reclaimed rubber matting available in 5mm or 10mm thick.

- It is used for:
- ✓ Service walkways and roof plant surrounds
 - ✓ Soundproofing underlay to hard roof and balcony finishes
 - ✓ Membrane protection under heavily reinforced concrete and on rail bridges.



TECHNICAL INFORMATION

- Technical Drawings
- Technical Data Sheets



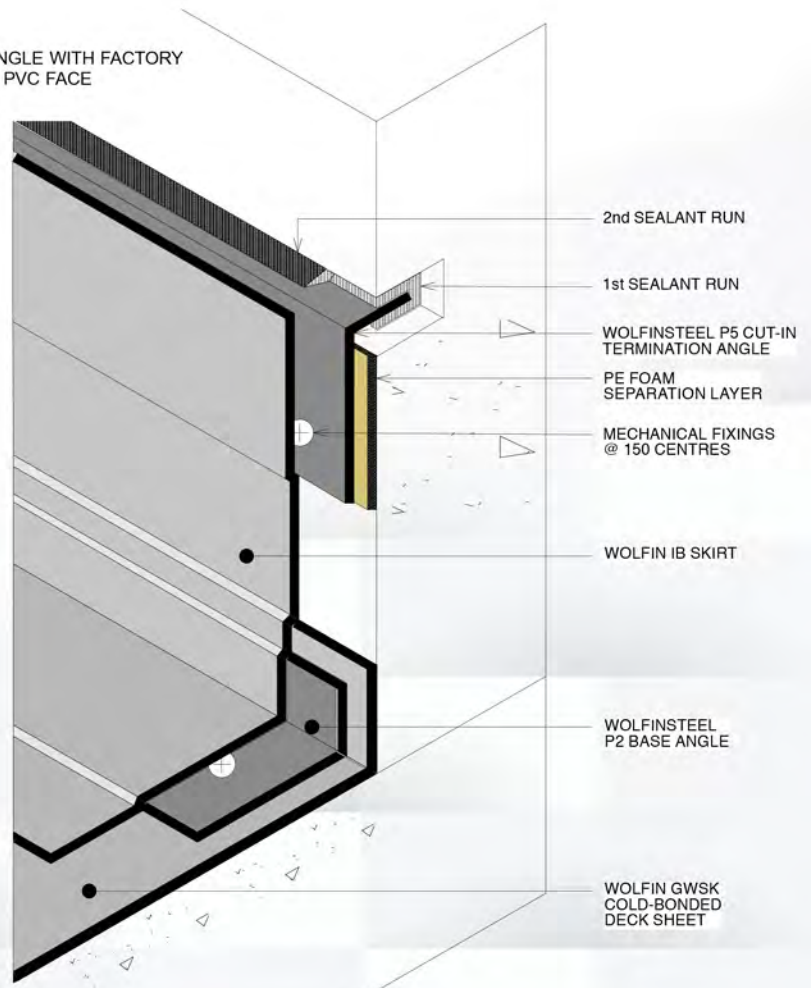
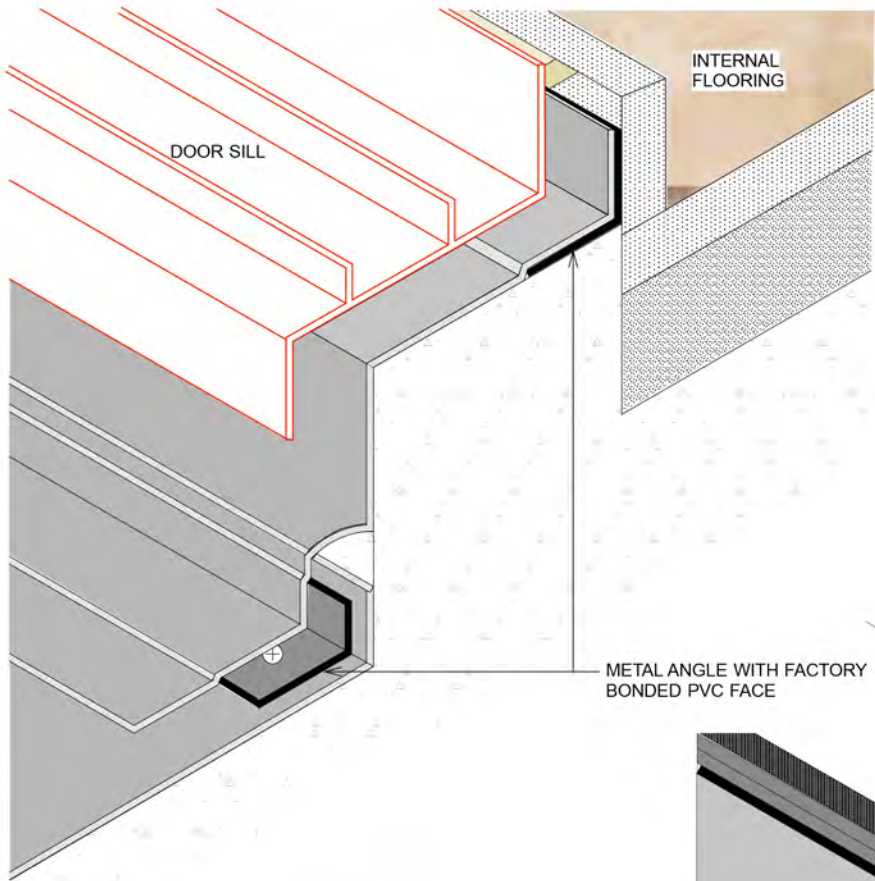

WOLFSTEEL P2 & P5 DETAILS

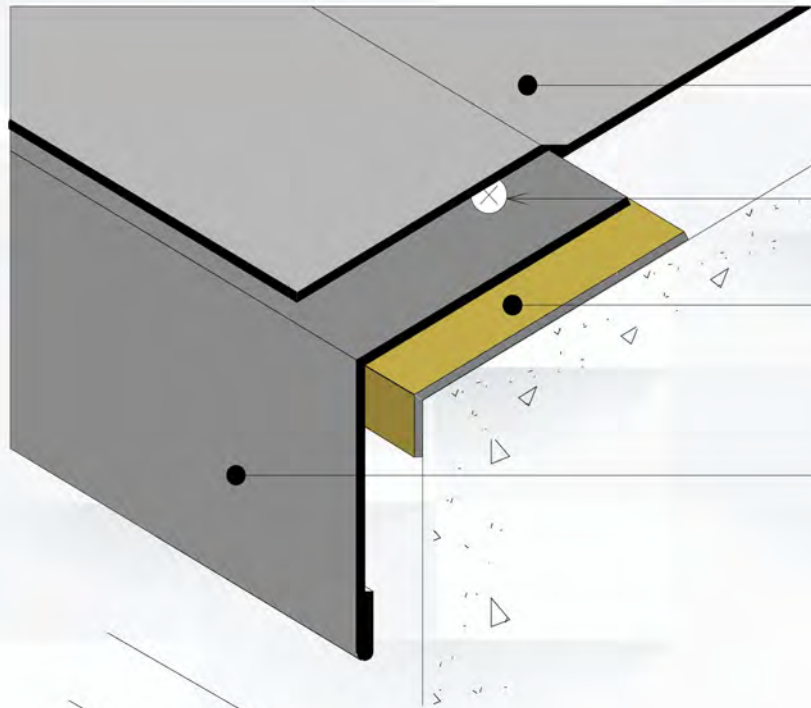

WOLFIN MEMBRANE
AS SPECIFIED

MECHANICAL FIXINGS
@ 150 CENTRES

BUTYL TAPE
SEPARATION/SEALING
LAYER

WOLFINSTEEL P6
FREE EDGE ANGLE

WOLFINSTEEL P6
CAPPING OR SELF-FLASHING EDGE DETAIL

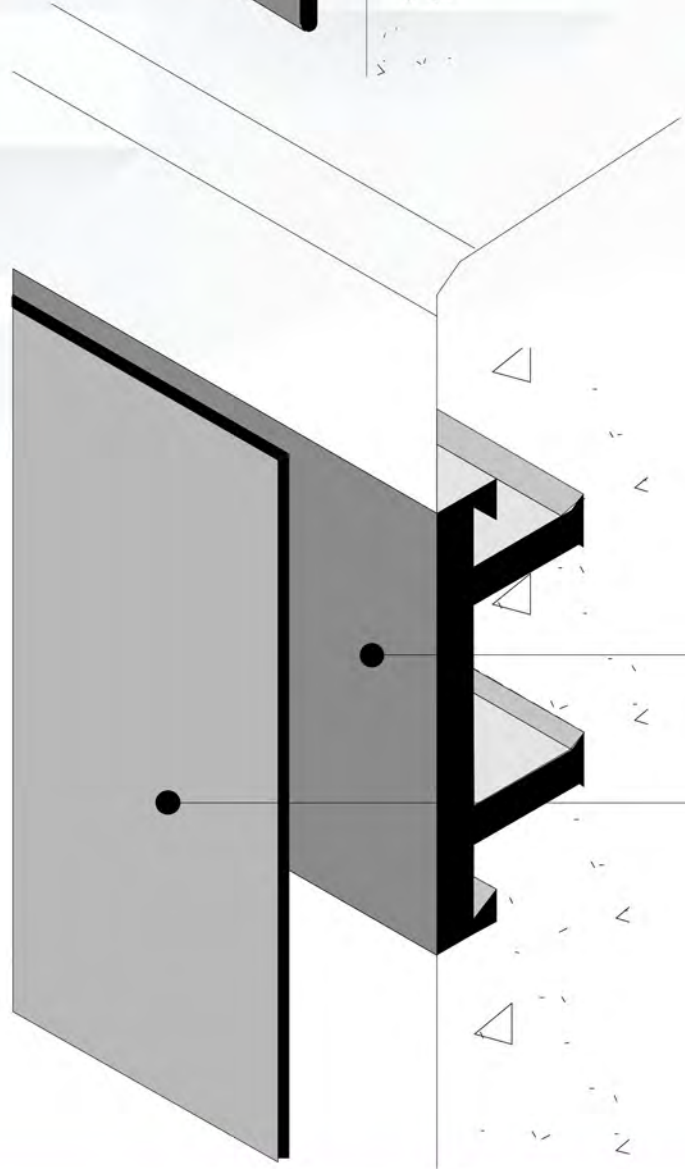

WOLFIN AF6
REGLET

WOLFIN MEMBRANE
AS SPECIFIED

WOLFIN GWSK with Protect Equipment is a high-polymer, entirely homogeneous (no different top, middle and under layer) synthetic roofing and waterproofing membrane with integrated special glass fleece and self-adhesive layer. The membrane is made by extrusion method.

WOLFIN GWSK with Protect Equipment is certified, approved and classified according to:

- | | |
|--|--|
| <ul style="list-style-type: none"> • EN 13956 CE- Waterproofing of Roofs • EN 13967 CE- Waterproofing of Buildings • DIN V 20000-201 (Waterproofing of Roofs) • DIN V 20000-202 (Waterproofing of Buildings) • DIN 18531 (Waterproofing of Roofs) • DIN 18195 (Waterproofing of Buildings) | <ul style="list-style-type: none"> • EN 13501-1 (Class E) • DIN 4102-1 (B2) • DIN ENV 1187 / EN 13501-5 B_{ROOF} (t1) • DIN 4102-7 (External fire) • UEATc guidelines |
|--|--|

Designation according to DIN V 20000-201: **DE/E1 PVC-P-BV- E-(GV)-1,5 (-2,0) -SK**

Designation according to DIN V 20000-202: **BA PVC-P-BV- E-(GV)-1,5 (-2,0) -SK**

Characteristics of WOLFIN GWSK:

- | | |
|---|--|
| <ul style="list-style-type: none"> • Content of high polymer substances more than 94% • Reinforced with integrated special glass fleece • Factory-finished equipped with self-adhesive layer • More than 50 years long-term and practical experiences with WOLFIN membranes • More than 30 years long-term and practical experiences with adhesive • More than 20 years long-term and practical experiences with WOLFIN membranes and adhesive layer • Permeable to water vapour diffusion • My-value ≤ 25.000 (+/- 7.500) incl. self-adhesive layer • Dry-out process of moisturized roof structures is proven by the Fraunhofer Institut Holzkirchen • Free of toxic heavy metals | <ul style="list-style-type: none"> • Fulfils DIN 4102, T 7 (Flying sparks and radiant heat) directly on EPS insulation material at all roof slopes • Free of flame retardants • Lifelong suited for hot-air and solvent welding • Unique chemical resistance: <ul style="list-style-type: none"> • Resistant to bitumen, flux oils, mineral oils, fatty acid, kerosene • Proof of the resistance to sulfurous acid and lactic acid (85%) • Further resistance according to WHG (German water resources act) media group 3 • Chemical resistance to all insulation material • Resistant to plant roots and rhizome according to FLL-test method • Limitation of the ingress of water by the factory made self-adhesive layer |
|---|--|

Types and application areas:

WOLFIN GWSK:	with special glass fleece reinforcement and self-adhesive layer
Membrane width:	1.100 mm / 1.620 mm
Nominal thickness:	2,3 mm (2,8 mm on request)
New building and refurbishment	Bonded layer build-up
Colour:	Black / grey

Systemparts and accessories:

- | | |
|--|--|
| <ul style="list-style-type: none"> • Internal and External Corners • Homogeneous material (WOLFIN IB) • Coated Metal Sheets (Plates/Coils) • Special profile systems | <ul style="list-style-type: none"> • Lightning protection and fastening elements • Stainless steel drainage and ventilation elements • System adhesives |
|--|--|

This Technical data sheet was produced according to the latest technical knowledge and standards of Wolfin Bautechnik. Technical changes due to further developments are possible.

Product information according EN 13956 and EN 13967

EN 13956

Exposed application (bonded)
Under ballast (Gravel, green roof,...)

EN 13967

Damp roof sheets
Basement tanking sheets

Characteristic	Test standard	Unity	Details	Result* 2,3 mm	Result* 2,8 mm
Visible defects	EN 1850-2	-	passed	passed	
Length	EN 1848-2	m	MDV	15 / 10	10 / 10
Width		m	MDV	1,1/1,62	
Straightness		mm	MLV	≤ 50	
Flatness		mm	MLV	≤ 10	
Mass per unit area	EN 1849-2	kg/m ²	MDV	2,7	3,3
Effective thickness		mm	MDV	1,5	2,0
Water tightness	EN 1928 B	kPa	MLV	passed	
External fire performance	ENV 1187	-	Annex E	B _{ROOF} (t1), B _{ROOF} (t4)	
Reaction to fire	EN 13501-1	-	s. 5.2.5.2	Class E	
Joint peel resistance	EN 12316-2	N/50 mm	MLV	NPD	
Joint shear resistance	EN 12317-2	N/50 mm	MLV	≥ 600	
Tensile strength	EN 12311-2	N/50 mm	MLV	≥ 10	
Elongation		%	MLV	≥ 200	
Resistance to impact	EN 12691	mm	MLV	600	750
Method B		mm	MLV	600	750
Resistance to static load	EN 12730 Method B	kg	MLV	≥ 20	
Durability of water tightness against aging	EN 1296 EN 1928	-	passed	passed	
Durability of water tightness against chemicals	EN 1847 EN 1928	-	passed	passed	
Resistance to nail tear	EN 12310-1	N	MLV	≥ 350	
Tear resistance	EN 12310-2	N	MLV	≥ 150	
Resistance to foot penetration	EN 13948	-	passed	passed	
Dimensional stability	EN 1107-2	%	MLV	≤ 0,5	
Foldability at low temperature	EN 495-5	°C	MLV	≤ -20	
UV exposure	EN 1297	visuell	passed	passed	
Hail resistance	EN 13583	m/s	MLV	≥ 25	
Water vapour permeability	EN 1931	-	μ = MDV or 15.000	25.000 ± 7500	
Bitumen compatibility	EN 1548	-	passed	passed	

Explanation: MDV = Manufacturer's declared value
MLV = Manufacturer's limiting value
NPD = no performance determined
* Values in new conditions



1213-CPR-012
EN 13956



1213-CPR-015
EN 13967

*This Technical data sheet was produced according to the latest technical knowledge and standards of Wolfin Bautechnik.
Technical changes due to further developments are possible.*



PROJEX GROUP PTY LTD
ACN 003 859 916
PO Box 98 Matraville NSW 2036
PH: (02) 8336 1666 FX: (02) 9661 9925
e-mail: mail@projex.com.au website: www.projex.com.au

Technical Information

WOLFIN® IB

WOLFIN IB is a single ply, high-polymer, entirely homogeneous synthetic roofing and waterproofing membrane (no different top, middle and under layer). The membrane is produced by extrusion method.

WOLIN IB is certified, approved and classified according to:

- | | |
|--|--|
| <ul style="list-style-type: none"> • EN 13956 CE-Waterproofing of Roofs • EN 13967 CE-Waterproofing of Buildings • DIN V 20000-201 (Waterproofing of Roofs) • DIN V 20000-202 (Waterproofing of Buildings) | <ul style="list-style-type: none"> • DIN 18531 (Waterproofing of Roofs) • DIN 18195 (Waterproofing of Buildings) • EN 13 501-1 (Class E) • DIN 4102-1 (B2) • EN 13948 / FLL |
|--|--|

Designation according to DIN V 20000-201: **DE/E1 PVC-P-BV-1,5 (2,0)**

Designation according to DIN V 20000-202: **BA PVC-P-BV-1,5 (2,0)**

Characteristics of WOLFIN IB:

- | | |
|---|--|
| <ul style="list-style-type: none"> • content of high polymer substances more than 94% • more than 50 years long-term and practical experiences • permeable to water vapour diffusion • My-value ≤ 10.000 (+/- 3.000) • Dry-out process of moisturized roof structures is proven by the Fraunhofer Institut Holzkirchen • free of toxic heavy metals • free of flameproofing agents • ozon- and UV-resitant • lifelong suited for hot-air and solvent welding | <ul style="list-style-type: none"> • unique chemical resistance: • resistant to bitumen, flux oils, mineral oils, fatty acid, kerosene • European Technical Approval (ETA-10/0295) as sealant in collecting basins and chambers in storage plants of water polluting substances • Proof of the resistance to sulfurous acid and lactic acid (85%) • Chemical resistance to all insulation material • resistant to plant roots and rhizome according to FLL-test method |
|---|--|

Types and application areas:

WOLFIN IB:	Single-ply, homogenous membrane
Membrane width:	1.100 mm / 1.620 mm
Nominal thickness:	1,5 mm / 2,0 mm
New building and refurbishment	<ol style="list-style-type: none"> 1) loose laid under ballast 2) WOLFIN / PYE-composite systems 3) Special application: Waterproofing under mastic asphalt, sealant in collecting basins and chambers in storage pants of water polluting substances (ETA-10/0295)
Colour:	black, grey

Systemparts and accessories:

- | | |
|--|---|
| <ul style="list-style-type: none"> • Internal and External Corners • Composite Metal Sheets (Plates / Coils) • Special profile systems • Lightning protection elements | <ul style="list-style-type: none"> • Stainless steel drainage and ventilation elements • Stainless steel overflows etc. • System adhesives |
|--|---|

This Technical data sheet was produced according to the latest technical knowledge and standards of Wolfin Bautechnik. Technical changes due to further developments are possible.

PROJEX
GROUP OF COMPANIES

PROJEX GROUP PTY LTD

ACN 003 899 916

PO Box 98 Matraville NSW 2036

Ph: (02) 8336 1666 FX: (02) 9661 9925

e-mail: mail@projex.com.au website: www.projex.com.au

Produkt information according EN 13956 and EN 13967

EN 13956

Under ballast (gravel, green roof, ...)

EN 13967

Damp proof sheets
Basement tanking sheet

Characteristic	Test standard	Unity	Details	Result* 1,5 mm	Result* 2.0 mm
Visible defects	EN 1850-2	-	passed		passed
Length	EN 1848-2	m	MDV	15	10
Width		m	MDV		1,1/1,62
Straightness		mm	MLV		≤ 50
Flatness		mm	MLV		≤ 10
Mass per unit area	EN 1849-2	kg/m ²	MDV	1,9	2,5
Effective thickness		mm	MDV	1,5	2,0
Water tightness	EN 1928 B	kPa	MLV		≥ 400
Reaction to fire	EN 13501-1	-	s. 5.2.5.2		Class E
Joint peel resistance	EN 12316-2	N/50 mm	MLV		≥ 150
Joint shear resistance	EN 12317-2	N/50 mm	MLV		≥ 600
Tensile strength	EN 12311-2	N/50 mm	MLV		≥ 16
Elongation		%	MLV		≥ 300
Resistance to impact	EN 12691	mm	MLV	≥ 600	≥ 750
Method A					
Method B	EN 12691	mm	MLV	≥ 600	≥ 750
Resistance to static load	EN 12730 Method B	kg	MLV		≥ 20
Durability of water tightness against aging (72d / 400kPa)	EN 1296 EN 1928	-	passed		passed
Durability of water tightness against chemicals	EN 1847 EN 1928	-	passed		passed
Resistance to nail tear	EN 12310-1	N	MLV		≥ 250
Tear resistance	EN 12310-2	N	MLV		≥ 100
Resistance to root penetration	EN 13948	-	passed		passed
Dimensional stability	EN 1107-2	%	MLV		≤ 1,5
Foldability at low temperatures	EN 495-5	°C	MLV		≤ -25
UV exposure	EN 1297	visuell	passed		passed
Hail resistance	EN 13583	m/s	MLV		≥ 25
Water vapour permeability	EN 1931	-	μ = MDV or 15.000		10.000 ± 3.000
Bitumen compatibility (90d / 70°C)	EN 1548	-	passed		passed

Explanation: MDV = Manufacturer's declared value
MLV = Manufacturer's limiting value
* Values in new conditions



1213-CPR-012
EN 13956



1213-CPR-015
EN 13967

This Technical data sheet was produced according to the latest technical knowledge and standards of Wolfin Bautechnik. Technical changes due to further developments are possible.



PROJEX GROUP PTY LTD
ACN 003 859 916

PO Box 98 Matraville NSW 2036
PH: (02) 8336 1666 FX: (02) 9661 9925
e-mail: mail@projex.com.au website: www.projex.com.au

WOLFIN WARRANTY

All Wolfin membrane installations are guaranteed by a single point warranty on both materials and workmanship. Warranties are issued in favour of the building/structure owner.



The Wolfin System has been used at Taronga Zoo for different exhibits including The Ocean Precinct and the gorilla, elephant and lemur enclosures.

www.projex.com.au



(02) 8336 1666



mail@projex.com.au