

HELLA

OUTDOOR BLINDS + EXTERIOR VENETIAN BLINDS

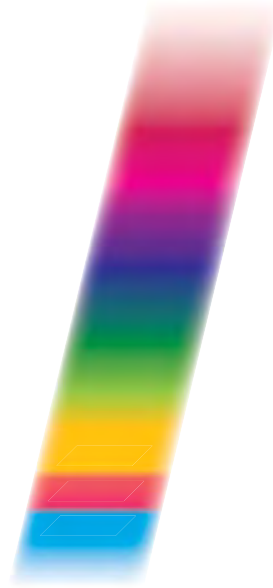



THE FACETS OF LIGHT

Opposites attract. The night accompanies the day.
Light needs darkness. Black requires white. Where there is light
there is also shade – the gentle form of light.

Softened brightness. Diffused rays. They are gently painting the
room. With stripes, dots, fine lines and manifold figures.

They are flashing over the walls, dancing on the floors, creating
ambience. A shadow theatre being as beautiful and versatile as
the sun protection systems by HELLA.



INDIVIDUAL –
LIGHT AND
SHADE

OUTDOOR BLINDS + VENETIAN BLINDS

Technical and optical highlight of the HELLA product portfolio: As a flexible and highly effective sun and sight screen solution, outdoor blinds and Venetian blinds ensure optimum indoor climate and comfort.

Due to their unique design they are fascinating elements for facade decoration, with which the insolation can be regulated individually.

If you want to enjoy an ultimate comfy atmosphere, outdoor blinds and Venetian blinds are your first choice.



ECN-SYSTEM®: THE INNOVATION!



The unique connection of the individual slats with a patented stainless steel clip cam belt (ENC) sets completely new standards for outdoor blinds.

HELLA is well known for its unique slat programme. The ECN-System® completes the design and improves the functionality of the traditional systems.

**The new generation of outdoor blinds:
Improved values compared to traditional systems:**

- Uniquely precise packaging thanks to the ECN-System®
- Smaller and narrower packages
- Smaller top board heights
- Higher wind stability and durability

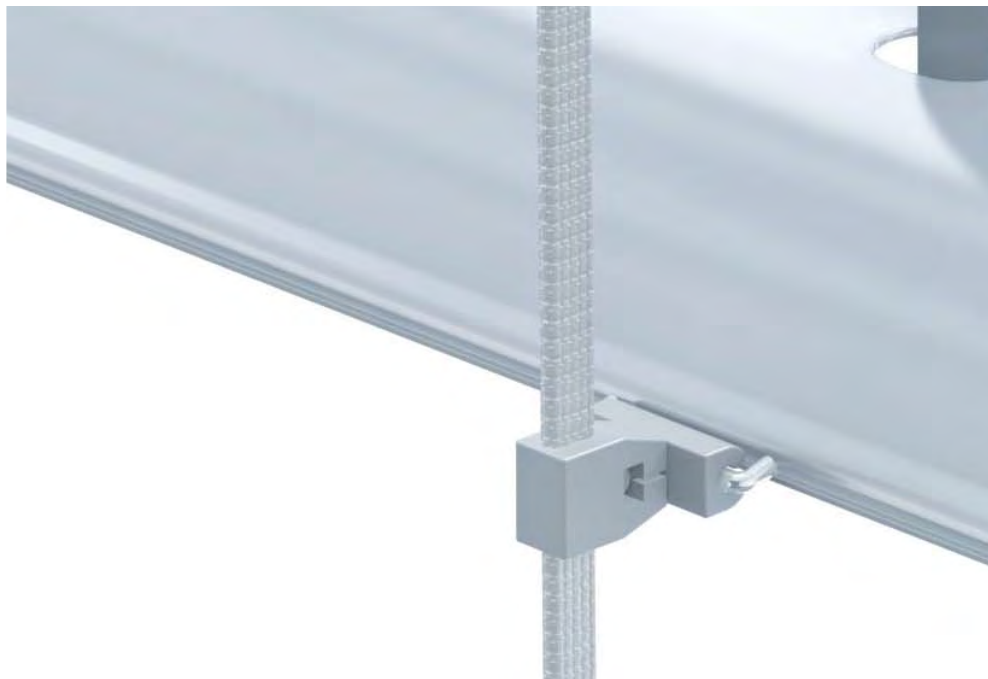



SMALL PART, GREAT EFFECT

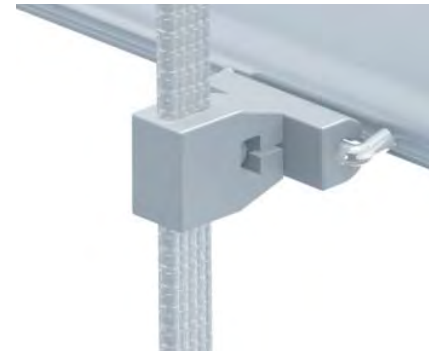

Due to Kevlar insertions, the textile carrying strip is extremely shape-retaining and thus can guide the slats silently, safely and free of torsion by means of two-part connecting pins made of plastic and stainless steel brackets.

This has a direct effect on the durability of the product and on the basic components like lifting tapes, guide rail insert and guide pins.



precise packaging



high wind stability





THE ORIGINAL FOR EVERY SITUATION

HELLA developed S-shaped slats for outdoor blinds and has thus created blackout blinds for every form line.

As it has been functionally evolved and perfected with the ECN-System® the latest generation of outdoor blinds can be technically installed even if you have only little space available.

This package, clearly defined in height and width, is perfectly suitable for an area to be rehabilitated and enables the optimum use of existing recesses.

Improved values compared to traditional systems:

- Installation is possible in recesses of 110 mm, you are saving approx. 30 mm
- Excellent blacking out
- Unique, since it is available with wire tensioning

OUTDOOR BLINDS AR 63 S ECN



The original S-shaped slat, only available from HELLA:
soft and elegant wave contour

OUTDOOR BLINDS AR 63 Z ECN



The Z-shaped slat:
modern-geometric shape

Slat width	63	Slat type	bordered
Side guidance	Cable / guide rail	Max. height (mm)	5200 (K/M)
Min. slat width (mm)	420 (K) / 430 (M)	Max. slat width (mm) single unit	5000 (K/M)
Max. blind surface (m²) single unit	14 (K) / 20 (M)	Max. blind surface (m²) linked units	12.6 (K) / 22.5 (M)



with guide rail, closed



with wire tensioning, opened by 45°



Thanks to the integrated sealing strip, both slat profiles convince with a quiet closing process.



HIGHLIGHT IN FULL WIDTH

The outdoor blind AR 92 is the technical and visual highlight with wind resistant blind slats.

It is a real "all-rounder" and ensures optimum indoor climate: Heat protection due to reflection of the sunlight in front of the facade. Control of the incoming light and excellent blacking out via adjustable slats, protection against bad weather due to the possibility to close the slat system completely.

And to avoid annoying noise, the slats are guided in guide rails that are provided with plastic inserts. The slat design is unique: the broad design and the variety of colours make the AR 92 an attractive design element for the facade.





OUTDOOR BLINDS AR 92 S ECN



The original S-shaped slat, only available from HELLA: soft and harmonious line management

OUTDOOR BLINDS AR 92 Z ECN



The Z-shaped slat:
geometrically distinct contour

Slat width	92	Slat type	bordered
Side guidance	Cable / guide rail	Max. height (mm)	5200 (K/M)
Min. slat width (mm)	480 (K) / 500 (M)	Max. slat width (mm) single unit	5200 (K/M)
Max. blind surface (m²) single unit	11.5 (K) / 11.5 (M)	Max. blind surface (m²) linked units	12.6 (K) / 22.5 (M)



with guide rail, closed



with wire tensioning, opened by 45°



Thanks to the integrated sealing strip, both slat profiles convince with a quiet closing process.

REINVENTED PERFECTION

The classic outdoor blind AR 80 was refined in many details by HELLA technicians and now the AR 80 ECN embodies the new generation of multifunctional outdoor blinds. The integrated ECN-System and a unique slat package provide more wind stability and extraordinary efficiency of the light control function for this product.

Another invention by HELLA.





OUTDOOR BLINDS AR 80 ECN



Slat width	80	Slat type	bordered
Side guidance	Cable / guide rail	Max. height (mm)	5200 (K/M)
Min. slat width (mm)	400 (K) / 430 (M)	Max. slat width (mm) single unit	5000 (K/M)
Max. blind surface (m²) single unit	14 (K) / 20 (M)	Max. blind surface (m²) linked units	12.6 (K) / 22.5 (M)

HELLA has already revolutionised the market for outdoor blinds with its invention of the S-shaped slat. Now, together with the innovative ECN-System, the new convex-concave slat AR 80 is following. Also available with light control function, if requested.



Optimised closing process thanks to the ECN-System®



Unique precise packaging





THE CLASSIC IN PROVEN DESIGN

The outdoor blind model ARO 65 is among the proven classics on the market.

The slats are - like all HELLA outdoor blinds - made of a highly elastic special aluminium alloy and convex-concave roll formed. Bordered hollow punchings protect the lifting tapes and supersede plastic clips. The bottom rail made of extruded aluminium profile is guided in the rails by plastic pins on both sides, which makes the entire slat blind more stable. All slat guide pins are made of zinc. Consequently this classic is an almost maintenance-free facade element.

If desired, the outdoor blind ARO 65 is also available with light control function.



OUTDOOR BLIND ARO 65



Slat width	65	Slat type	bordered
Side guidance	Cable / guide rail	Max. height (mm)	5200 (K/M)
Min. slat width (mm)	400 (K) / 430 (M)	Max. slat width (mm) single unit	5000 (K/M)
Max. blind surface (m²) single unit	14 (K) / 20 (M)	Max. blind surface (m²) linked units	12.6 (K) / 22.5 (M)



with guide rail, closed



with guide rail, opened to 90°



HELLA replaces the traditional conductive band fixation with plastic grommets by a fixation via smart OMEGA punching. This creates a unique product without plastic grommets. Perfect design and almost maintenance-free!





DELICATE AND CLEVER

A cloudless hot summer day. But a few dark thunder clouds, and shortly after the rain beats through the streets. But you would love nothing better than to ignore this. So it is better to lower the exterior Venetian blind and leave the weather outside. That way you immediately feel more safe and secure. And you create your own individual climate of well-being.

And the technical characteristic:

Sometimes the architecture asks for delicate lines. The answer are flexible slats. The slats of the Venetian blinds convince by their high flexibility, so that they evenly withstand high wind loads and always retake their original form.

EXTERIOR VENETIAN BLINDS AF 50 / AF 60 / AF 80 / AF 100

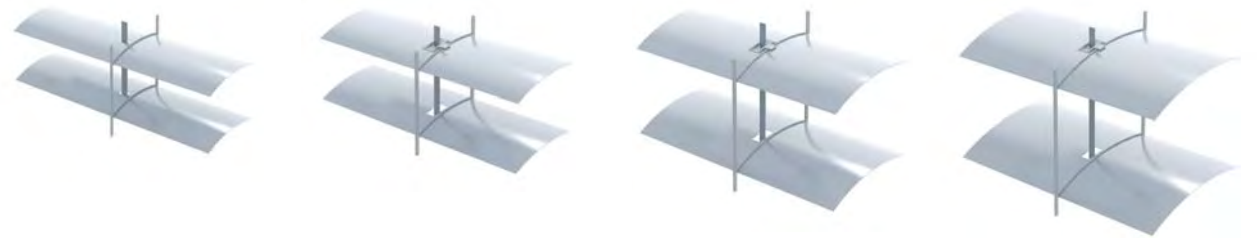

Slat width	50 / 60 / 80 / 100	Slat type	flat
Side guidance	Cable / guide rail	Max. height (mm)	5200 (K/M)
Min. slat width (mm)	465 (K) / 490 (M)	Max. slat width (mm) single unit	5000 (K/M)
Max. blind surface (m²) single unit	14 (K) / 20 (M)	Max. blind surface (m²) linked units	12.6 (K) / 22.5 (M)
Max. blind surface (m²) AF 50	20 (K) / 20 (M)	Max. blind surface (m²) AF 50	18 (K) / 32.5 (M)



with wire tensioning,
closed



with wire tensioning,
opened by 45°



with wire tensioning,
opened by 90°

AF 50 E: E stands for "Economy"! The especially well-priced alternative to an exterior Venetian blind, particularly suitable for smaller dimensions (different limiting sizes).

AF 50: only with cable guiding

AF 100: max. height 4000 mm

DECORATIVE DESIGN – HARMONIOUS ATMOSPHERE

With interior Venetian blinds it is possible to control the daylight completely individually: This creates a pleasant atmosphere within your home. Different types of slats and the broad variety of colours can be used specifically to create a pleasant atmosphere. And your privacy is protected effectively against prying eyes.

Due to its universal usability in all living and working areas, the interior Venetian blind is still a real classic.





INTERIOR VENETIAN BLINDS IF 50 / IF 60 / IF 80



Slat width	50 / 60 / 80	Slat type	flat
Side guidance	without / cable	Max. height (mm)	5200 (K/M)
Min. slat width (mm)	460 (K) / 490 (M)	Max. slat width (mm) single unit	5000 (K/M)
Max. blind surface (m²) single unit	14 (K) / 20 (M)	Max. blind surface (m²) linked units	12.6 (K) / 22.5 (M)
Max. blind surface (m²) IF 50	20 (K) / 20 (M)	Max. blind surface (m²) IF 50	18.9 (K) / 32.4 (M)



closed



opened by 45°



opened by 90°

SUSTAINABLE ENERGY AND ENVIRONMENTAL EFFICIENCY

Prevailing outside temperatures find their ways into all buildings. As long as these temperatures are agreeable, we feel comfortable indeed. Heat or the cold, however, need to be locked out. This requires cooling or heating energy. However, thanks to modern building and home technology this energy requirement can be reduced significantly – and hence costs can be lowered.

HELLA sun and weather protection products reduce the energy requirement to create a comforting atmosphere by up to 50 %!

There is a pleasant side effect: They are thereby protecting our nature.





COOLING AND HEATING

Summer

HELLA outdoor blinds and Venetian blinds can reduce the effects of high outside temperatures by up to ca. 95 %, depending on the continuously variable use. You can even set aside an air-condition and still maintain a comfortable cool temperature.

Winter

When closed, HELLA outdoor blinds/Venetian blinds create a standing air cushion in front of the glass and thus prevent circulation of air. Energy consumption for heating can be lowered by up to 30 %, depending on the product.

LESS COOLING ENERGY IN THE SUMMER

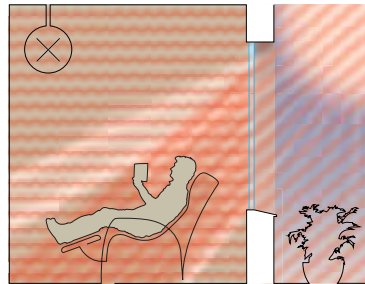

Heat can enter the living space without hindrance. The temperature inside the room is unpleasantly high.

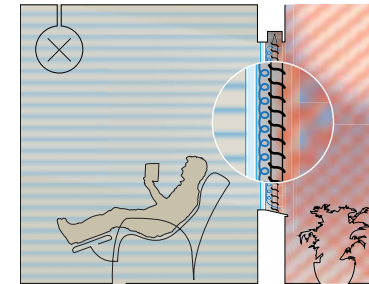

The air circulation between outdoor blinds/Venetian blinds and windows largely eliminates heat transfer via convection.

LESS HEATING ENERGY DURING WINTERTIME

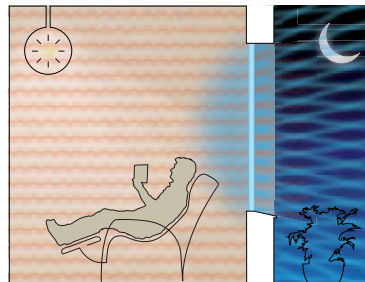

In cold temperatures windows and glass facades function like a thermal bridge: The warm air escapes and it becomes unpleasantly chilly in the living area.

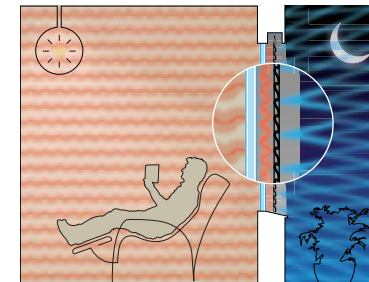

When the outdoor blinds/Venetian blinds are closed, an air cushion is created in front of the glass, which prevents circulation of air. As a result, the warm air stays inside the living area and keeps the cold air outside.





HELLA WORKING POSITION

Standard

down up



Working position

down up

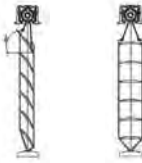

The working position enables you to open and close the outdoor blinds/
Venetian blinds without having to forego entry of light. When you lower the
blinds, the slats are inclined by 50° and when you raise them by 90°. For
this reason the light can flow through the room even during this phase.

HELLA PERFORATION



Perforated slats enable a regula-
ted entry of light, even when they
are in a closed or semi-closed
position. If you desire, you can
choose a perforation on the up-
per or lower part of the blind or
on the entire blind. And the great
thing is: You can enjoy the "vista"
to the outside!

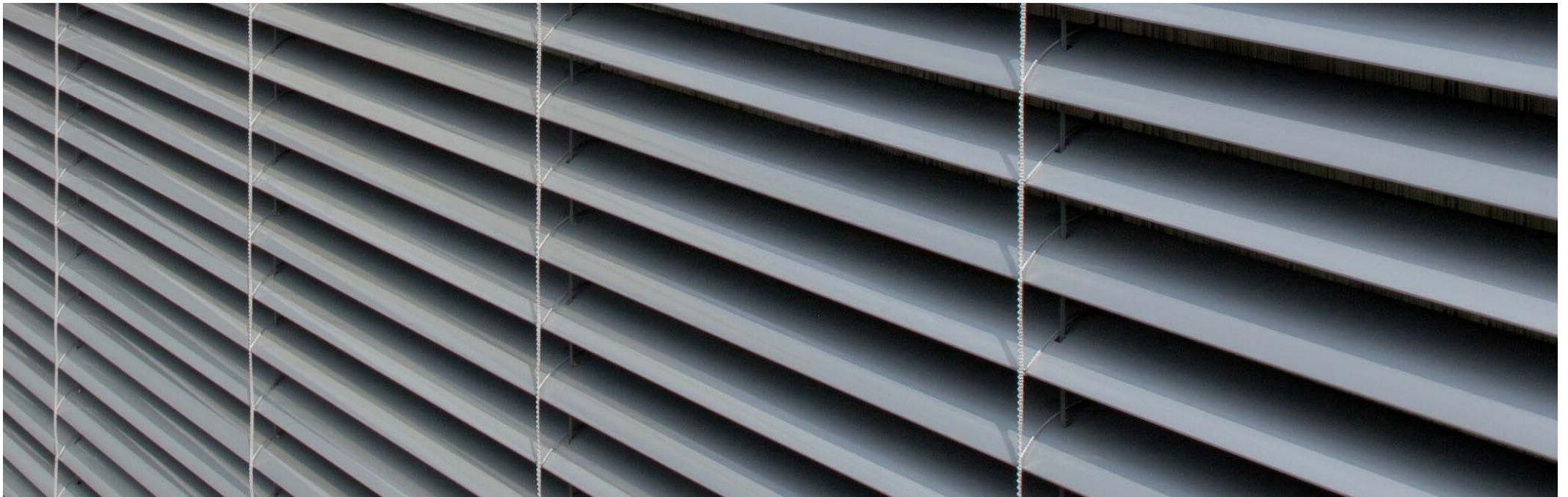



HELLA LIGHT CONTROL FUNCTION

Full light when you need it, continuous blacking out as you desire: Owing to the individual light control function, HELLA outdoor blinds and Venetian blinds create a harmonious room ambience. The light control function also reduces lighting costs for your rooms.

Individually controllable slat positions enable you to use the daylight to the best advantage - absolutely glare-free.

Available for all models, except for AF 50 E.

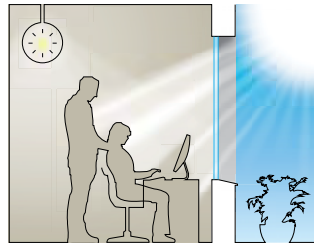

Without outdoor blinds/Venetian blinds the sun glares and you need artificial light to illuminate the room when curtains or roller shutters are closed.

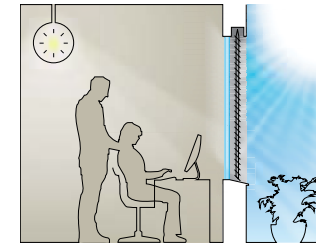

Standard outside blinds/Venetian blinds without light control function provide view and glare control, however, you need artificial light again to illuminate the room.

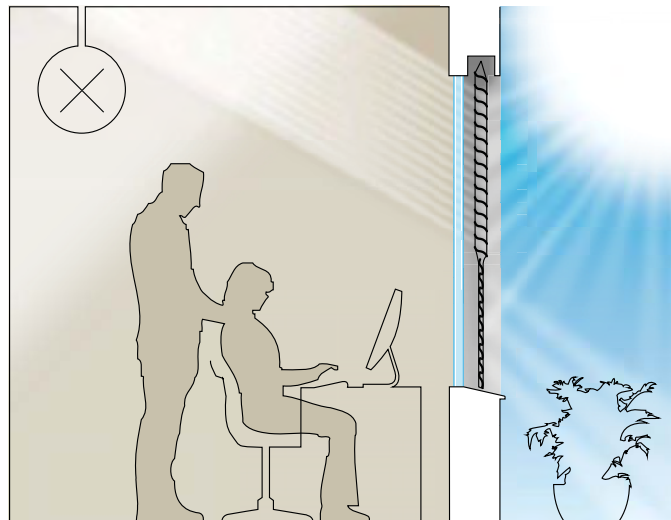
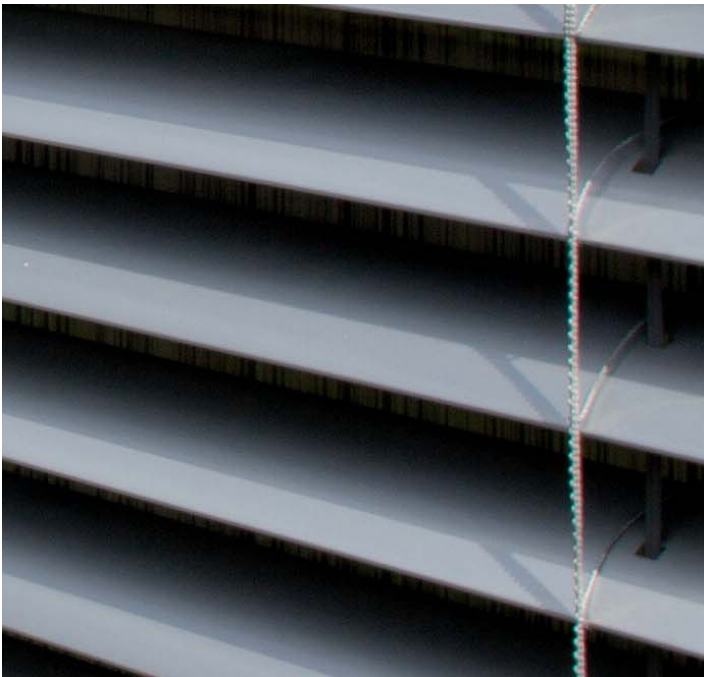

The HELLA light control function does not only provide view and glare protection but also perfectly uses the daylight to light up the room.
No artificial light = comforting atmosphere and energy savings at the same time!



with light control function

COMFORT AT WILL

We attach great importance to flexibility:
All HELLA products are available in individual
designs to meet your requirements.

They can be controlled, operated and installed
in different ways.

This is how you obtain the product which fits your individual needs.

TYPES OF OPERATION

HELLA outdoor blinds and
Venetian blinds can be raised or
lowered at the flick of your wrist.
Both the easy to use crank hand-
le operation and the motor drive
(optional with remote control)
ensure precise fine adjustment.

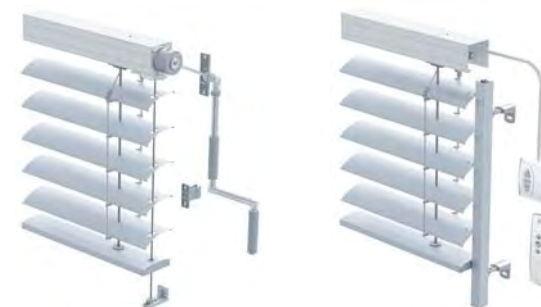



INTELLECT MEETS INNOVATION



HELLA automation allows you to control outdoor blinds/Venetian blinds comfortably and modernly via a panel or your smart phone. Diverse presets, the combination with further devices, as well as an automated control of the slats depending on season and orientation of the facade are possible. The perfect solution for large facades and high user requirements.

INSTALLATION DETAILS

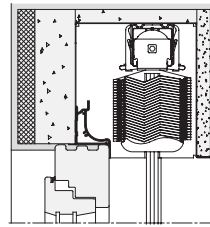

Outdoor blinds/Venetian blinds in the tray

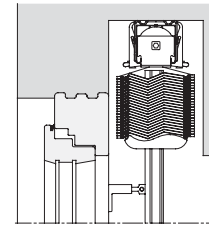

Installation in recess

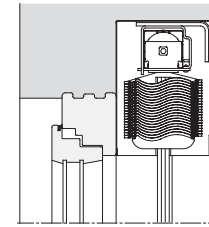

canted plaster base box

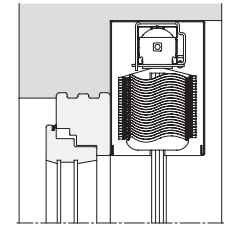

canted U-channel

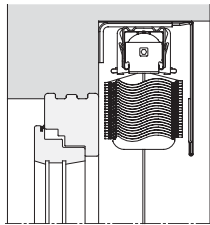

canted angular top board in the recess

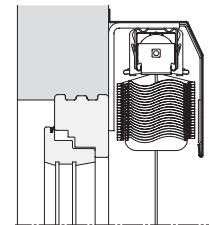

canted angular top board

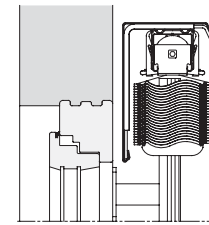

canted U-channel with chamfer placed on guide rail

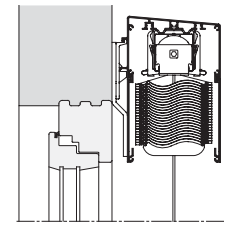

extruded facade box with wire tensioning

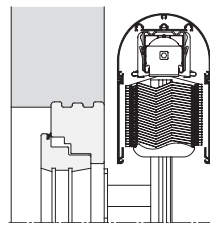

extruded semi-circular arch channel placed on guide rail

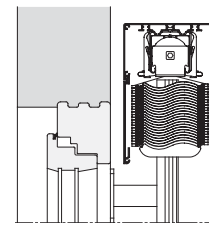

extruded U-channel placed on guide rail

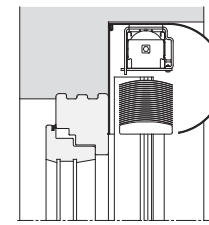

Outdoor blinds/Venetian blinds in a round roller shutter box

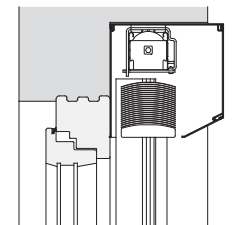

Outdoor blinds/Venetian blinds in a square roller shutter box







BLITZRAFFER® EMERGENCY BLIND SYSTEM

BLITZRAFFER® is the innovative emergency blind system by HELLA. The new HELLA system meets the legal standard, which requires to clear an escape path within 3 seconds. From now on we can guarantee holistic facade blind appearance without disturbing compromises for escape doors.



GUIDE RAILS FOR OUTDOOR BLINDS / VENETIAN BLINDS



round
Dim. Ø 45 mm



square
Dim. 22 x 27 mm
Dim. 37 x 27 mm



for box systems
Dim. 30 x 32 mm
Dim. 37 x 32 mm



Combined guide rail for surface/flush mounted installation
Dim. 28 x 85 mm



for lateral installation on the brickwork or in the groove already provided during the carcassing
Dim. 22 x 22 mm



BORDERED HOLLOW PUNCHINGS



The bordered hollow punchings of outdoor blinds are already standard in HELLA products, however, they are still unique on the market. They protect the lifting tapes, avoid sharp edges and therefore provide a higher level of protection. A smooth run is guaranteed.

WIND RESISTANT DESIGN



The wind resistant design allows the use in wind speeds of up to 80 km/h. In addition to the guide rails, the slats are guided by at least 2 polyamide-sheathed high-grade steel wires. The tension brackets for the 2 outer wind protection devices are mounted directly on the guide rail.

THE COLOURFUL WORLD OF HELLA

Colours express style and emotions at the same time. The colour of the slats harmoniously emphasises the architectural design of buildings or consciously create design contrasts. Depending on the chosen colour of the slats, the inciding sunlight creates emotionally clearly defined feelings when it is redirected into the living or working area.

Now you can control your personal comforting atmosphere!



RAL 9010 pure white



RAL 7035 light grey



RAL 9007 grey aluminium *

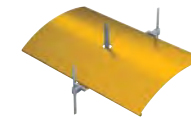

RAL 1007 daffodil yellow



RAL 6005 moss green

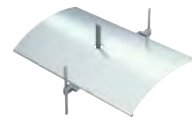

RAL 9016 white *

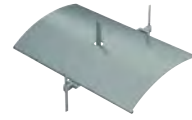

RAL 7038 agate grey

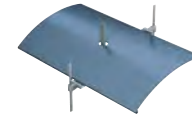

RAL 5014 pigeon blue

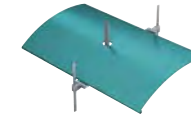

RAL 5018 turquoise blue



RAL 8014 sepia brown

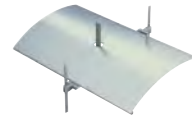

RAL 9002 grey white



RAL 9006 white-aluminium *

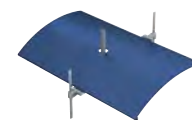

RAL 5002 ultramarine blue

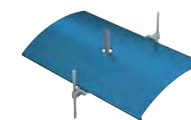

RAL 5009 azure blue



RAL 7016 anthracite-grey *

* Standard with AF 60/100 or IF 60



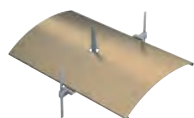

Colour-No. 0240 light beige

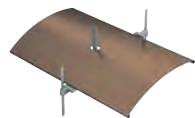

Colour-No. 0110 dark beige

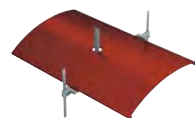

Colour-No. 0120 terracotta

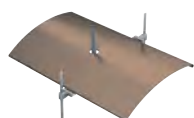

Colour-No. 0003 beige



Colour-No. 0780 bronze



Colour-No. 0330 purple red

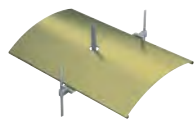

Colour-No. 0909 yellow beige



Colour-No. 703 iron mica



OUTDOOR BLINDS AR 63 ECN / AR 92 ECN / ARO 65 / AR 80 ECN

Package height (mm)	1000	1500	2000	2500	3000	3500	4000	4500	5000	Depth of the rec
AR 63 S+Z ECN	160	195	225	260	295	330	360	390	425	min. 110
AR 92 S+Z ECN	150	180	205	230	260	290	320	345	370	min. 140
ARO 65	160	190	220	255	285	320	350	380	405	min. 110
AR 80 ECN	150	170	195	220	245	270	295	320	345	min. 125

EXTERIOR VENETIAN BLINDS AF 50 / AF 60 / AF 80 / AF 100

Package height (mm)	1000	1500	2000	2500	3000	3500	4000	4500	5000	Depth of the rec
AF 50 E	95	110	120	135	150	–	–	–	–	min. 76
AF 50	125	140	155	170	180	195	210	225	235	min. 90
AF 60	135	155	175	195	210	230	250	270	290	min. 100
AF 80	125	130	145	155	165	175	190	200	210	min. 120
AF 100	120	130	145	155	165	175	190	–	–	min. 140

INTERIOR VENETIAN BLINDS IF 50 / IF 60 / IF 80

Package height (mm)	1000	1500	2000	2500	3000	3500	4000	4500	5000
IF 50	125	140	155	170	180	195	210	225	235
IF 60	135	155	175	195	210	230	250	270	290
IF 80	125	130	145	155	165	175	190	200	210

Standard slat colours: available for all outdoor blinds and Venetian blinds, excluding AF 50, IF 50, AF 60, IF 60 and AF 100. AF 50, IF 50 Please order our special colour chart for AF 50, AF 60, IF 60 and AF 100: Standard colours are RAL 7016, RAL 9006, RAL 9007 and RAL 9016.

Standard colours for all guide rails and bottom rails: RAL 7016, RAL 9006, RAL 9007, RAL 9016 and natural coloured anodized (E6/EV1, A6/C0). Standard colours according to our RAL classic colour chart are available without surcharge, excluding pearl effect, metallic or fluorescent colours. (Printing related differences in colours are reserved)





THAT'S WHY YOU WANT HELLA

The long-established company HELLA is one of the leading European manufacturers of sun and weather protection systems and stands for functional innovations, visionary design and maximum customer benefit.

The world of sun and weather protection is constantly changing due to numerous patented developments. This great added value to the product is highly appreciated by all customers.

HELLA places emphasis on the sustainability of its products, especially on a long lifespan and the reduction of energy consumption at home and at the office. What a pleasure that it even improves the living comfort.

HELLA THE ORIGINAL!

HELLA convinces with innovative strength and a large variety of products – all of top of the line quality and perfect function.

The complete sun and weather protection system by HELLA: Venetian blinds, awnings, outdoor blinds, roller shutters, facade blinds, conservatory blinds, insect and anti-glare blinds, blackout elements, interior blinds, lintel system HELLA trav, box systems, plaster top board systems, custom-made designs and special constructions. Modifications are the instruments for technical progress and remain subject to change.

10 reasons to buy HELLA products:

- Genuine customer proximity due to many specialist shops and selected retail partners
- High-quality expert advice from qualified sales assistants
- Best price-performance ratio
- Professional and on-time installation
- Customer oriented service by trained technicians
- Comprehensive guarantees
- Finest product quality thanks to development and production on our own premises
- Made in Austria & Germany
- Ecologically oriented quality with maximisation of energy savings
- And last but not least: 50 years of tradition

HELLA.INFO