



PERMA-TRENCH

Flo-Thru Trench Drain Systems



General Terms and Conditions of Sale – Drainage

PRICE AND TERMS OF PAYMENT

Terms are net, payable 30 days from date of invoice. All pricing in AUD and subject to GST. LWG Zurn Australia P/L reserves the right to apply a freight charge to all Flo-Thru Drainage orders. All orders are subject to credit approval by the LWG Zurn Accounts Department prior to the acceptance of an order. Orders may be refused, delivery may be withheld, or shipment stopped in transit without any liability on LWG Zurn's part at LWG Zurn's sole discretion based upon Buyer's credit worthiness as determined by LWG Zurn.

FREIGHT

All sales are F.O.B. seller's location. LWG Zurn will apply a freight charge to all Flo-Thru Drainage orders. Shipment is within Australia and must have a single destination of a buyer's standard address or job location. Routing of shipment shall be determined at the sole direction of LWG Zurn P/L. Shipping dates are estimates and time of delivery shall not be of the essence of this sale contract. Under no circumstances will the Seller have any responsibility on account of any delays in manufacture, transportation, or otherwise.

NOTE: LWG Zurn Linear Drainage range shall be defined as an oversized and/or overweight product and LWG Zurn's standard terms do not apply. Please contact our customer service department for guidance on shipping charges.

These charges and restrictions apply in addition to LWG Zurn standard terms and conditions for sale unless otherwise agreed upon by the parties

RETURNED GOODS

Standard catalogued material may be returned only with an R.A (Return Authority) number issued by LWG Zurn. Product must be returned within 60 days. All returns after 60 days are subject to the discretion of the National Sales Manager. Returned goods are subject to a minimum \$50 or 25% (whichever is greater) restocking charge of total saleable material returned. Transportation charges are the responsibility of the Buyer. Credit allowance will be in the form of account credit. No credit will be allowed for parts unless originally ordered and invoiced as parts. No credit will be allowed for discontinued or made-to-order items. Items that have been specially made are not subject to return or cancellation except by special negotiation. No credit is allowed for Linear Drainage products that have been cut.

ILLUSTRATIONS OF TYPICAL INSTALLATIONS

The typical installations for various products found in each product section are intended to illustrate the products and potential options for the use of these products. Under no circumstances are they to be construed as recommended installation procedures. Consult local codes and project specifications for proper installation instructions.

SHORTAGE/DAMAGE CLAIMS

Notification of material shortages or incorrect filling of orders must be made to LWG Zurn within 10 days of receipt. No claims over three months old will be honoured. Buyer agrees to make all complaints for damage in transit or "short count" directly to the carrier; before the contents are unloaded have the carrier agent's acknowledgement of such damage noted on the bill of lading and to present to the carrier its agent's acknowledgement of such damaged material with formal claim covering said damage.

GENERAL

LWG Zurn reserves the right to make changes in design or equipment of any item or product without incurring any obligation on previously sold items, and to discontinue items at any time, without notice. Possession of this Catalogue or other sales literature is not to be construed as an offer to sell. All orders are subject to acceptance by LWG Zurn. Catalogue printed in Australia. For compliances, contact LWG Zurn Australia P/L, Head Office: +61-3-8301-9499

LIMITED WARRANTY

1. LWG Zurn Linear Drainage goods sold hereunder are warranted to be free from defects in material and factory workmanship for the period of one year from the date of purchase.
2. All product must be installed in accordance with manufacturer's instructions.
3. Where permitted by law, THE IMPLIED WARRANTY OF MERCHANTABILITY IS LIMITED TO THE ABOVE IDENTIFIED PERIOD OF TIME AND SHALL BE LIMITED SOLELY TO THE REPLACEMENT OF THE DEFECTIVE GOODS. Please contact LWG Zurn Customer Care for assistance.
4. LWG Zurn will replace goods at no cost that prove defective provided LWG Zurn is notified in writing of such defect and the goods are returned prepaid at the specified LWG Zurn location with evidence that they have been properly maintained and used in accordance with instructions.
5. LWG ZURN SHALL NOT BE RESPONSIBLE FOR ANY LABOR CHARGES OR ANY LOSS, INJURY, OR DAMAGES WHATSOEVER, INCLUDING, BUT NOT LIMITED TO, INCIDENTAL OR CONSEQUENTIAL DAMAGES.
6. The sole and exclusive remedy shall be limited to the replacement of the defective goods.
7. Before installation and use, the purchaser shall determine the suitability of the product for his intended use and the purchaser assumes all risk and liability whatever in the connection therewith.
8. All weights stated in LWG Zurn catalogues and lists are approximate and are not guaranteed.

Flo-Thru Drain Systems



LWG is Australia's leading supplier of specialised plumbing products with a proud half-century history of introducing unique plumbing products to the Australian market. Our recent history has been most exciting with our business becoming a division of the Zurn Industries (Rexnord) group in 2013.

Our early adoption of water and energy conserving plumbing products places LWG in a prime position to meet the changing needs of the industry. Products such as waterless urinals and timed flow tapware have been in our product range for almost a decade, and we continue to develop and expand this area.

LWG Zurn Flo-Thru pre-engineered modular trench drain systems are designed for ease of installation, load-bearing strength, hydraulics, chemical resistance, and structural integrity. Strong and durable for the toughest job applications, LWG Zurn Flo-Thru trench drain systems work well in manufacturing and industrial facilities, parking areas, swimming/sport facilities, tracks and athletic fields, high volume roadside applications, airports, and food processing or pharmaceutical applications. The LWG Zurn Flo-Thru systems offer several advantages over either on-site cast-in-place forming or precast polymer concrete systems.

Savings – Lightweight modular assemblies reduce labor and installation time, eliminate costly leveling/alignment hardware and reduce costly freight charges.

Flow Velocity – Built-in molded slope produces superior flow characteristics. Smooth, non-porous internal surface further enhances flow.

Versatility – Optional accessories and ease of modification offer the most versatile trench drainage systems available to satisfy your project requirements.

Quality – Modular sections are assembled together to produce straight, uniform drainage systems. Options such as Dura-Coated heavy-duty steel frames and grates, mechanical interlocking joints, rebar clips, and combination anchor tabs/leveling devices reduce labor during installation and allow for durable, flexible systems.

Support Materials Available Upon Request

- Technical assistance
- Jobsite installation advice
- CAD layout drawings – custom design, sizing chart

Value Proposition	5
Z880 Perma-Trench	6
Z886 Perma-Trench	8
Z883 Perma-Trench	10
Z882 Perma-Trench	12
Z887 Perma-Trench	15
System Installations	17
Classifications	18
Chemical Resistance Information	20
Product Codes	21



Pre-sloped Zurn modular drainage systems designed for ease of installation. Offering unparalleled quality, flow velocity and savings for collection, containment, conveyance and discharge of storm water, and wastewater.



Value Proposition



Architect and Engineer

- Durable and sustainable product
- Enhanced chemical resistance properties
- Versatile system
- Superior built-in fall creating higher flow rates
- Products independently tested and certified to comply with:
 - AS3996-2006 Access Covers and Grates
 - AS4586-2013 Slip Resistance Classification of new pedestrian surface materials
 - AS1428.2 Design for Access and Mobility
- Large selection of aesthetically appealing and functional grates for any application
- Selection of systems to suit project requirements



Contractor

- Significant labour reduction
- Significant overall cost saving
- Save up to 75% installation time with patented install features
 - Built-in rebar connections
 - Interlocking 'Male' to 'Female' connections
 - Lightweight material (reducing handling, time and labour)
 - 2 metre and 2.5 metre lengths (reducing handling, time and labour)
- Ease of setting to final elevation
- Ease of handling and safety
- Equipment hire savings



Building Owner

- Durable and sustainable product
- Self cleaning system, requires less maintenance
- Total project savings with fast and simple installation
- Aesthetically appealing finishes
- Effective and functional protection of assets

Z880 Perma-Trench

HDPE Narrow Drain System – 44mm Clear Opening

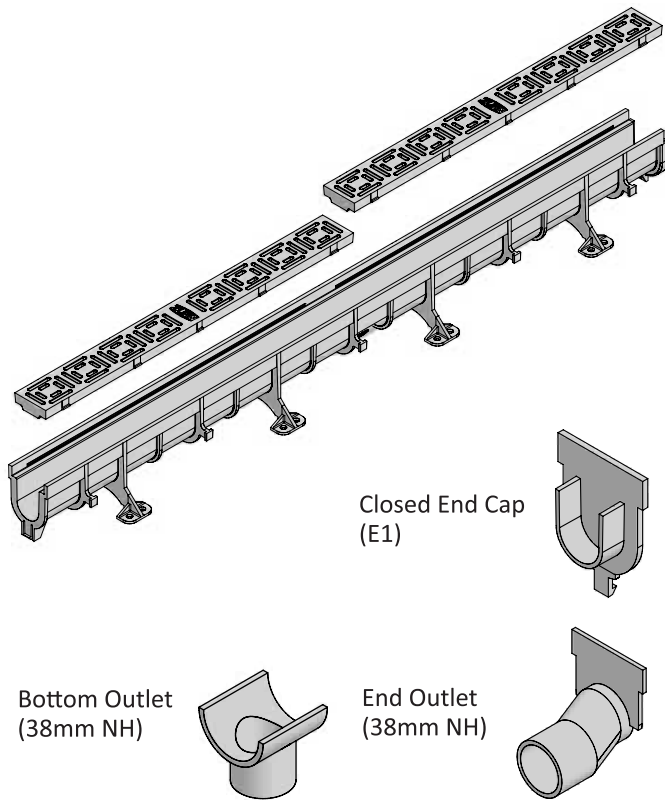

Features and Benefits

- 1220mm Pre-engineered Modular Channel Sections with 610mm Grates, along with 45 Degree and 90 Degree Angled Channels and Grates
- Durable and Lightweight – Strong corrosion-resistant material
- 76mm Invert Depth
- Prefabricated 45's and 90's
- Three Colours – Grey, Blue and Sand



- A range of Grates Class A – Independently Certified to AS3996-2006.

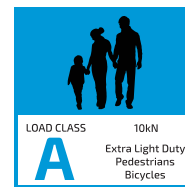

Z880 Applications

- Aquatic/Leisure Centres
- Balconies
- Landscape Areas
- Parks/Gardens
- Residential Shopping Centers
- Showers
- Swimming Pools

- Grates meet a wide variety of Legislative & User Requirements Including:



Installation Specification

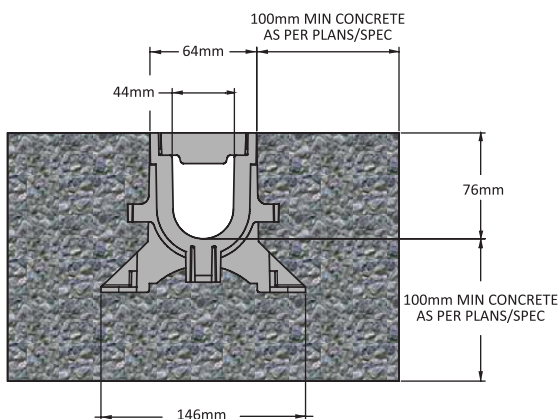

44mm Clear Opening, 64mm Overall Width
Consult Plans and Specifications

Z880 System Highlights

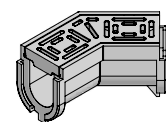
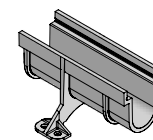
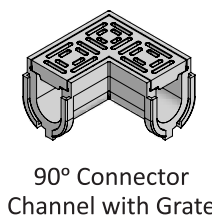

90° Connector Channel with Grate

Bedding Feet











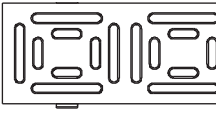

45° Connector Channel with Grate

Z880 Dimensional Data

Clear Opening	Overall Depth		Approx. Weight (Less Grate)
	C Minimum	D Maximum	
44mm	76	76	1.8

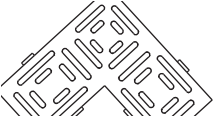
P880 Grate Options

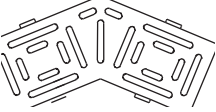
For Use With Z880 Channels

GRATE PROFILE	LOAD CLASS	CODE	DESCRIPTION	SIZE				
		P880-POG	PE Pool Grate - Grey	61 x 610mm				
		P880-POG-284-U	PE Pool Grate - Blue	61 x 610mm	✓	✓	✓	
		P880-POG-466-U	PE Pool Grate - Sand	61 x 610mm				
		P880-SSHP	S/Steel Wire Pool Grate	61 x 610mm		✓	✓	✓
		P880-SSHPPG	S/Steel Wire ProGrip Pool Grate	61 x 610mm	✓	✓	✓	✓
		P880-G90	PE 90° Pool Grate - Grey	61mm wide				
		P880-G90-284-U	PE 90° Pool Grate - Blue	61mm wide	✓	✓	✓	
		P880-G90-466-U	PE 90° Pool Grate - Sand	61mm wide				
		P880-G45	PE 45° Pool Grate - Grey	61mm wide				
		P880-G45-284-U	PE 45° Pool Grate - Blue	61mm wide	✓	✓	✓	
		P880-G45-466-U	PE 45° Pool Grate - Sand	61mm wide				



Z886 Perma-Trench

HDPE Drain System – 100mm Clear Opening



Features and Benefits

- 2032 mm Pre-engineered Modular Channel Sections with 508mm or 1016mm Grates
- .75% Built-In Slope – Handles greater flows, uniform slope, superior flow rates.
- Radiused Bottom – Better flow rate, significantly reduces sediment.
- Smooth High Density Polyethylene Structural Composite Interior – 0% water absorption.
- Durable and sustainable – Strong corrosion-resistant material.
- Lightweight Materials – Reduces labor cost, less time and manpower by up to 75%.
- Built-In Rebar Clips – Accommodates 9.5mm (#3) or 12.7mm (#4) rebar (supplied by others).
- Range of Grates meet a wide variety of Legislative & User Requirements Including:

Z886 Applications

- | | |
|---------------------------------|-----------------------|
| Shopping Centres | Driveways |
| Landscape Areas | Petrol Stations |
| Swimming Pools | Industrial Centres |
| Parks/Gardens | Highways & Freeways |
| Car Parks | Airplane Hangars |
| Food Processing | Military Bases |
| Kitchens | Large Hardscape Areas |
| Chemical Plants/
Containment | Airports |
| Pharmaceutical Plants | Docks & Ports |



AS 4586 Certified Non-Slip



AS 1428.2 Accessibility & Mobility Compliant



Bike Safe



Heel Proof

- Grates Class Range: Class A to G – Independently Certified to AS3996-2006.

LOAD CLASS 10kN
A Extra Light Duty
Pedestrians
Bicycles

LOAD CLASS 80kN
B Light Duty
Light Machinery
Low Speeds

LOAD CLASS 150kN
C Medium Duty
Automobiles
Moderate Speeds

CLASS 210kN
D Heavy Duty
Light Commercial

LOAD CLASS 400kN
E Extra Heavy Duty
Construction Vehicles

LOAD CLASS 600kN
F Extra Heavy Duty
Industrial Areas
High Speeds

LOAD CLASS 900kN
G Extra Heavy Duty
Aircraft
High Speeds

Z886 System Profile

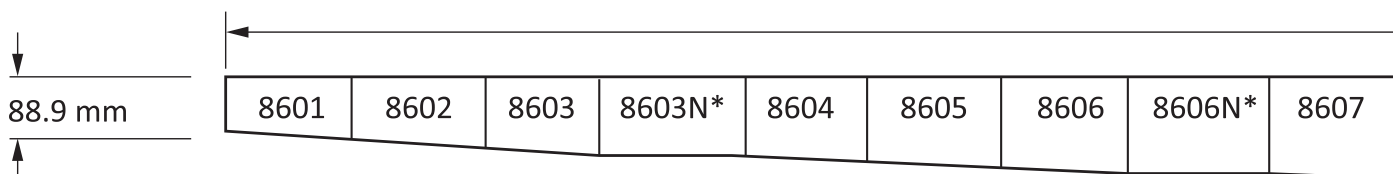

Installation Specification

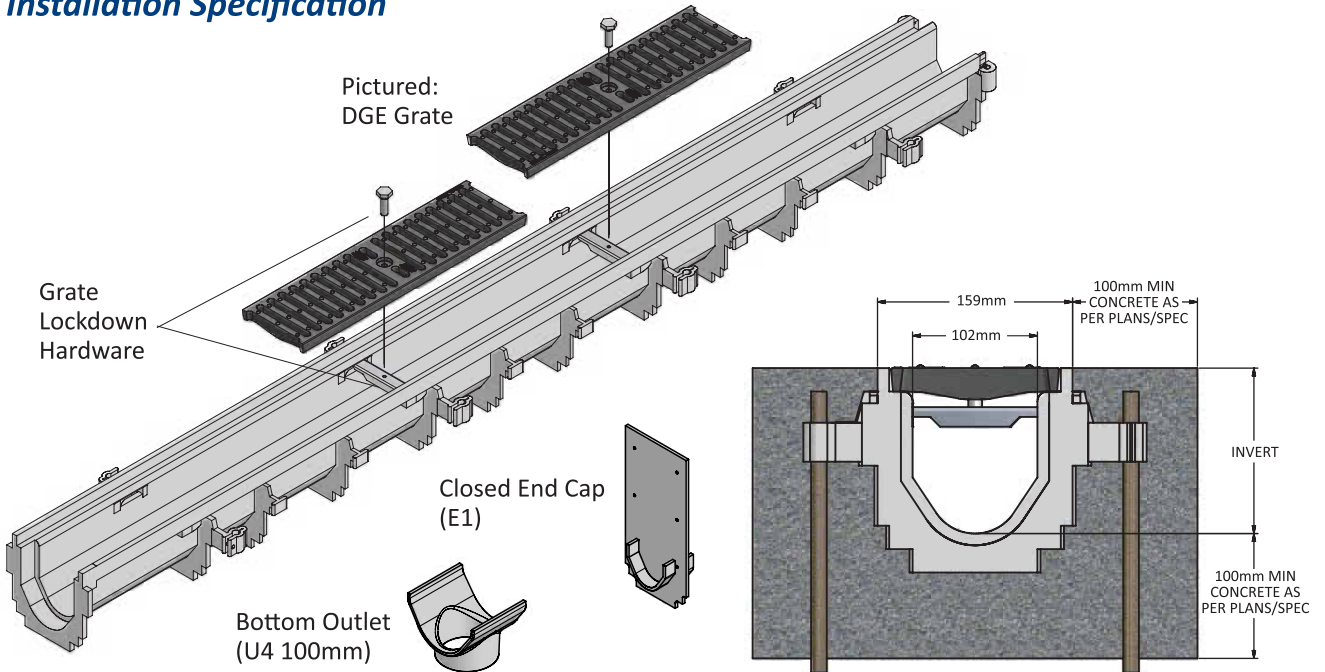

100mm Clear Opening / 159mm Overall Width
Consult Plans and Specifications

Z886 System Highlights

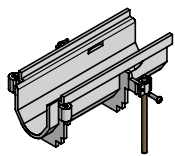

Integral Rebar Clips

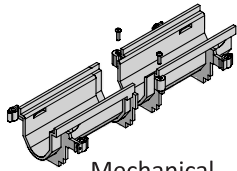

Mechanical Interlocking Connection

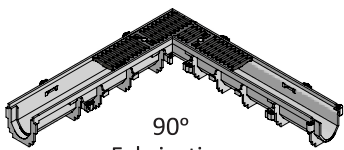

90° Fabrication

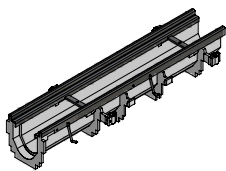

Optional -HD Frame Assembly

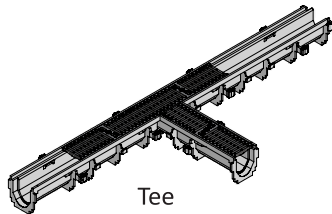

Tee Fabrication

Z886 Dimensional Data

Trench Number	Shallow Invert mm	Deep Invert LPS	Max. Flow Rate LPS	Approx. Weight (Less Grate) Kg
8601	89	104	6	6.2
8602	104	119	8	6.8
8603	119	134	10	7.4
8603N	135	135	-	7.7
8604	135	150	12	8.3
8605	150	165	14	8.9
8606	165	180	16	9.5
8606N	180	180	-	10.0
8607	180	196	17	10.6
8608	196	211	19	11.2
8609	211	226	21	11.8
8610	226	241	23	12.4
8611	241	257	26	13.0
8612	257	272	28	13.6
8612N	272	272	-	13.6
8613	272	287	30	14.2
8614	287	302	32	14.8
8615	302	318	34	15.4

39.62 m

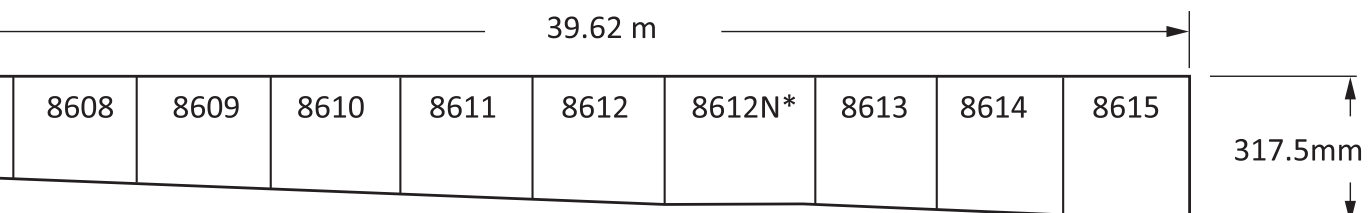

Z883 Perma-Trench

PP 100mm Clear Opening – 89mm Depth



Z883 Applications

- Pedestrian/Sidewalks
- Kitchens
- Landscape Areas
- Pools
- Residential Thresholds
- Balconies/Terraces
- Schools

Features and Benefits

- 1016mm Pre-engineered Neutral Modular Channel Sections with 508mm or 1016mm Grates
- Smooth Seamless Construction – Clean, sanitary installation.
- Durable and Lightweight – Strong corrosion-resistant material.
- 89mm Trench Depth – For depth restricted applications
- Optional – Stainless veneer frame
- Built-In Rebar Clips – Accommodates 9.5mm (#3) rebar (not supplied).
- Range of Grates meet a wide variety of Legislative & User Requirements Including:



- Grates Class Range: A to C – Independently Certified to AS3996-2006.

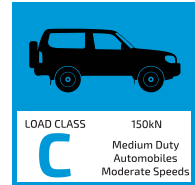
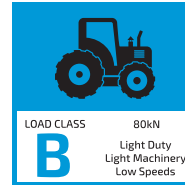
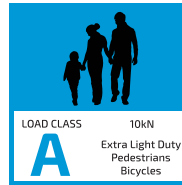

Installation Specification

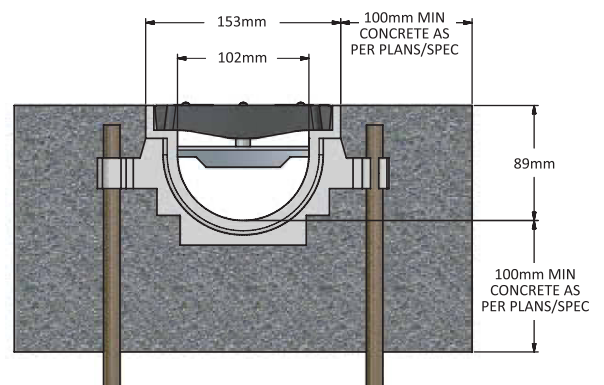
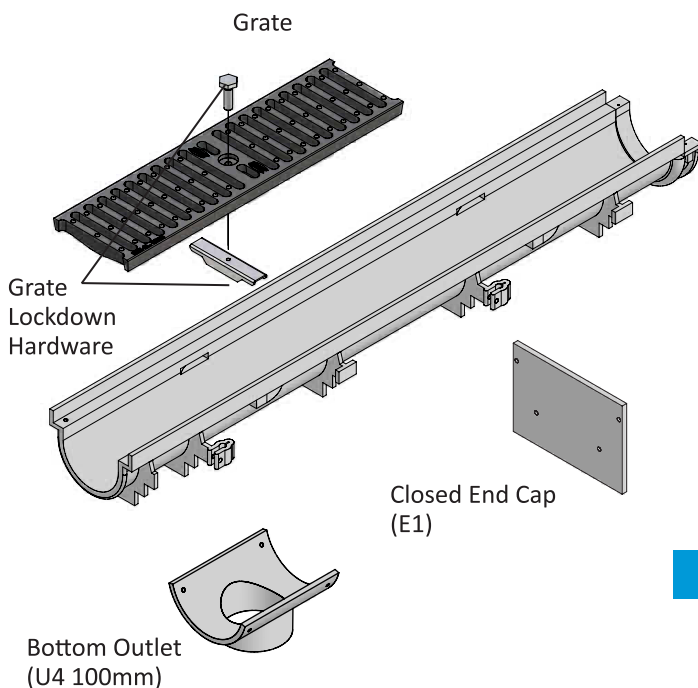















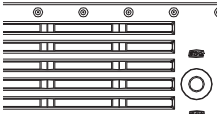

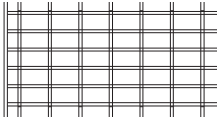

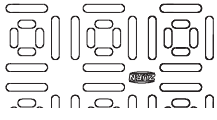

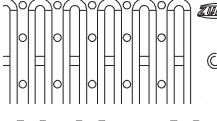





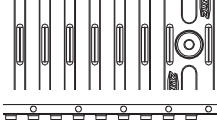

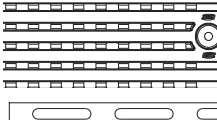

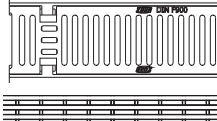
100mm Clear Opening, 153mm Overall Width
Consult Plans and Specifications

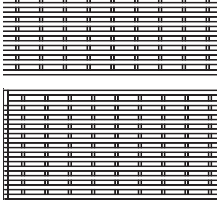
Z883 Dimensional Data

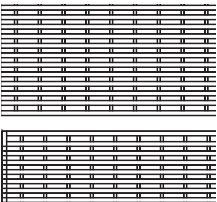
Clear Opening	Overall Depth		Approx. Weight (Less Grate)
	C Minimum	D Maximum	
100mm	89	89	Kg
			1.8

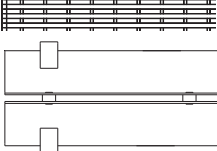
P6 Grate Options

For Use With Z886 & Z883 Channels*

GRATE PROFILE	LOAD CLASS	CODE	DESCRIPTION	SIZE				
		P6-HPP-DARK-GREY	HDPE HeelProof Longitudinal Grate	137 x 506mm	✓	✓	✓	✓
		P6-HPP-BLACK	HDPE HeelProof Longitudinal Grate	137 x 506mm	✓	✓	✓	✓
		P6-GMG	Gal. Steel Mesh Grate	137 x 1016mm			✓	
		P6-SMG	304 S/Steel Mesh Grate	137 x 1016mm			✓	
		P6-DOG	DI Ornamental Grate	137 x 506mm		✓	✓	✓
		P6-RFGC	Gal. Steel Reinforced Slotted Grate	137 x 1016mm	✓	✓	✓	
		P6-RFSC	304 S/Steel Reinforced Slotted Grate	137 x 1016mm	✓	✓	✓	
		P6-DCD	DI Circular Decorative Grate	137 x 508mm		✓	✓	✓
		P6-DTW	DI Tidal Wave Deco. Grate	137 x 506mm	✓	✓	✓	✓
		P6-DGE	DI Slotted Grate	137 x 506mm		✓	✓	✓
		P6-GDE	Gal. DI Slotted Grate	137 x 506mm		✓	✓	
		P6-HPDE-OS	DI HeelProof Longitudinal Grate	137 x 506mm	✓	✓	✓	✓
		P6-GHPDE	Gal. DI HeelProof Longitudinal Grate	137 x 506mm	✓	✓	✓	✓
		P886-FGF	(Z886) DI Slotted Grate & Frame	140 x 507mm		✓	✓	✓
		P6-SSHP-A	304 S/Steel HeelProof Grate	137 x 1016mm		✓	✓	✓
		P6-HMSSHPPG-A	304 S/Steel HeelProof Grate	137 x 508mm		✓	✓	✓
		P6-SSHP-C	304 S/Steel HeelProof ProGrip Grate	137 x 1016mm	✓	✓	✓	✓
		P6-HMSSHPPG-C	304 S/Steel HeelProof ProGrip Grate	137 x 508mm	✓	✓	✓	✓
		P6-SSHP-A-316	316 S/Steel HeelProof Grate	137 x 1016mm		✓	✓	✓
		P6-HMSSHPPG-A-316	316 S/Steel HeelProof Grate	137 x 508mm		✓	✓	✓
		P6-SSHP-C-316	316 S/Steel HeelProof ProGrip Grate	137 x 1016mm	✓	✓	✓	✓
		P6-HMSSHPPG-C-316	316 S/Steel HeelProof ProGrip Grate	137 x 508mm	✓	✓	✓	✓
		P6-SSHP-C-316	316 S/Steel HeelProof Grate	137 x 1016mm		✓	✓	✓
		P6-HMSSHPPG-C-316	316 S/Steel HeelProof Grate	137 x 508mm		✓	✓	✓
		P6-SSHP-C-316	316 S/Steel HeelProof ProGrip Grate	137 x 1016mm	✓	✓	✓	✓
		P6-HMSSHPPG-C-316	316 S/Steel HeelProof ProGrip Grate	137 x 508mm	✓	✓	✓	✓
		P886-PVSG	Gal. Steel Paver Slot Grate	137 x 1016mm		✓	✓	✓
		P886-PVSS	304 S/Steel Paver Slot Grate	137 x 1016mm		✓	✓	✓

*Excludes P886-FGF for use only with Z886.

*Z883 Channels offer a maximum rating of C Load Class when combined with any higher rated P6-Grate.

Z882 Perma-Trench

HDPE Drain System – 235mm Clear Opening



Features and Benefits

- **2500mm Pre-engineered Modular Channel Sections with 610mm or 1220mm Grates**
- **1.04% Built-In Slope** – *Handles greater flows, uniform slope, superior flow rates.*
- **Radiused Bottom** – *Better flow rate, significantly reduces sediment.*
- **Smooth High Density Polyethylene Structural Composite Interior** – *0% water absorption.*
- **Durable and sustainable** – *Strong corrosion-resistant material.*
- **Lightweight Materials** – *Reduces labor cost, less time and manpower by up to 75%.*
- **Built-In Rebar Clips** – *Accommodates 9.5mm (#3) or 12.7mm (#4) rebar (supplied by others).*
- **Range of Grates meet a wide variety of Legislative & User Requirements Including:**

Z882 Applications

- | | |
|-----------------------|-----------------------|
| Shopping Centres | Petrol Stations |
| Landscape Areas | Industrial Centres |
| Swimming Pools | Highways & Freeways |
| Parks/Gardens | Airplane Hangars |
| Car Parks | Military Bases |
| Food Processing | Large Hardscape Areas |
| Kitchens | Airports |
| Chemical Plants | Docks & Ports |
| Pharmaceutical Plants | |
| Driveways | |



AS 4586 Certified Non-Slip



AS 1428.2 Accessibility & Mobility Compliant



Bike Safe



Heel Proof

- **Grates Class Range: Class A to G** – *Independently Certified to AS3996-2006.*

LOAD CLASS 10kN
A Extra Light Duty
Pedestrians
Bicycles

LOAD CLASS 80kN
B Light Duty
Light Machinery
Low Speeds

LOAD CLASS 150kN
C Medium Duty
Automobiles
Moderate Speeds

CLASS 210kN
D Heavy Duty
Light Commercial

LOAD CLASS 400kN
E Extra Heavy Duty
Construction Vehicles

LOAD CLASS 600kN
F Extra Heavy Duty
Industrial Areas
High Speeds

LOAD CLASS 900kN
G Extra Heavy Duty
Aircraft
High Speeds

Z882 System Profile

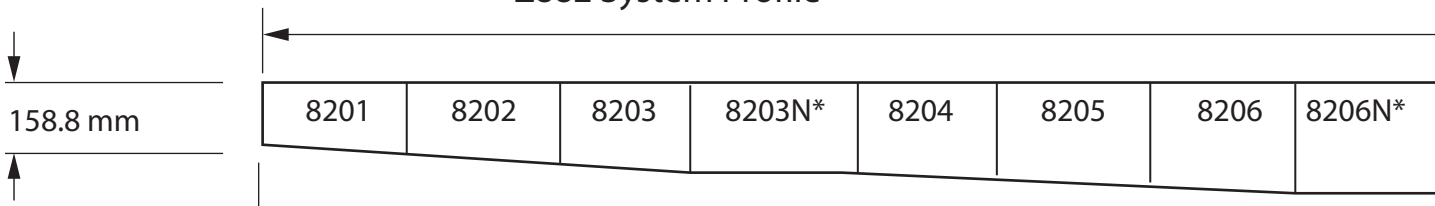

Installation Specification

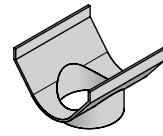
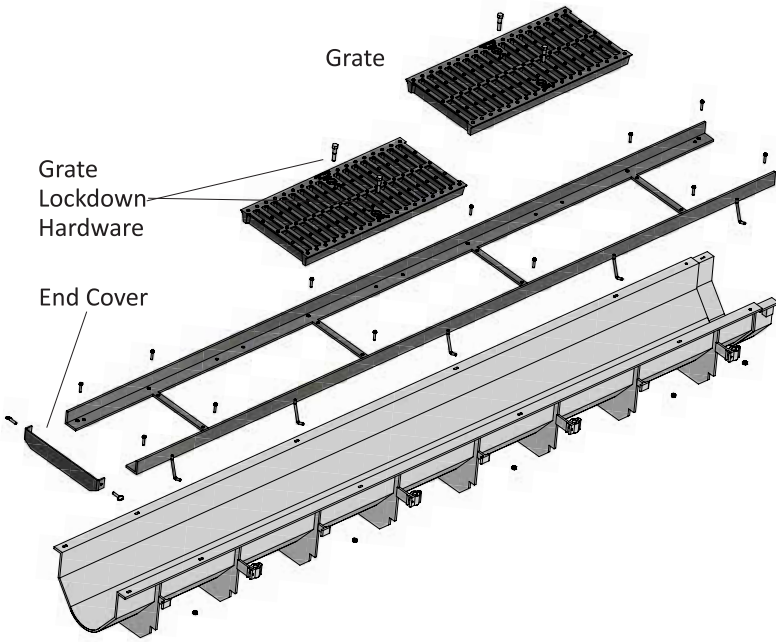

Closed End Cap (E1)

Bottom Outlet (U6, U8, 150mm, 225mm)

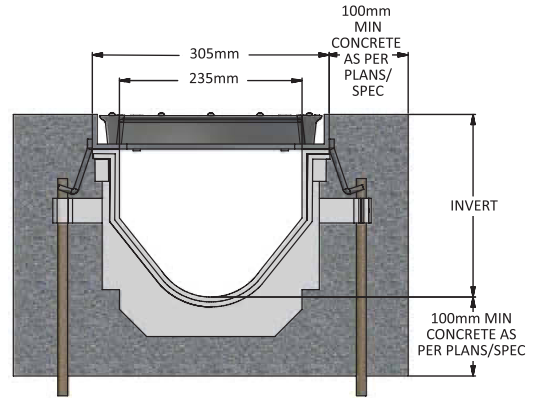
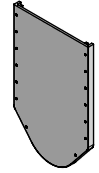

235mm Clear Opening / 305mm Overall Width
Consult Plans and Specifications

Z882 System Highlights

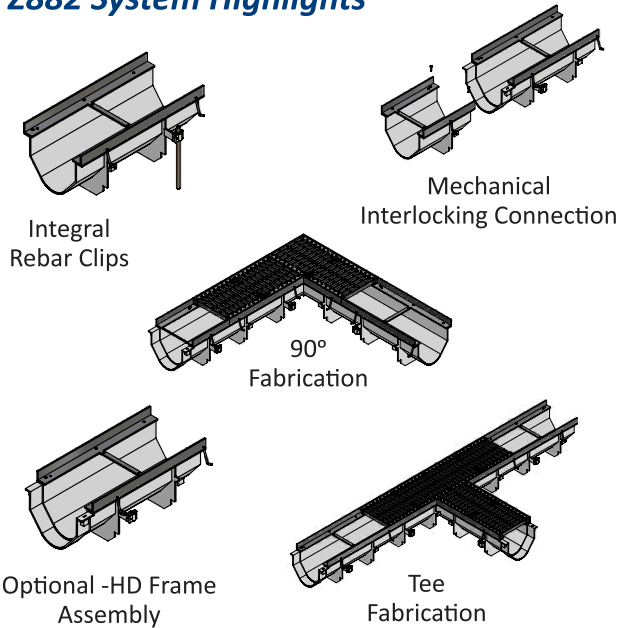

Z882 includes Black Epoxy coated frame.
Stainless Steel or Galvanised Steel Options also available.





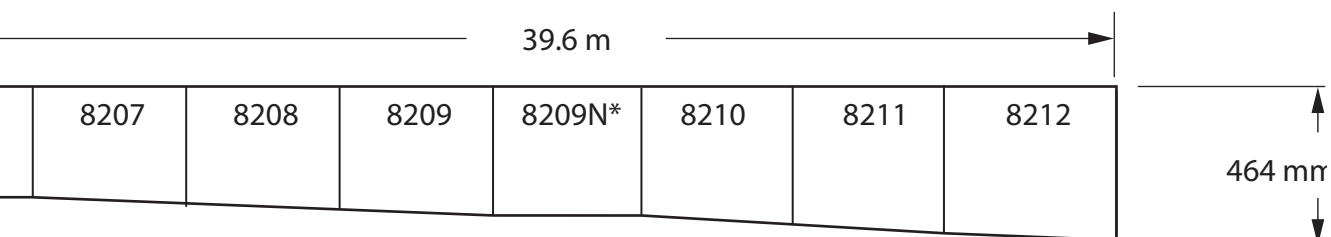









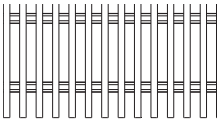

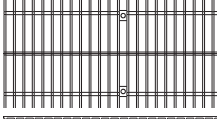



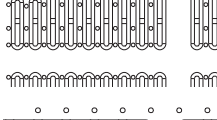

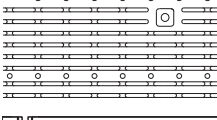

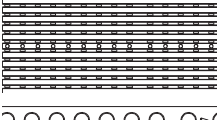

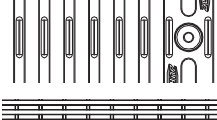

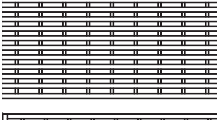

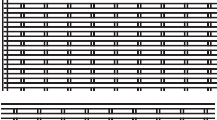

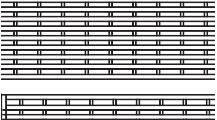

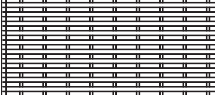
Z882 Dimensional Data

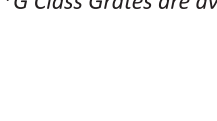
Trench Number	Shallow Invert mm	Deep Invert LPS	Max. Flow Rate LPS	Approx. Weight (Less Grate) Kg
8201	159	184	35	30.8
8202	184	210	49	30.8
8203	210	235	63	31.8
8203N	235	235	-	32.2
8204	235	260	78	32.7
8205	260	286	93	34.0
8206	286	311	108	34.9
8206N	311	311	-	35.4
8207	311	337	123	35.8
8208	337	362	139	36.3
8209	362	387	155	37.7
8209N	387	387	-	38.1
8210	387	413	170	38.6
8211	413	438	186	39.5
8212	438	464	202	40.4



P12 Grate Options

For Use With Z882 Channels*

GRATE PROFILE	LOAD CLASS	CODE	DESCRIPTION	SIZE				
		P12-GG	Vinylester Fibreglass Ladder Grate	289 x 610mm	✓		✓	
		P12-BG-L	Gal. Steel Light Duty Bar Grate	286 x 610mm			✓	
		P12-SBG-L	304 S/Steel Bar Grate	286 x 610mm			✓	
		P12-RFGC	Gal. Steel Reinforced Slotted Grate	289 x 610mm		✓	✓	✓
		P12-RFSC	304 S/Steel Reinforced Slotted Grate	289 x 610mm		✓	✓	✓
		P12-HPD	DI HeelProof Longitudinal Grate	285 x 610mm		✓	✓	✓
		P12-HPDE	DI HeelProof Longitudinal Grate	285 x 610mm	✓	✓	✓	✓
		P12-GHPDE	Gal. DI HeelProof Longitudinal Grate	285 x 610mm		✓	✓	✓
		P12-DGE	DI Slotted Grate	286 x 608mm		✓	✓	✓
		P12-SSHPPG-A	304 S/Steel HeelProof ProGrip Grate	289 x 1220mm	✓	✓	✓	✓
		P12-HMSSHPPG-A	304 S/Steel HeelProof ProGrip Grate	289 x 610mm				
		P12-SSHPPG-C	304 S/Steel HeelProof ProGrip Grate	289 x 1220mm	✓	✓	✓	✓
		P12-HMSSHPPG-C	304 S/Steel HeelProof ProGrip Grate	289 x 610mm				
		P12-SSHPPG-A-316	316 S/Steel HeelProof ProGrip Grate	289 x 1220mm	✓	✓	✓	✓
		P12-HMSSHPPG-A-316	316 S/Steel HeelProof ProGrip Grate	289 x 610mm				
		P12-SSHPPG-C-316	316 S/Steel HeelProof ProGrip Grate	289 x 1220mm	✓	✓	✓	✓
		P12-HMSSHPPG-C-316	316 S/Steel HeelProof ProGrip Grate	289 x 610mm				

*G Class Grates are available as special order items only and require additional lead time.

Z887 Perma-Trench

Drainage Pits



Z882 Applications

Shopping Centres
Landscape Areas
Swimming Pools
Parks/Gardens
Car Parks
Food Processing
Kitchens
Chemical Plants
Pharmaceutical Plants
Driveways

Petrol Stations
Industrial Centres
Highways & Freeways
Airplane Hangars
Military Bases
Large Hardscape Areas
Airports
Docks & Ports

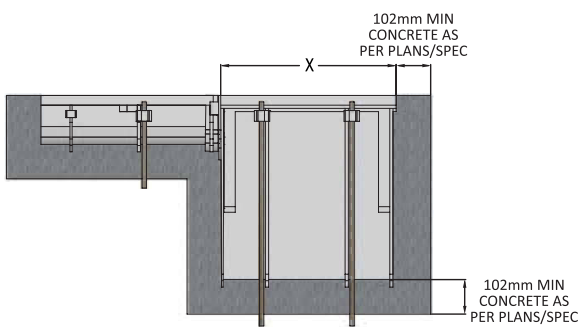

Consult Plans and Specifications

Z887 Dimensional Data

Pit Code	Overall Top Dimensions		Approx. Weight (Less Grate)
	Length	Width	
	mm	LPS	Kg
Z887-6	159	508	7.7
Z887-12	591	305	6.6
Z887-24	591	625	9.0
Z887-EXT	591	625	4.6

Features and Benefits





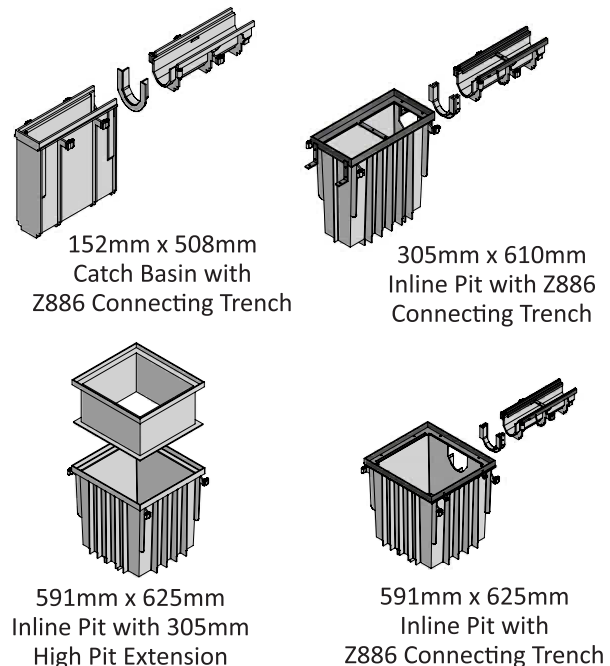









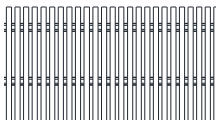

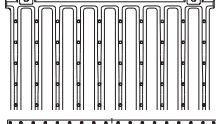

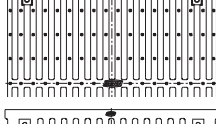

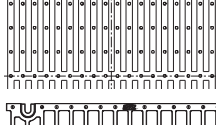

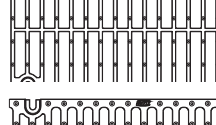

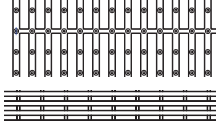

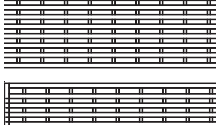

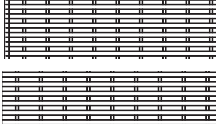

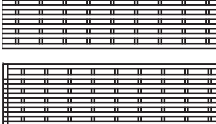





- **Z887 - 6 Inline Pit** – The 152mm x 508mm Inline Pit is for use as an in-line pit for applications where, from the top surface, the visual appearance is of continuous 152mm wide Z886/Z883 trenching. Simply trace and cut the trench section to be connected into the end of the basin, insert into the basin, bolt together, and caulk around the exterior. For grate options, refer to P6 Grate Options.
- **Z887 - 12 Inline Pit** – The 624mm x 305mm Inline Pit can be utilised as an inline pit for the Z882 trench system, or as a pit for the Z886 trench system to cater for larger capacities.
- **Z887 - 24 Inline Pit** – The 591mm x 625mm Inline Pit provides greater capacities for larger trench runs. These drainage pits can be used with Z882 and Z886 trenches and have an external trench adapter supplied to make the transition between the trench and pit (see illustration). This adapter, enables a fast and easy connection. Additional adapters can be used to make numerous connections of trench into the pit. For grates, refer to P887 Grate Options.
- **Z887-EXT Drainage Pit Extension Riser for Z887-24** – This 305mm polyethylene extension for Z887 - 24 Drainage Pit provides greater depths and capacities. These riser units are stackable, allowing for depths in 305mm increments.

Z887 System Highlights

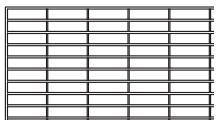

P817/887 Grate Options

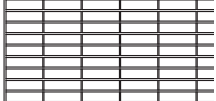
For Use With Z887 Pits

GRATE PROFILE	LOAD CLASS	CODE	DESCRIPTION	SIZE				
		P817-GG-24X24	Vinylester Fibreglass Ladder Grate	600x600mm	✓	✓	✓	✓
		P817-DGC-24X24	DI Slotted Grate	600x600mm		✓	✓	✓
		P817-GDC-24X24	Gal. DI Slotted Grate	600x600mm		✓	✓	✓
		P817-DGF-24X24	DI Slotted Grate	600x 600mm		✓	✓	✓
		P12-DGC-3	Milled Ductile Iron Slotted Grate	300x600mm		✓	✓	✓
		P12-DGE-3	Milled Ductile Iron Slotted Grate	300x600mm		✓	✓	✓
		P817-SSHPA-304-24	304 S/Steel HeelProof Grate	600x600mm		✓	✓	✓
		P817-SSHPPG-A-304-24	304 S/Steel HeelProof ProGrip Grate	600x600mm	✓	✓	✓	✓
		P817-SSHP-C-304-24	304 S/Steel HeelProof Grate	600x600mm		✓	✓	✓
		P817-SSHPPG-C-304-24	304 S/Steel HeelProof ProGrip Grate	600x600mm	✓	✓	✓	✓
		P817-SSHPA-316-24	316 S/Steel HeelProof Grate	600x600mm		✓	✓	✓
		P817-SSHPPG-A-316-24	316 S/Steel HeelProof ProGrip Grate	600x600mm	✓	✓	✓	✓
		P817-SSHP-C-316-24	316 S/Steel HeelProof Grate	600x600mm		✓	✓	✓
		P817-SSHPPG-C-316-24	316 S/Steel HeelProof ProGrip Grate	600x600mm	✓	✓	✓	✓
		P817-BG-L-24X24	Gal. Steel Light Duty Bar Grate	575x610mm			✓	
		P817-BG-M-24X24	Gal. Steel Bar Grate	575x610mm			✓	

General Information

Versatility best defines LWG Zurn Trench Drain systems. Unlike other channel drainage systems, LWG Zurn systems can be installed using various techniques to meet job conditions.

Two workers can easily pick up and set in place up to a 6096mm assembled section (less grates) of LWG Zurn channels, securing into position and setting to finished elevation more efficiently. Longer length channels in the LWG Zurn systems result in a better installation with fewer joints.

Note: Angle iron frame must be anchored in concrete. Voids in the concrete pour or removal of concrete around the frame may result in a trench failure. When epoxy coated floors are used, the concrete pour should be planned so as to allow floor coating to be applied flush to the angle iron top or above without the removal or disturbing of concrete around the frame.

Installation Tips

- Always begin trench installation at the outlet end and work upstream
- Always follow standard concrete installation methods including vibration under and around both sides of trench
- Excavation can be dug with a gradual slope (trench channels have built-in sloping invert)
- Install trench at approx 3mm below finished floor elevation for positive fall into trench
- All-thread rod offers more up and down flexibility for finish grade
- Rebar clips accommodate #3 or #4 rebar

The minimum concrete surround is 100mm but is usually based upon the thickness of slab. Consult structural engineer's specifications on plans.

Suspended installation is the most widely practiced installation method on an existing slab or where form boards can be utilized to hold channel sections in place.

Use 50mm x 100mm (4x2) boards of sufficient length to span trench (minimum of 100mm of concrete on either side of trench) and 75mm long bolts or all-thread rods, nuts, and washers. Secure the channel to the boards, either through attachment to the rebar clips or grate lockdown bar. Follow the shop drawings or engineered layout of channels. Position each channel section (channels are numbered in sequence) end to end by inserting the mechanical joint together for proper alignment and grade.

Rebar clip installation is best suited for new construction. Prepare trench excavation and pull stringline for proper elevation and straightness. Place cut rebar lengths inside rebar clips. Set trench in ditch, connecting each joint. Beginning at the outlet end, drive rebar stakes into ground. Raise the trench to finished floor elevation and secure screw into rebar clip. Set concrete under and evenly on both sides of trench drain in 150mm lifts to finished floor elevation.

Refer to www.lwgzurn.com and/or product specification. Detailed Installation Instructions available.

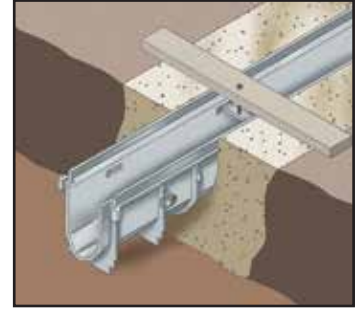

Suspended Installation
Z886 Perma-Trench Illustrated

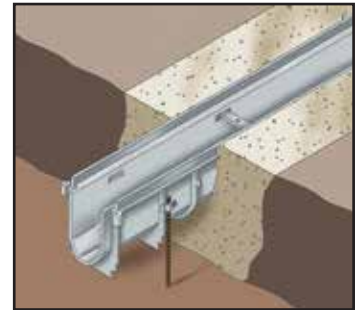

Rebar Clip Installation
Z886 Perma-Trench Illustrated

	SUSPENDED INSTALLATION	REBAR CLIP INSTALLATION
Z886	X	X
Z883	X	X
Z882	X	X
Z880	X	

Material Definitions

ACID-RESISTING EPOXY COATING (A.R.C.) is a baked-on powder coating which produces a smooth, hard, high-gloss finish. This epoxy-based coating offers high impact resistance and excellent life expectancy in all drainage applications.

DUCTILE IRON (DI.) has physical properties which make it ideal for grates and drain components that are subjected to severe and heavy-duty service. Its chemical characteristics make possible a degree of corrosion resistance far superior to that of cast iron.

GALVANIZING STEEL (GAL.) is a process of applying a coating of zinc to the finished sheet or fabricated parts to provide corrosion resistant properties. The coating is applied by hot dipping or electrolytic deposition.

POLYESTER is a thermosetting resin utilized to bond the individual fibres during the manufacture of moulded fiberglass components. It provides high durability and excellent chemical and weather resistant properties.

POLYETHYLENE, HIGH DENSITY (HDPE) is a thermoplastic resin that offers excellent physical characteristics such as light weight, outstanding chemical resistance to household and industrial chemicals, robust, and zero water absorption.

POLYPROPYLENE (PP) (also known as Polypropene) is a thermoplastic that offers excellent physical characteristics such as light weight, outstanding chemical and impact resistance, and zero water absorption.

STAINLESS STEEL (SS or S/Steel) is any steel containing four or more percent chromium content. Chromium, along with other alloying elements like nickel and silicon, provides corrosion and heat resistant characteristics. Type 304 stainless steel is typical with 316 available as an option.

STAINLESS STEEL HARDWARE is used to secure steel angle frame to fiberglass trench for all Zurn Trench Systems.

VINYLESTER is a thermosetting resin utilized in the manufacture of moulded fiberglass components. Its superior corrosion resistance in acidic and alkaline services, along with excellent impact and flexural fatigue resistance, make it ideal for hazardous chemical applications.

Glossary

LWG, LWG ZURN, AND LWG ZURN AUSTRALIA - All refer to LWG Zurn Australia P/L a division of Zurn Industries, LLC.

FAB. - Fabricated

HD - Heavy Duty

NEUTRAL - Non-sloping channel drain

PRESLOPED - Built-in slope (see individual Specification Sheets for details)

Grate Loading Classifications

AS3996 - 2006 LOAD CLASSIFICATIONS

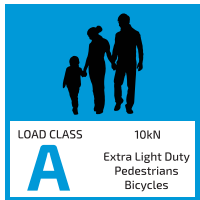

LOAD CLASS A 10KN

Footways trafficable only to pedestrians and non motorised cyclists, closed to all other traffic. (EXTRA LIGHT DUTY) Approximate Wheel Load: 330kg

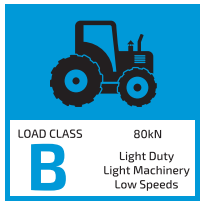

LOAD CLASS B 80KN

Footways accessible to light vehicles, livestock and light tractor paths. (LIGHT DUTY) Approximate Wheel Load: 2,670kg

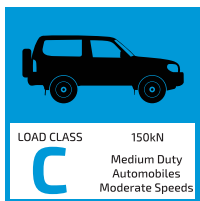

LOAD CLASS C 150KN

Malls and open areas open to slow commercial vehicles. (MEDIUM DUTY) Approximate Wheel Load: 5,000kg

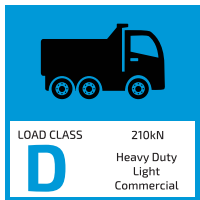

LOAD CLASS D 210KN

Carriageways of roads open to commercial vehicles. (HEAVY DUTY) Approximate Wheel Load: 8,000kg

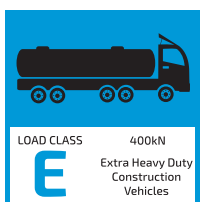

LOAD CLASS E 400KN

General Docks & Aircraft Pavements. (EXTRA HEAVY DUTY) Approximate Wheel Load: 13,700kg

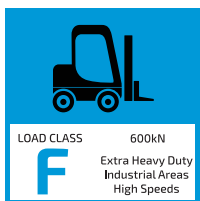

LOAD CLASS F 600KN

Docks & Aircraft pavements subject to high wheel loads. (EXTRA HEAVY DUTY) Approximate Wheel Load: 20,000kg

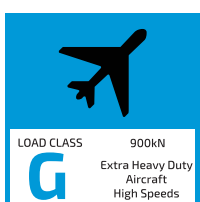

LOAD CLASS G 900KN

Docks & Aircraft pavements subject to Very high wheel loads. (EXTRA HEAVY DUTY) Approximate Wheel Load: 30,000kg

AS3996 - 2006 LOAD CLASSIFICATIONS



BIKE SAFE - AS3996-2006 - 3.3.6

LWG Zurn supply a large range of grates compliant with criteria set out to resist bicycle tyre penetration. The standard is designed so bicycle tyres are not caught or tramlined and ensure safety of cyclists.



AS4586-2013 SLIP RESISTANCE CLASSIFICATION OF NEW PEDESTRIAN SURFACE

The objective of this standard is to provide users and specifiers of pedestrian surface material such as drainage grates with a means for classifying surfaces according to their pedestrian slip resistance for use in a selection of surfaces.

LWG Zurn is committed to having grates independently tested to comply with the Standards outlined.



AS 1428.2 ACCESSIBILITY & MOBILITY COMPLIANT CLAUSE 9 (C)

The objective of this section of the Standard is to ensure the utmost safety for impaired pedestrians.

"If gratings are located in a walking surface, they shall have spaces not more than 13mm wide and not more than 150mm long. If gratings have elongated openings, they shall be placed so that the long dimension is transverse to the dominant direction of travel."



HEELPROOF

Heelproof is an adopted standard to resist penetration of stiletto heels in grate openings to prevent trips and falls.

LWG Zurn boast a large range of high quality Heelproof grates with aesthetically appealing designs in a range of load classes to cater for many shared use zone applications with pedestrians and vehicles.

A majority of LWG Zurn's Heelproof grates are; slip resistant, Accessibility and Mobility compliant and bike safe.

Technical Data

Chemical Resistance Information

Perma-Trench Drainage System

Below chart shows chemical resistance of high density polyethylene structural composite to select chemicals and temperatures at the maximum concentration percentage. For a full listing of chemicals, please visit www.lwgzurn.com or contact your LWG Zurn Sales Representative.

KEY	
a	Unaffected
b	Slightly Attacked
c	Attacked
-	Unknown

Chemical	Concentration	20°C	50°C	Max Temp (°C)	Chemical	Concentration	20°C	50°C	Max Temp (°C)
A					M				
Acetate Solvents	Pure	a	-	21.11	Machine Oil	all	a	-	20
Acetic Acid	97%	a	b	60	Meat Juices	-	a	a	-
Acetone	all	b	b	60	Methanol	all	a	-	20
Alcohol	all	a	a	60	Methyl Alcohol	all	a	-	20
Aluminum Chloride	all	a	a	60	Milk	all	a	a	60
Ammonia	all	a	c	20	N				
Ammonium Hydroxide	20%	a	a	-	Nitric Acid	70%	a	c	-
B					Nitrobenzene	100	a	a	-
Battery Acid	all	a	a	60	O				
Beer	all	a	a	60	Oil- Diesel Fuel	-	a	a	-
Borax	all	a	a	60	Oil- Engine	-	a	a	-
Boric Acid	-	a	a	-	P				
Brake Fluid	all	a	a	60	Paraffin	100	b	b	-
Bromic Acid	10%	a	a	60	Phosphoric Acid	90%	a	a	60
Butyl Acetate	100	c	c	-	Photographic Developer	-	a	a	-
Butyl Alcohol	100	a	a	-	Q				
C					R				
Calcium Carbide	all	a	a	60	Rust Inhibitors	-	a	a	-
Calcium Chloride	all	a	a	60	S				
Calcium Hypochlorite	all	a	a	60	Sea Water	-	a	a	-
Chlorinated Pool Water	-	a	-	40.56	Silicone	-	a	a	-
Chromic Acid	50%	b	b	-	Sodium Carbonate	all	a	a	60
Citrus Juices	all	a	a	60	Sodium Hydroxide	1%	a	a	-
D					Sodium Hydroxide	100%	a	a	60
Detergents	2	a	a	-	Sodium Nitrate	50%	a	a	60
Diesel Fuel	-	b	b	-	Sodium Nitrite	-	a	a	-
E					Sulfuric Acid	60	a	b	-
Ethanol	96	a	a	60	T				
Ethyl Alcohol	96	a	a	60	Tetralilin	100	c	c	-
Ethylene Dichloride	-	b	b	-	Triethylene Glycol	-	a	a	-
F					Tripropylene Glycol	-	a	a	-
Formaldehyde	10%	a	a	60	Turpentine	-	b	b	-
G					U				
Glycerine	-	a	a	-	Urine	all	a	a	60
H					V				
Heptane	-	b	b	-	Vinegar	all	a	a	60
Hydraulic Fluid	all	a	-	20	W				
Hydrochloric Acid	5%	a	a	-	Water, Distilled	all	a	a	60
Hydrogen Peroxide	90%	a	a	-	Whiskey	-	a	a	-
I					White Paraffin	100	a	b	-
Iodine	Crystals	c	c	-	White Spirit	100	b	c	-
Isooctane	100%	c	c	-	Wines	-	a	a	-
Isobutyl Alcohol	-	a	a	-	X				
J					Xylene	-	c	c	-
K					Y				
L					Yeast	-	a	a	-
Lacquer Thinner	-	b	c	-	Z				
Lime	-	a	a	-	Zinc Oxide	all	a	a	60
					Zinc Sulfate	all	a	a	60

Technical Data

Channel Codes

Z886	DESCRIPTION	DIMENSIONS	Shallow Invert mm	Deep Invert mm	Weight (approx) Kg	Max. Flow Rate LPS
Z886-8601	Z886 100mm Clear Opening HDPE Channel - Channel 1 Presloped	100mm x 2032mm	89	104	6.2	6
Z886-8602	Z886 100mm Clear Opening HDPE Channel - Channel 2 Presloped	100mm x 2032mm	104	119	6.8	8
Z886-8603	Z886 100mm Clear Opening HDPE Channel - Channel 3 Presloped	100mm x 2032mm	119	134	7.4	10
Z886-8603N	Z886 100mm Clear Opening HDPE Channel - Channel 3 Neutral	100mm x 2032mm	135	135	7.7	-
Z886-8604	Z886 100mm Clear Opening HDPE Channel - Channel 4 Presloped	100mm x 2032mm	135	150	8.3	12
Z886-8605	Z886 100mm Clear Opening HDPE Channel - Channel 5 Presloped	100mm x 2032mm	150	165	8.9	14
Z886-8606	Z886 100mm Clear Opening HDPE Channel - Channel 6 Presloped	100mm x 2032mm	165	180	9.5	16
Z886-8606N	Z886 100mm Clear Opening HDPE Channel - Channel 6 Neutral	100mm x 2032mm	180	180	10.0	-
Z886-8607	Z886 100mm Clear Opening HDPE Channel - Channel 7 Presloped	100mm x 2032mm	180	196	10.6	17
Z886-8608	Z886 100mm Clear Opening HDPE Channel - Channel 8 Presloped	100mm x 2032mm	196	211	11.2	19
Z886-8609	Z886 100mm Clear Opening HDPE Channel - Channel 9 Presloped	100mm x 2032mm	211	226	11.8	21
Z886-8610	Z886 100mm Clear Opening HDPE Channel - Channel 10 Presloped	100mm x 2032mm	226	241	12.4	23
Z886-8611	Z886 100mm Clear Opening HDPE Channel - Channel 11 Presloped	100mm x 2032mm	241	257	13.0	26
Z886-8612	Z886 100mm Clear Opening HDPE Channel - Channel 12 Presloped	100mm x 2032mm	257	272	13.6	28
Z886-8612N	Z886 100mm Clear Opening HDPE Channel - Channel 12 Neutral	100mm x 2032mm	272	272	13.6	-
Z886-8613	Z886 100mm Clear Opening HDPE Channel - Channel 13 Presloped	100mm x 2032mm	272	287	14.2	30
Z886-8614	Z886 100mm Clear Opening HDPE Channel - Channel 14 Presloped	100mm x 2032mm	287	302	14.8	32
Z886-8615	Z886 100mm Clear Opening HDPE Channel - Channel 15 Presloped	100mm x 2032mm	302	318	15.4	34

Z882	DESCRIPTION	DIMENSIONS	Shallow Invert mm	Deep Invert mm	Weight (approx) Kg	Max. Flow Rate LPS
Z882-8201	Z882 235mm Clear Opening HDPE Channel - Channel 1 Presloped	235mm x 2438mm	159	184	30.8	35
Z882-8202	Z882 235mm Clear Opening HDPE Channel - Channel 2 Presloped	235mm x 2438mm	184	210	30.8	49
Z882-8203	Z882 235mm Clear Opening HDPE Channel - Channel 3 Presloped	235mm x 2438mm	210	235	31.8	63
Z882-8203N	Z882 235mm Clear Opening HDPE Channel - Channel 3 Neutral	235mm x 2438mm	235	235	32.2	-
Z882-8204	Z882 235mm Clear Opening HDPE Channel - Channel 4 Presloped	235mm x 2438mm	235	260	32.7	78
Z882-8205	Z882 235mm Clear Opening HDPE Channel - Channel 5 Presloped	235mm x 2438mm	260	286	34.0	93
Z882-8206	Z882 235mm Clear Opening HDPE Channel - Channel 6 Presloped	235mm x 2438mm	286	311	34.9	108
Z882-8206N	Z882 235mm Clear Opening HDPE Channel - Channel 6 Neutral	235mm x 2438mm	311	311	35.4	-
Z882-8207	Z882 235mm Clear Opening HDPE Channel - Channel 7 Presloped	235mm x 2438mm	311	337	35.8	123
Z882-8208	Z882 235mm Clear Opening HDPE Channel - Channel 8 Presloped	235mm x 2438mm	337	362	36.3	139
Z882-8209	Z882 235mm Clear Opening HDPE Channel - Channel 9 Presloped	235mm x 2438mm	362	387	37.7	155
Z882-8209N	Z882 235mm Clear Opening HDPE Channel - Channel 9 Neutral	235mm x 2438mm	387	387	38.1	-
Z882-8210	Z882 235mm Clear Opening HDPE Channel - Channel 10 Presloped	235mm x 2438mm	387	413	38.6	170
Z882-8211	Z882 235mm Clear Opening HDPE Channel - Channel 11 Presloped	235mm x 2438mm	413	438	39.5	186
Z882-8212	Z882 235mm Clear Opening HDPE Channel - Channel 12 Presloped	235mm x 2438mm	438	464	40.4	202

Z883	DESCRIPTION	DIMENSIONS	C Min. mm	D Max. mm	Weight (approx) Kg	Max. Flow Rate LPS
Z883-CHANNEL	Z883 PP 100mm Clear Opening Shallow Channel	100mm x 1016mm	88.9	88.9	1.8	-

Z880	DESCRIPTION	DIMENSIONS	C Min. mm	D Max. mm	Weight (approx) Kg	Max. Flow Rate LPS
Z880-CHANNEL	Z880 HDPE Pool Drain 1220mm- Gray	640mm x 1220mm	76.2	76.2	1.8	-
Z880-CHANNEL-284-U	Z880 HDPE Pool Drain 1220mm- Blue	640mm x 1220mm	76.2	76.2	1.8	-
Z880-CHANNEL-466-U	Z880 HDPE Pool Drain 1220mm - Sand	640mm x 1220mm	76.2	76.2	1.8	-
90 DEG BENDS						
Z880-C90	Z880 HDPE 90 Degree Pool Drain - Gray	640mm wide	76.2	76.2	-	-
Z880-C90-284-U	Z880 HDPE 90 Degree Pool Drain - Blue	640mm wide	76.2	76.2	-	-
Z880-C90-466-U	Z880 HDPE 90 Degree Pool Drain - Sand	640mm wide	76.2	76.2	-	-
45 DEG BENDS						
Z880-C45	Z880 HDPE 45 Degree Pool Drain - Gray	640mm wide	76.2	76.2	-	-
Z880-C45-284-U	Z880 HDPE 45 Degree Pool Drain - Blue	640mm wide	76.2	76.2	-	-
Z880-C45-466-U	Z880 HDPE 45 Degree Pool Drain - Sand	640mm wide	76.2	76.2	-	-

Z887	DESCRIPTION	Length mm	Width mm	Height mm	Weight (approx) Kg	Max. Flow Rate LPS
Z887-6X20	Z887 100mm Clear Opening Inline Pit	152	508	533	7.7	-
Z887-12X24-NS	Z887 235mm Clear Opening Inline Pit	305	610	610	6.6	-
Z887-24X24	Z887 600mm X 600mm Drainage Pit	591	625	610	9.0	-
Z887-EXT	Z887 HDPE Extension Riser (for Z887-24X24)	600	600	305	10.0	-

Technical Data

Frames, Grates & Accessories Codes

Z886 - FRAMES	DESCRIPTION	DIMENSIONS
P886-HDF	Z886 HD Carbon Steel Frame	100mm x 2032mm
P886-HDGF	Z886 HD Gal. Steel Frame	100mm x 2032mm
P886-HDS	Z886 HD 304 S/Steel Frame	100mm x 2032mm
P886-SVF	Z886/Z883 304 S/Steel Veneer Frame	100mm x 1016mm

*Overall length to allow for overlap 2064mm

Z882 FRAMES	DESCRIPTION	DIMENSIONS
P882-HDF	Z882 HD Carbon Steel Frame	235mm x 2438mm
P882-HDG	Z882 HD Gal. Steel Frame	235mm x 2438mm
P882-HDS	Z882 HD 304 S/Steel Frame	235mm x 2438mm

*Overall length to allow for overlap 2499mm

Z887-FRAMES	DESCRIPTION	DIMENSIONS
P817-HDF-6X20	Z887 HD Carbon Steel Pit Frame (for Z887-6X20)	152mm x 508mm
P817-HDG-6X20	Z887 HD Gal. Steel Pit Frame (for Z887-6X20)	152mm x 508mm
P887-SVF-6X20	Z887 Light Duty 304 S/Steel Veneer Pit Frame (for Z887-6X20)	152mm x 508mm
P817-HDF-12X24	Z887 HD Carbon Steel Pit Frame (for Z887-12X24-NS)	305mm x 610mm
P817-HDG-12X24	Z887 HD Gal. Steel Pit Frame (for Z887-12X24-NS)	305mm x 610mm
P817-HDS-12X24	Z887 HD 304 S/Steel Frame (for Z887-12X24-NS)	305mm x 610mm
P817-HDF-24X24	Z887 HD Carbon Steel Pit Frame	591mm x 625mm
P817-HDG-24X24	Z887 Gal. Steel Frame	591mm x 625mm
P817-HDS-24X24	Z887 304 S/Steel Frame	591mm x 625mm

Z886/Z883 - GRATES	DESCRIPTION	DIMENSIONS	AS3996 Load Class - W/O Frame	AS3996 Load Class - With Frame	Heel Proof	Access & Mobility Compliant AS1428.2	AS3996-2006 3.3.5 Bike safe	AS4586 Compliant Slip Resistant
P6-HPP-DARK-GREY	Z886/Z883 HDPE HeelProof Longitudinal Grate - CLASS A - GREY	137mmX 506mm	A	A	Y	Y	Y	P3
P6-HPP-BLACK	Z886/Z883 HDPE HeelProof Longitudinal Grate - CLASS A - BLACK	137mmX 506mm	A	A	Y	Y	Y	P3
P6-GMG	Z886/Z883 Gal. Steel Mesh Grate - CLASS B	137mm x 1016mm	B	B	N	N	Y	n/a
P6-SMG	Z886/Z883 304 S/Steel Mesh Grate - CLASS B	137mm x 1016mm	B	B	N	N	Y	n/a
P6-DOG	Z886/Z883 DI Ornamental Grate - CLASS B	137mmX 506mm	B	B	Y	Y	Y	n/a
P6-RFGC	Z886/Z883 Gal. Steel Reinforced Slotted Grate - CLASS C/D	137mm x 1016mm	C	D	Y	Y	Y	P3
P6-RFSC	Z886/Z883 304 S/Steel Reinforced Slotted Grate - CLASS C/D	137mm x 1016mm	C	D	Y	Y	Y	P3
P6-DCD	Z886/Z883 DI Circular Decorative Grate - CLASS C	137mmX 508mm	C	C	N	Y	Y	n/a
P6-DTW	Z886/Z883 DI Tidal Wave Decorative Grate - CLASS C/D	137mmX 506mm	C	D	Y	Y	Y	P2
P6-DGE	Z886/Z883 DI Slotted Grate - CLASS C/F	137mmX 506mm	C	F	N	Y	Y	n/a
P6-HPDE-OS	Z886/Z883 DI HeelProof Longitudinal Grate - CLASS C/F	137mmX 506mm	C	F	Y	Y	Y	P3
P6-GHPDE	Z886/Z883 Gal. DI HeelProof Longitudinal Grate - CLASS C/F	137mmX 506mm	C	F	Y	Y	Y	P3
P6-GDE	Z886/Z883 Gal. DI Slotted Grate - CLASS C/F	137mmX 506mm	C	F	N	Y	Y	n/a
P886-FGF	Z886 DI Slotted Frame & Grate - CLASS G	140mmX 507mm	n/a	G	Y	Y	Y	n/a
P6-SSHP-A	Z886/Z883 304 S/Steel HeelProof Grate - CLASS A	137mm x 1016mm	A	A	Y	Y	Y	R10/R10
P6-SSHPPG-A	Z886/Z883 304 S/Steel HeelProof ProGrip Grate - CLASS A	137mm x 1016mm	A	A	Y	Y	Y	R11/R12-P5
P6-SSHP-C	Z886/Z883 304 S/Steel HeelProof Grate - CLASS C	137mm x 1016mm	C	C	Y	Y	Y	R10/R10
P6-SSHPPG-C	Z886/Z883 304 S/Steel HeelProof ProGrip Grate - CLASS C	137mm x 1016mm	C	C	Y	Y	Y	R11/R12-P5
P6-HMSSHP-A	Z886/Z883 304 S/Steel HeelProof Grate - CLASS A - HALF MTR	137mmX 508mm	A	A	Y	Y	Y	R10/R10
P6-HMSSHPPG-A	Z886/Z883 304 S/Steel HeelProof ProGrip Grate - CLASS A - HALF MTR	137mmX 508mm	A	A	Y	Y	Y	R11/R12-P5
P6-HMSSHP-C	Z886/Z883 304 S/Steel HeelProof Grate - CLASS C - HALF MTR	137mmX 508mm	C	C	Y	Y	Y	R10/R10
P6-HMSSHPPG-C	Z886/Z883 304 S/Steel HeelProof ProGrip Grate - CLASS C - HALF MTR	137mmX 508mm	C	C	Y	Y	Y	R11/R12-P5
P886-PVSG	Z886/Z883 Gal. Steel Paver Slot Grate - CLASS C	137mm x 1016mm	C	n/a	N	Y	Y	n/a
P886-PVSS	Z886/Z883 304 S/Steel Paver Slot Grate - CLASS C	137mm x 1016mm	C	n/a	N	Y	Y	n/a

Z882-GRATES	DESCRIPTION	DIMENSIONS	AS3996 Load Class - W/O Frame	AS3996 Load Class - With Frame	Heel Proof	Access & Mobility Compliant AS1428.2	AS3996-2006 3.3.5 Bike safe	AS4586 Compliant Slip Resistant
P12-GG	Z882 Vinyloster Fibreglass Ladder Grate - CLASS A	289mm x 610mm	-	A	N	N	Y	P4
P12-BG-L	Z882 Gal. Steel Light Duty Bar Grate - CLASS B	286mm x 610mm	-	B	N	N	Y	n/a
P12-SBG-L	Z882 304 S/Steel Bar Grate - CLASS D	286mm x 610mm	-	D	N	N	Y	n/a
P12-RFGC	Z882 Gal. Steel Reinforced Slotted Grate - CLASS D	289mm x 610mm	-	D	Y	Y	Y	P3
P12-RFSC	Z882 304 S/Steel Reinforced Slotted Grate - CLASS D	289mm x 610mm	-	D	Y	Y	Y	n/a
P12-HPD	Z882 DI HeelProof Longitudinal Grate - CLASS B	285mm x 610mm	-	B	Y	Y	Y	n/a
P12-HPDE	Z882 DI HeelProof Longitudinal Grate - CLASS F	285mm x 610mm	-	F	Y	Y	Y	P3
P12-GHPDE	Z882 Gal. DI HeelProof Longitudinal Grate - CLASS F	285mm x 610mm	-	F	Y	Y	Y	P3
P12-DGE	Z882 DI Slotted Grate - CLASS F	286mm x 610mm	-	F	N	Y	Y	n/a
P12-SSHP-A	Z882 304 S/Steel HeelProof Grate - CLASS A	289mm x 1220mm	-	A	Y	Y	Y	R10/R10
P12-SSHPPG-A	Z882 304 S/Steel HeelProof ProGrip Grate - CLASS A	289mm x 1220mm	-	A	Y	Y	Y	R11/R12-P5
P12-SSHP-C	Z882 304 S/Steel HeelProof Grate - CLASS C	289mm x 1220mm	-	C	Y	Y	Y	R10/R10
P12-SSHPPG-C	Z882 304 S/Steel HeelProof ProGrip Grate - CLASS C	289mm x 1220mm	-	C	Y	Y	Y	R11/R12-P5
P12-HMSSHP-A	Z882 304 S/Steel HeelProof Grate - CLASS A - HALF MTR	289mm x 610mm	-	A	Y	Y	Y	R10/R10
P12-HMSSHPPG-A	Z882 304 S/Steel HeelProof ProGrip Grate - CLASS A - HALF MTR	289mm x 610mm	-	A	Y	Y	Y	R11/R12-P5
P12-HMSSHP-C	Z882 304 S/Steel HeelProof Grate - CLASS C - HALF MTR	289mm x 610mm	-	C	Y	Y	Y	R10/R10
P12-HMSSHPPG-C	Z882 304 S/Steel HeelProof ProGrip Grate - CLASS C - HALF MTR	289mm x 610mm	-	C	Y	Y	Y	R11/R12-P5

Z880 GRATES	DESCRIPTION	DIMENSIONS	AS3996 Load Class - W/O Frame	AS3996 Load Class - With Frame	Heel Proof	Access & Mobility Compliant AS1428.2	AS3996-2006 Bike safe	AS4586 Compliant Slip Resistant
PLAIN 610mm GRATES								
P880-POG	Z880 PE Pool Grate - Gray	61mm x 610mm	A	n/a	Y	Y	Y	n/a
P880-POG-284-U	Z880 PE Pool Grate - Blue	61mm x 610mm	A	n/a	Y	Y	Y	n/a
P880-POG-466-U	Z880 PE Pool Grate - Sand	61mm x 610mm	A	n/a	Y	Y	Y	n/a
P880-SSHP	Z880 S/Steel Wire Pool Grate	61mm x 610mm	A	n/a	Y	Y	Y	n/a
P880-SSHPPG	Z880 S/Steel HeelProof Wire Pool Grate	61mm x 610mm	A	n/a	Y	Y	Y	n/a
90 DEG GRATES								
P880-G90	Z880 PE 90 Degree Bend Pool Grate - Gray	61mm wide	A	n/a	Y	Y	Y	n/a
P880-G90-284-U	Z880 PE 90 Degree Bend Pool Grate - Blue	61mm wide	A	n/a	Y	Y	Y	n/a
P880-G90-466-U	Z880 PE 90 Degree Bend Pool Grate - Sand	61mm wide	A	n/a	Y	Y	Y	n/a
45 DEG GRATES								
P880-G45	Z880 PE 45 Degree Bend Pool Grate - Gray	61mm wide	A	n/a	Y	Y	Y	n/a
P880-G45-284-U	Z880 PE 45 Degree Bend Pool Grate - Blue	61mm wide	A	n/a	Y	Y	Y	n/a
P880-G45-466-U	Z880 PE 45 Degree Bend Pool Grate - Sand	61mm wide	A	n/a	Y	Y	Y	n/a

Z887-GRATES	DESCRIPTION	DIMENSIONS	AS3996 Load Class - W/O Frame	AS3996 Load Class - With Frame	Heel Proof	Access & Mobility Compliant AS1428.2	AS3996-2006 Bike safe	AS4586 Compliant Slip Resistant
P817-GG-24X24	Z887 Vinylester Fibreglass Ladder Grate - CLASS A	572mm x 610mm	A	A	N	N	Y	P4
P817-DGC-24X24	Z887 DI Slotted Grate - CLASS C/D	572mm x 610mm	C	D	N	Y	Y	n/a
P817-BG-L-24X24	Z887 Gal. Steel Bar Grate CLASS A	572mm x 610mm	A	A	N	N	Y	n/a
P817-BG-M-24X24	Z887 Gal. Steel Bar Grate CLASS C	572mm x 610mm	C	C	N	N	Y	n/a
P817-DGF-24X24	Z887 DI Slotted Grate - CLASS C/G	572mm x 610mm	C	F	N	Y	Y	n/a
P817-SSHP-A-304-24	Z887 304 S/Steel HeelProof Grate - CLASS A	572mm x 610mm	A	A	Y	Y	Y	R10/R10
P817-SSHPPG-A-304-24	Z887 304 S/Steel HeelProof ProGrip Grate - CLASS A	572mm x 610mm	A	A	Y	Y	Y	R11/R12-P5
P817-SSHP-C-304-24	Z887 304 S/Steel HeelProof Grate - CLASS C	572mm x 610mm	C	C	Y	Y	Y	R10/R10
P817-SSHPPG-C-304-24	Z887 304 S/Steel HeelProof ProGrip Grate - CLASS C	572mm x 610mm	C	C	Y	Y	Y	R11/R12-P5

Z886 ACCESSORIES	DESCRIPTION
P886-E1-NS	Z886 HDPE Closed End Cap
P886-U4-NS-AUS	Z886 HDPE 100mm Adapted Bottom Outlet
P886-U6-NS-AUS	Z886 HDPE 150mm Adapted Bottom Outlet
P886-JC-NS	Z886 HDPE Joint Connector
LOCKDOWNS	
669558499	Z886/Z883 304 S/Steel Grate Lockdown - No Frame
669558409	Z886/Z883 Standard Grate Lockdown Bags - No Frame
669558489	Z886/Z883 P886-HD Assembly Grate Lockdown
669559539	Z886/Z883 P6-SSHP (All) Fab. Grate Lockdown w/SS Bar - PKT (4)
66955880F	Z886/Z883 P6-GMG Grate Lockdown
669558879	Z886/Z883 P6-RFGC Grate Lockdown
669558439	Z886/Z883 Vandal Proof Grate Lockdown
END COVERS	
669558579	Z886 P886-HDF HD End Covers
669558649	Z886 P886-HDGF Gal. End Covers
669558659	Z886 P886-HDS S/Steel End Covers
669559439	Z886/Z883 P886-SVF End Covers
ASSEMBLY SCREWS	
669558419	Z886 Overlap Connection (Connects Male-Female)
669558429	Rebar Clip Screws (Rebar-Trench) ALL
669558469	Z886 P886-HDF HD Frame Assembly Screws
669558479	Z886/Z883 P886-SVF Frame assembly screws

Z883-ACCESSORIES	DESCRIPTION
P883-E1-NS	Z883 PP Closed End Cap
P883-U4-NS-AUS	Z883 PP 100mm Adapted Bottom Outlet
LOCKDOWNS	
669558499	Z886/Z883 304 S/Steel Grate Lockdown - No Frame
669558409	Z886/Z883 Standard Grate Lockdown Bags - No Frame
669558489	Z886/Z883 P886-HD Assembly Grate Lockdown
669559539	Z886/Z883 P6-SSHP (All) Fab. Grate Lockdown w/SS Bar - PKT (4)
66955880F	Z886/Z883 P6-GMG Grate Lockdown
669558879	Z886/Z883 P6-RFGC Grate Lockdown
669558439	Z886/Z883 Vandal Proof Grate Lockdown
END COVERS	
669559439	Z886/Z883 P886-SVF End Covers
ASSEMBLY SCREWS	
669558429	Rebar Clip Screws (Rebar-Trench) ALL
669558599	Z883 CONNECTION BAG Male-Female
669558479	Z886/Z883 P886-SVF Frame assembly screws

Z882 ACCESSORIES	DESCRIPTION
OUTLETS/END CAPS	
P882-E1-NS	Z882 HDPE Closed End Cap
P882-U6-NS-AUS	Z882 HDPE 150mm Adapted Bottom Outlet
P882-U8-NS-AUS	Z882 HDPE 225mm Adapted Bottom Outlet
P882-JC-NS	Z882 HDPE Joint Connector
LOCKDOWNS	
669559239	Z882 Standard Grate Lockdown
669558189	Z882 P12-HPD Grate Lockdown Bag (4 Grates)
669558779	Z882 P12-GG Fibreglass Grate Lockdown
669559279	Z882 P12-SSHP (All) Fab. Grate Lockdown
END COVERS	
669558349	Z882 P882-HDF HD End Covers
669558509	Z882 P882-HDG Gal. End Covers
669558519	Z882 P882-HDS S/Steel End Covers
ASSEMBLY SCREWS	
669558429	Rebar Clip Screws (Rebar-Trench) ALL
669558759	Z882 Connection Screws (Male-Female)
669558-FRM-SCR-KIT	Z882 Assembly Screw & Nuts Bag (X10) (Frame-Trench)

Z880 ACCESSORIES	DESCRIPTION
BOTTOM OUTLETS	
P880-U150	Z880 38mm No Hub Bottom Outlet - Gray
P880-U150-284-U	Z880 38mm No Hub Bottom Outlet - Blue
P880-U150-466-U	Z880 38mm No Hub Bottom Outlet - Sand
END CAPS	
P880-E1	Z880 End Cap - Gray
P880-E1-284-U	Z880 End Cap - Blue
P880-E1-466-U	Z880 End Cap - Sand
END OUTLET	
P880-E150	Z880 38mm End Outlet - Gray
P880-E150-284-U	Z880 38mm End Outlet - Blue
P880-E150-466-U	Z880 38mm End Outlet - Sand

Z887-ACCESSORIES	DESCRIPTION
P887-INLET-6-NS	Z886/Z887 HDPE Inlet Adapter (Z886 Adapter-Z887 Pit)
P887-INLET-12-NS	Z882/Z887 HDPE Inlet Adapter (Z882 Adapter-Z887 Pit)
P887-CB-Y-6X20	Z887 Sediment Basket (for Z887-6X20)
P887-CB-Y-12X24	Z887 Sediment Basket (for Z887-12X24-NS)
P887-24X24-NS	Z887 Sediment Basket (for Z887-24X24 Pit)



LWG ZURN AUSTRALIA P/L
ABN: 12 164 922 758



HEAD OFFICE

VICTORIA :
49 Lakeside Drive,
Broadmeadows, Vic 3047
Phone: +61 3 8301 9499
Fax: +61 3 9357 1455
Email: vic@lwgzurn.com

QUEENSLAND:
Unit 2 - 6 Trade Street
Lytton, QLD 4178
Phone: +61 7 3348 2666
Fax: +61 7 3396 7066
Email: qld@lwgzurn.com

NEW SOUTH WALES:
Unit 6, 3-11 Hallmark Street
Pendle Hill, NSW 2145
Phone: +61 2 9631 2549
Fax: +61 2 9631 2065
Email: nsw@lwgzurn.com

SOUTH AUSTRALIA:
3 River Street
Hindmarsh, SA 5007
Phone: +61 8 8340 9999
Fax: +61 8 8340 9000
Email: sa@lwgzurn.com

WESTERN AUSTRALIA:
398 Victoria Road
Malaga, WA 6090
Phone: +61 8 9203 1400
Fax: +61 08 9249 8922
Email: wa@lwgzurn.com

NORTHERN TERRITORY:
Unit 4, 10 Witte Street
Winnellie, NT 0820
Phone: +61 437 702 253
Fax: +61 8 8947 0036
Email: ross@lwgzurn.com