

GET IN TOUCH: 1300 240 298

Detail Rampe

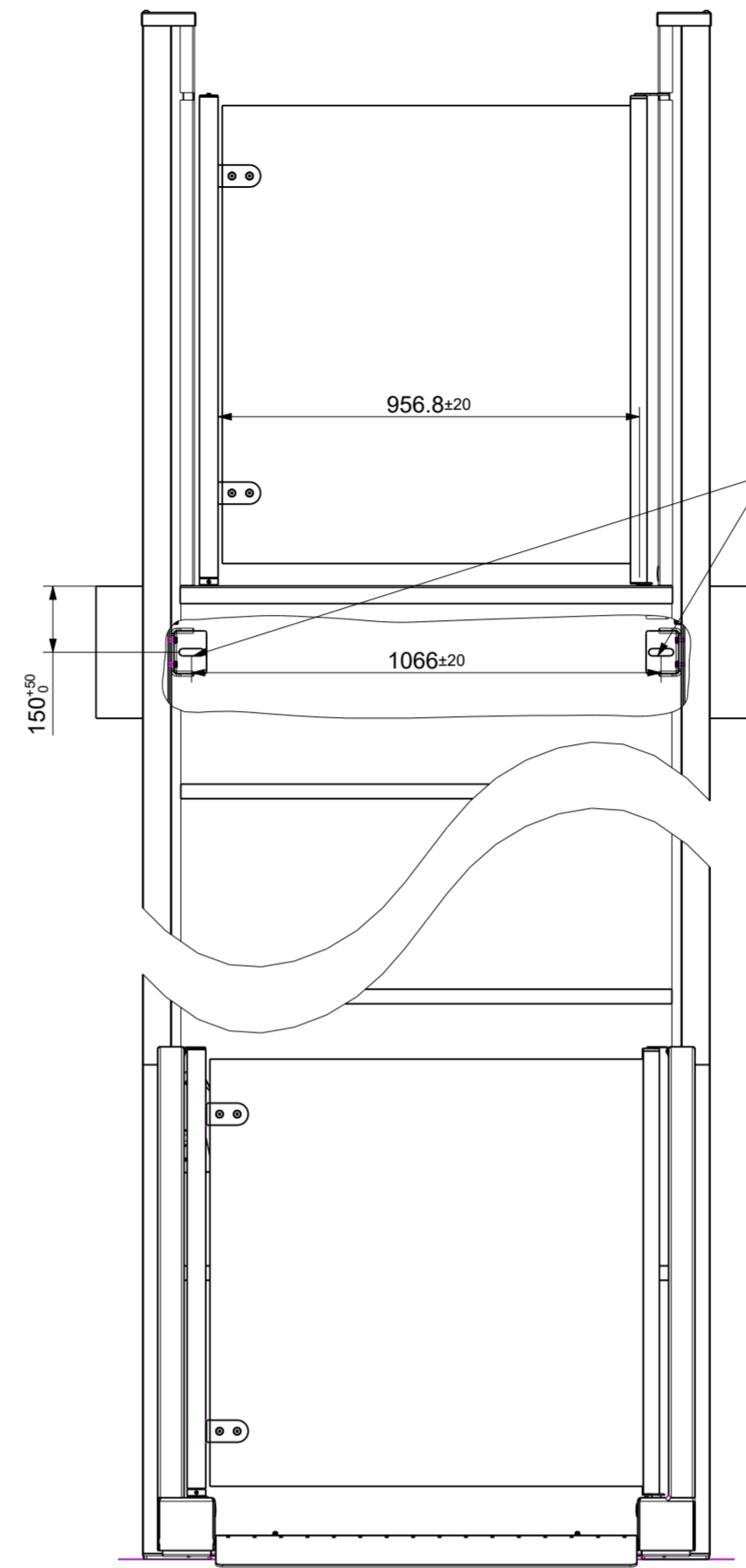

2x Befestigungspunkte

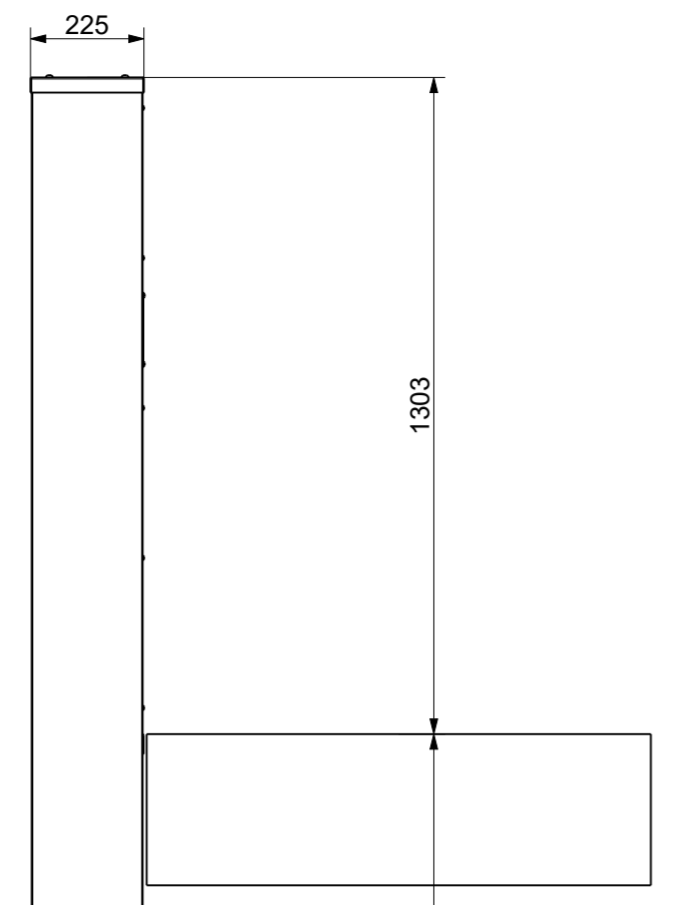
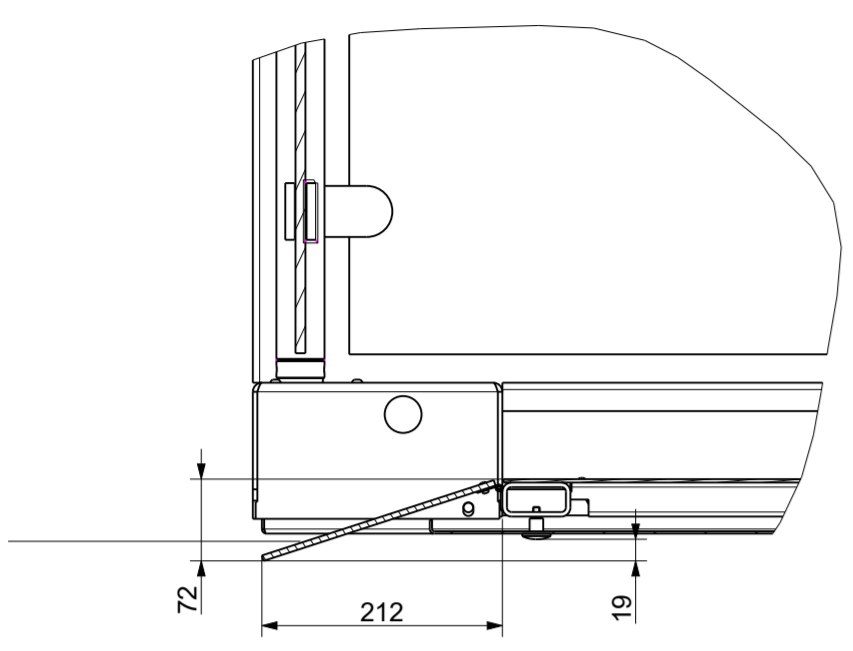
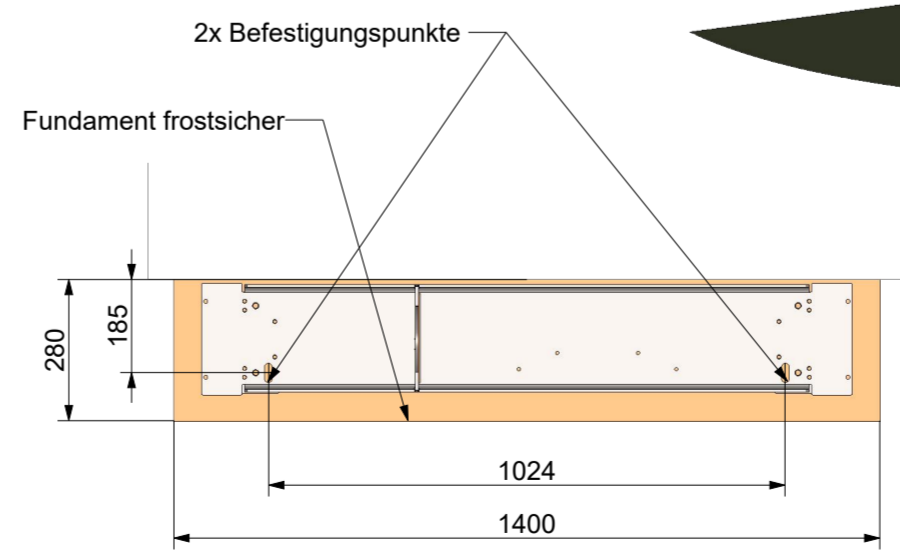
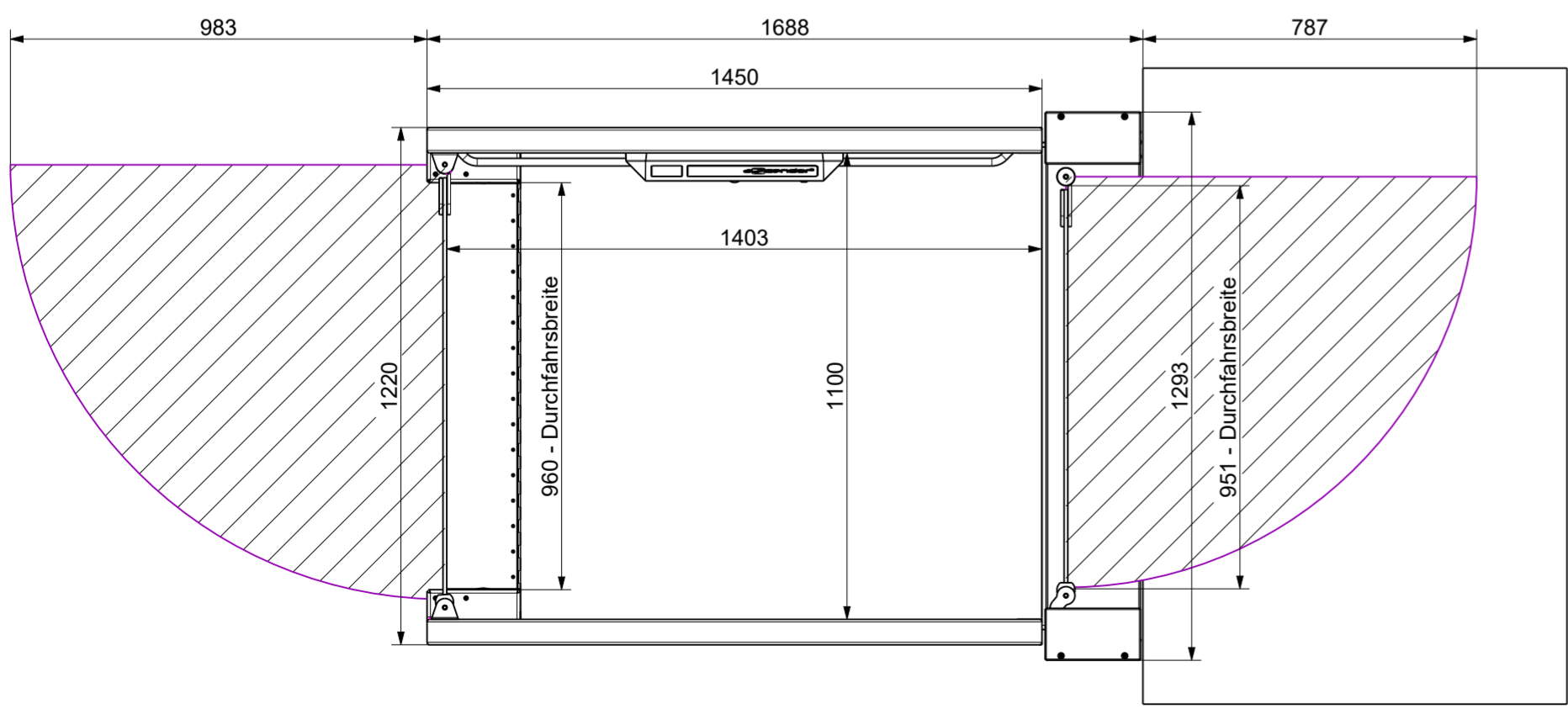
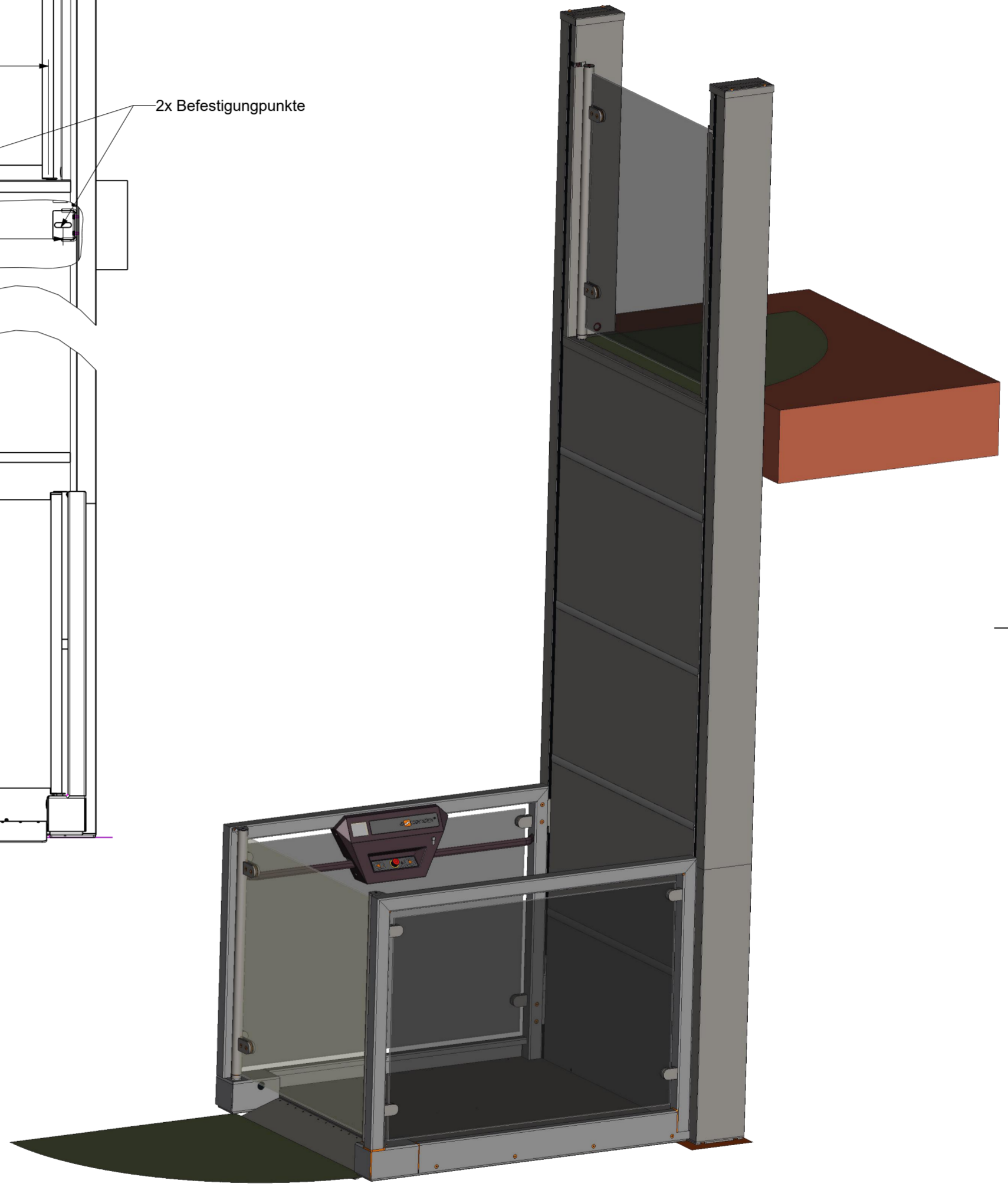
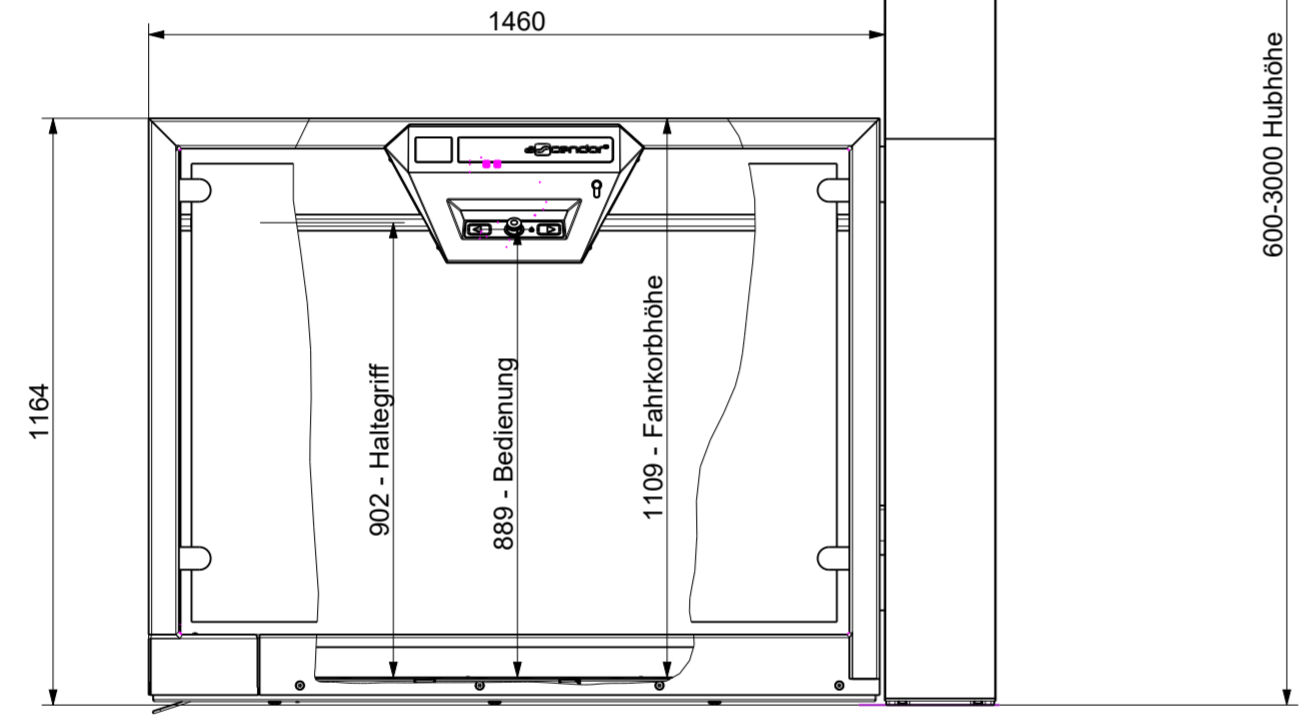

		Datum	Name
	Bear.	19.11.2020	Schönberger
	Gepr.		
	Norm		
A	21.04.2021	DS	
Zust.	Datum		