

- D:** Ganz schön kreativ, was Sie mit **Jakob® INOX LINE 5.1** gestalten können. In unserem 116-seitigen Hauptkatalog finden Sie die Lösung.
- F:** A peine croyable, tout ce que vous pouvez réaliser avec le catalogue **Jakob® INOX LINE 5.1**. Sur les 116 pages de notre catalogue général, vous trouverez la solution appropriée.
- E:** You can be so creative with **Jakob® INOX LINE 5.1** and you'll find all the inspiration you need in our 116-page main catalogue.
- I:** Nessun limite alla vostra creatività, grazie a **Jakob® INOX LINE 5.1**. Le 116 pagine del nostro catalogo generale vi presentano allettanti proposte.

- D:** Neuheiten und sinnvolle Ergänzungen: Bestellen Sie den 68-seitigen **NEWS-Katalog** von **Jakob® INOX LINE**.
- F:** Nouveautés et suppléments judicieux sur 68 pages: commandez le catalogue **NEWS** de **Jakob® INOX LINE**.
- E:** New products and useful additions: Please order the 68-page **NEWS** catalogue from **Jakob® INOX LINE**.
- I:** 68 pagine di novità e significativi integrazioni: ordinate ancora oggi il catalogo **NEWS** di **Jakob® INOX LINE**.

Ihr **Jakob® INOX LINE** - Partner
Votre partenaire **Jakob® INOX LINE**
Your **Jakob® INOX LINE** Distributor
Il vostro interlocutore **Jakob® INOX LINE**

In über 50 Ländern sind wir für Sie da:
Nous sommes à votre disposition dans plus de 50 pays:
Siamo presenti in oltre 50 paesi:
Worldwide presence in over 50 countries:

Europe

• Austria • Belgium • Bulgaria • Croatia • Cyprus • Czech Republic • Denmark
• Finland • France • Germany • Greece • Hungary • Ireland • Italy • Latvia • Lithuania
• Macedonia • Netherlands • Norway • Poland • Portugal • Romania • Russia • Slovakia
• Slovenia • Spain • Sweden • Switzerland • Turkey • United Kingdom • Yugoslavia

India and Asia

• Brunei • India • Indonesia • Korea • Malaysia • Philippines • Singapore • Thailand

Far East • China • Hong Kong • Japan • Taiwan

Australia and New Zealand • Australia • New Zealand

North America • Canada • USA

South America • Argentina • Brazil • Colombia • Uruguay

Mediterranean and Africa

• Dubai/UAE • Egypt • Israel • Jordan • Lebanon • Morocco • South Africa

Für alle übrigen Informationen wenden Sie sich bitte an:
Pour de plus amples renseignements, veuillez s.v.p. contacter:
For any other information please contact:
Per qualsiasi informazione, vogliate rivolgervi a:

Jakob AG, Drahtseilfabrik, CH-3555 Trubschachen, Switzerland
Tel. +41 34 495 10 10, Fax +41 34 495 10 25
www.jakob.ch, eMail: inox@jakob.ch

Katalogbestellungen unter:
Commandez votre catalogue sous:
Order your catalogue under:
Per richiedere il catalogo basta accedere a:

www.jakob.ch

October 2003. Printed in Switzerland.
© Copyright by Jakob AG Switzerland 1988 / 2003 Rev.1
Idea & Conception by Atelier Jakob AG, CH-1783 Barberêche

Jakob® INOX LINE

... rostfreie Drahtseile
und Endverbindungen
mit den unendlichen
Kombinationsmöglichkeiten.

... câbles et éléments inox
pour une gamme d'utilisations
illimitées.

... stainless steel wire rope
products and connectors
for an unlimited range
of applications.

... funi di acciaio inossidabile
e terminali che consentono
un'innumerabile varietà di
combinazioni.



Jakob® INOX LINE

Green façades for a pleasant atmosphere.

Façade greening, so far usually left to chance,

has gained a new dimension: Jakob[®] INOX LINE.

Attractive training systems for microgardens

can be built with a few easy-to-assemble com-

ponents made of high-grade stainless steel.

The days of haunted castles are over:

Green façades are appealing, ecologically

sensible and useful. The latest insights on

climbing plants combined with tastefully

designed and technically sophisticated train-

ing systems open a treasure chest of greening

variations and styles. Greening makes sense

from a construction physics point of view and

has many ecological benefits. The future is

indeed green: it will be shaped by the creative

collaboration of innovation-driven architects

with greening specialists.

© Copyright by
Jakob AG, Drahtseilfabrik
CH-3555 Trubschachen
Switzerland 1988 / 2003 Rev.1

Technical data subject to change.

© Copyright by
Atelier Jakob AG/SA, Switzerland

Idea / Conception
Atelier Jakob AG/SA, Hannes Jakob SGD
CH-1783 Barberêche, Switzerland

Horticultural Consultant
Fritz Wassmann, Switzerland



06	07	GOOD REASONS FOR GREENING
08	11	CLIMBING PATTERNS / TRAINING SYSTEMS
12	17	CLIMBERS AT A GLANCE
18	23	HOW TO PLAN TRAINING SYSTEMS
24	37	GREENGUIDE ROPE STYLES F1 - F6
38	43	COMPONENT COMBINATIONS
44	45	ROPE / EXTERNAL THREADS
46	47	END STOP / EYES / LOOPS
48	51	SPACERS / WEBNET
52	53	CROSS CLAMPS
54	55	ROD SYSTEM
56	57	TRELLISWORK
58	59	COLUMN GREENING
60	63	WOODEN ROD SYSTEM
64	65	SECTIONS / ASSEMBLY AIDS
66	67	DOCUMENTATIONS JAKOB



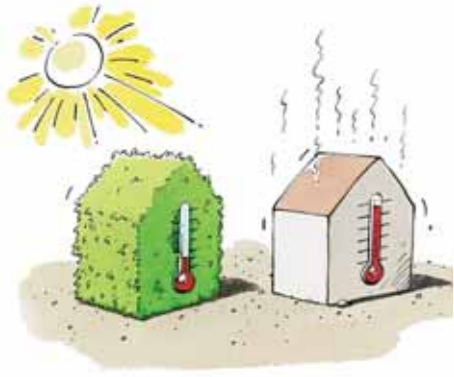

INTERIOR TEMPERATURE REGULATION

The familiar pergola of southern countries is an ancient but highly efficient method of interior temperature regulation. It promotes the formation of an insulating layer of air, thereby preventing an excessive increase of the inside temperature due to direct solar irradiation. This principle also offers several advantages when applied to vertical structures: the insulating cushion of air between vegetation and façade evens out temperature fluctuations and noticeably reduces heating and air-conditioning costs.

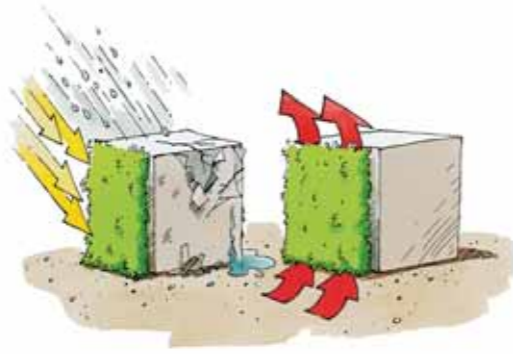

FAÇADE PROTECTION AND VENTILATION

A well-designed covering of vegetation is a natural shield against lashing rain or ultraviolet radiation. In addition, the space between the façade and the greenery has a temperature-regulating effect and promotes optimum ventilation as well.



THE AESTHETICS OF GREENING

The integration of greened surfaces into contemporary architecture presents novel design opportunities. Planners and architects who have teamed up with greening specialists are already producing outstanding results and are defining new dimensions for "art on buildings."

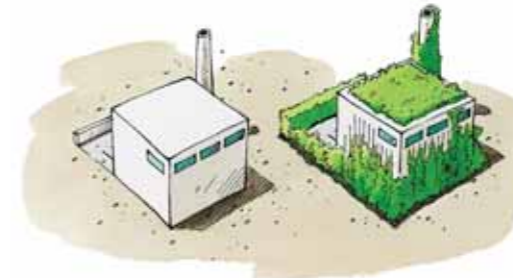

REVALUATION OF EXISTING STRUCTURES

Without any risk whatsoever, professionally conceived façade-greening schemes can aesthetically upgrade bleak storage buildings or non-descript concrete apartment blocks. Beneficial side effects include natural air-conditioning, reduction in energy costs and an extension of the useful life of the structure.



COMPLEMENTARY GREENED SURFACES IN URBAN ENVIRONMENTS

A large number of buildings in conurbations offer locations where plants can be grown. Ever-increasing land prices necessitate the erection of high-rise structures. The subminiature gardens on housing estates or balconies benefit materially – the greening of buildings is economical, ecologically favourable and, at the same time, enhance the quality of life.

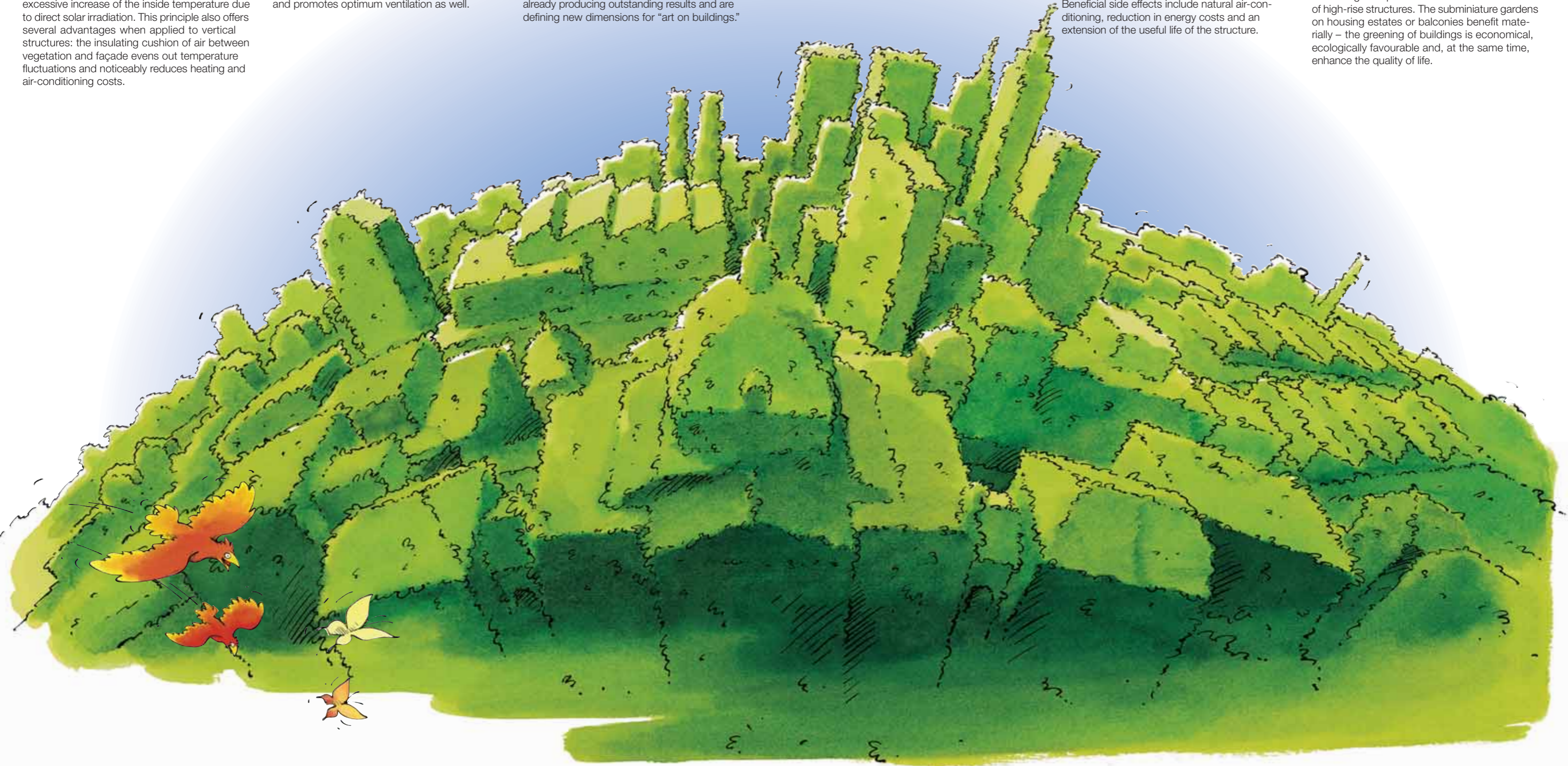

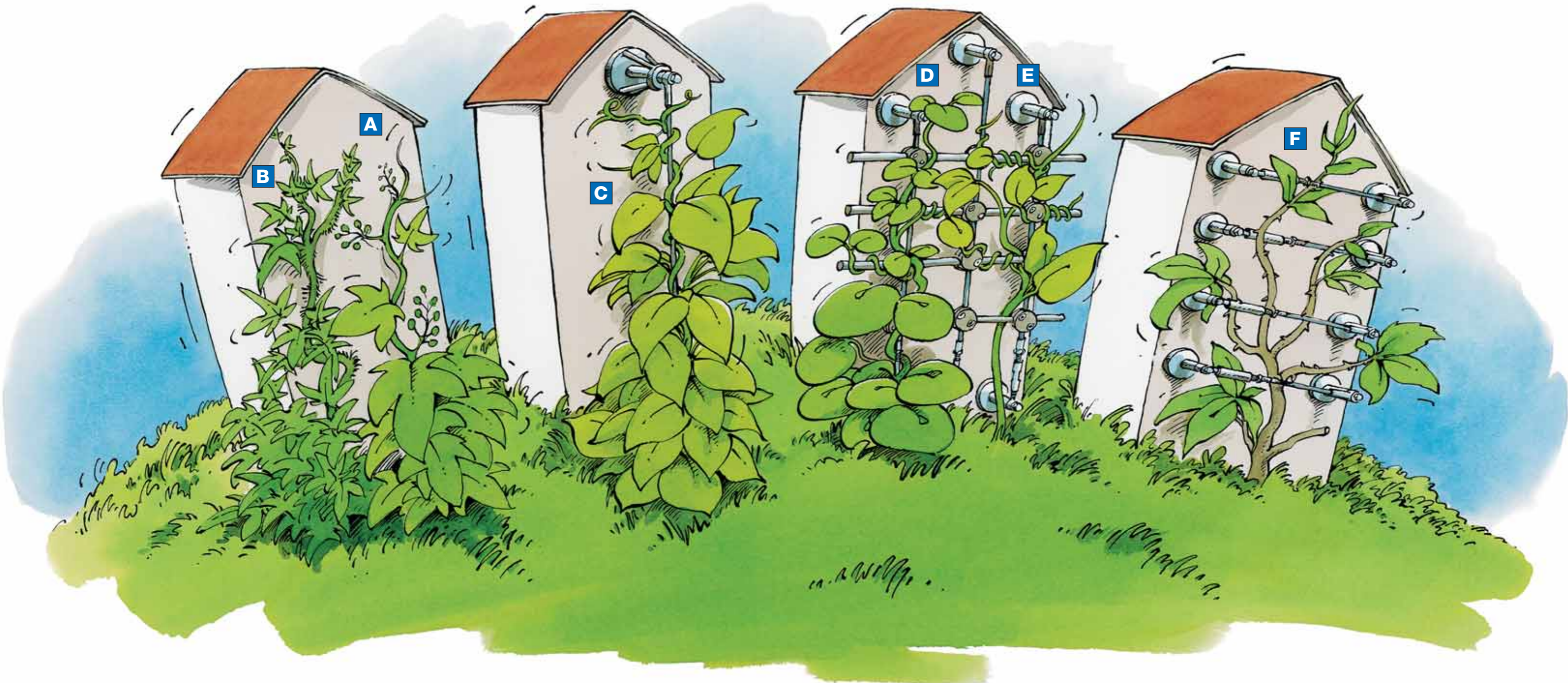

A ADHESIVE-SUCKER CLIMBER

B ROOT CLIMBERS

C VINES (TWINING PLANTS)

D LEAF-STEM CLIMBERS

E LEAF CLIMBERS

F SCRAMBLING PLANTS

Characteristics and requirements of climbers

The natural habitats of the climbing plants are for the most part in woodland and forests, clearings and peripheral zones. Supported by other plants, they work their way upwards to the light (several species thrive and support themselves on rocks). **The climbing plants have developed a variety of climbing patterns (A to F).**

Growing conditions as near as possible to those in natural habitats must be provided to ensure the successful covering of façades – moist, humus-rich and loose-packed soil together with a support structure appropriate to any of the climbing patterns. Generally speaking, good supplies of water and nutrients are important. An additional water supply may be imperative to ensure healthy growth.

The correct training system must be selected for each specific climber.

With regard to optimising the planting location, there can be divergences from the typical biogenic habitat such as a shady root-run and sunlight for the top of the plant.

- Wisteria, trumpet vine (Campsis) as well as several Clematis varieties require unobstructed sunlight to encourage free flowering.
- Ivies (Hedera), many honeysuckle (Lonicera) and Clematis varieties do best in lightly shaded locations.

08.1



09.1 09.2



09.3



Adhesive-sucker climbers support themselves with short lateral shoots tipped with glandular discs that adhere to any surface, even those that are quite smooth. Although these plants require **no auxiliary means of support**, they can cause damage to buildings.

- Boston ivy (Parthenocissus tricuspidata)

Adventitious root climbers require **no auxiliary means of support**. They attach themselves firmly to rocks, tree trunks or façades. These climbers, too, can cause damage to buildings.

- Ivy
- Climbing hydrangea
- Trumpet vine (Campsis)
- Euonymus fortunei

Vines twine around their supports as a result of the circular movement of their stem tips (circumnutation). Only a single vertical support (wire rope) is required.

- Wisteria, honeysuckle (Lonicera)
- Staff tree (Celastrus)
- Hops (Humulus)
- Morning glory (Ipomoea)

Leaf-stem climbers form coils around their supports with their leaf stems. Grid-like or reticular structures provide the best supports.

- Clematis (most varieties)
- Nasturtiums (Tropaeolum)

Leaf climbers develop clinging, often beautiful structures that respond to external stimuli. Grid-like or reticular structures provide optimum supports.

- Grape vines (Vitis)
- Ampelopsis
- Passion flowers (Passiflora)
- Cucumeraceae

Scrambling plants work their way up by using epidermal outgrowths such as prickles, hook-like thorns and bristles.

- Climbing and rambler roses
- Bramble-like shrubs (Rubus)
- Winter-flowering jasmine

A ADHESIVE-SUCKER CLIMBER

B ROOT CLIMBERS

C VINES (TWINING PLANTS)

D LEAF-STEM CLIMBERS

E LEAF CLIMBERS

F SCRAMBLING PLANTS

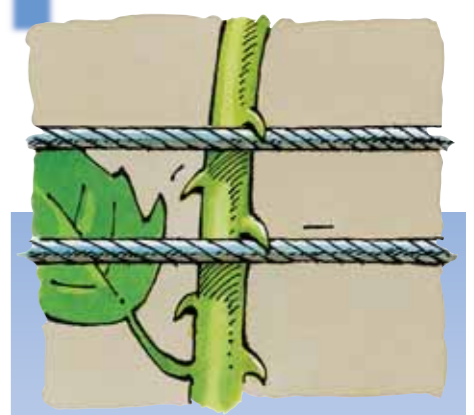
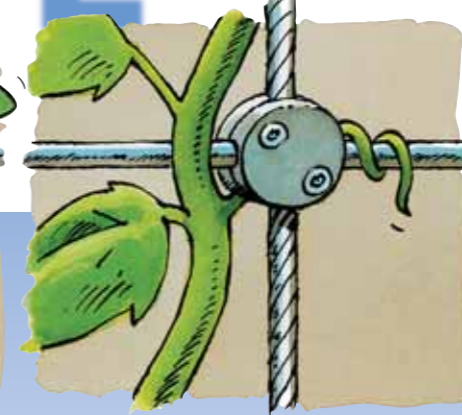
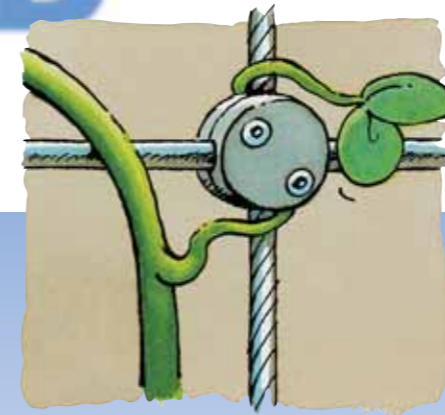
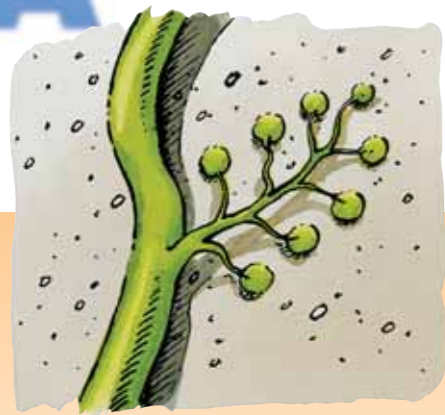

STRUCTURAL DAMAGE AND INSECTS

Climbing plants do not bore holes or cause cracks in the masonry. This is why most of them are harmless. Nevertheless, exceptions and potential hazards should not be disregarded. Certain climbers (e.g. the ivies) can grow into joints and cracks, widening them, and thereby causing permanent damage. Collaboration with greening specialists helps to avoid such risks and to optimise the many benefits that result from greening a building.

Greened façades replace the natural greenery that has become rare in urban environments and, at the same time, offer a new biosphere for animal life. Insects are more likely to be beneficial than harmful. They are essential for the pollination of numerous cultivated plants and also act as public health officers while serving as a basic food supply for other creatures. Regular inspections and trimming where it is necessary help to prevent damage and an invasion by unwelcome guests.

ROPE SPACING FOR VINES



for slow-growing to moderately vigorous climbers (e.g. Lonicera) approx. **200 - 400**

for very vigorous climbers (e.g. Wisteria) approx. **400 - 800**

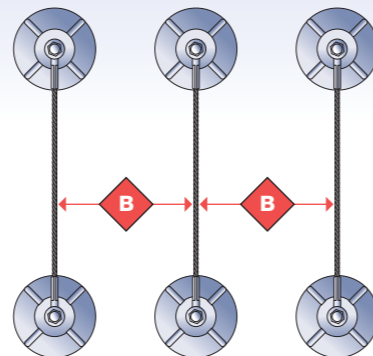

LATTICE SIZES



for slow-growing to moderately vigorous climbers (e.g. Clematis) approx. **150 x 250**

for very vigorous climbers (e.g. Vitis) approx. **300 x 500**

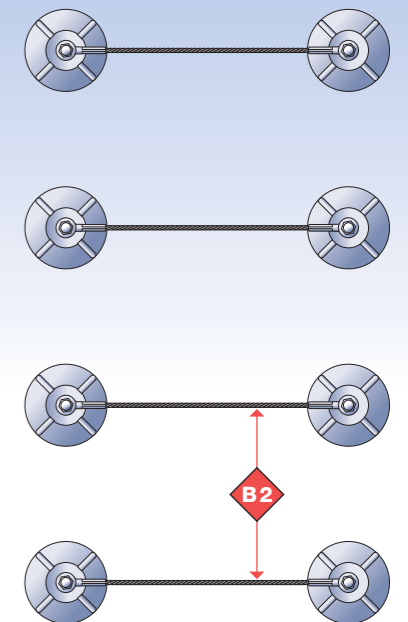
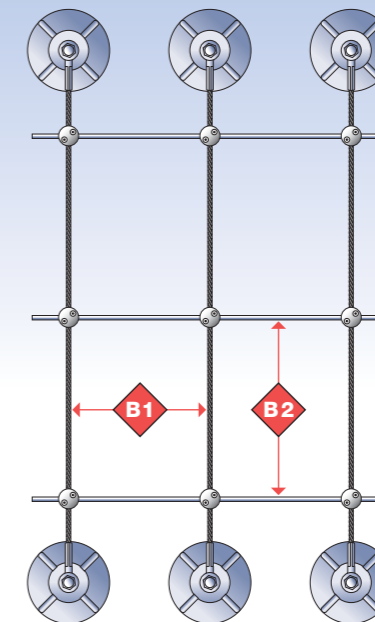

CDEF

DIMENSIONS

- The ideal height and width of the climber supports
- distances from wall
- wire rope spacing for vines
- lattice size
- wire rope or rod diameters

depend on the vigour, size and climbing pattern of the desired climber as well as on the architecture of the structure and the aesthetics of the greening concept.

DISTANCES FROM WALL



for slow-growing to moderately vigorous climbers (e.g. Clematis, Lonicera) approx. **80**

for very vigorous climbers (e.g. Wisteria, Celastrus, Fallopia) approx. **150**

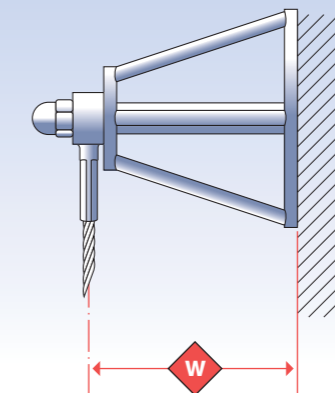

Plants with different climbing patterns can be combined perfectly well. The plants themselves as well as the configurational and aesthetic aspects determine the choice of the climbing supports. Any desired configuration can be created with the **Jakob®INOX LINE**.

Qualified greening specialists should be consulted when the plants are chosen.

The rope and rod diameters of the **Jakob®INOX LINE** can be used for all climbing and espaliered plants. **Jakob®INOX LINE** combines the practicability and aesthetic attributes with versatility, stability and durability.

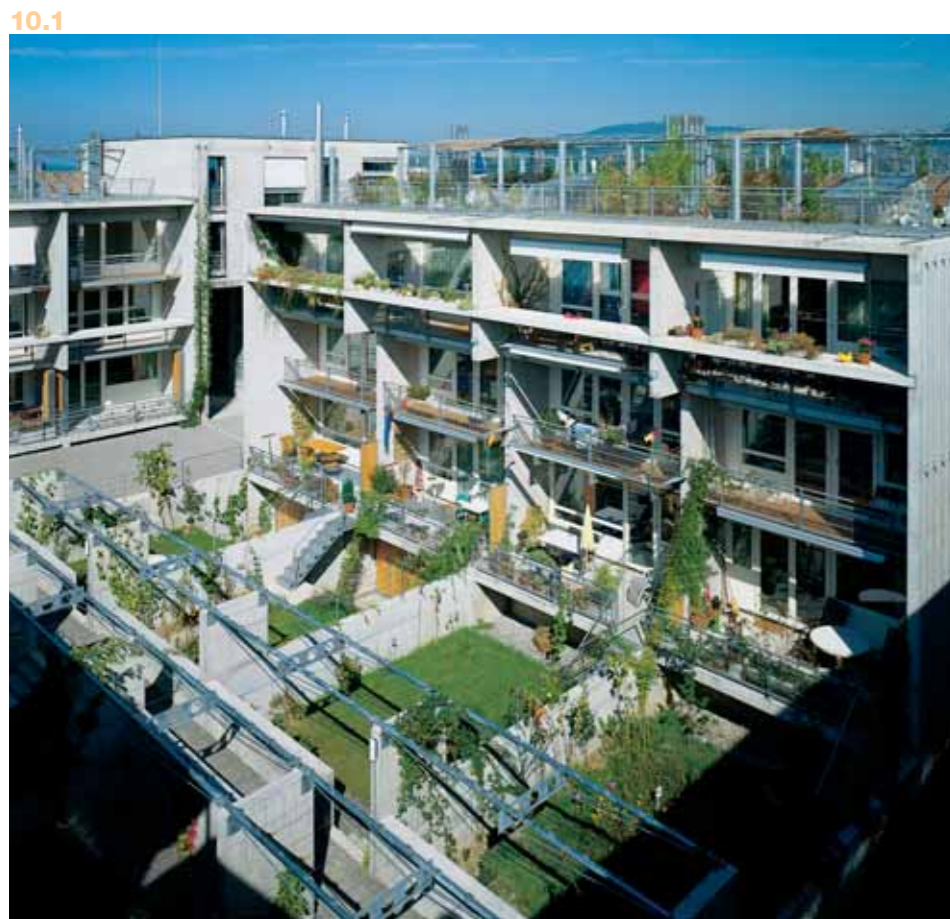

12.1-12.3



BUILDING GREENING IN THE WORLD'S VEGETATION AND CLIMATE ZONES

The greening of buildings meets all the requirements for consideration as an important element in contemporary housing-estate planning.

Main advantage

Occupies very little ground space but nevertheless has many uses.

Example: energy saving

Large amounts of energy and considerable sums of money can be saved by greening buildings with climbing plants, particularly in climatic zones where inner rooms are cooled at certain times (e.g. in the Mediterranean countries, Southern USA, Japan, Australia, etc.).

Example: well-being

Improved ambient conditions, a better quality of life, easing the ecological burden – all these benefits are readily attainable by covering buildings with greenery.

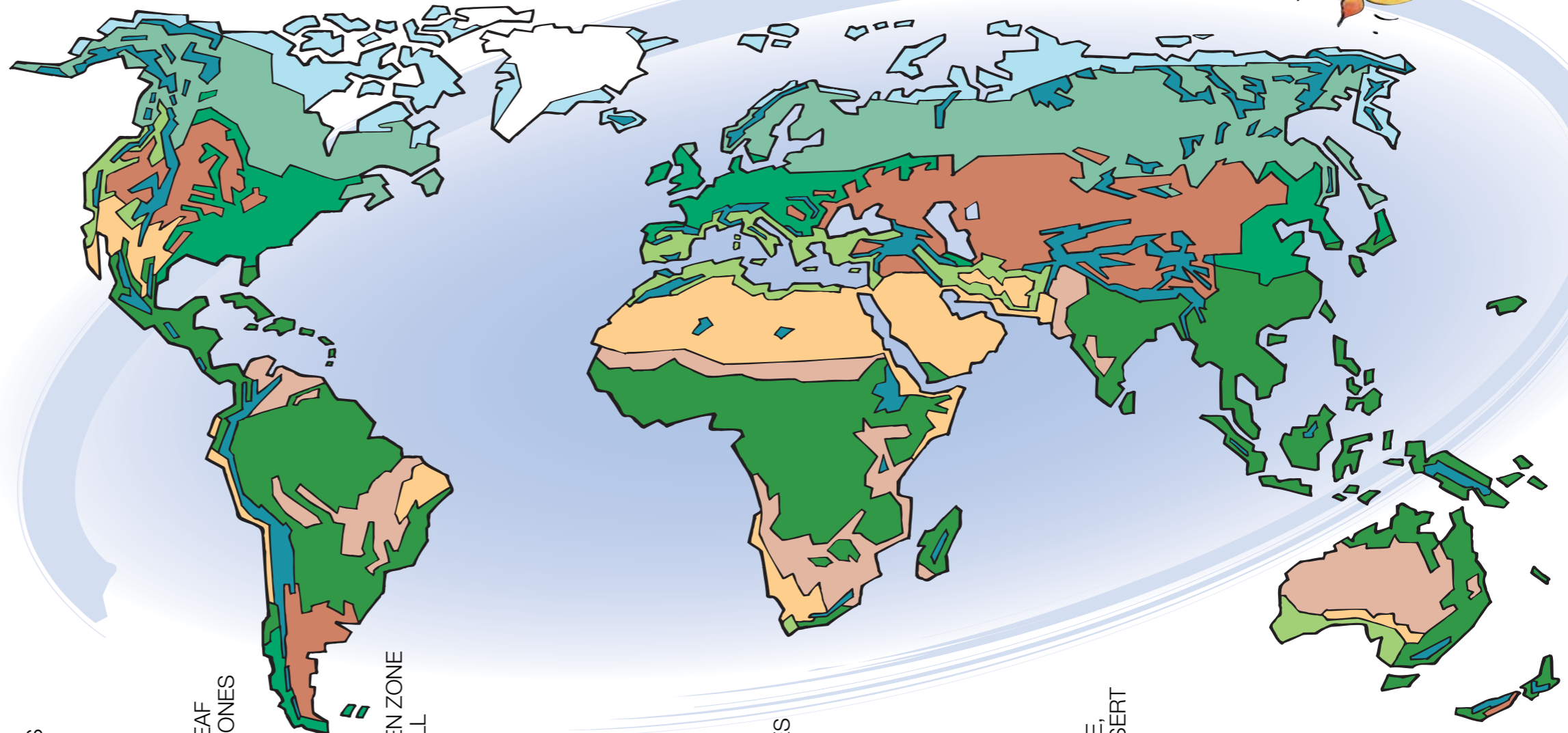

BOREAL CONIFEROUS FOREST ZONE



DECIDUOUS BROADLEAF AND MIXED-FOREST ZONES



MEDITERRANEAN HARDLEAF EVERGREEN ZONE WITH WINTER RAINFALL



TROPICAL TO WARM TEMPERATE FOREST



SAVANNAH AND DESERT-SHRUB ZONES



HOT DESERTS AND SEMI-DESERTS



COLD-WINTER STEPPE, TEMPERATE SEMI-DESERT AND DESERT ZONES



HIGH ALPINE



TUNDRA AND POLAR DESERT



BOREAL CONIFEROUS FOREST ZONE

DECIDUOUS BROADLEAF AND MIXED-FOREST ZONES

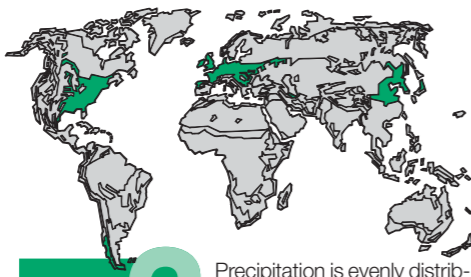
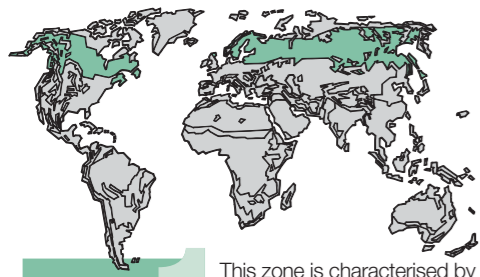

1 This zone is characterised by its continental-type climate of short, warm summers and long, severe winters. Evergreen climbing shrubs such as ivy are at their climatic limit in this zone.

The hardiness of deciduous climbing shrubs make them suitable for this climate.

- Clematis alpina, sibirica, vitalba, virginiana, macropetala, tangutica
- Parthenocissus quinquefolia
- Polygonum auberti, baldschuanicum
- Celastrus scandens
- Actinidia kolomikta, arguta, etc. (with edible fruits)
- Vitis aestivalis, amurensis, riparia

2 Precipitation is evenly distributed throughout the year. The summers are warm, the winters moderately cold – the climate typical of Central and Western Europe.

Temperatures lower than –15°C tend to occur rarely in Central Europe, and hard frosts (below –5°C) are hardly to be expected in oceanic regions such as the broadleaf forest zone of Eastern Asia or New Zealand. In contrast, the temperature can sink to –30°C and even lower in the north of the USA. The species that flourish in these regions are those listed under the boreal coniferous forest zone heading. Experts should be consulted in case of doubt.

- In the regions with a moderately cold winter (Central and Western Europe), a wide range of attractive Clematises, Loniceras, climbing roses, etc., are available in addition to the “classics” listed in zone 1.
- Many plants that thrive in Mediterranean regions do well in the mild-winter regions of the deciduous forest zones. The hardier Passiflora species, Solanum crispum and Trachelospermum jasminoides flourish in the company of plants representative of the colder zones.



- 14.1 Clematis vitalba
- 14.2 Parthenocissus quinquefolia
- 14.3 Celastrus scandens
- 14.4 Vitis species
- 14.5 Climbing rose 'Westerland' combined with Clematis alpina and grape-vine shoots
- 14.6 Humulus lupulus
- 14.7 Actinidia arguta
- 15.1 Large-flowered Clematis 'Hagley Hybrid'
- 15.2 Lonicera
- 15.3 Campris x tagliabuana "Mme Galen"
- 15.4 Clematis fargesii
- 15.5 Large-flowered Clematis 'The President'
- 15.6 Ampelopsis brevipedunculata
- 15.7 Campsis grandiflora
- 15.8 Campsis radicans
- 15.9 Clematis montana 'Marjorie' with Elaeagnus angustifolia
- 15.10 Passiflora caerulea

MEDITERRANEAN HARDLEAF EVERGREEN ZONE WITH WINTER RAINFALL



3 Such zones are found around the Mediterranean Sea, in California, on the Cape and in South Australia. They are characterised by hot, dry summers and mild, humid winters. Light frosts are exceptional. A great variety of attractive climbers and wall shrubs flourish here in all their splendour. These include Bougainvillea and many Passifloras (*Passiflora coerulea*, *amethystina*, *mollissima*, *antioquiensis*, *Distictis buccinatoria*, *Pandorea jasminoides*, *Podranea ricasoliana*, *Beaumontia grandiflora*...). In addition, somewhat tender climbing roses such as *Rosa brunoni* 'La Mortola' or 'Banks's rose' (*Rosa banksiae*) do well here. Watering during the summer months is essential.

TROPICAL TO WARM TEMPERATE FOREST

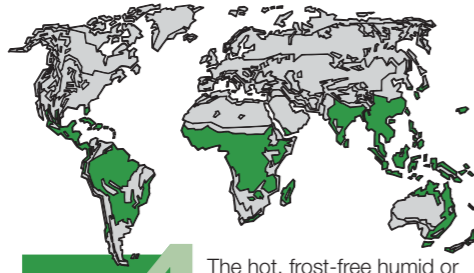

4 The hot, frost-free humid or variably humid climate supports lush vegetation consisting of a wide range of plants. Many of these familiar to us in Mediterranean gardens (such as Bougainvillea) grow well in this zone, including those that require considerable warmth such as *Thunbergia grandiflora* and *mysorensis*, *Passiflora coccinea*, *quadrangularis* (giant granadilla), *Petraea volubilis*, *Clytostoma calistegioides*, *Allamanda cathartica*, *Pyrostegia venusta*. Many species grow satisfactorily in a warm temperate climate (North Island of New Zealand) as well as in the tropics. Other varieties, however, require the humid heat of equatorial regions (e.g. *Strongyloclon macrobotrys*).

SAVANNAH AND DESERT SHRUB ZONES

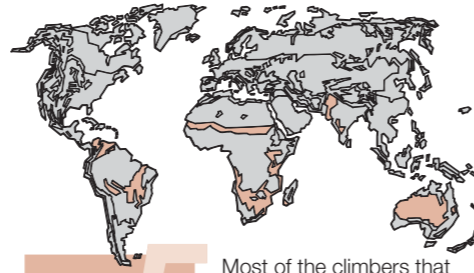

5 Most of the climbers that are used in zone 4 will grow well in zone 5 when the microclimatic conditions are observed and water management is satisfactory.

HOT DESERTS AND SEMI-DESERTS



6 Provided that an efficient watering system is available, buildings in these hot, dry regions can be greened to contribute significantly towards a pleasant room temperature. Combination with reliable desert periphery plants (*Acacia* species, *Tamarix*, *Casuarina*, etc.) is good practice because the resulting filter effect slows down wind and drifting sand.

Climbers and espaliered plants from the gardens of the usually neighbouring Mediterranean hard-leaf zone such as *Kennedyia coccinea*, *Podranea ricasoliana* or even *Pyrostegia vinusta* will grow on buildings with considerable vigour when they are well tended and watered.

COLD-WINTER STEPPE, TEMPERATE SEMI-DESERT AND DESERT ZONES



7 The zone of opposites. Hot summers are followed by severe winters. The hardy plants listed under borean coniferous forest zone such as *Clematis tangutica*, *alpina* and *siberica* can be used here. Watering is always essential. The oleasters *Elaeagnus angustifolia* and *commutata* are suitable for use as windbreaks.

HIGH ALPINE (8), TUNDRA AND POLAR DESERT REGIONS (9)

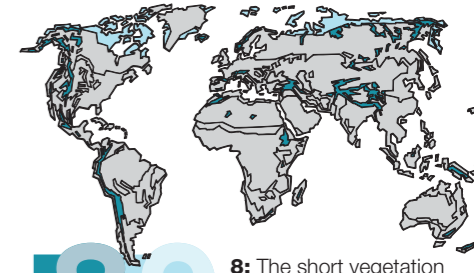

8 The short vegetation period makes life difficult for plants that want to climb. However, with careful attention paid to the microclimate (exposure, wind, altitude, topography), the climbers from the coniferous forest zone certainly have a chance of succeeding.

9: Greening buildings with climbing plants in this vegetation-less zone is virtually impossible.

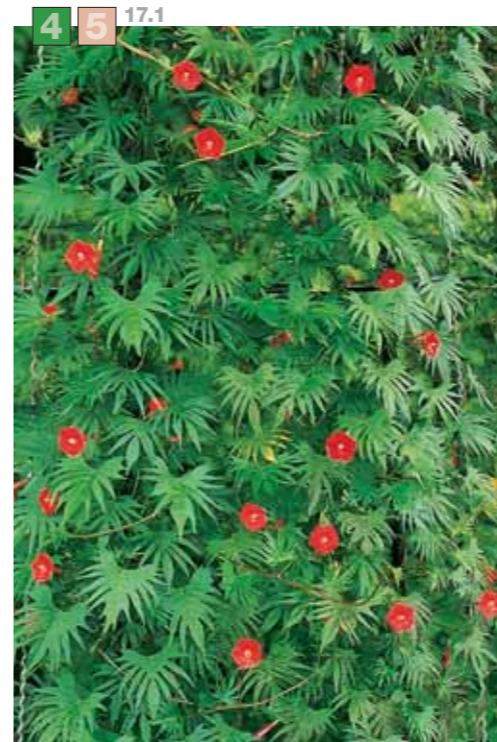
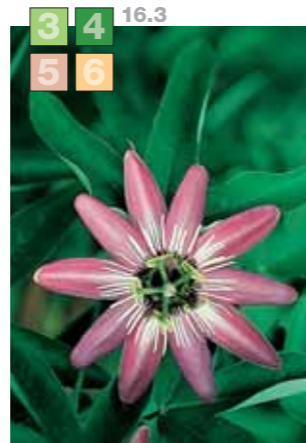
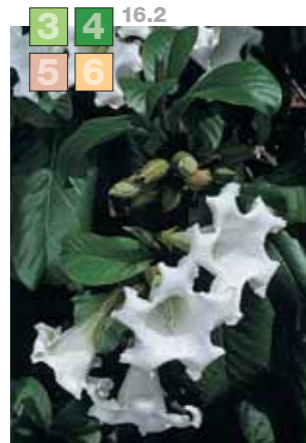

- 16.1 *Solandra grandiflora*
- 16.2 *Beaumontia grandiflora*
- 16.3 *Passiflora amethystina*
- 16.4 *Berberidopsis corallina*
- 16.5 *Distictis buccinatoria*
- 16.6 *Thunbergia grandiflora*
- 16.7 *Epipremnum aureum* 'Marble Queen' (syn. *Scindapsus aureus*)
- 16.8 *Passiflora quadrangularis*
- 16.9 *Passiflora coccinea*
- 17.1 *Ipomoea quamoclit* (syn. *Quamoclit pinnata*)
- 17.2 *Cobaea scandens*
- 17.3 *Hoya carnosa*
- 17.4 *Pyrostegia venusta*
- 17.5 *Clematis tangutica*

DIMENSIONING TRAINING SYSTEMS

The overall load of a greened surface is composed of:

- Weight of the plant
- Wind load on plant surface
- Weight of dew and rain
- Weight of snow
- Weight of training structure

Load distribution

If the entire vertical load is absorbed solely by the training system at the top and bottom, the upper suspension must hold the entire vertical load and half the wind load. The bottom suspension must hold only half the wind load.

The safety factor

The defined vertical load to be absorbed by the upper suspension must be multiplied by a safety factor.

A: PLANT WEIGHT

Depending on the variety, the unit weight per square metre of plant area can vary from 1 to 50 kg/m².

The plant weight is influenced by the location, the soil quality, the growth rate and owner care.

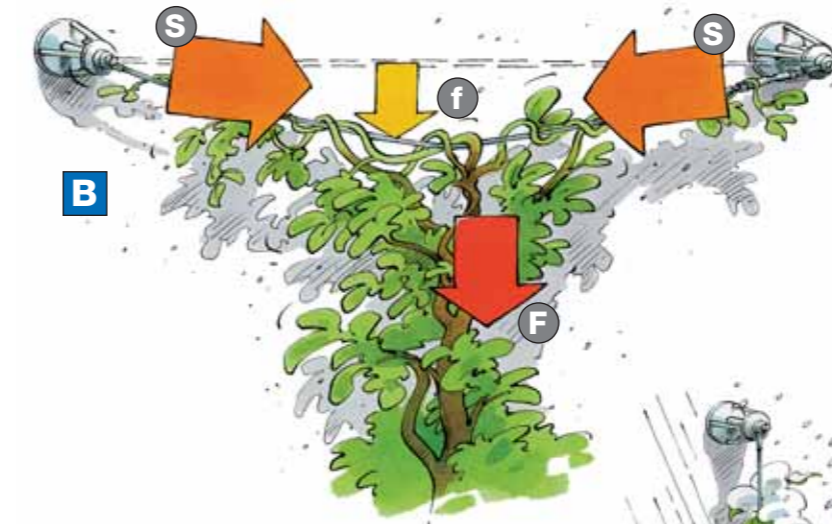
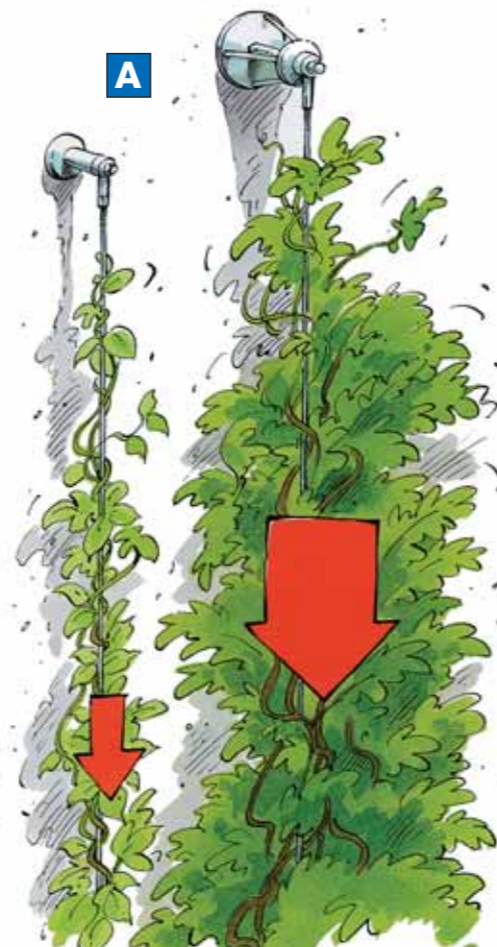
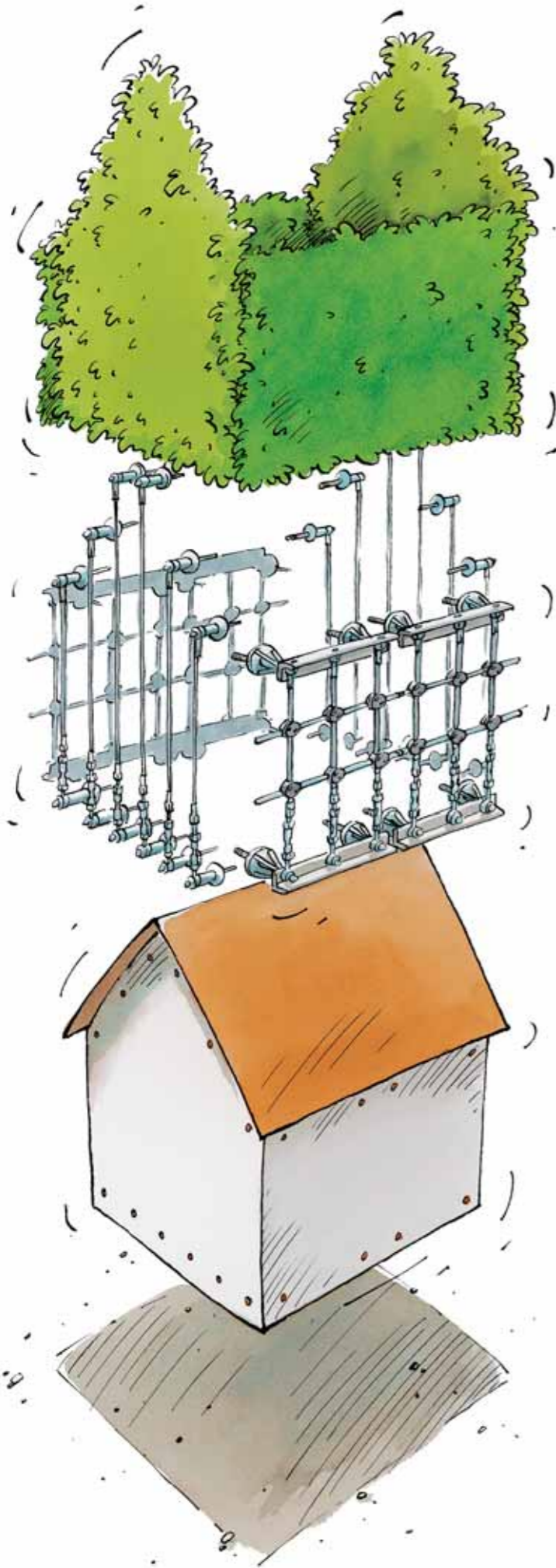

B: HORIZONTAL AND VERTICAL WIRE ROPES

When computing rope forces, a distinction must be made between horizontally and vertically tensioned wire ropes.

Intermediate supports for rods and wire ropes

The sag (f) of horizontal or inclined rods and wire ropes can be diminished with intermediate supports.

C: WIND LOAD

When planning and installing training systems, the wind load is an important aspect. It is composed of wind pressure and wind suction as well as side winds on the greened surface. Although it can be assumed that part of the wind will breeze through the vegetation, we recommend looking at the greened mass as a solid surface.

The following suggested values apply to wind suction calculations:

- Height above ground up to 8 metres: approx. 0.5 kN/m²
- Between 8 and 20 metres above ground: approx. 0.8 kN/m²
- Higher than 20 metres above ground: 1.1 kN/m²

A suction effect on the vegetated surface occurs when the wind blows parallel to the greened surface. The resulting tensile forces must be transmitted to the building structure via the dowels.

Incident side winds impose a bending moment on the spacers. In special cases, it may be necessary to reinforce the spacers and/or guy them down with wire ropes.

Where trainers are subsequently attached to a building structure, it should be determined if and at which locations the computed forces are transmitted and where they can be diverted into the foundation.

In new buildings, it is the planner's responsibility to investigate whether and how training systems should be included and mounted.

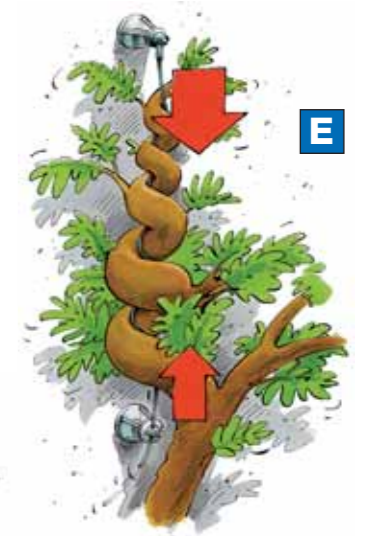
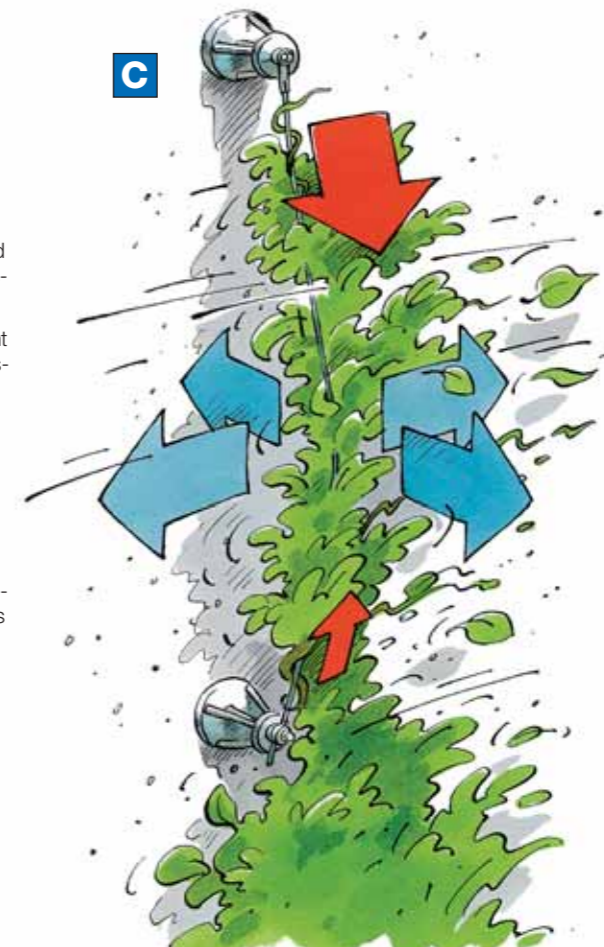

D: DEW, RAIN, AND SNOW LOADS

In addition to the weight of the plant, the training structure must also be capable of absorbing dew, rain, and snow loads. This load is factored in by multiplying the plant weight by the following coefficients:

For deciduous plants: plant weight times 2; for evergreens: plant weight times 3.

E: STRONG TWINING CLIMBERS

At least one end of the wire rope which holds climbers that twine significantly (Wisteria, for example) must be protected with a Jakob® INOX LINE overload clamp (No. 30920-0400-10, page 65). This is the only way to prevent major façade damage by tensile overloads on spacers (Fig. 2, page 29).

WALL-MOUNTING SPACERS ON VARIOUS BUILDING MATERIALS

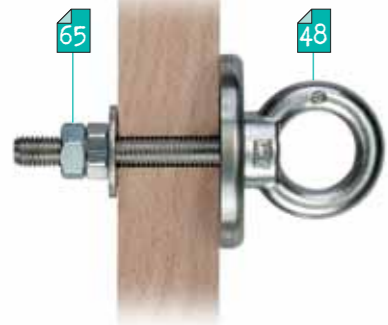

Through hole in wood
Headless screw with nut and check nut at back, front ring nut with support washer to absorb lateral forces at front.

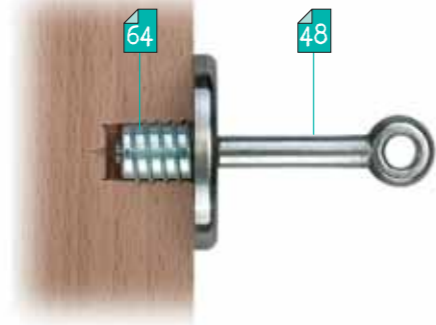

Screw-in nut for wood
The metric internal thread of the screw-in nut accepts a rope holder or a headless screw.

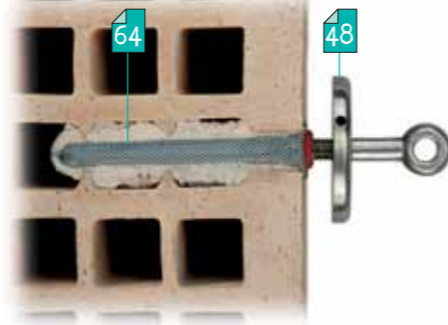

Perforated hollow wall anchor
The perforated anchor is secured with a two-component mortar. The metric internal thread accepts a rope holder.

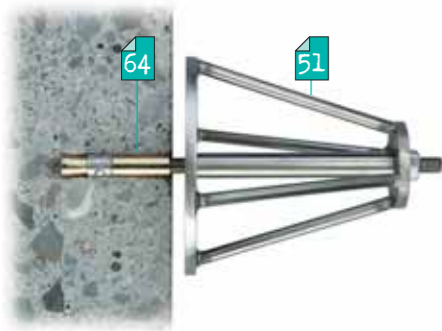

Bolt anchor with internal thread
Suitable for concrete façades and hard stone. The bolt anchor expands and grips when the threaded rod is screwed in.

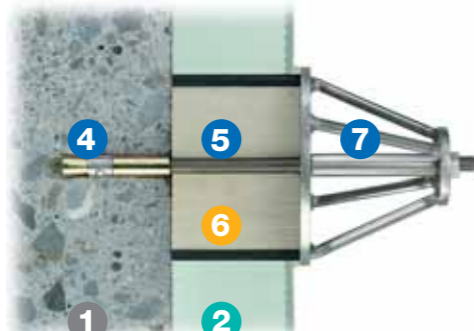

Externally insulated façades
The spacer is mounted on an insulated support tube and thus transfers lateral forces to the substrate (see Figs. A to F).

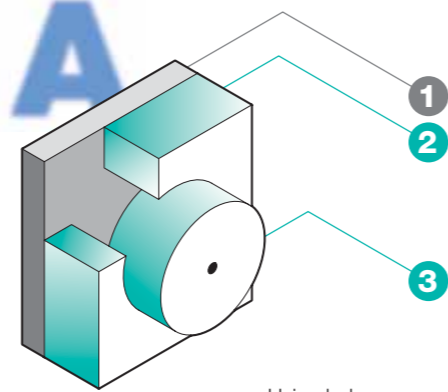

Using hole saw, core out external insulation (2) on façade (1) and remove insulation piece (3).

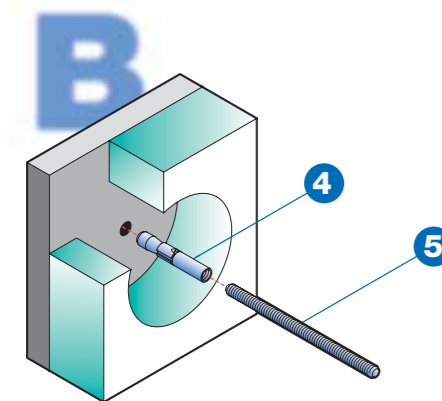

Screw threaded rod (5) into bolt anchor with internal thread (4) and tighten.

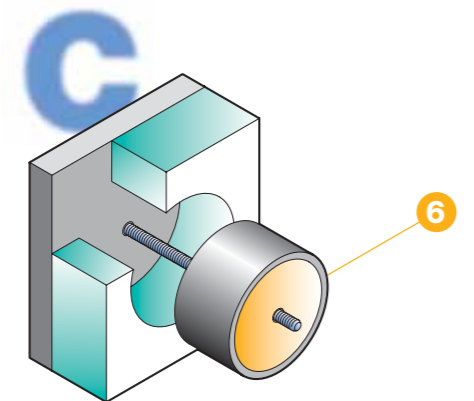

Slide foamed support tube (6) over threaded rod. Support tube length approx. 5 to 8 mm larger than insulation thickness.

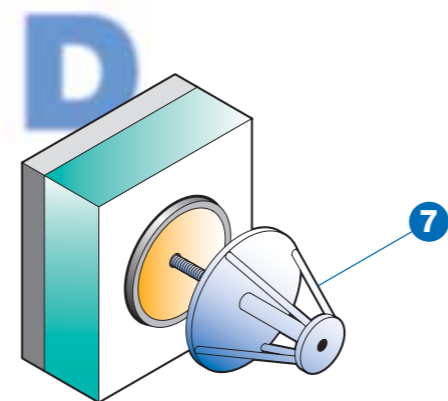

Slide spacer basket (7) on threaded rod and align.

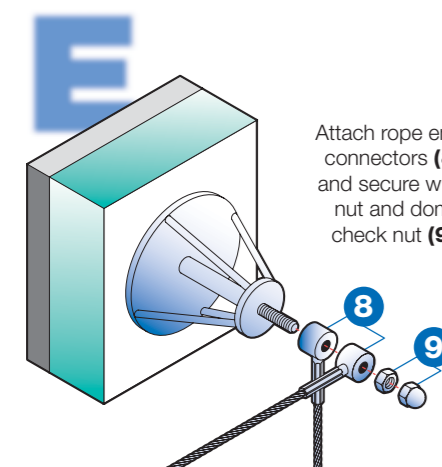

Attach rope end connectors (8) and secure with nut and dome check nut (9).

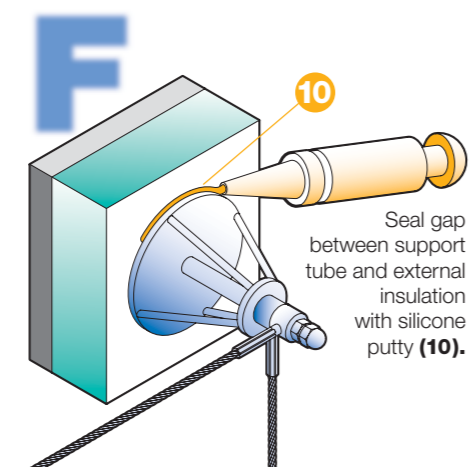

Seal gap between support tube and external insulation with silicone putty (10).

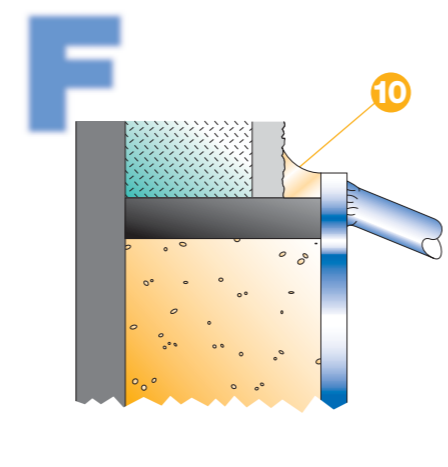

TRAINING SYSTEMS IN THE JAKOB LINE

Choosing suitable materials
The different atmospheric conditions (rural, urban, industrial) determine the selection of materials. Urban and industrial atmospheres may contain aggressive carbon-containing particles and sulphur dioxide (SO₂). At sea level, the air contains aerosols with chloride ions. Rural air is usually unproblematic.

All parts of the Jakob® INOX LINE are made of AISI 316, 1.4401, and AISI 316L, 1.4404, alloys to offer excellent corrosion resistance.

AISI 316
1.4401, EN 10088-3 X5CrNiMo17-12-2

AISI 316L
1.4404, EN 10088-3 X2CrNiMo17-12-2

The life span of plants for façade greening can range from 30 to 100 years! To assure that the training systems outlive the plants, the selection of materials is very crucial.

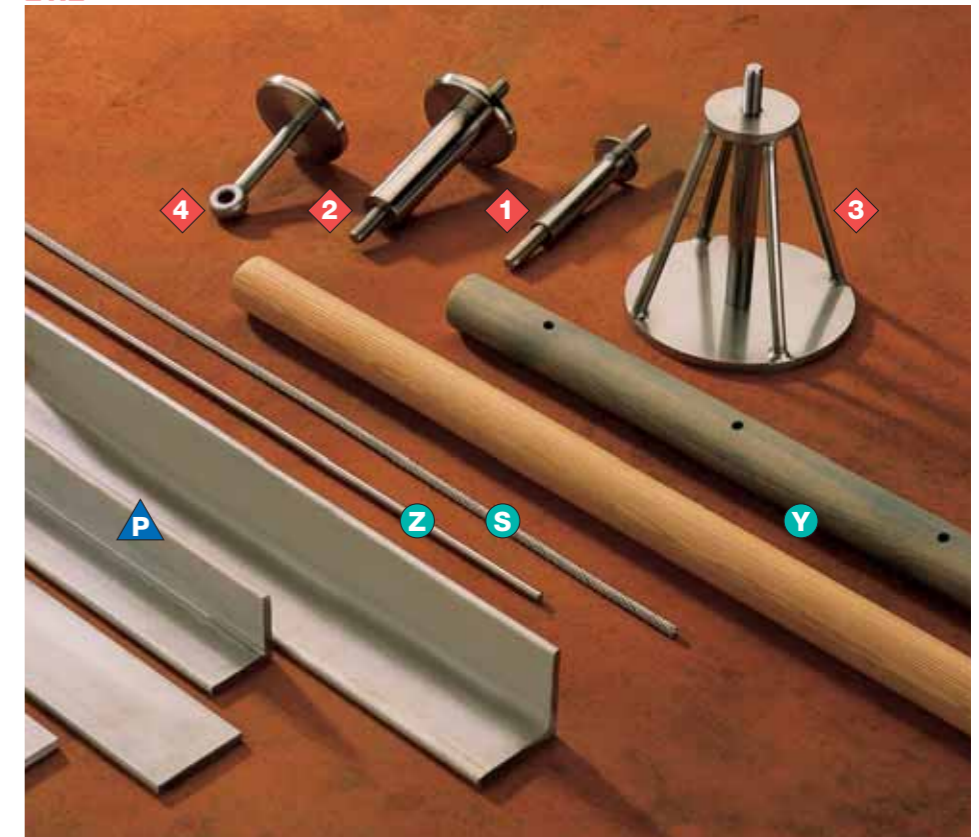

ROPES / RODS / SECTIONS

The wire ropes have a rated diameter of 4 mm (actual: Ø 3.7 mm). **A yellow code filament (S) confirms the authenticity of the rope** made from AISI 316 and guarantees a minimum breaking load of 9.1 kN. The 3.7 mm diameter ground rods (Z) are also made from AISI 316; they have a minimum breaking load of 5.5 kN.

Our wooden rods (Y) have a diameter of 25 mm. They are made either of glazed spruce (grey) or untreated larch. All wooden rods are available with cross bores (Ø 0.5 mm) along their entire length.

- Wall mounts**
- Spacer Ø12/24 (1)
 - GreenGuide spacer Ø 20/50 (2)
 - Spacer basket Ø 40/100 (3)
 - Eye bolt with support washer (4)
- Brackets (P) for spacers**
- Angle section 30 / 30 / 4 mm
 - Angle section 40 / 40 / 4 mm
 - Flat section 30 / 4 mm
 - Flat section 40 / 4 mm

Dimensions (mm)	J (cm ⁴)	W (cm ³)	kg/m
40 / 40 / 4	4.48	1.56	2.42
30 / 30 / 4	1.81	0.86	1.78
40 / 4	2.13	1.06	1.26
30 / 4	0.90	0.60	0.94

J = moment of inertia / W = moment of resistance

PLANNING AIDS FOR THE ENGINEER

The following parameters are important for planning a training system:

- Selected plant and its weight per m²
- Deciduous or evergreen?
- Which configuration of ropes/rods is needed (horizontal/vertical/combined/inclined, etc.)?
- Orientation: South/North/East/West? Special site conditions such as wind, etc.
- Rope/rod grid aperture and wall clearance
- Length and width of greened area (sketch with dimensions)
- Jakob® INOX LINE catalogue

SPACER LOAD DIAGRAM

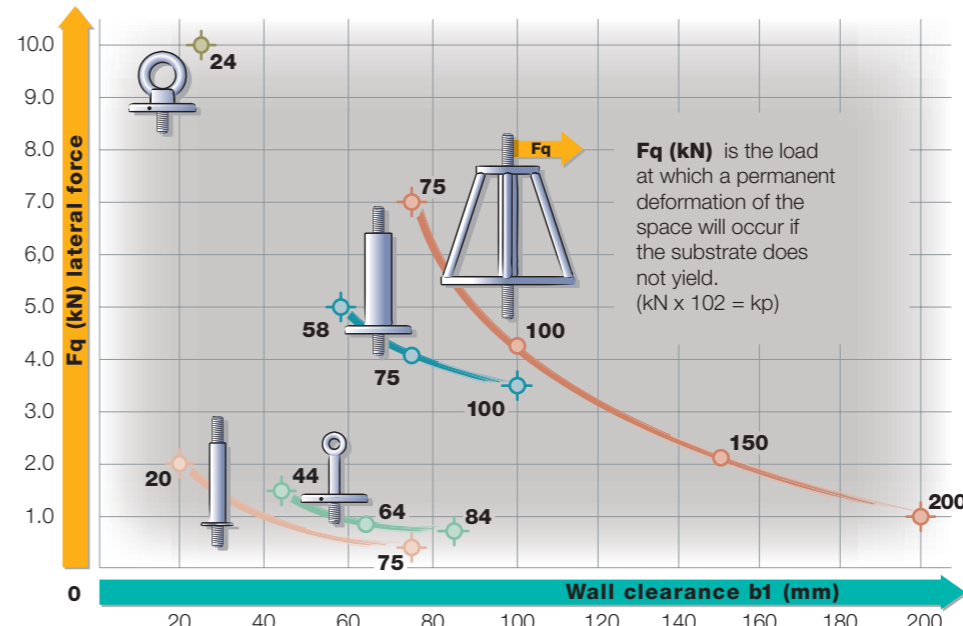

A B C

DIY ASSEMBLY OF END CONNECTORS

Technically mature end connectors make it possible to complete the termination of the wire ropes on site. Non-tensionable end connectors **(A)** are swaged with the rope at the factory.

- The rope **(B)** can be terminated to the correct length on site with the separately supplied LT2 external thread ends **(C)** (Fig. 45.1, page 45) and wire rope cutters.

D

ADJUST AND SECURE ROPE TENSION

Using the tensionable end connectors **(D)** which should be located at easily accessible points of the installed training system, the wire ropes can be moderately tensioned.

- If the tension is too high, the spacers and anchors will be unnecessarily burdened. The tension should be great enough to prevent the ropes and plants from being rocked back and forth by the wind.
- The end connectors should be secured with check nuts to prevent unintentional loosening.
- Find out if the training system should be electrically earthed.

E

SELECTING THE APPROPRIATE CLIMBERS

Ecological considerations speak in favour of including indigenous plants in the selection.

- Basically, local greening specialists should be consulted.
- Some ideas are provided on pages 12 to 17.

F G

CARING FOR GREENED FAÇADES

Simple façade vegetation requires little care. Sophisticated and attractive plant combinations with climbing roses, Clematis, grape vines or kiwis need to be cared for by professionals on a regular basis. This care is rewarded with blossoms, fruit, and freedom from pests.

- Training systems that are compatible with the intended plants generally eliminate the need for attaching the plants. Climbing roses and grape vines are exceptions to this rule. However, climbers do need a good manual or automatic water and nutrient supply.

- Pest problems will hardly occur if the plants are compatible with the site. Pesticides should not be used in residential zones.

- Many climbers (such as honeysuckle) only need to be cut back if their growth is to be controlled. Climbing roses, many Clematis varieties, grape vines and kiwis will grow vigorously and stay healthy if professionally cut. They will look better and develop more blossoms and fruit as well.

- In the course of the years, the weight of the plants will increase. It may be necessary to retension the wire ropes or add anchors and reinforcement elements.

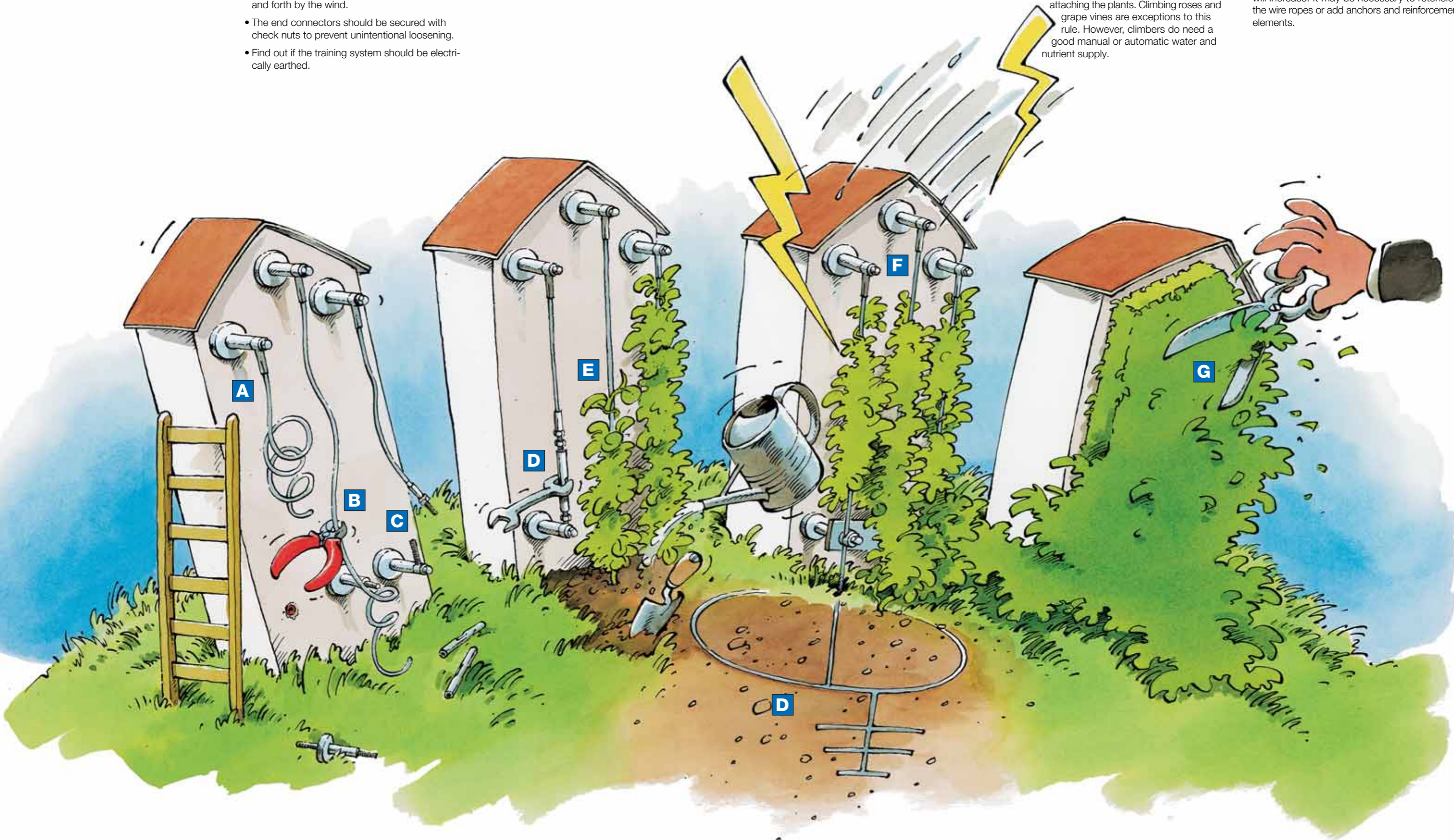



Pages 26 27

GREENGUIDE ROPE STYLES F1/F2/F3
For DIY installation / Material: AISI 316 (V4A)

Completely terminated wire ropes with top and bottom spacers. Types F1, F2, and F3 are designed for different load cases and available for different wall clearances.



Pages 28 31

GREENGUIDE ROPE STYLE F4
For DIY installation / Material: AISI 316 (V4A)

Training structure tailored to your dimensions. The stainless steel angle sections can be supplied with all mounting holds. The scope of the product line covers various load cases.



Pages 32 35

GREENGUIDE ROPE STYLE F5
For DIY installation / Material: AISI 316 (V4A)

Training structure tailored to your dimensions. The top and bottom mounting sections can be inclined at any angle (under a pitched roof, for example). Wall clearances and loads variable.



Pages 36 37

GREENGUIDE ROPE STYLE F6
For DIY installation / Material: AISI 316 (V4A)

The training structure consists of two spacers for the beginning and end of the wire rope as well as of deflectors.

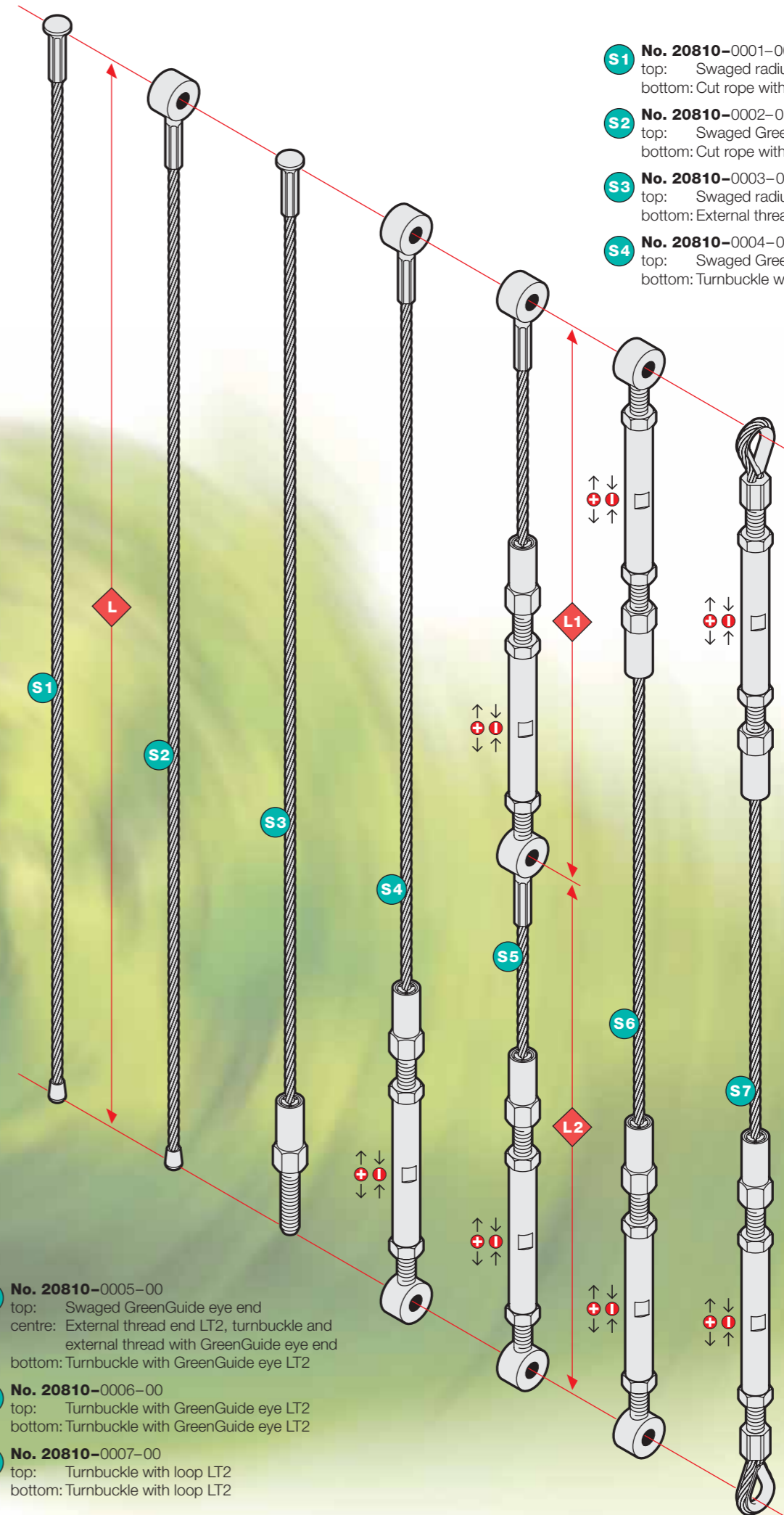

- S1** No. 20810-0001-00
top: Swaged radius head end stop
bottom: Cut rope with end cap
- S2** No. 20810-0002-00
top: Swaged GreenGuide eye end
bottom: Cut rope with end cap
- S3** No. 20810-0003-00
top: Swaged radius head end stop
bottom: External thread end LT2
- S4** No. 20810-0004-00
top: Swaged GreenGuide eye end
bottom: Turnbuckle with GreenGuide eye LT2

Ropes for GreenGuide rope styles F1 - F6
Ropes S1 to S7 include all versions which can occur in GreenGuide rope styles and training structures.

Assembly lengths
All tensionable end connectors are supplied as DIY assembly parts. This allows the exact rope length to be determined on site. The ordered rope length should be about **10% longer** than the planned length.

On-site assembly
see Fig 45.1, page 45

Tensioning range
information: both thread ends are screwed halfway into the turnbuckle body.

← ⊕ → = make longer (relax) **8 mm**
→ ⊖ ← = make shorter (tension) **24 mm**

- S5** No. 20810-0005-00
top: Swaged GreenGuide eye end
centre: External thread end LT2, turnbuckle and external thread with GreenGuide eye end
bottom: Turnbuckle with GreenGuide eye LT2
- S6** No. 20810-0006-00
top: Turnbuckle with GreenGuide eye LT2
bottom: Turnbuckle with GreenGuide eye LT2
- S7** No. 20810-0007-00
top: Turnbuckle with loop LT2
bottom: Turnbuckle with loop LT2

! The load and design of a greening system depends on various factors. Please consult pages 18, 19 and 21 for details.



D2: Intermediate spacer (rope clamped) with maximum clamping force of 1 kN.

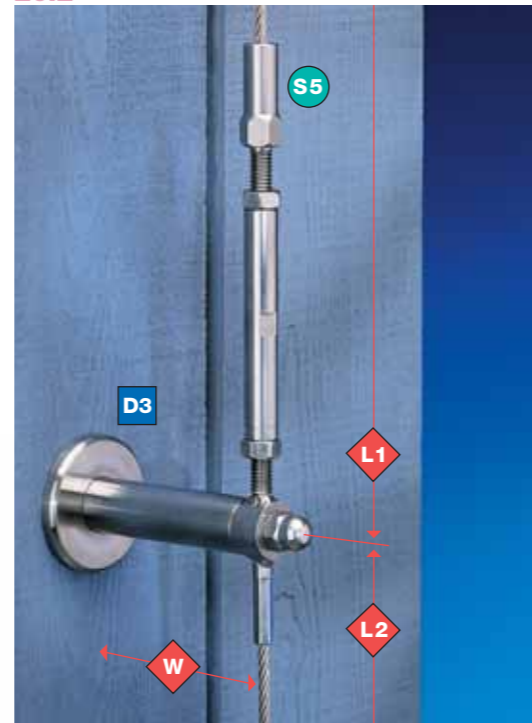

D3: Intermediate spacer (rope tensionable) for long wire ropes.



GREENGUIDE ROPE STYLES F1/F2/F3

For on-site assembly / Patent/DBGM pending
 Material: ropes AISI 316, fittings AISI 316L
 To order: see examples on opposite page

	F1 Spacer Ø 12/24	F2 Spacer Ø 20/50	F3 Spacer Ø 40/100	Info: Page
D1 Top spacer	for swaged GreenGuide eye end (non-tensionable end connector)			21, 25
D2 Intermediate spacer	clamped for contiguous rope, clamped (rope S2 / S4 / S5)			25
D3 Intermediate spacer, tensionable	for external thread with GreenGuide eye end and turnbuckle (rope S5)			25, 45
D4 Bottom spacer	accepts rope ends S2 / S4 / S5			21, 25, 47
L Assembled rope lengths	indicate partial lengths L1 / L2 at intermediate spacer D3			25
W Wall clearances	variable to max. 81	64 / 81 / 106	87 / 112 / 162 / 212	40 / 41
S2 Rope with clamped end	/	/	/	25
S4 Rope with tensionable end connector	/	/	/	25
S5 Rope with tensionable end connectors	/	/	/	25
X Wall mounting on wood, hollow walls, concrete or external insulation. See installation principles and materials on pages				20, 64

see page no. 26.3 26.4

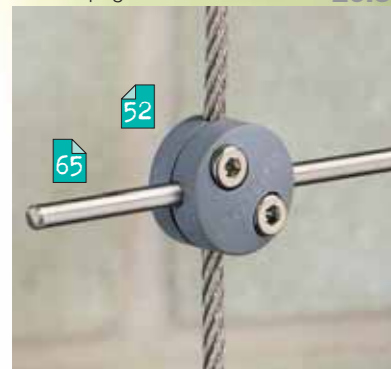

26.5

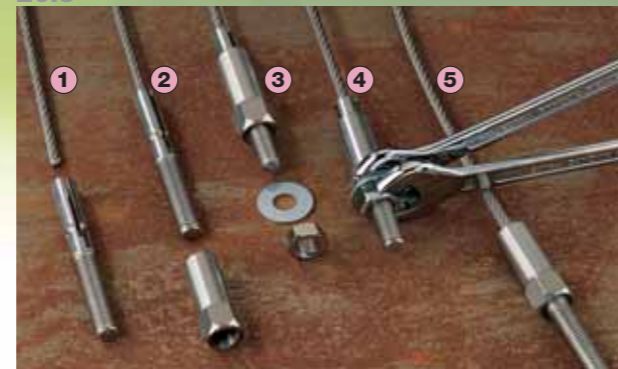

27.1



Ordering example (for the picture at right):
F1:
 D1 1pc.
 D4 1pc.
 L 2200
 W 70
 S2 1pc.
 X 2 pcs

L S
Assembled lengths (L / L1 / L2) for on-site assembly: Max. approx. 3000 mm. Please see notes on page 25.

! The user is responsible for choosing the correct assembly method (see Fig. 26.5) and the proper rope diameter. **Functionality** is guaranteed only by Jakob rope No. 10820-0400 with the yellow code filament. Have a civil engineer check **strength values** and permissible loads on the basis of the given load case (see page 21).

GREENGUIDE ROPE STYLE F4

For on-site assembly / Patent/DBGM pending / Material: ropes AISI 316, fittings AISI 316L

To order: see examples on page 31

! The load and design of a greening system depends on various factors. Please consult pages 18, 19 and 21 for details.

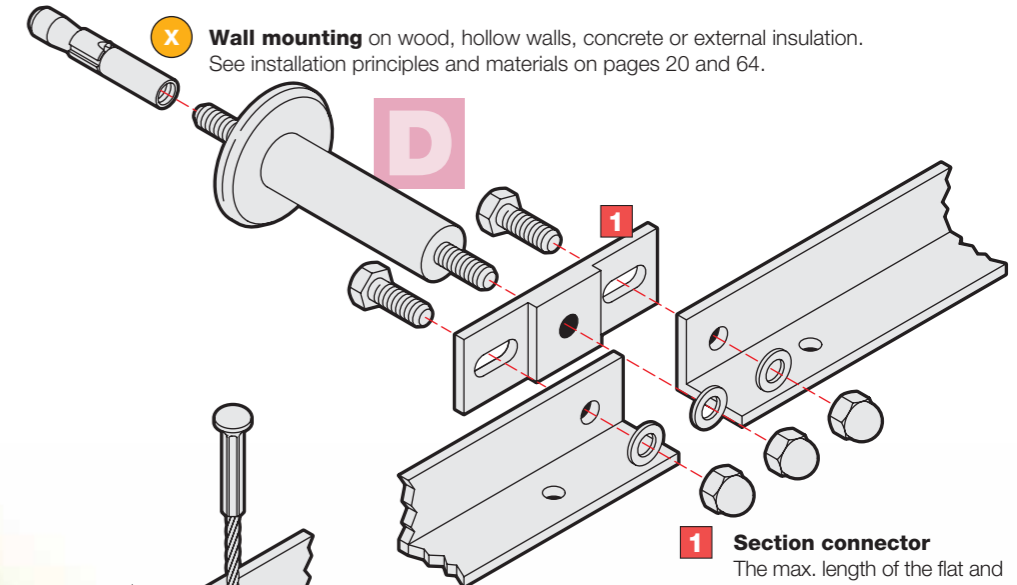
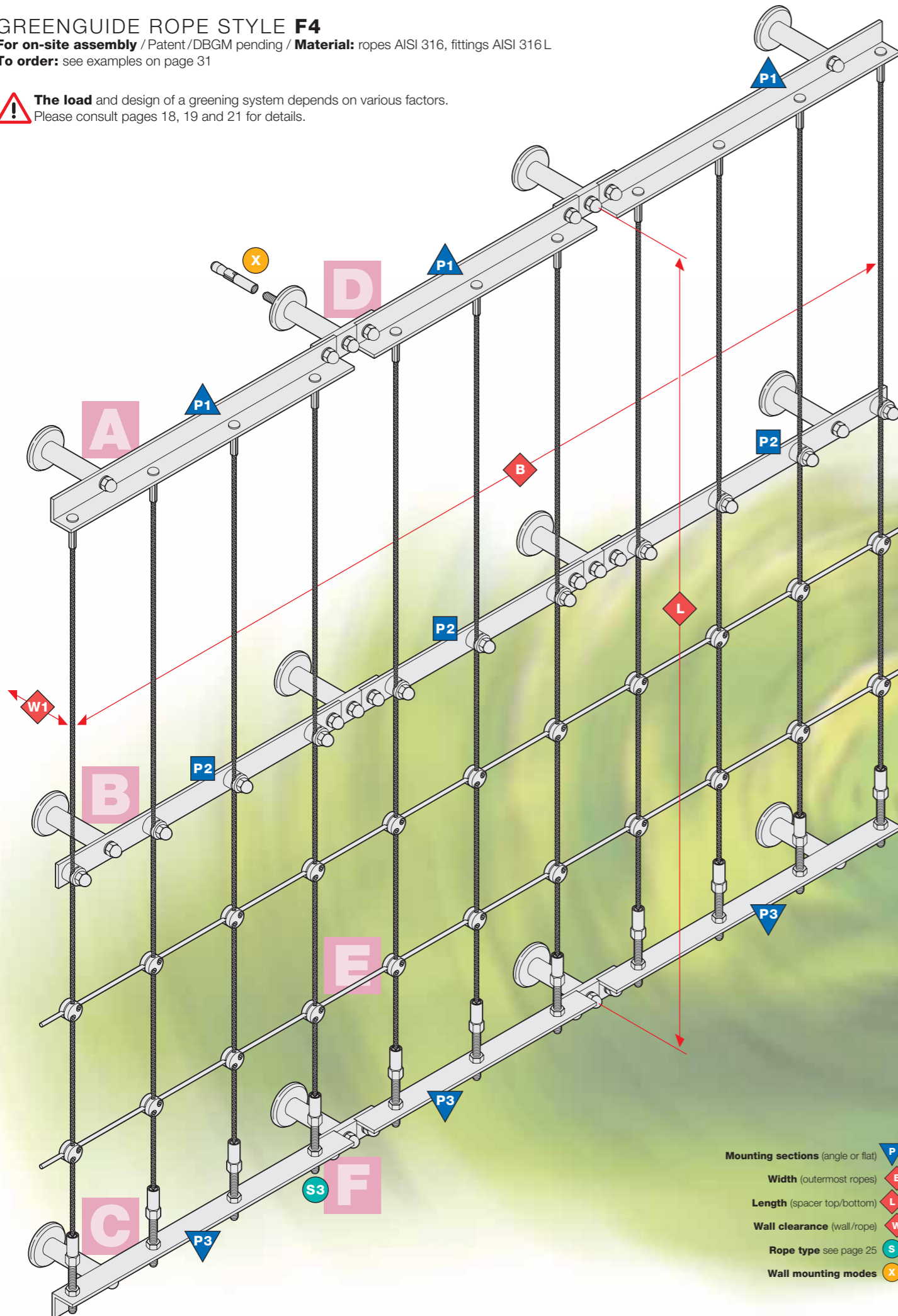

1 Section connector
The max. length of the flat and angle sections is 2000 mm. The section connector has two slotted holes. (Page 64: No. 30922-3004 and -4004)

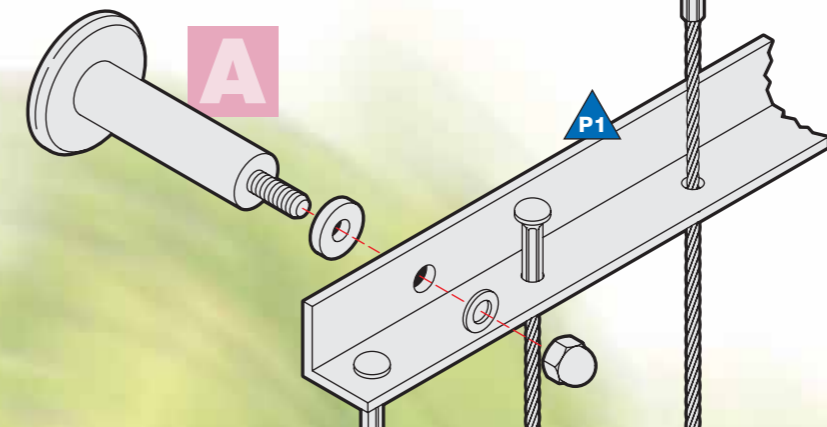

Horizontal rods combined with vertical wire ropes result in ideal training structures. Two different methods are available for attaching rods to wire ropes.

- GreenGuide 90° cross clamp
No. 30920-0400-02 (Fig. 30.5, page 30)
- Rope clip for stainless steel rods
No. 30920-0400-01 (Fig. 52.2, page 52)
- Horizontal rod Ø 3.7
No. 30922-0400-00 (page 65)

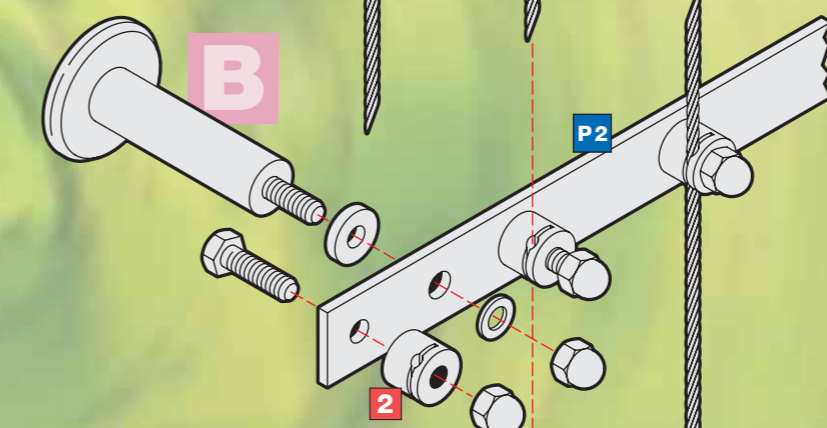

S3 Rope type S3
Rope S3 is supplied with a tensionable end connector and is intended for on-site assembly (rope types see page 25).

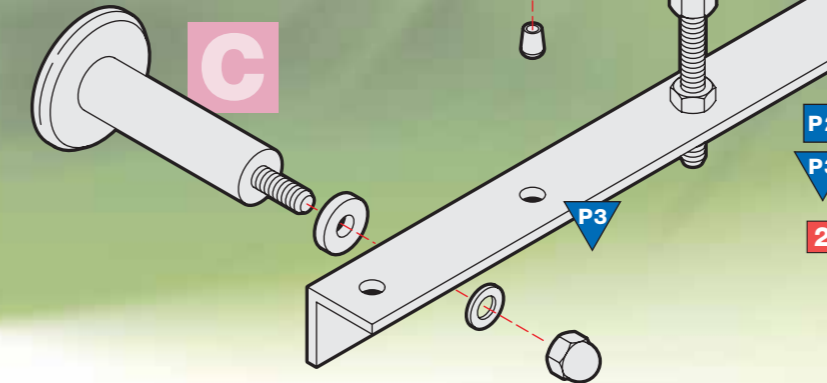

P2 Intermediate section P2 can also be used as a bottom mounting section P3, depending on function and load case (see Fig. 30.3, page 30).

P3 On the section (P3 as flat section), it is possible to clamp the end of the rope with the **GreenGuide overload clamp (2)**. The defined clamping force of 1 kN allows the rope to slip when gripped by vigorously twining climbers, thus lengthening the rope (see page 19, item E, and Fig. 54.2, page 54).



30.1 30.2

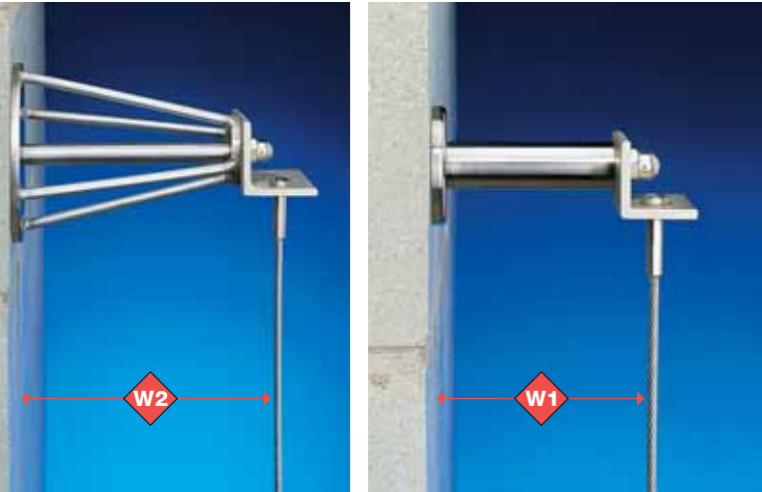

30.3

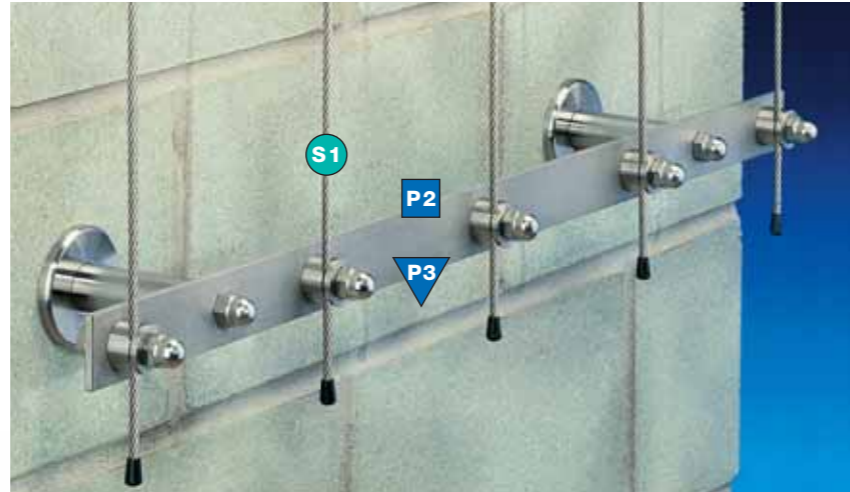

P2: Intermediate section for long ropes (see page 29)
P3: Bottom mounting section with clamped rope ends (see pages 29 and 54)

31.1

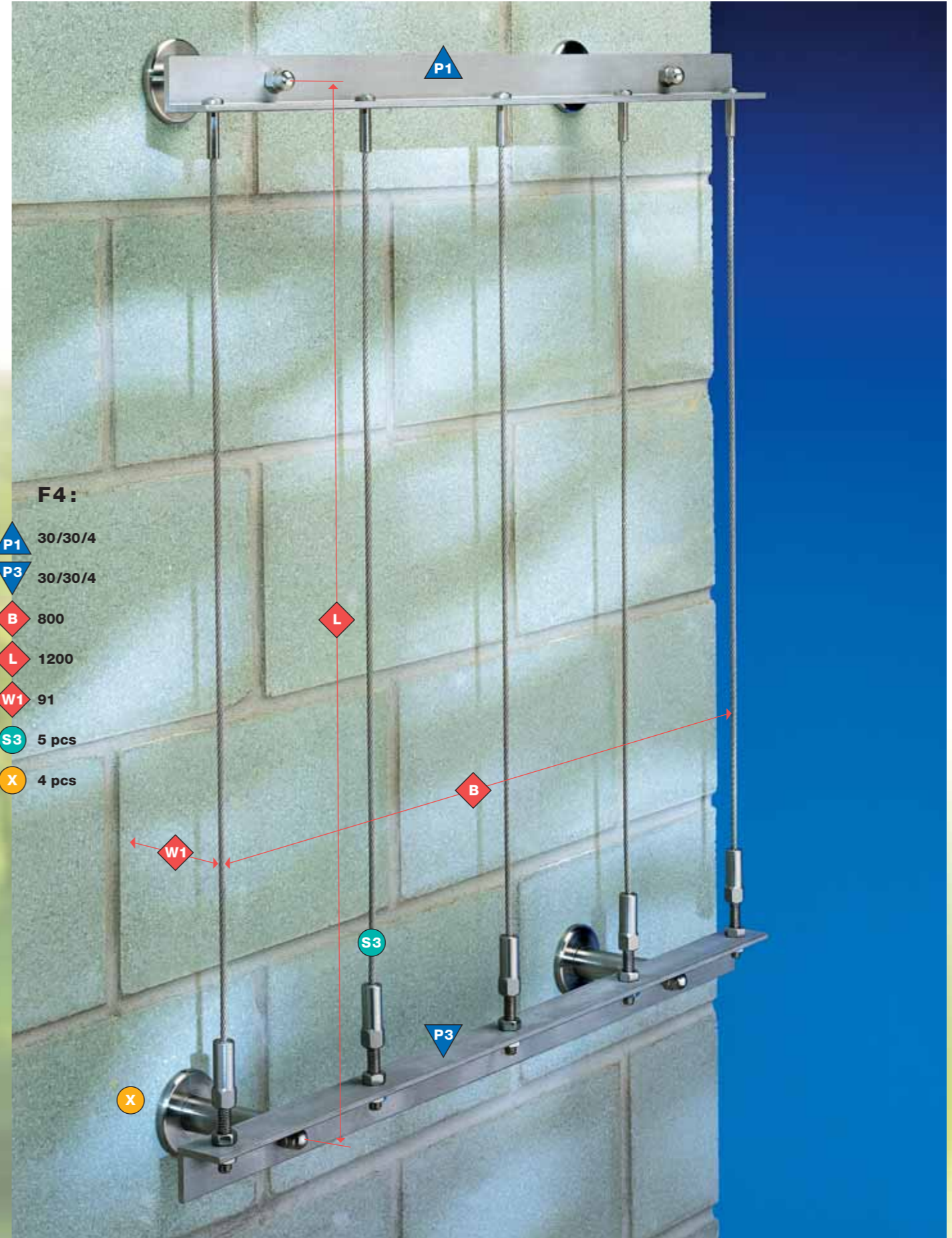

F4:

Ordering example (for the picture at right):

- P1 30/30/4
- P3 30/30/4
- B 800
- L 1200
- W1 91
- S3 5 pcs
- X 4 pcs



GREENGUIDE ROPE STYLE F4

For on-site assembly / Patent/DBGM pending / Material: ropes AISI 316, fittings AISI 316 L
To order: see examples on opposite page

	a	b	c	d	Info: Page
P1 Upper mounting section	Angle 30/30/4	Angle 40/40/4			21, 29, 64
P2 Intermediate mounting section			Flat 30/4	Flat 40/4	21, 29, 64
P3 Bottom mounting section	Angle 30/30/4	Angle 40/40/4	Flat 30/4	Flat 40/4	21, 29, 64
B Max. width with 2 spacers	Suggested: approx. 1500 (with W 100 and plant weight 15 kg/m ²)				
L Max. length with 2 spacers	Suggested: approx. 3000 (with W 100 and plant weight 15 kg/m ²)				
W1 Wall clearance with spacer Ø 20/50	See wall clearance table on pages				40/41
W2 Wall clearance with spacer Ø 40/100	See wall clearance table on pages				40/41
S Possible rope types: S1 / S3	See notes on pages				25, 29
X Wall mounting on wood, hollow walls, concrete or external insulation. See installation principles and materials on pages					20, 64

P Mounting sections
On request, we will supply the stainless steel sections ready to install with all holes (according to binding drawings).

Horizontal rods combined with vertical wire ropes result in ideal training structures. See description on page 29 and the figure below (30.5).

The load and design of a greening system depends on various factors. Please consult pages 18, 19 and 21 for details.

see page no.

30.4 30.5

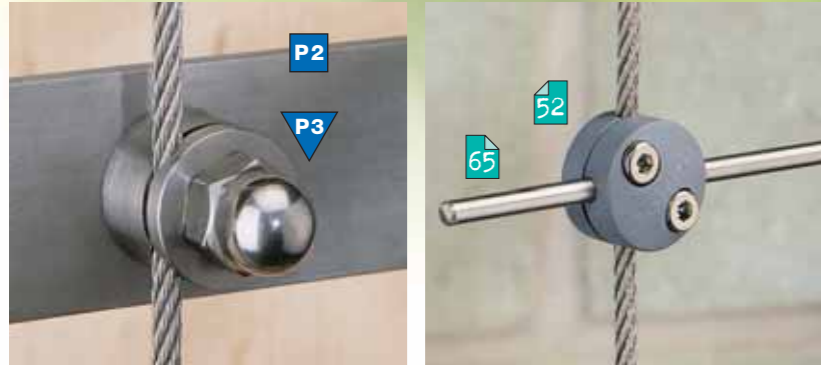

30.6



Assembled lengths for on-site assembly:
Please see notes on page 25.



The user is responsible for choosing the correct assembly method (see Fig. 26.5 on page 26) and the proper rope diameter. **Functionality** is guaranteed only by Jakob rope No. 10820-0400 with the yellow code filament. Have a civil engineer check **strength values** and permissible loads on the basis of the given load case (see page 21).

GREENGUIDE ROPE STYLE F5

For on-site assembly / Patent/DBGM pending / Material: ropes AISI 316, fittings AISI 316L

To order: see examples on page 35

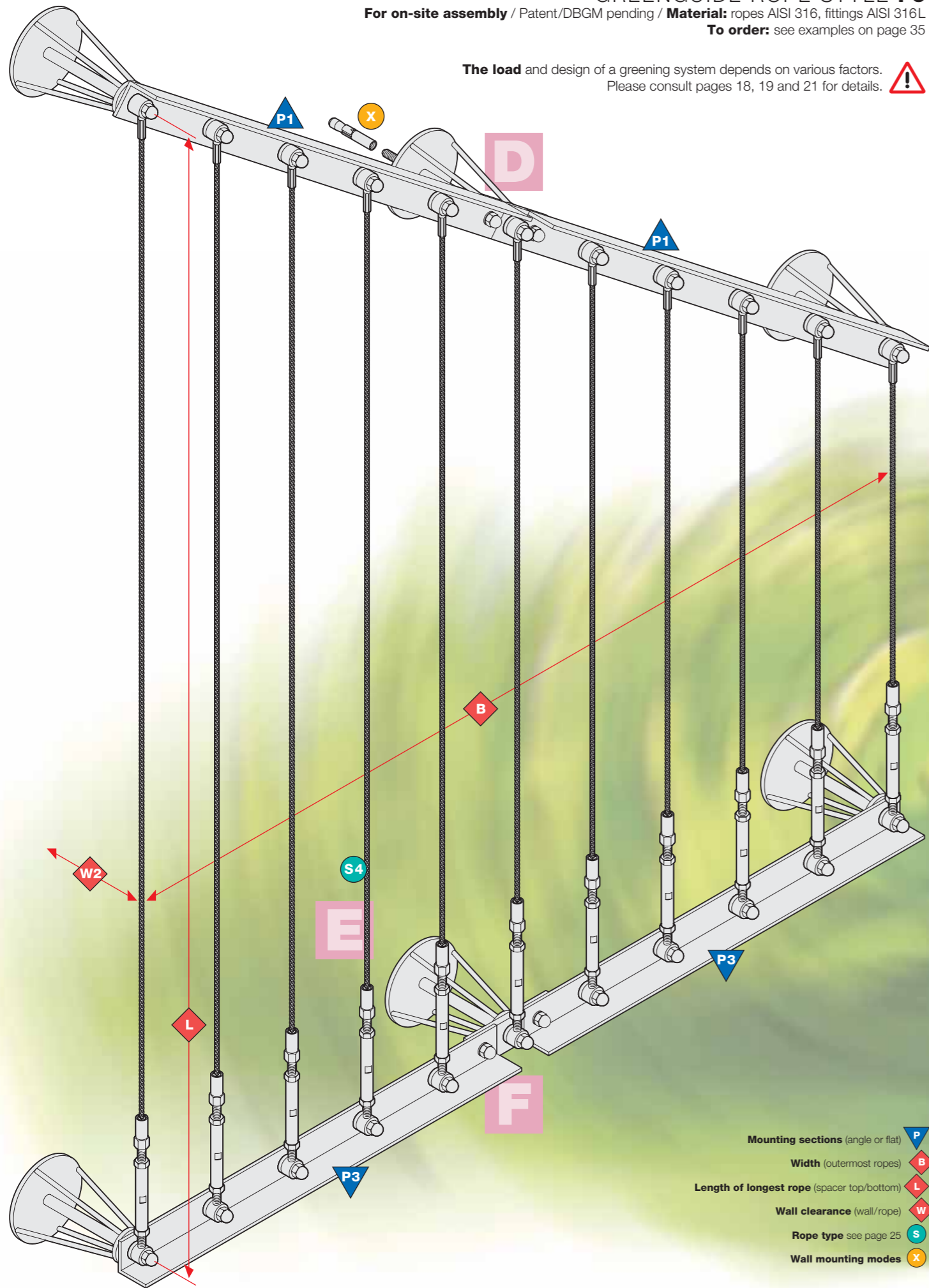

The load and design of a greening system depends on various factors. Please consult pages 18, 19 and 21 for details. 





-  **Mounting sections** (angle or flat)
-  **Width** (outermost ropes)
-  **Length of longest rope** (spacer top/bottom)
-  **Wall clearance** (wall/rope)
-  **Rope type** see page 25
-  **Wall mounting modes**





Horizontal rods combined with vertical wire ropes result in ideal training structures. Two different methods are available for attaching rods to wire ropes.

-  **1** • GreenGuide 90° cross clamp **No. 30920-0400-02** (Fig. 30.5, page 30)
-  **2** • Horizontal rod Ø 3.7 **No. 30922-0400-00** (Page 65)
-  **3** • Rope clip for stainless steel rods **No. 30920-0400-01** (Fig. 52.2, page 52)

 **S4 Rope type S4**
Rope S4 is supplied with a tensionable end connector and is intended for **on-site assembly** (rope types see page 25).

 **Wall mounting** on wood, hollow walls, concrete or external insulation. See installation principles and materials on pages 20 and 64.

 **P1** **Top/bottom mounting sections**
Depending on the load case, angle sections 40 / 40 / 4 or 30 / 30 / 4 are identical at the top and bottom.

 **P2** Intermediate section P2 can also be used as a bottom mounting section P3, depending on function and load case (see Fig. 34.3, page 34).

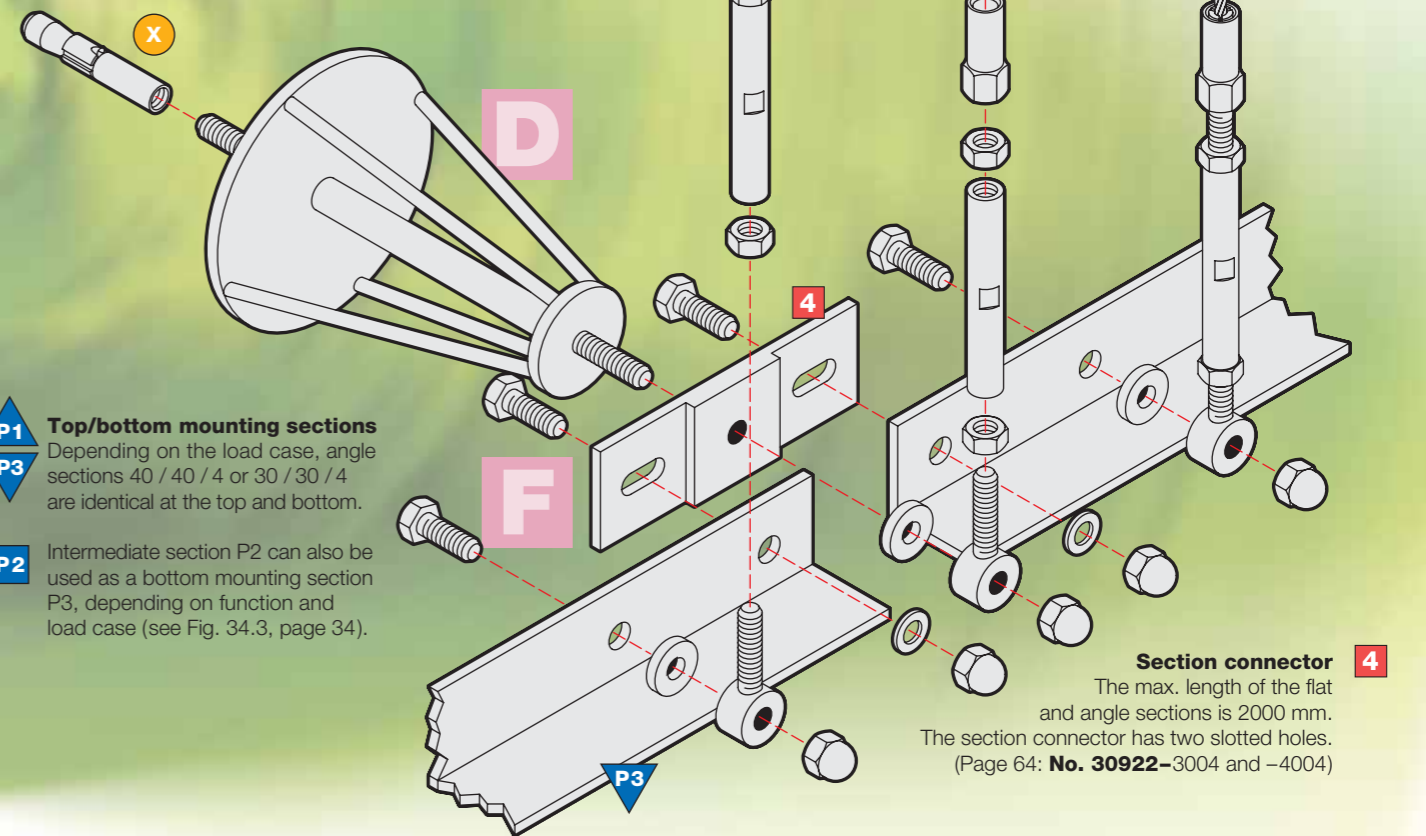

Section connector  **4**
The max. length of the flat and angle sections is 2000 mm. The section connector has two slotted holes. (Page 64: **No. 30922-3004** and **-4004**)

34.1 34.2

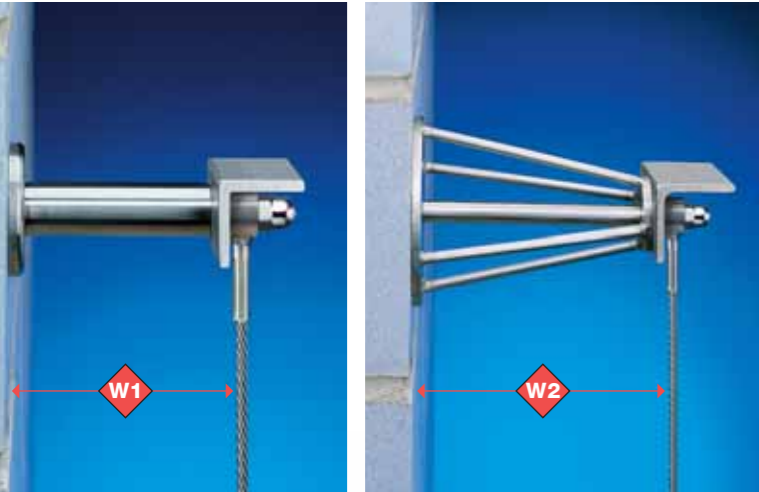

34.3



P2: Intermediate section for long ropes (see page 29)
P3: Bottom mounting section with clamped rope ends (see pages 29 and 54)

35.1



Ordering example (for the picture at right):

F5:

- P1 40/40/4
- P3 40/40/4
- B 900
- L 1200
- W2 160
- S4 4 pcs
- X 4 pcs



GREENGUIDE ROPE STYLE F5

For on-site assembly / Patent/DBGM pending / Material: ropes AISI 316, fittings AISI 316L
To order: see examples on opposite page

	a	b	c	d	Info: Page
P1 Upper mounting section	Angle 30/30/4	Angle 40/40/4			21, 29, 64
P2 Intermediate mounting section			Flat 30/4	Flat 40/4	21, 29, 64
P3 Bottom mounting section	Angle 30/30/4	Angle 40/40/4	Flat 30/4	Flat 40/4	21, 29, 64
B Max. width with 2 spacers	Suggested: approx. 1500 (with W 100 and plant weight 15 kg/m ²)				
L Max. length with 2 spacers	Suggested: approx. 3000 (with W 100 and plant weight 15 kg/m ²)				
W1 Wall clearance with spacer Ø 20/50	68 / 85 / 110 – see wall clearance table on pages				40/41
W2 Wall clearance with spacer Ø 40/100	85 / 110 / 160 / 210 – see wall clearance table on pages				40/41
S Possible rope types: S2 / S4	See notes on pages				25, 33
X Wall mounting on wood, hollow walls, concrete or external insulation. See installation principles and materials on pages					20, 64

P Mounting sections

On request, we will supply the stainless steel sections ready to install with all holes (according to binding drawings).

Horizontal rods combined with vertical wire ropes result in ideal training structures. See description on page 29 and the figure below (34.5).

! The load and design of a greening system depends on various factors. Please consult pages 18, 19 and 21 for details.

see page no.

34.4 34.5

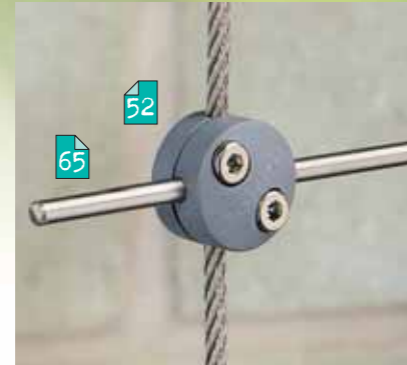

34.6



- L S2 S4

Assembled lengths for on-site assembly:

L always applies to the longest wire rope. Please see notes on page 25.



The user is responsible for choosing the correct assembly method (see Fig. 26.5 on page 26) and the proper rope diameter. **Functionality** is guaranteed only by Jakob rope No. 10820–0400 with the yellow code filament. Have a civil engineer check **strength values** and permissible loads on the basis of the given load case (see page 21).

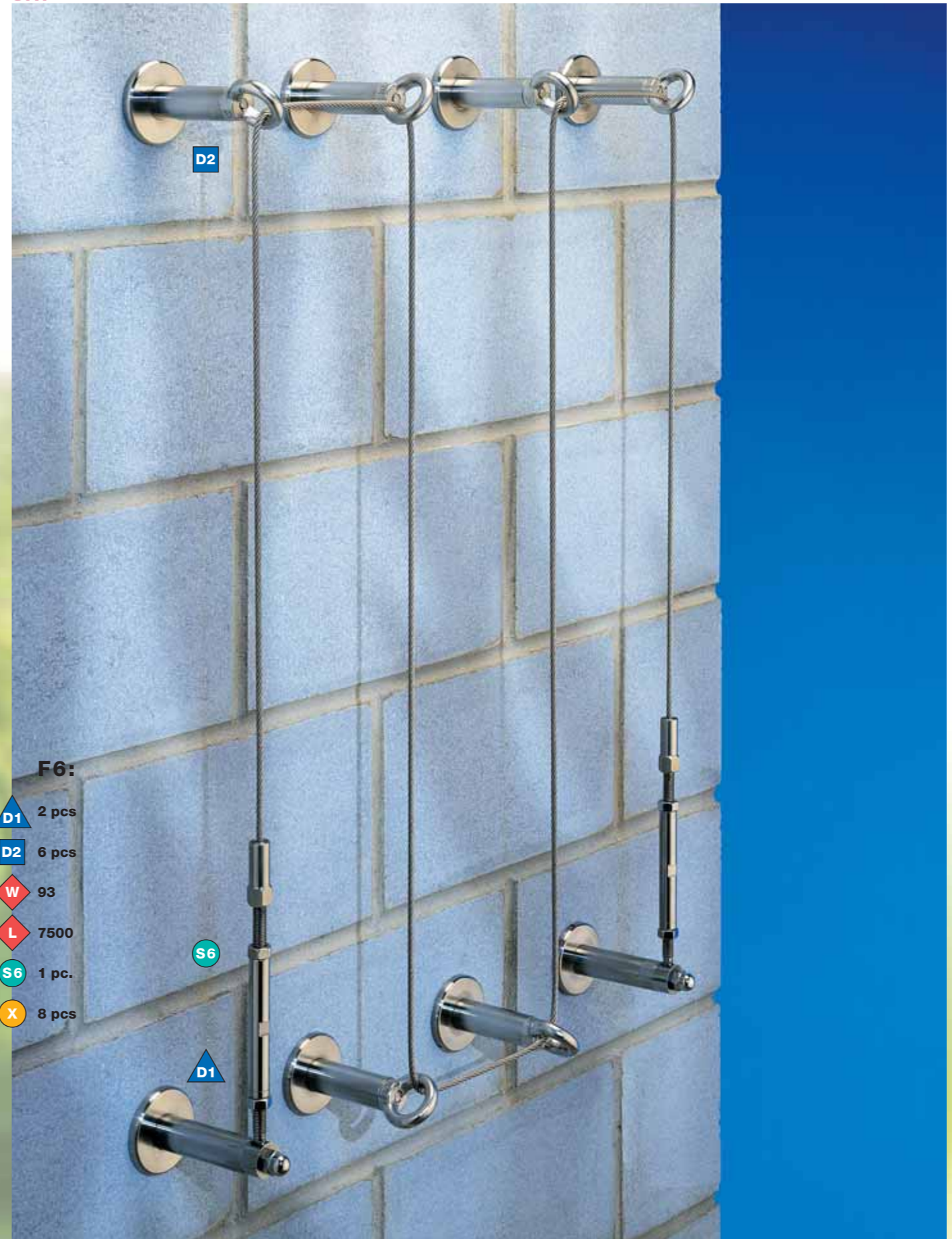
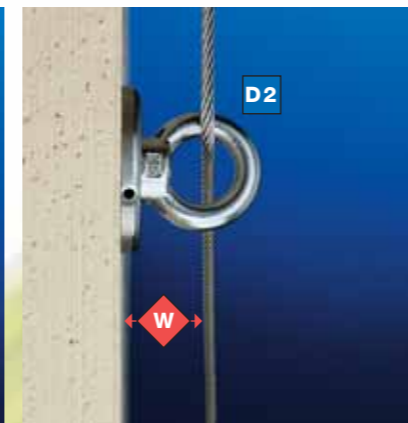
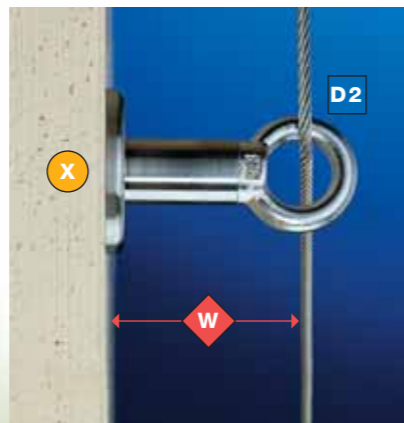
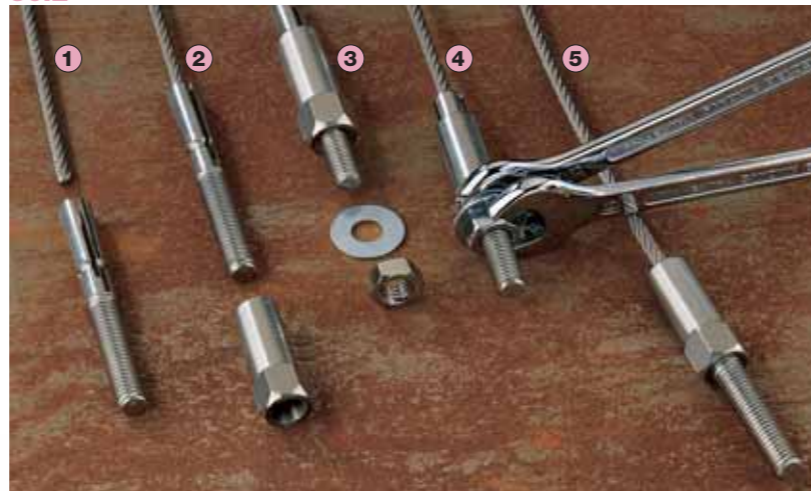

GREENGUIDE ROPE STYLE F6

For on-site assembly / Material: ropes AISI 316, fittings AISI 316L
To order: see examples on opposite page

		Info: Page
D1	GreenGuide spacer	Matches rope type S6 with GreenGuide eye 25, 49
D2	Intermediate spacer with ring nut	Rope guide or deflection point 48/49
D3	Spacer with ring nut	Loop of rope S7 is swaged directly to ring nut 48/49
W	Wall clearances	24 / 76 / 93 / 118 (D1 including 12 mm spacer washer) 40/41
L	Rope length (assembled length)	L = stretched rope with two assembled end connectors 25
S	Possible rope types: S6 / S7	See notes on pages 25
X	Wall mounting on wood, hollow walls, concrete or external insulation. See installation principles and materials on pages	20, 64

Ordering example (for the picture at right):

- F6:**
- D1** 2 pcs
 - D2** 6 pcs
 - W** 93
 - L** 7500
 - S6** 1 pc.
 - X** 8 pcs

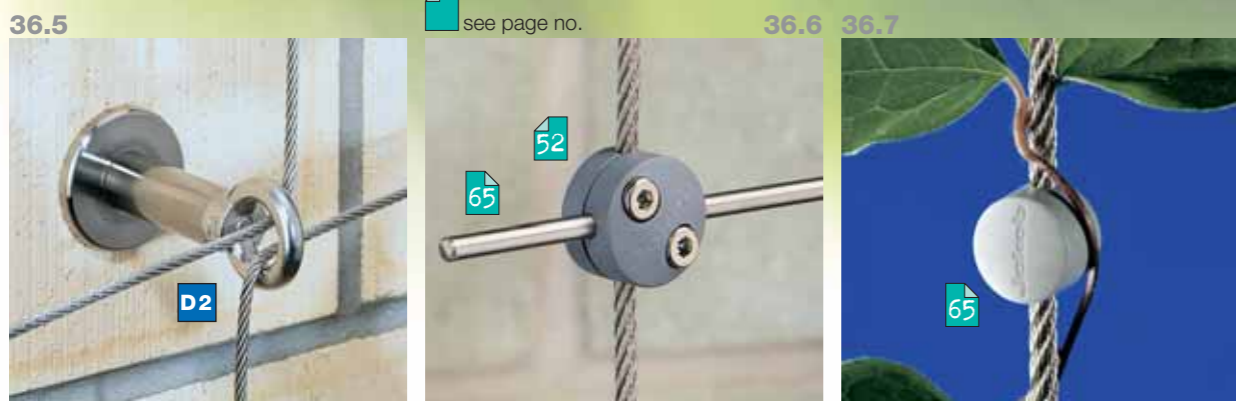

Assembled lengths for on-site assembly:
Please see notes on page 25.

D2 The sum of all deflections should not exceed 540°; max. 90° per deflection.



The user is responsible for choosing the correct assembly method (see Fig. 26.5 on page 26) and the proper rope diameter. **Functionality** is guaranteed only by Jakob rope No. 10820-0400 with the yellow code filament. Have a civil engineer check **strength values** and permissible loads on the basis of the given load case (see page 21).

38.1-38.4



SUPERB MATERIALS – EASY ASSEMBLY
THE SINGLE ROPE DIAMETER (4 MM)
AND ONE THREAD SIZE (M8) MAKE THIS
LINE ABSOLUTELY INTEROPERABLE

All parts of the **Jakob**® INOX LINE are made of top-quality materials.
**The two alloys used – AISI 316 (1.4401) and
AISI 316L (1.4404) – provide high corrosion resistance and
plant compatibility.**

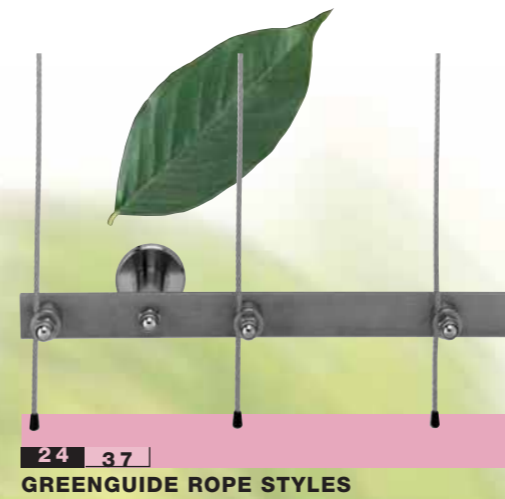

24 37
GREENGUIDE ROPE STYLES



44 45
STAINLESS STEEL ROPE / EXTERNAL THREADS



46 47
END STOP / EYES / LOOPS



48 49
SPACERS

50 51
WEBNET / SPACERS



50 51
SPACERS



52 53
CROSS CLAMPS

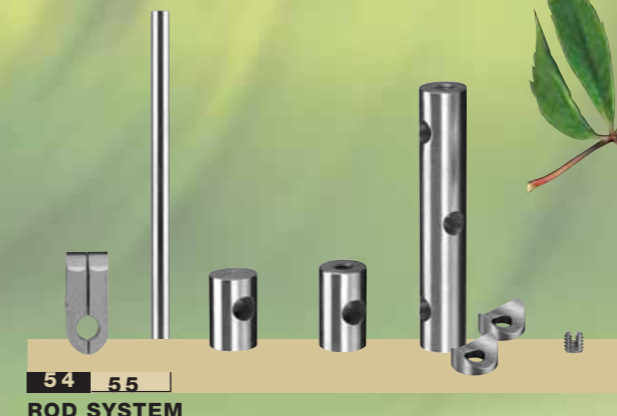

54 55
ROD SYSTEM



56 57
TRELLISWORK

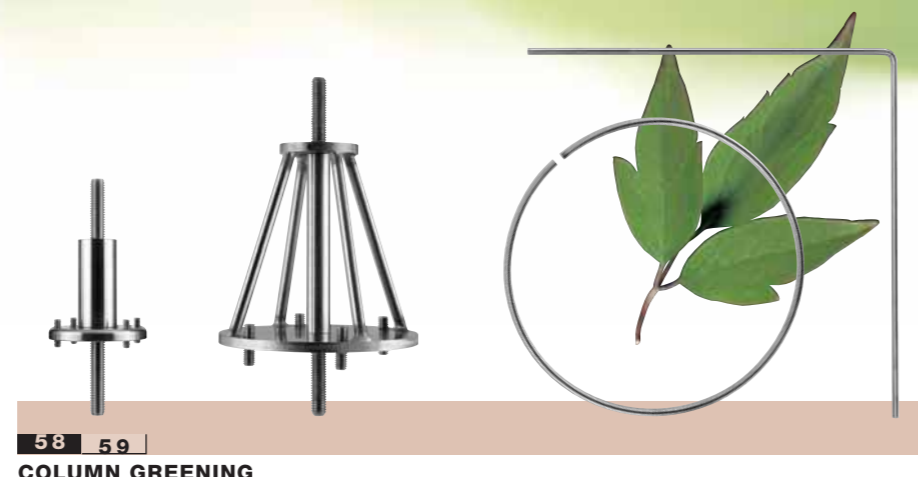

58 59
COLUMN GREENING

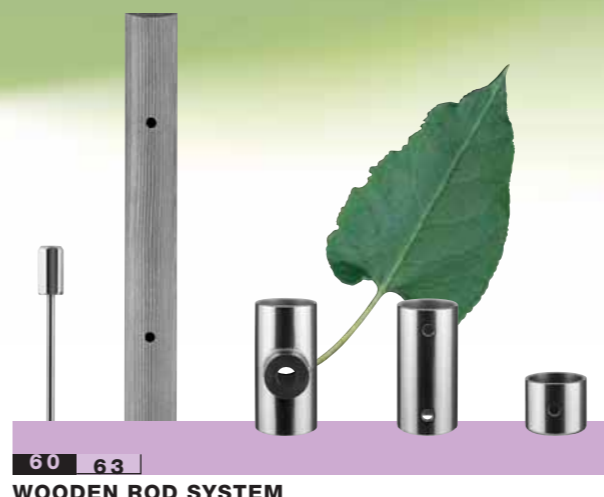

60 63
WOODEN ROD SYSTEM



64 65
SECTIONS / ASSEMBLY AIDS

40.1-40.4



40.5



Wall clearance (W) means the distance between the façade and the training system (centre of rope).

WALL CLEARANCE EXAMPLES

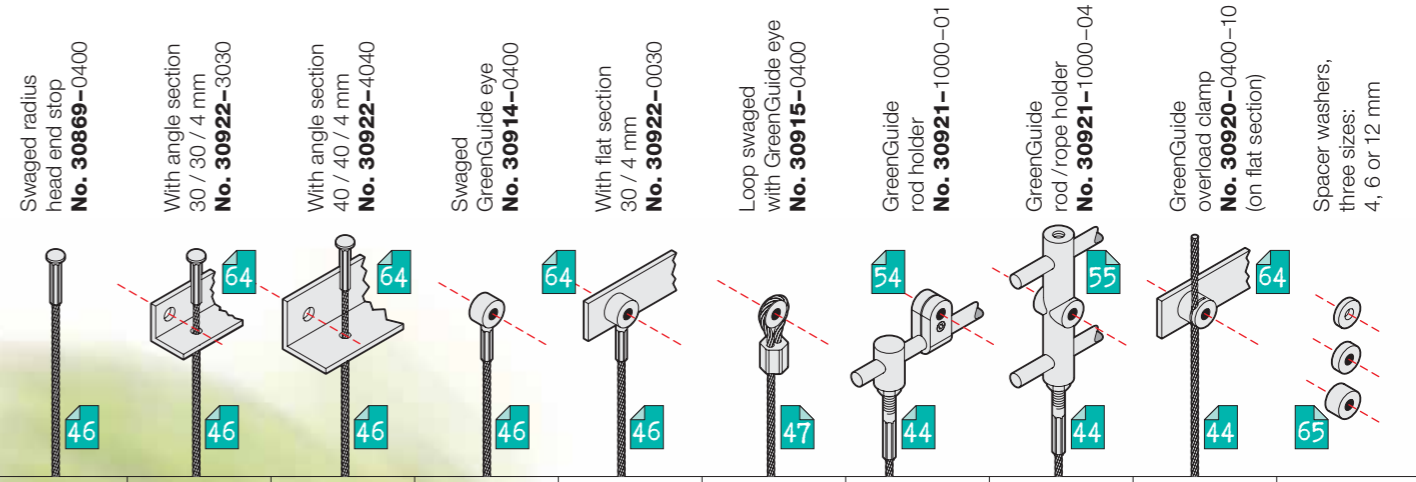

	Swaged radius head end stop No. 30869-0400	With angle section 30 / 30 / 4 mm No. 30922-3030	With angle section 40 / 40 / 4 mm No. 30922-4040	Swaged GreenGuide eye No. 30914-0400	With flat section 30 / 4 mm No. 30922-0030	Loop swaged with GreenGuide eye No. 30915-0400	GreenGuide rod holder No. 30921-1000-01	GreenGuide rod / rope holder No. 30921-1000-04	GreenGuide overload clamp No. 30920-0400-10 (on flat section)	Spacer washers, three sizes: 4, 6 or 12 mm
Eye bolt, slotted, with support washer No. 30836-0044-01 Unslotted No. 30836-0044	44									
Eye bolt, slotted, with support washer No. 30836-0064-01 Unslotted No. 30836-0064	64									
Eye bolt, slotted, with support washer No. 30836-0084-01 Unslotted No. 30836-0084	84									
GreenGuide spacer Ø 20 / 50 No. 30919-0058		74	80	64	68	61	68	71	74	
GreenGuide spacer Ø 20 / 50 No. 30919-0075		91	97	81	85	78	85	88	91	
GreenGuide spacer Ø 20 / 50 No. 30919-0100		116	122	106	110	103	110	113	116	
Spacer basket Ø 40 / 100 No. 30897-0075		91	97	81	85		85	88	91	
Spacer basket Ø 40 / 100 No. 30897-0100		116	122	106	110		110	113	116	
Spacer basket Ø 40 / 100 No. 30897-0150		166	172	156	160		160	163	166	
Spacer basket Ø 40 / 100 No. 30897-0200		216	222	206	210		210	213	216	
										+ 12 No. 30922-0800
										+ 6 No. 30922-0800-01
										+ 4 No. 30922-0800-02



see page no.

- 51 **1 Spacer basket Ø 40/100**
with four different
wall clearances
- 46 **2 Swaged GreenGuide eye**
for rope Ø 4 mm
(dome nut M8, p. 65)
- 64 **3 Angle section**
in two sizes:
30/30/4 or 40/40/4 mm
- 46 **4 Swaged radius head
end stop**
for rope Ø 4 mm
- 65 **5 Climber stud**
UV-resistant plastic
Colour grey
- 52 **6 GreenGuide cross clamp 90°**
UV-resistant plastic
Colour grey
- 52 **7 Rope clip for stainless steel rod**
UV-resistant plastic
Colour grey
- 62 **8 End cap**
for wooden rod Ø 25 mm
- 49 **9 GreenGuide spacer
Ø 20/50**
with three wall clearances
- 62 **10 Wooden rod holder**
incl. special Mininut
for wooden rod Ø 25 mm
- 65 **11 Horizontal rod Ø 3.7**
for combinations
with vertical ropes
- 63 **12 Wooden rod Ø 25**
glazed spruce (grey)
or untreated larch
- 62 **13 Wooden rod holder**
accepts rope guide point
- 65 **14 GreenGuide
overload clamp**
as a rope guide point
- 44 **15 Stainless steel rope Ø 4**
Construction 6x7+SE
- 47 **16 Turnbuckle with
GreenGuide eye LT2**
for on-site assembly

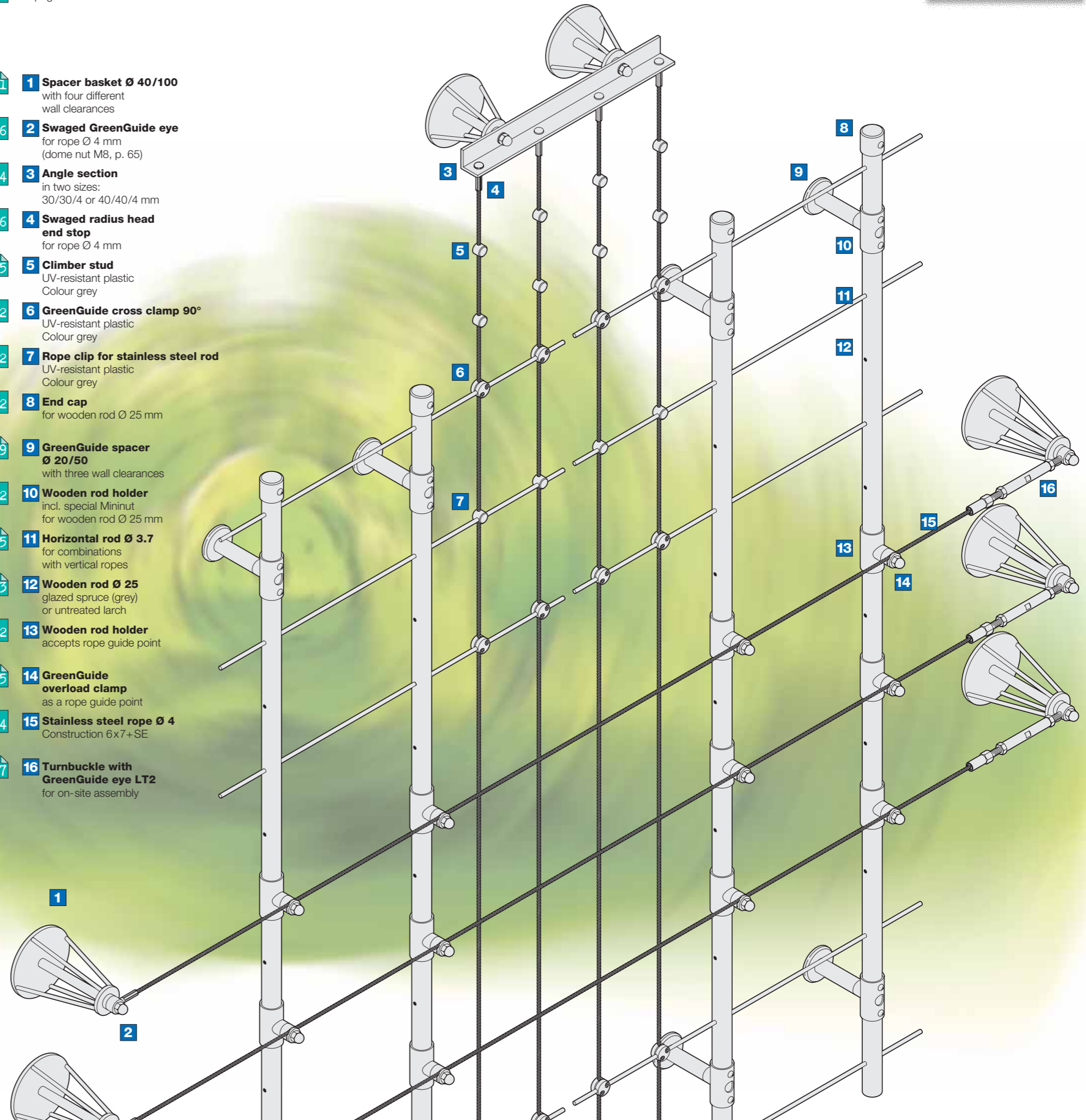

44.1 44.2



45.1

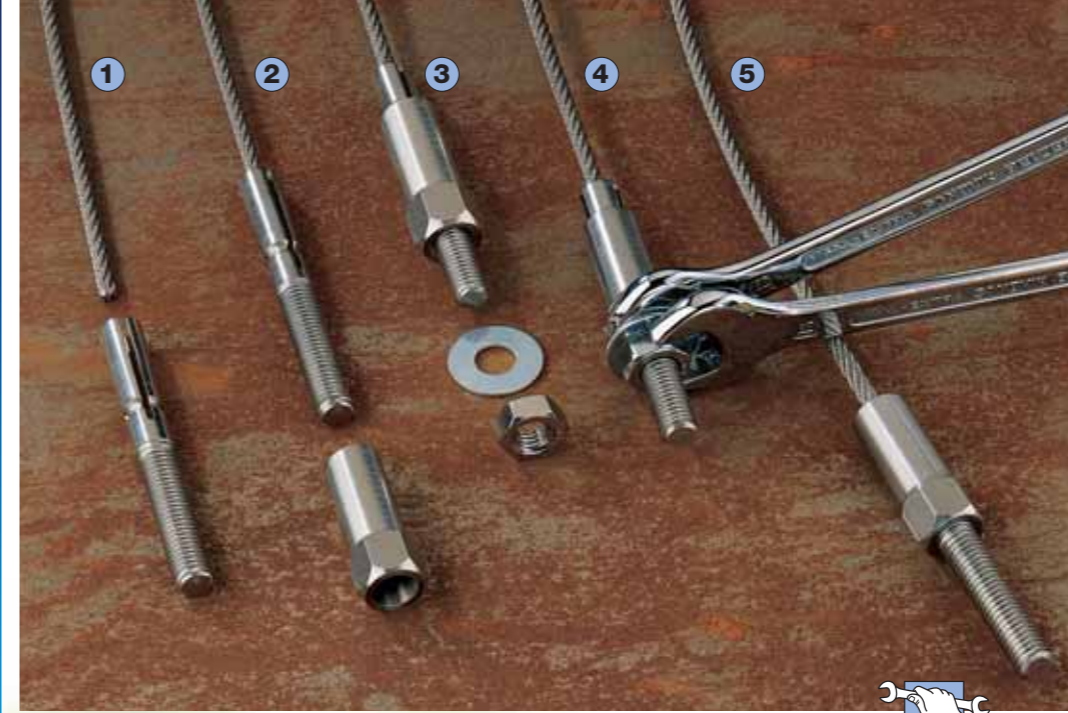

For on-site assembly

The user is responsible for choosing the correct assembly method and the proper rope diameter. **Functionality** is guaranteed only by Jakob rope No. 10820-0400 with the yellow code filament.

Tensioning range information: both thread ends are screwed halfway into the turnbuckle body.

= make longer (relax)
 = make shorter (tension)

Swaged external thread
 The swaging process **lengthens** dimension **b** by about 3%.

R Right-hand thread
L Left-hand thread

We assemble all end connectors with wire ropes that are **manufactured in-house**. Jakob® wire ropes are subject to strict quality inspections. All components are carefully matched. This assures superior functionality and **compliance with guaranteed breaking loads**. For safety reasons, use only Jakob® wire ropes in combination with items designed for **on-site assembly**. See description on page 21.

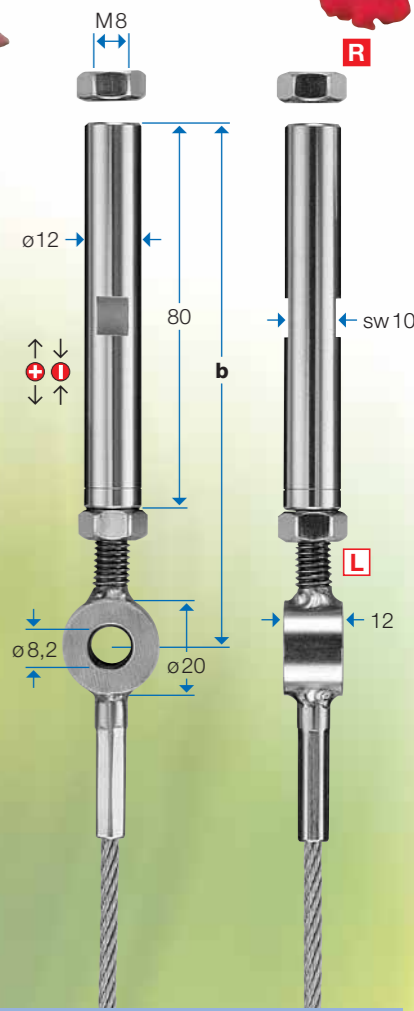
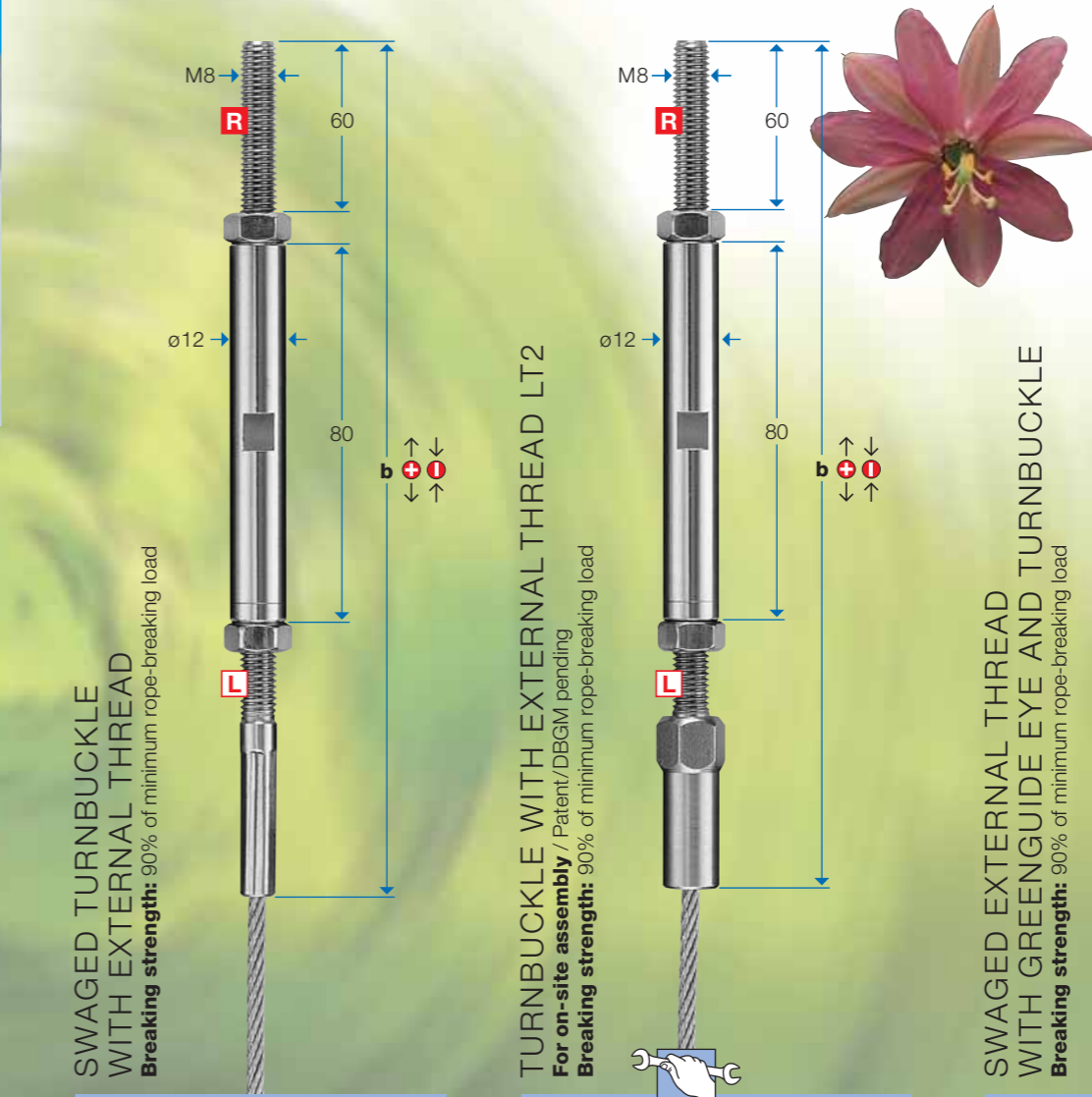

STAINLESS STEEL ROPE Ø 4 / 6x7+SE
 Minimum breaking load: 9,1 kN (kN x 102 = kp)

WIRE ROPE END CAP
 Soft plastic, colour black

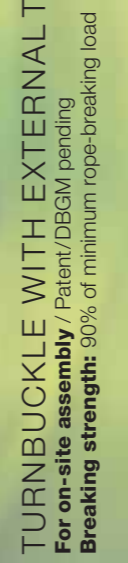
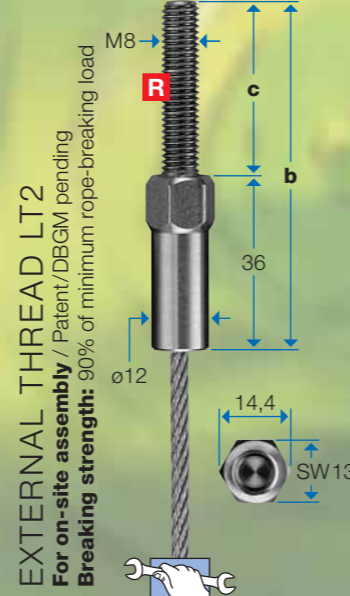
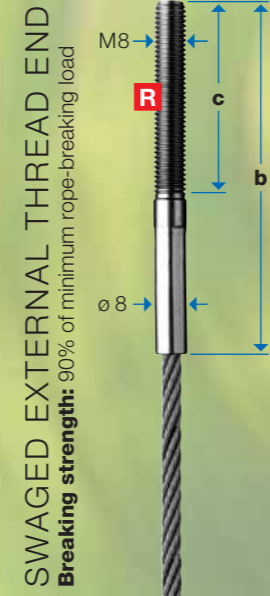

No. 10820-	1.4401 / AISI 316
0400	

No. 30804-	
0400	

No. 30740-	
0500	

No. 30850-	b	c	1.4404 / AISI 316
0400-031	67	30	
0400-062	97	60	
0400-081	117	80	

No. 30910-	b	c	1.4404 / AISI 316
0400-30	66	30	
0400-60	96	60	

No. 30911-	b	1.4404 / AISI 316
0400-01	197,5	
	Tension range:	
	lengthen + 8	
	shorten -24	

No. 30911-	b	1.4404 / AISI 316
0400-02	197,5	
	Tension range:	
	lengthen + 8	
	shorten -24	

No. 30911-	b	1.4404 / AISI 316
0400-03	108	
	Tension range:	
	lengthen + 4	
	shorten -12	

Technical data subject to change. All rights reserved. © 1985/02 by Jakob AG Switzerland, Rev.1



47.3

⊕ ⊖ **Tensioning range** information:
both thread ends are screwed halfway into the turnbuckle body.

← ⊕ → = make longer (relax)
→ ⊖ ← = make shorter (tension)

R Right-hand thread
L Left-hand thread



SWAGED RADIUS HEAD
END STOPS

Breaking strength: 90% of minimum rope-breaking load

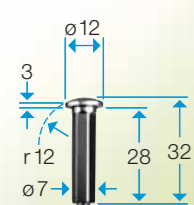

SWAGED GREENGUIDE EYE

Breaking strength: 90% of minimum rope-breaking load

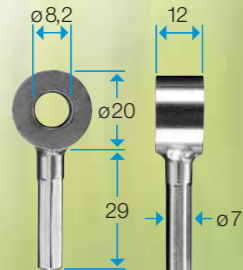

Swaged parts:
The swaging process **lengthens** the compression sleeve by about 3%.

S Without thimble
t With thimble



COMPRESSED LOOP

Breaking strength: 90% of minimum rope-breaking load

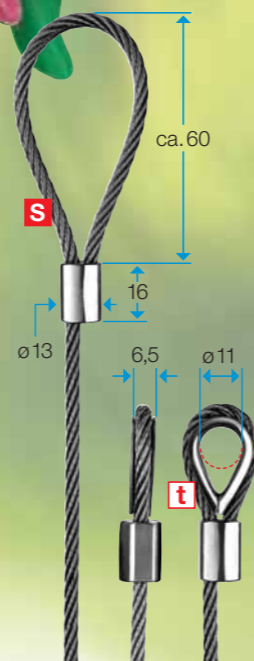

WELDED
WIRE ROPE END

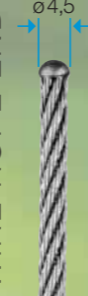

The user is responsible for choosing **the correct assembly method** and the proper rope diameter. **Functionality** is guaranteed only by Jakob rope No. 10820-0400 with the yellow code filament.

LIGHT LOOP CLAMP

Breaking strength: 90% of min. rope-breaking load

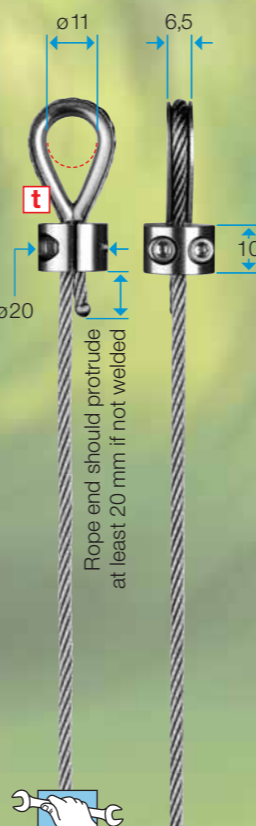

Rope end should protrude at least 20 mm if not welded

SWAGED LOOP WITH GREENGUIDE EYE

Breaking strength: 90% of min. rope-breaking load



TURNBUCKLE WITH GREENGUIDE EYE LT2

For on-site assembly / Patent/DBGM pending

Breaking strength: 90% of minimum rope-breaking load

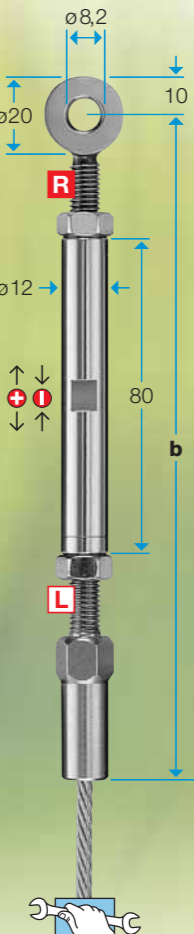

TURNBUCKLE WITH SWAGED GREENGUIDE EYE

Breaking strength: 90% of minimum rope-breaking load

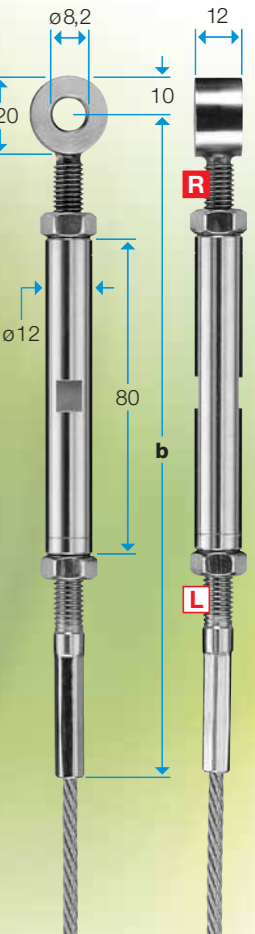

No. 30869-0400

1.4404 / AISI 316

No. 30914-0400

1.4404 / AISI 316

No. 20803-0400 without thimble

No. 20804-0400 with thimble

1.4404 / AISI 316

No. 30905-0400

1.4401 / AISI 316

No. 30874-0400-01

1.4404 / AISI 316

No. 30915-0400

1.4404 / AISI 316

No. 30911-0400-04
156
Tension range: +8 -24

1.4404 / AISI 316

No. 30911-0400-05
156
Tension range: +8 -24

1.4404 / AISI 316

48.1 48.2



49.1

GREENGUIDE ROPE GUIDE

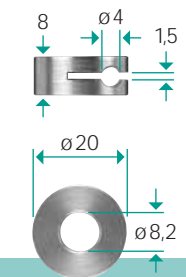

No. 30920-0400-00

1.4404 / AISI 316

HOLE SAW



No. 30912-0044

RING NUT WITH SUPPORT WASHER

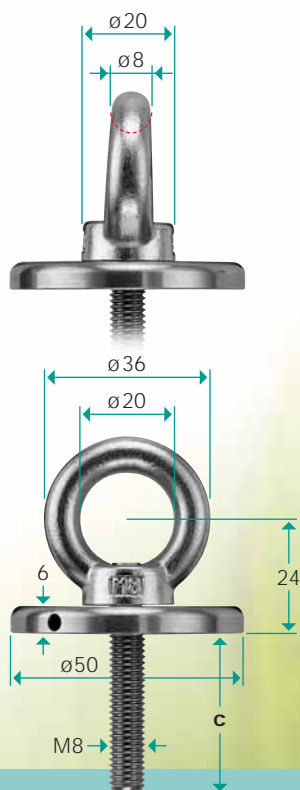

No. 30918-0800-01	c
	variable

1.4404 / AISI 316

EYE BOLT, SLOTTED WITH SUPPORT WASHER

Patent / DBGM pending



No. 30836-0044-01	b
	44
0064-01	64
0084-01	84

1.4404 / AISI 316

EYE BOLT WITH SUPPORT WASHER

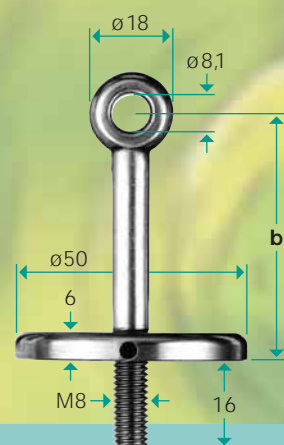

No. 30836-0044	b
	44
0064	64
0084	84

1.4404 / AISI 316



Threaded extender see page 51

SPACER Ø 12/24

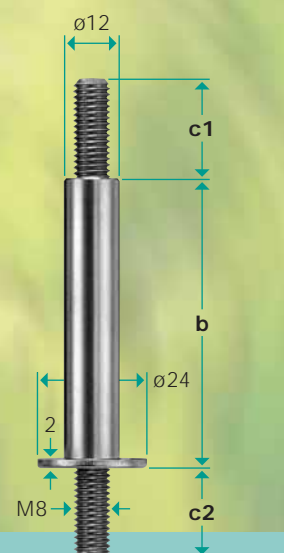

No. 30919-0800-01	b	c1/c2
	variable	variable

1.4404 / AISI 316

GREENGUIDE SPACER Ø 20/50

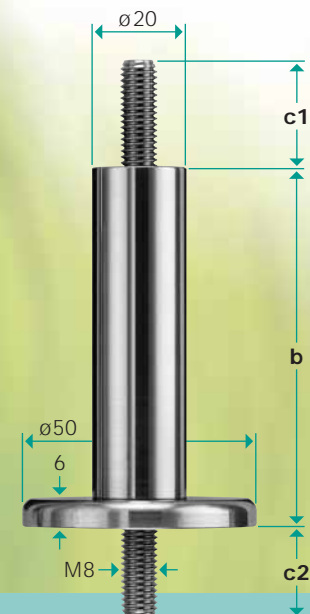

No. 30919-0058	b	c1/c2
	58	variable
0075	75	
0100	100	

1.4404 / AISI 316

SUPPORT TUBE POM (Delrin) black



No. 30919-0800-03	b
	variable

Costs per cut and drilling. No. 20800-0001



50.1



46

47

51.1 51.2



Curved mounting surface
see pages 58/59.



Correct wall mounting (see page 20) is the responsibility of the user. **Strength ratings** and permissible loads based on the application must be calculated by a qualified engineer (see page 21).

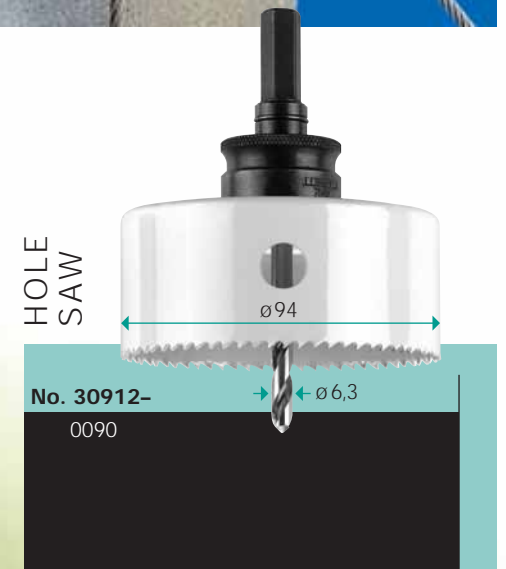

HOLE SAW

No. 30912-0090

WEBNET

This multifunctional mesh is made of stainless steel wire rope dimensioned to customer specifications. Please contact us for customised planning with WEBNET. Other rope Ø on request.

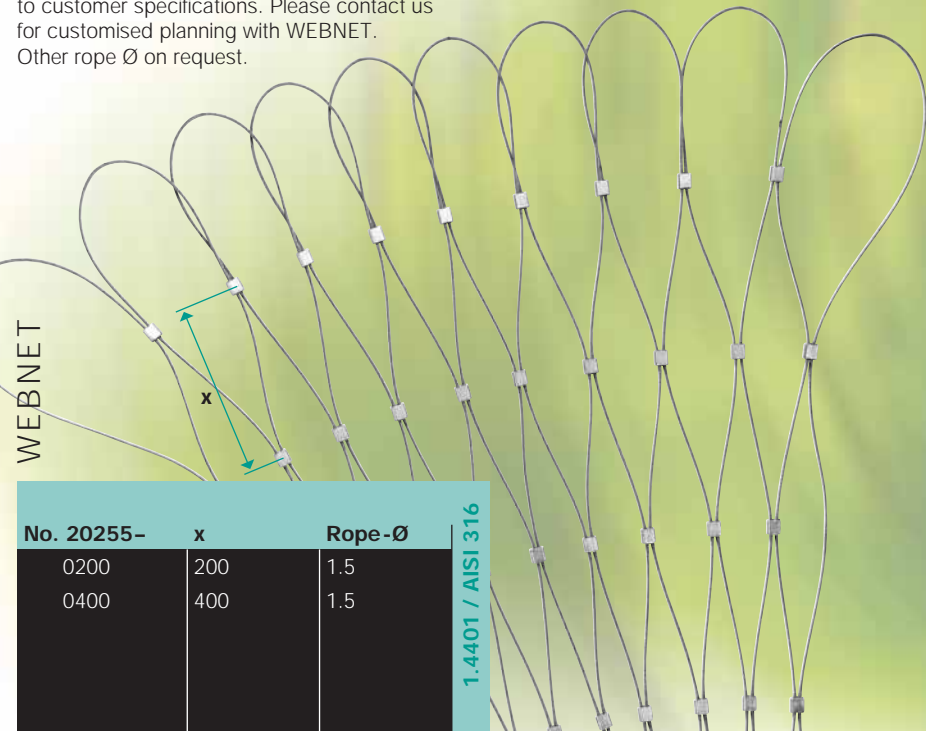

WEBNET

No. 20255-	x	Rope-Ø
0200	200	1.5
0400	400	1.5

1.4401 / AISI 316

SUPPORT WASHER WITH HEADLESS SCREW

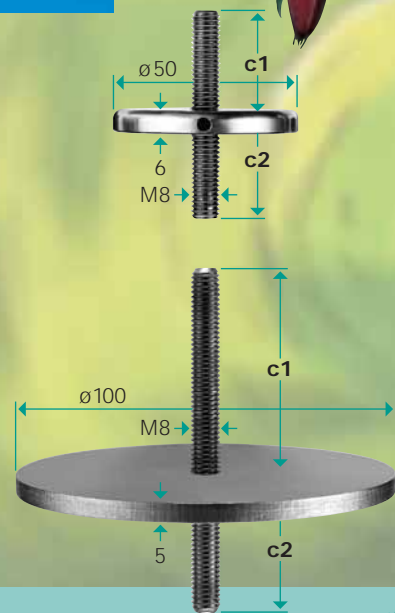

No. 30919-	Ø	c1/c2
0050-01	50	variable
0100-01	100	variable

1.4404 / AISI 316

SPACER BASKET Ø 40/100
European patent pending



No. 30897-	b	c1	c2
0075	75	variable	variable
0100	100		
0150	150		
0200	200		

1.4404 / AISI 316

THREADED EXTENDER

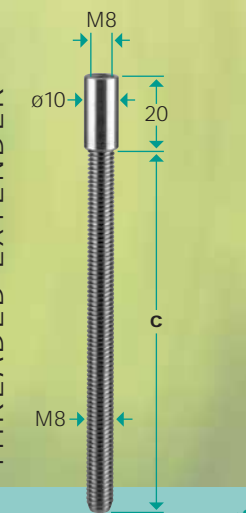

No. 30919-	c
0800-05	variable

1.4404 / AISI 316

Costs for cut and drilling: No. 30897-0020-01

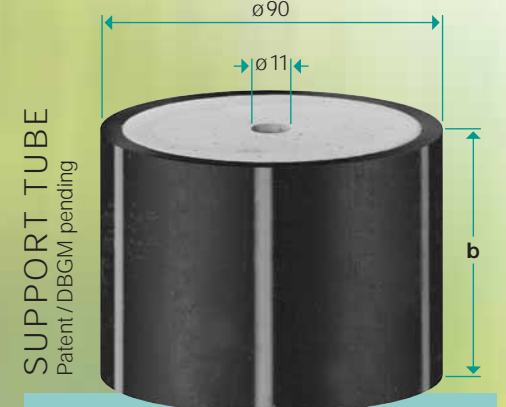

SUPPORT TUBE
Patent / DBGW pending

No. 30897-	b
0020-10 foam-filled	variable
0020-11 unfilled	variable

52.1 52.2

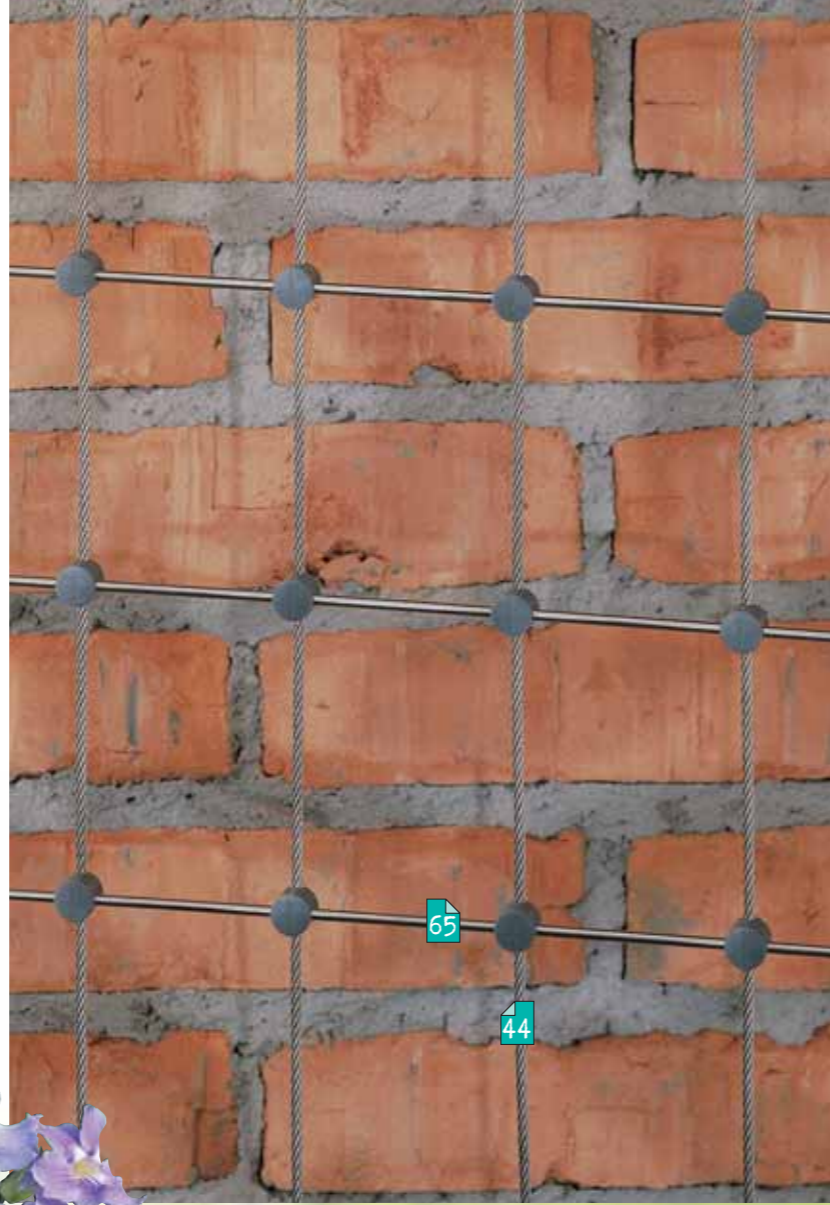

53.1

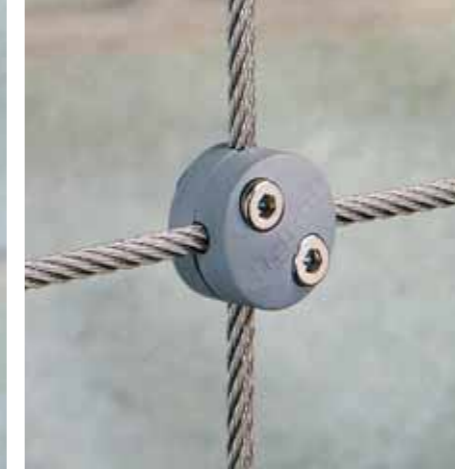

53.2 53.3



Adjustable cross clamp with support washer
This product may be used only as an intermediate rope guide (not as an end connector). Dimension **b1** corresponds to the distance between the wall and the inner wire rope.

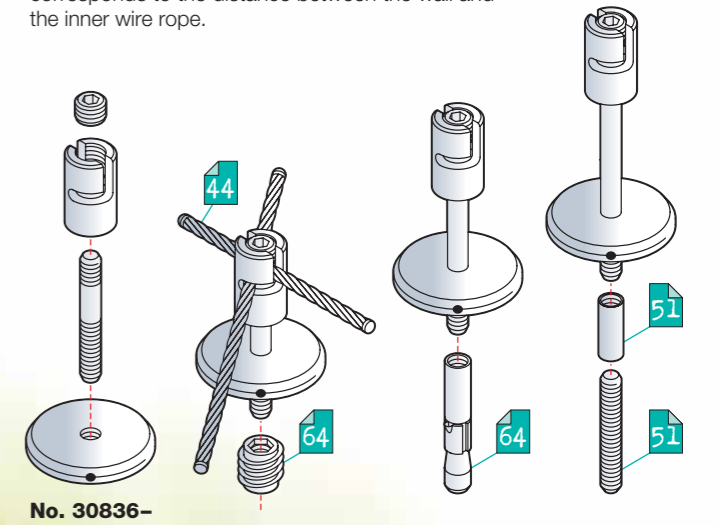

No. 30836-



The user is responsible for choosing the correct assembly method and the proper rope diameter.

ROPE CLIP FOR HORIZONTAL ROD Ø 3.7
UV-resistant plastic



No. 30920-
0400-01

GREENGUIDE CROSS CLAMP 90°
UV-resistant plastic

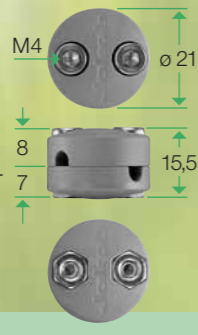

No. 30920-
0400-02

CROSS CLAMP 90°



No. 30858-
0400

1.4404 / AISI 316

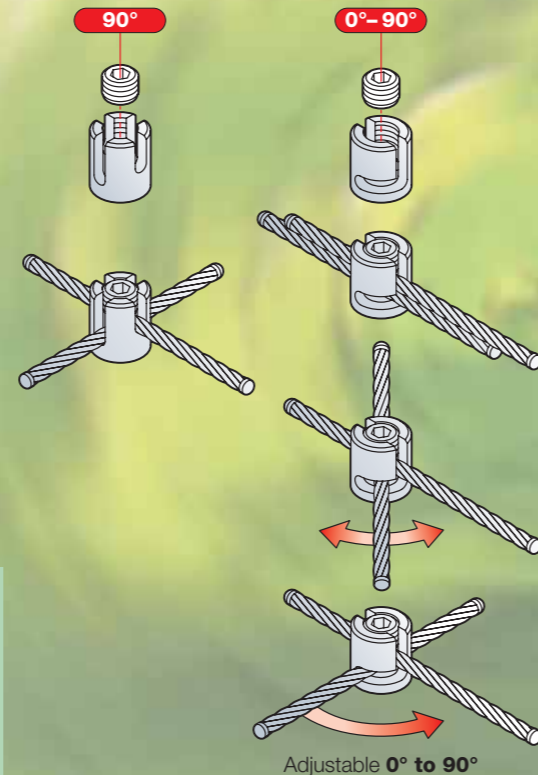

ADJUSTABLE CROSS CLAMP
Patent/DBGM pending

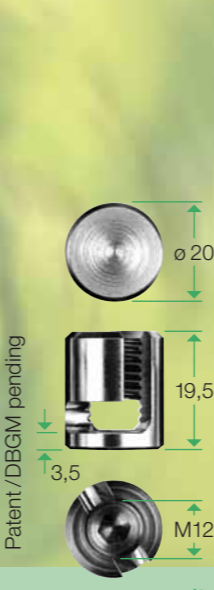

No. 30858-
0400-01

1.4404 / AISI 316

ADJUSTABLE CROSS CLAMP WITH INTERNAL THREAD
Patent/DBGM pending

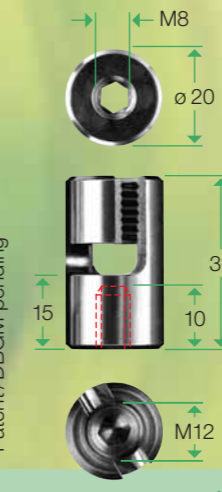

No. 30858-
0400-02

1.4404 / AISI 316

ADJUSTABLE CROSS CLAMP WITH SUPPORT WASHER
Patent/DBGM pending

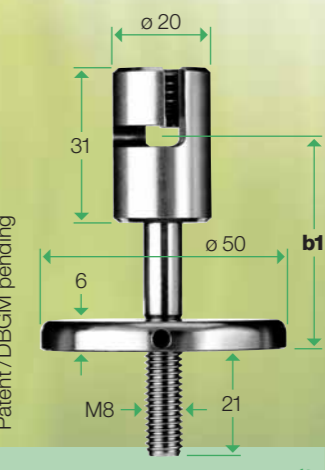

No. 30836-
0044-40
0064-40
0084-40

b1

44
64
84

1.4404 / AISI 316

GREENGUIDE ADJUSTABLE CROSS CLAMP

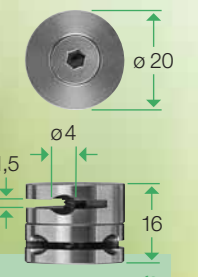

No. 30920-
0400-03

1.4404 / AISI 316



The user is responsible for choosing the correct assembly method. Strength ratings and permissible loads based on the application must be calculated by a qualified engineer (see page 21).

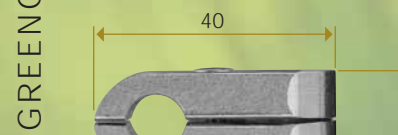
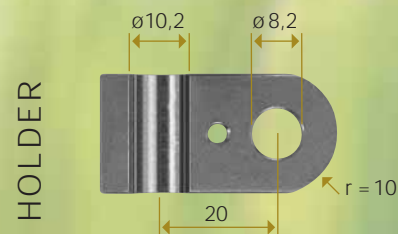

No. 30921-1000-01	1.4404 / AISI 316
-------------------	-------------------

GROUND STAINLESS STEEL ROD Ø 10

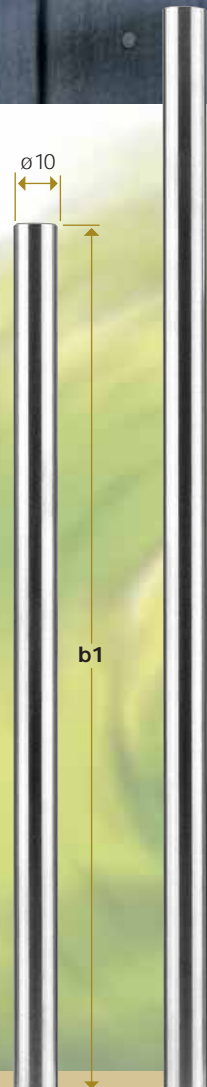

Costs per cut: No. 20800-0002

No. 30921-1000	b1	max. 2500	1.4404 / AISI 316
----------------	----	-----------	-------------------

1 Fig 54.2: The GreenGuide overload clamp (page 65) clamps the end of the wire rope. The defined clamping force of 1 kN allows the rope to slip when gripped by vigorously twining climbers, thus lengthening the rope (see page 19, item E).

ROD / ROPE CONNECTOR

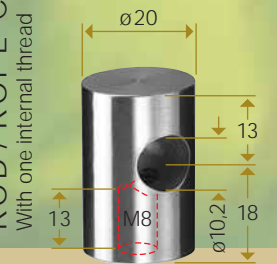

No. 30921-1000-02	1.4404 / AISI 316
-------------------	-------------------

ROD / ROPE CONNECTOR

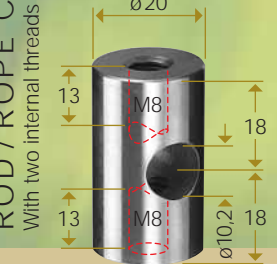

No. 30921-1000-03	1.4404 / AISI 316
-------------------	-------------------

GREENGUIDE ROD / ROPE HOLDER

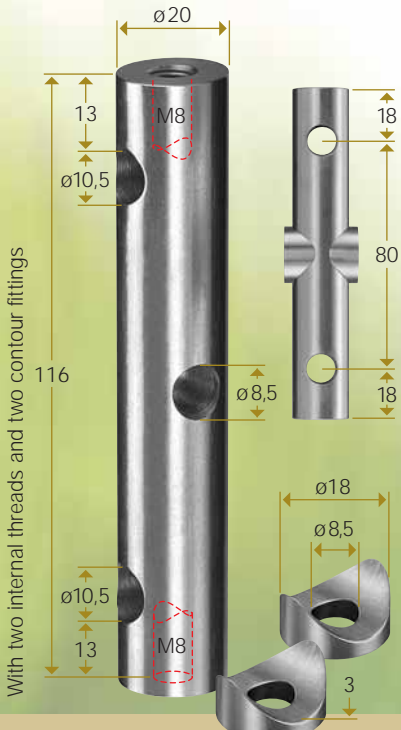

No. 30921-1000-04	1.4404 / AISI 316
-------------------	-------------------

ROD SETSCREW



No. 30921-0800	1.4404 / AISI 316
----------------	-------------------



56.1 56.2



57.1

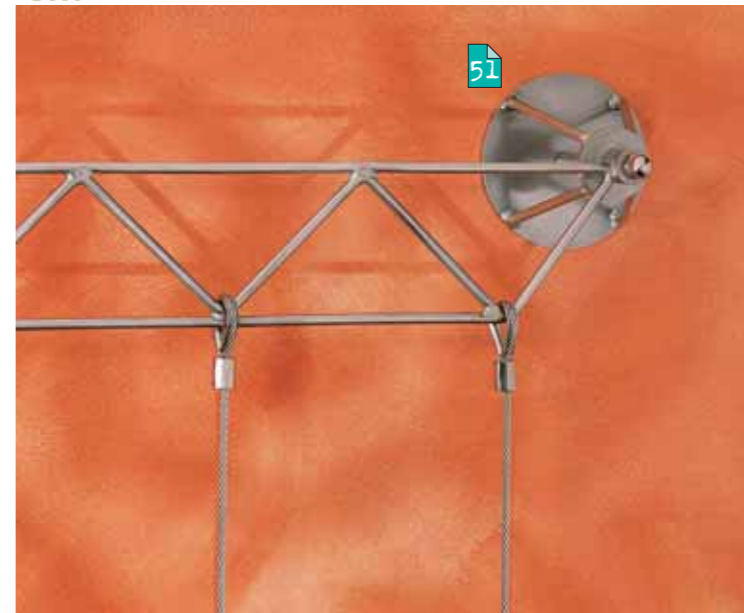

SPACER WASHER
For GreenGuide trelliswork

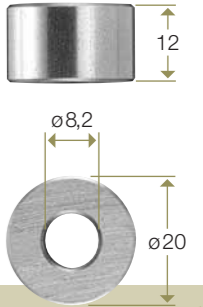

No. 30922-0800

1.4404 / AISI 316

GREENGUIDE TRELLIS-
WORK WITH
SWAGED LOOPS

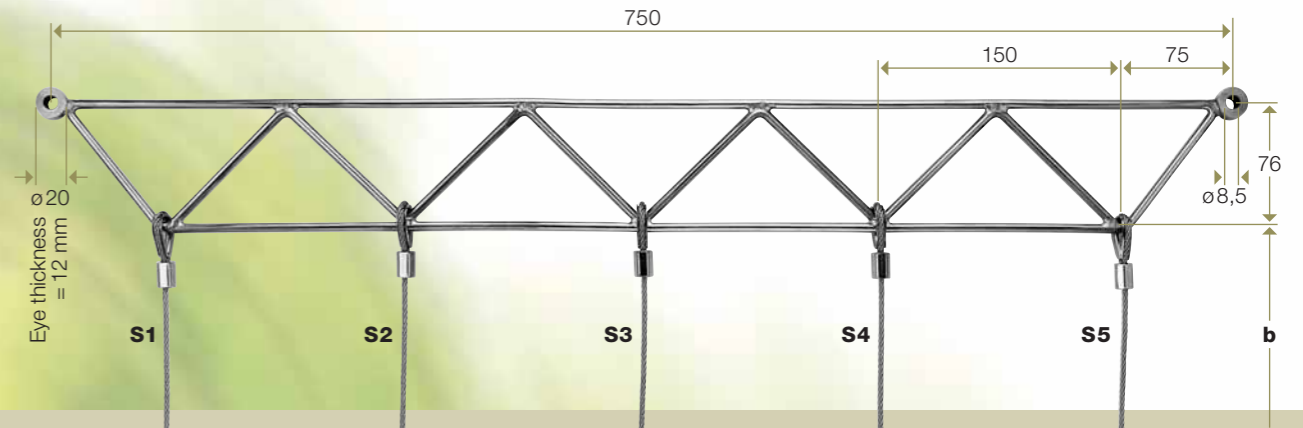

No. 30922-	b (rope length)	S (number of ropes)
0600-01	max. 6000	with 5 ropes (S1 / S2 / S3 / S4 / S5)
0600-03	max. 6000	with 3 ropes (S1 / S3 / S5)
0600		without ropes

1.4404 / AISI 316



The user is responsible for choosing the correct assembly method and the proper rope diameter. **Functionality** is guaranteed only by Jakob rope No. 10820-0400 with the yellow code filament. **Strength ratings** and permissible loads based on the application must be calculated by a qualified engineer (see page 21).

⊕ ⊖ Tensioning range information: both thread ends are screwed halfway into the turnbuckle body.

← ⊕ → = make longer (relax)
→ ⊖ ← = make shorter (tension)

R Right-hand thread
L Left-hand thread

GREENGUIDE TRELLIS-
WORK WITH
TENSIONER FITTINGS
For on-site assembly (without ropes)

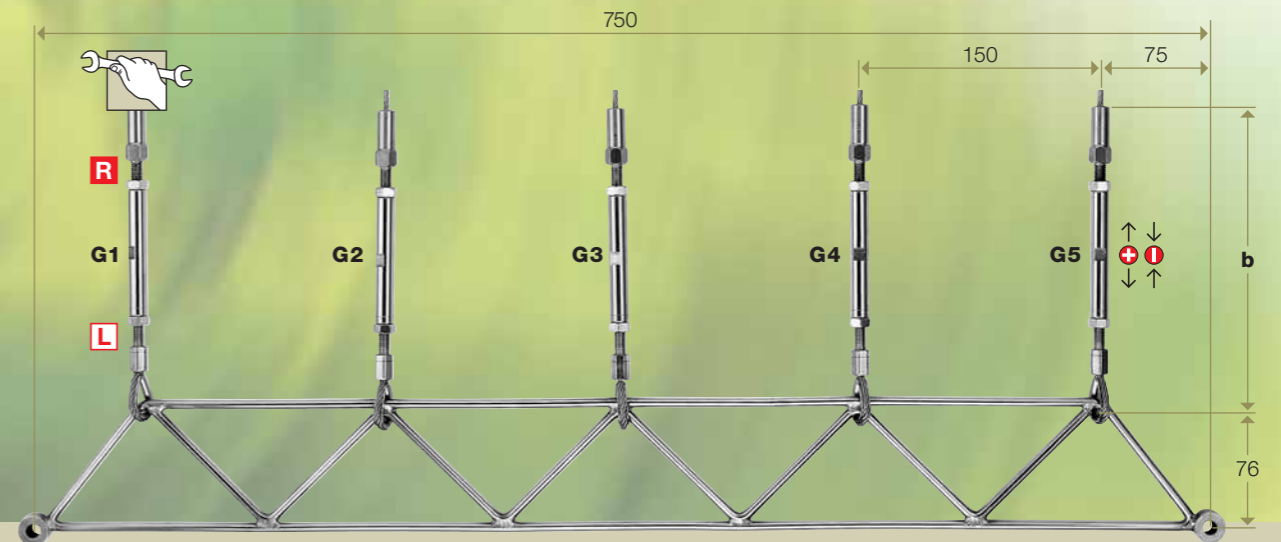

No. 30922-	G (number of tensioner fittings)	b
0600-02	with 5 tensioner fittings (G1 / G2 / G3 / G4 / G5)	200
0600-04	with 3 tensioner fittings (G1 / G3 / G5)	Tension range: lengthen +8 shorten -24

1.4404 / AISI 316

Technical data subject to change. All rights reserved. © 1988/99 by Jakob AG Switzerland.

58.1 58.3



58.2



patent pending

59.1 59.2



patent pending



patent pending

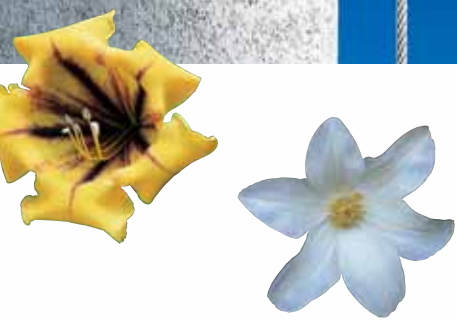

GREENGUIDE
SPACER Ø 20/50
For curved mounting surfaces

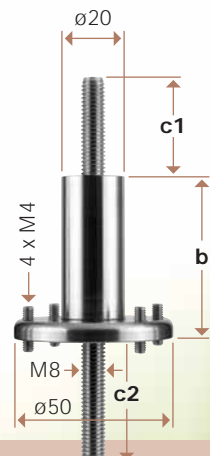

SPACER BASKET Ø 40/100
For curved mounting surfaces / European patent pending

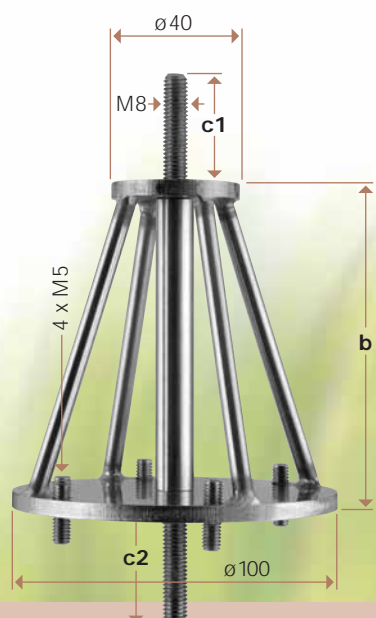

CIRCULAR ROD Ø 3.7

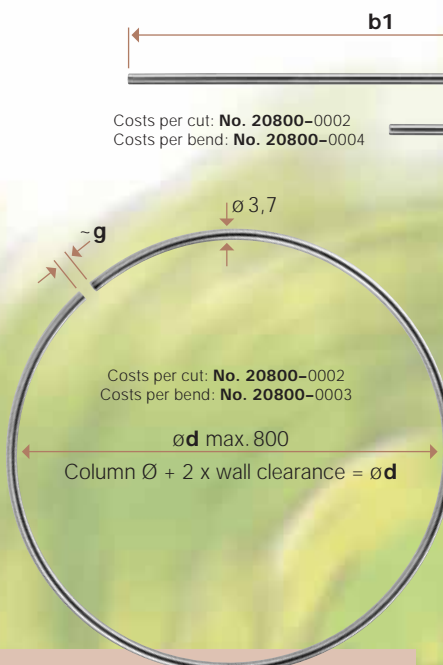

Costs per cut: No. 20800-0002
Costs per bend: No. 20800-0004

Costs per cut: No. 20800-0002
Costs per bend: No. 20800-0003

ANGLED ROD Ø 3.7

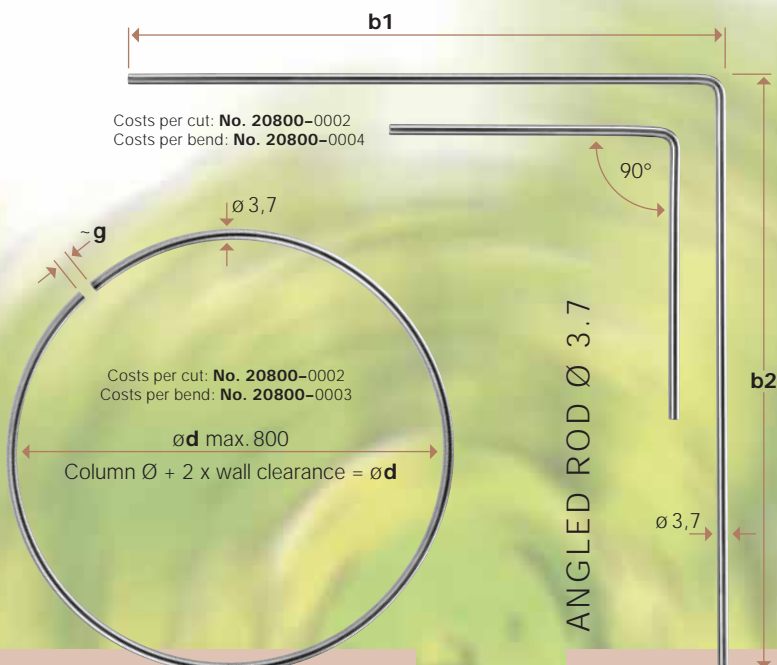

No. 30919-	b	c1/c2
0058-02	58	variable
0075-02	75	variable
0100-02	100	variable

1.4404 / AISI 316

No. 30897-	b	c1/c2
0075-01	75	variable
0100-01	100	variable
0150-01	150	variable
0200-01	200	variable

1.4404 / AISI 316

No. 30922-	ød	g
0400-01	variable	approx. 10
	max. 800	

1.4404 / AISI 316

No. 30922-	b1 / b2
0400-02	variable
	b1 + b2 = max. 1000

1.4404 / AISI 316

The user is responsible for choosing the correct assembly method (see page 20).
Strength ratings and permissible loads based on the application must be calculated by a qualified engineer (see page 21).



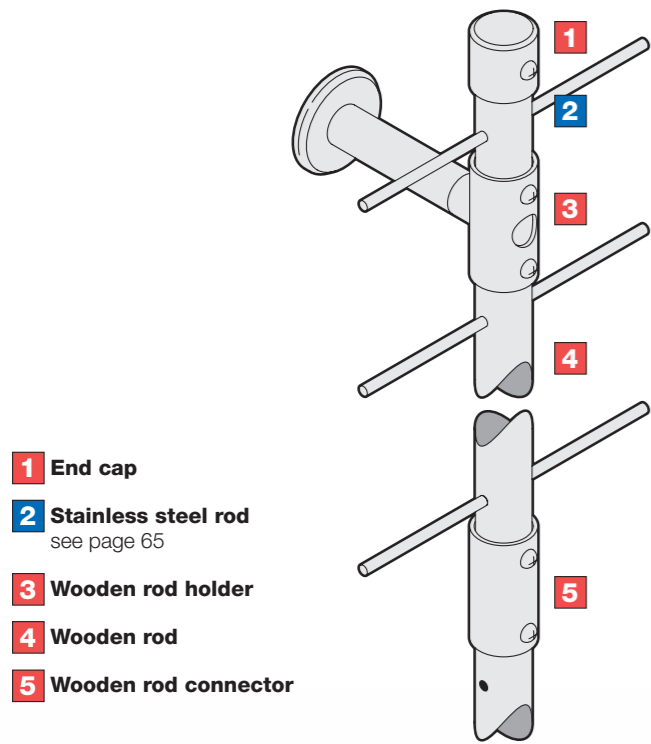

- 1** End cap
- 2** Stainless steel rod
see page 65
- 3** Wooden rod holder
- 4** Wooden rod
- 5** Wooden rod connector

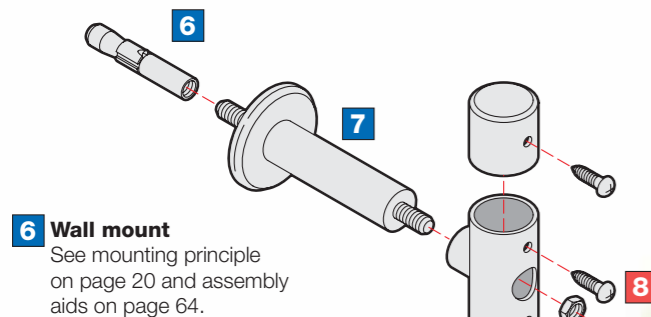
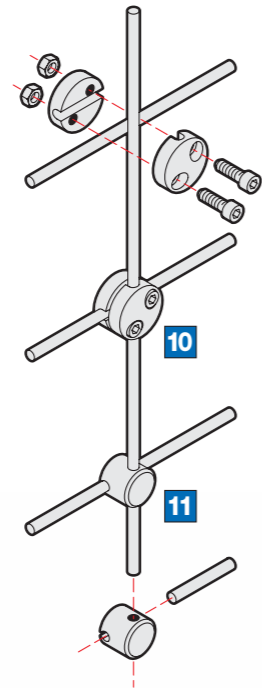

- 6** Wall mount
See mounting principle
on page 20 and assembly
aids on page 64.
- 7** Spacer
Depending on load
and desired wall clearance
(see pages 49 and 51).
- 8** Radiused head screws
with special Mininut
contained in the scope
of delivery of wooden rod
fittings.

- 9** Hammer pins
are available for all
wooden rod fittings
in place of radiused
head screws.
Caution: hammer
pins cannot be
removed once
installed!

- 10** GreenGuide cross clamp
see page 52

- 11** Rope clip for
stainless steel rod
see page 52

- 10** GreenGuide cross clamp
see page 52

- 11** Rope clip for
stainless steel rod
see page 52





62.1 62.2



62.3

63.1 - 63.4 63.5



63.6

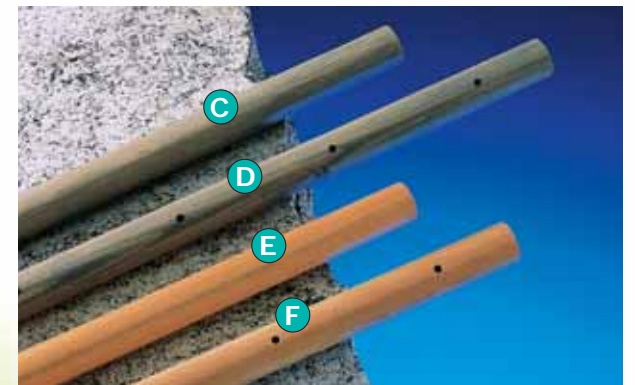

63.7

END CAP
For wooden rod

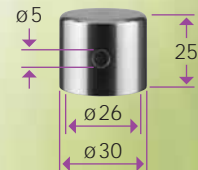

No. 30923-
0003-01
0003-02

1.4404 / AISI 316

WOODEN ROD HOLDER
With special Mininut

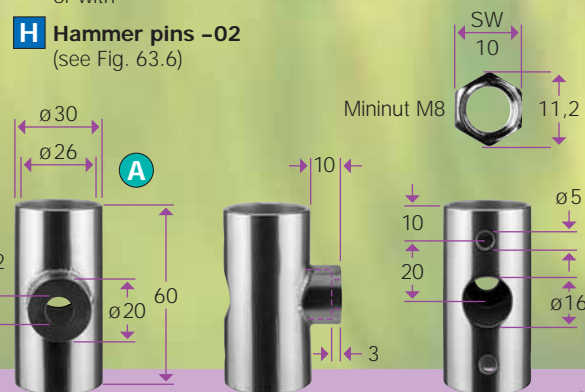

No. 30923-
0001-01
0001-02

with radiused head screws (-01)
with hammer pins (-02)

1.4404 / AISI 316

WOODEN ROD CONNECTOR

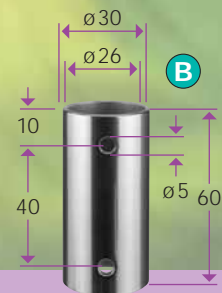

No. 30923-
0002-01
0002-02

1.4404 / AISI 316

Wooden rod fittings are available with

- L** Radiused head screws -01 or with
- H** Hammer pins -02 (see Fig. 63.6)

Possible wall clearances (max. lateral force see page 21)

Spacer basket Ø 40/100 (page 51):
W = 100 / 125 / 175 / 225 mm

Spacer Ø 20/50 (page 49):
W = 83 / 100 / 125 mm

Spacer Ø 12/24 (page 49):
W = variable, max. 80 mm

Support washer Ø 50 (page 50):
W = 31 mm

SWAGED END STOP
For stainless steel rod

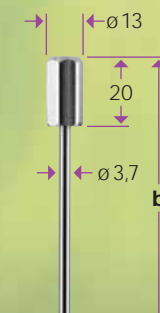

No. 30923-	b
0004	max. 2000

1.4404 / AISI 316

WOODEN ROD

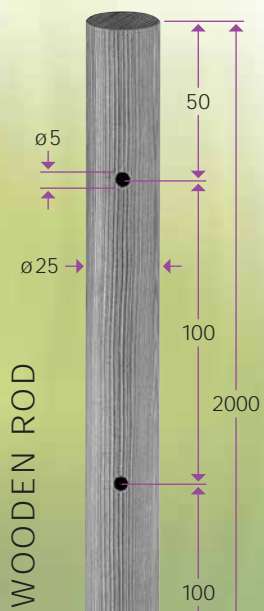

Costs per cut:
No. 20800-0002

- C** Spruce glazed, grey, not drilled
- D** Spruce glazed, grey, drilled
- E** Larch untreated, not drilled
- F** Larch untreated, drilled

No. 30923-	Fig.
0006	C
0007	D
0008	E
0009	F

R Right-hand thread

BOLT ANCHOR

With internal thread high-strength steel, galvanized with stainless steel spreader suitable only for concrete

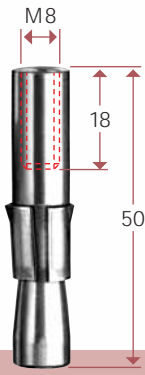

No. 30803-0800-02

TVM MORTAR SH PERFORATED ANCHOR

For hollow and solid walls

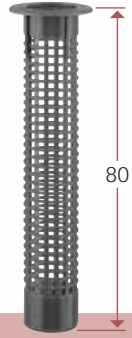

No. 30803-0800-05
Mastic gun: 0800-051

RAMPA SCREW-IN NUT FOR WOOD

Galvanized steel with hexagon socket Type SK

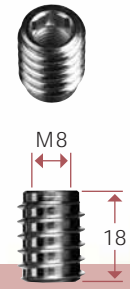

No. 30803-0800-04

~ DIN 7965

EYE BOLT WITH WASHER

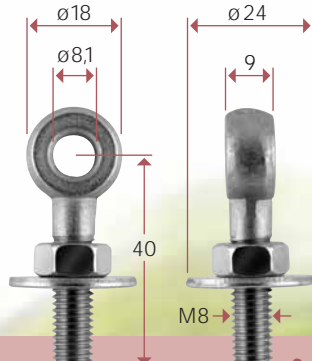

No. 30888-0800-05

1.4404 / AISI 316

R Right-hand thread

HEXAGON HEAD CAP SCREW

DIN 933

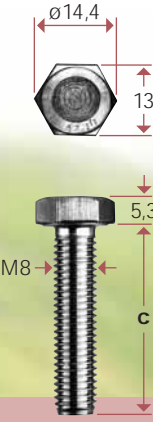

No. 30843-0800-016

0800-016	16
0800-025	25
0800	40

1.4404 / AISI 316

SOCKET HEAD SCREW

DIN 912

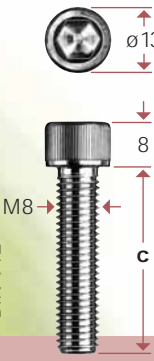

No. 30844-0800-016

0800-016	16
0800-025	25
0800	35

1.4404 / AISI 316

WASHER

DIN 433

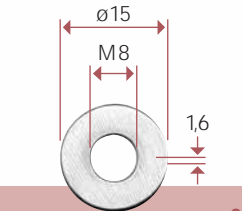

No. 30896-0800

1.4404 / AISI 316

WASHER FOR WOOD

DIN 9021 B

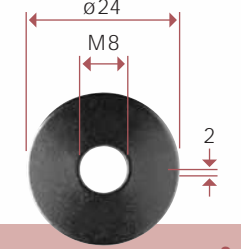

No. 30896-0800-24

1.4404 / AISI 316

TVM mortar

is a two-component synthetic resin mortar. A mounting kit consists of:

- 1 cartridge 150 ml with press barrel
- 2 mixer tube
- 6 SH perforated anchors

The perforated anchor is needed only for hollow walls. The threaded rod can be cemented directly into solid walls.

VC3 thread lock fluid

Lacquer-like coating which contains two separate micro-encapsulated components. The locking action becomes effective when a male and female thread pair is tightened. The connection becomes vibration-proof. The thread lock fluid prevents self-loosening.

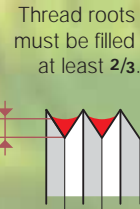

VC3 THREAD LOCK FLUID



No. 30879-0001

HEXAGON NUT

DIN 934



No. 30892-0800

1.4404 / AISI 316

DOME NUT

DIN 1587



No. 30894-0800

1.4404 / AISI 316

LOCK NUT

DIN 985

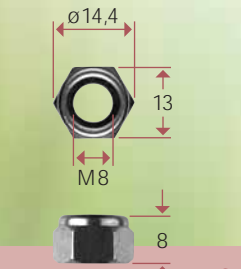

No. 30892-0800-02

1.4404 / AISI 316

ANGLE SECTION

Dimensions and holes to your specifications
Length max. 2500 mm



Costs per cut: No. 20800-0005 / Costs per drilling: No. 20800-0006

FLAT SECTION

Dimensions and holes to your specifications
Length max. 2500 mm



Costs per cut: No. 20800-0005 / Costs per drilling: No. 20800-0006

SECTION CONNECTOR

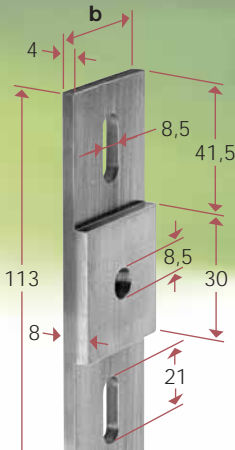

No. 30922-3004

3004	30
4004	40

1.4404 / AISI 316

HORIZONTAL ROD

Ø 3.7
Length max. 2500 mm



No. 30922-0400-00

Costs per cut: No. 20800-0002

CLIMBER STUD

UV-resistant plastic
Colour grey



No. 30906-0400

PVC

GREENGUIDE OVERLOAD CLAMP

Slip element for vigorous twiners

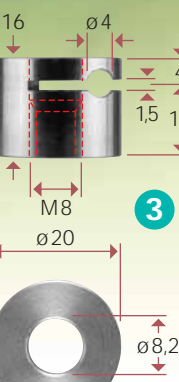

No. 30920-0400-10

1.4404 / AISI 316

SPACER WASHERS

For GreenGuide eyes

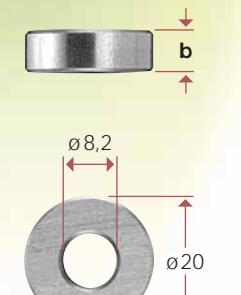

No. 30922-0800-02

0800-01	6
0800	12

1.4404 / AISI 316

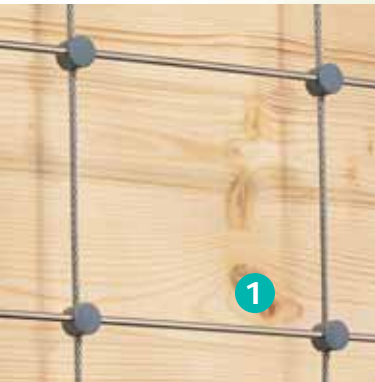

GreenGuide overload clamp: see description on page 19 + 29

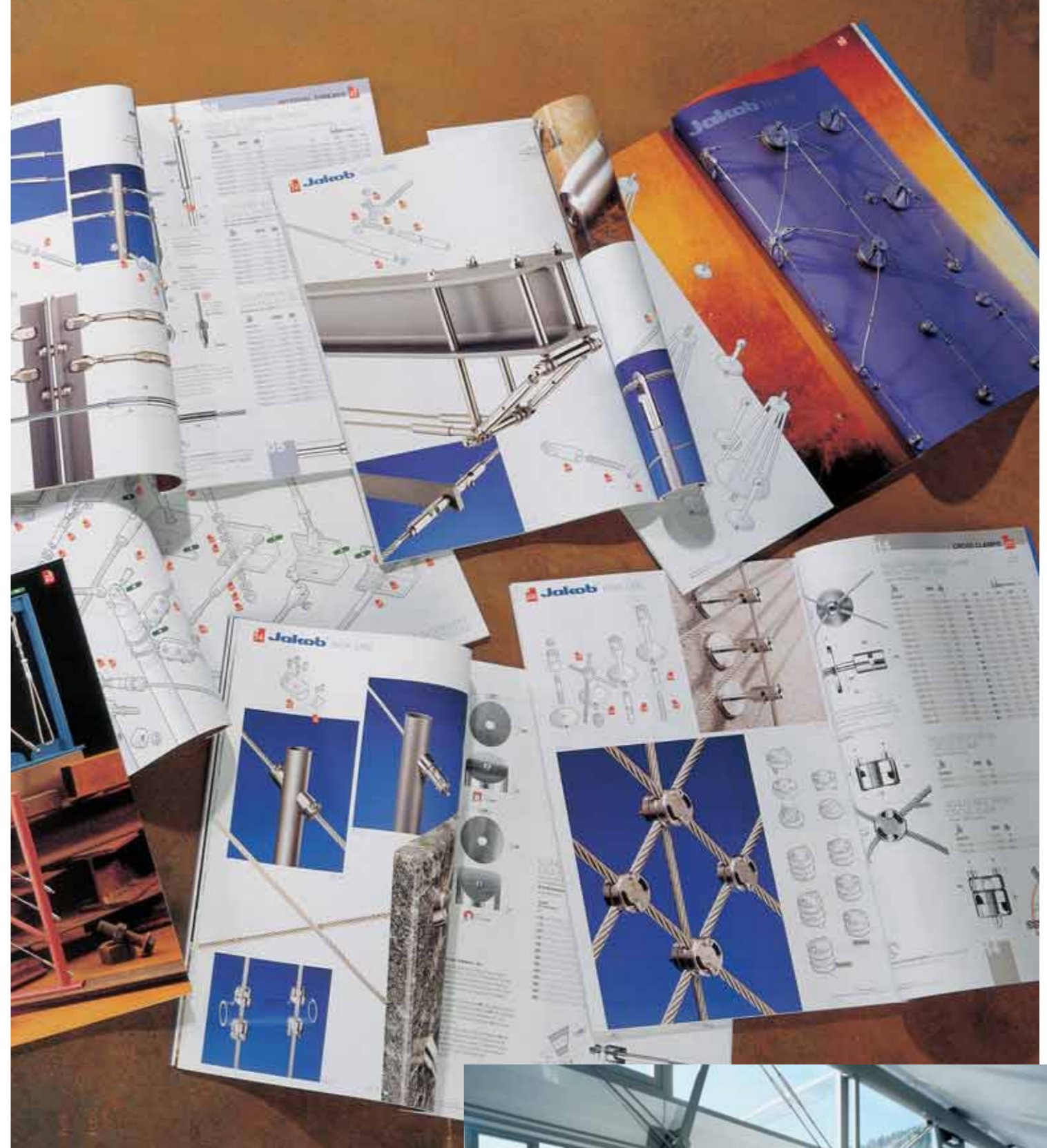
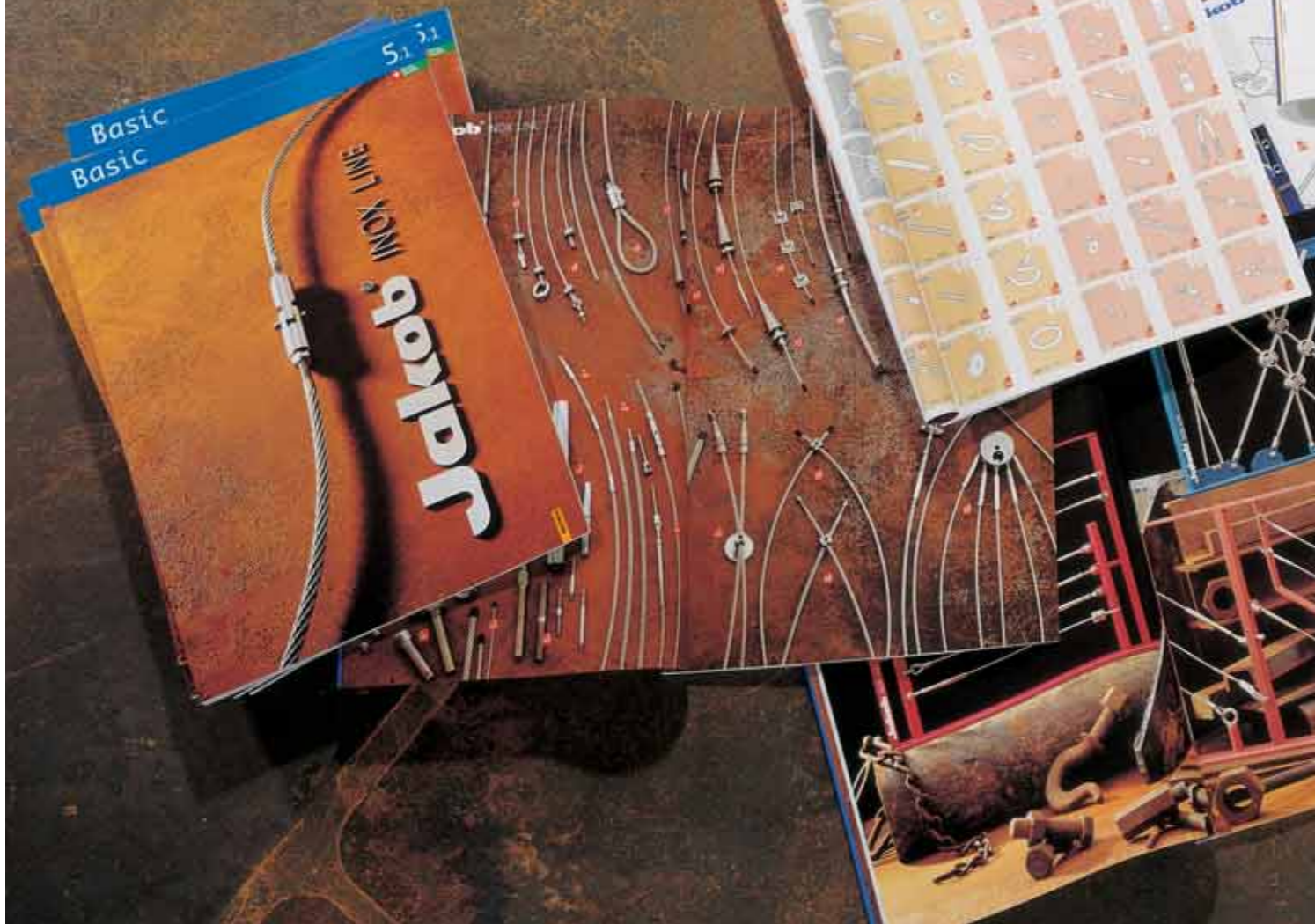

ORDER OUR **MAIN CATALOGUE 5.1**
MORE IDEAS FOR TOTAL SOLUTIONS

Have you seen our main catalogue 5.1?
It is a valuable tool for designers in every discipline.
If you're looking for innovative solutions which go far beyond
greening concepts, you can't afford to be without it.

Order your copy now: www.jakob.ch

