

DXD 300-BSY+ HS / DXD 300-K-BSY+ HS

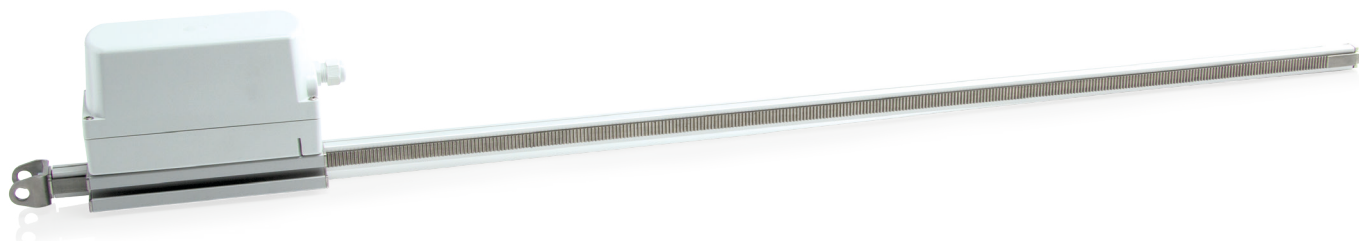
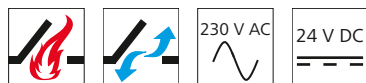

Performance features

- » Can be used for openings for smoke exhaust; D+H Euro SHEV in accordance with EN 12101-2; and for daily ventilation
- » With BSY+ motor and synchronised electronics controlled via microprocessor
- » Direct control via 230 V AC (DXD 300-K-BSY+)
- » High-speed function (HS) for especially fast opening windows in case of fire (SHEV)
- » Option of up to 4 drives in one synchronous group
- » Groove in the drive tube for flexible installation and configuration of the swivel range
- » Option of cable infeed above and below
- » Programmable drive functions and different drive parameters
- » Running speed in CLOSED direction decreases to 5 mm/s (passive closing edge protection)
- » Time-controlled reversing when an obstacle is detected in the CLOSED direction (active closing edge protection)

Approvals / Certificates

Find out about permission details from your D+H Partner.



5014068.18004



Article also available with the following permissions under other article numbers. Technical data may deviate.



Pressure load diagram

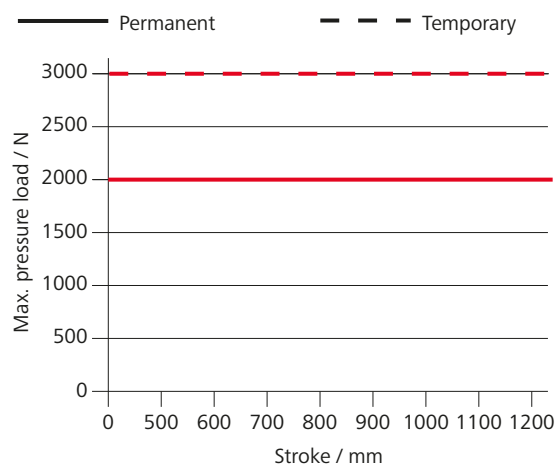

Technical data

	DXD 300-BSY+ HS	DXD 300-K-BSY+ HS
Supply	24 V DC / ±15 % / 5 A	230 V AC / +10 % ... -15 % / 175 VA
Duty cycle	30 % (ON: 3 min. / OFF: 7 min.)	
Force of pressure	3000 N	
Tensile force	2000 N	
Nominal locking force **	2800 N	
Service life	20000 double strokes *	
Stroke	500 - 1500 mm	
OPEN running speed	7.1 mm/s	
OPEN running speed - HS	17 mm/s	
CLOSED running speed	7.1 mm/s	
Type of protection	IP 64	
Emission sound pressure level	LpA ≤ 70 dB(A)	
Temperature range	-15 °C (-5 °C ***) ... +75 °C	
Fire resistance	B300 (30 min / 300 °C)	
Housing	Aluminium / Polycarbonate	
Surface	Powder-coated	
Connection	Silicone cable	
Dimension A	706 - 1706 mm	

For an illustration of the dimensions, see the next page.

* For vertical use, please consult with D+H Sales!

** Depending on the mounting, *** in accordance with VdS 2580

DXD 300-BSY+ HS / DXD 300-K-BSY+ HS

Potential drive options

You can find the explanations for the icons on the last page.

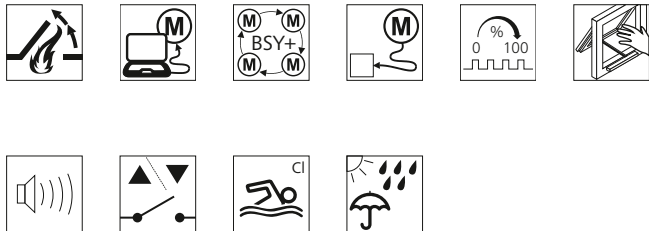

Dimensions

All specifications in mm

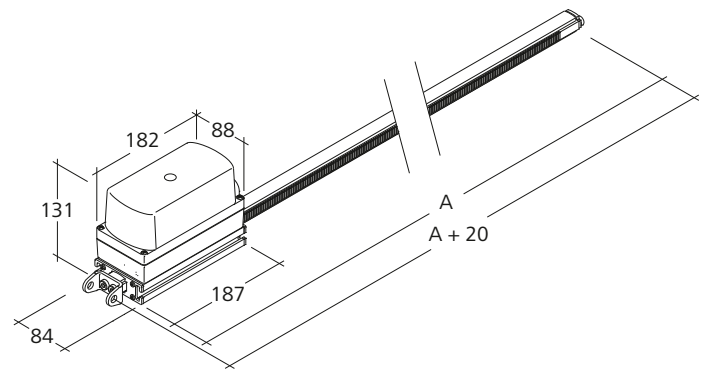

Design

Type	Art. No.	Dimension A	Remark
DXD 300/1000-BSY+ OT-HS	20.027.20	706 - 1706 mm	
DXD 300-BSY+	20.022.06	706 - 1706 mm	Variable equipment possible
DXD 300-K-BSY+	20.022.08	706 - 1706 mm	Variable equipment possible

Brackets are not included and have to be ordered separately.

Possible applications

Illustration provided as an example

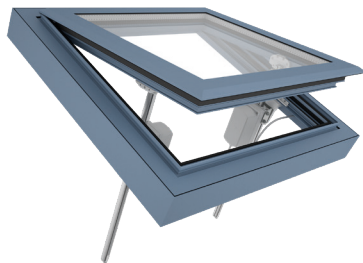
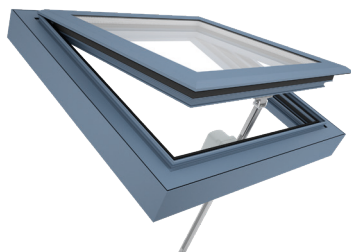

- » Mounted installation
- » Sash mounting
- » Frame mounting
- » Side installation
- » Installation opposite the hinge
- » Application force
- » Application tension



HS "High speed"

In the case of SHEV, the high-speed function is used for reliably reaching the defined end position in 60 s. In daily ventilation mode, the drive runs quietly and quickly, as usual.



Function programming

Option for customised configuring of drive parameters (e.g. stroke) via software and associated service tools for drives equipped with PLP, BSY or BSY+ electronics.



BRV signal

Acknowledgement from the drive, via a control cable, to confirm that it has been completely extended or retracted. When used with the AT 41 and ERM 44 modules, this signal is sent to the central building control system, the modules themselves, or to the locking drive. The BRV signal is not isolated.



ACB (Advanced Communication Bus)

Enables direct bus communication between the controller and the drive for, for example, control with perfect positioning or drive feedback. Communication is via the open source Modbus protocol, and it enables the drive to be combined with an ACB-capable control panel or enables it to be directly connected to higher-level controllers such as a building management system.



BSY+ (synchronisation of drives)

BSY+ enables communication and synchronisation between different components in the window. For example between the chain drives, during synchronous operation, or between window and locking drives (e.g. FRA 11 BSY+ or VLD-BSY+).



SGI signal (position reporting)

In combination with the D+H servo plug-in unit SE 622 or the BSY-gateway BSY-GW-024-010-U, the drives can be controlled with perfect positioning.



SKS (closing edge protection)

Drive option, which enables an anti-trap strip or presence detector to be connected directly to the drive (terminal resistor 5.6 kΩ).



Audible signal (corresponding to protection class)

AS2 corresponding to "Protection class 2" in accordance with ZVEI risk assessment through an audible warning signal in the "CLOSED" running direction. AS3 corresponding to "Protection class 3" in accordance with ZVEI risk assessment, in addition to AS2, stops the drive for 11 s with a remaining stroke of 28 mm.



End position message (OPEN / CLOSED)

Drive feedback via an integrated isolated switching contact. This happens if the chain / rack and pinion has moved completely out or in.



WS (use in swimming pool)

Available as an option for rack and pinion drives to make them suitable for use in swimming pools. The drive is equipped with an A4 rack and pinion, A4 eyebolt and a gearbox with hardened stainless steel pinion.



W (use outdoors)

Available as an option for rack and pinion drives to make them suitable for outdoor use. The drive is equipped with a pressure release vent (depending on installation), condensation protective coating on the electronics and a gearbox with hardened stainless steel pinion.