

# EXT - 3.11 VARIOSCREEN

## EXTERNAL AUTOMATED RETRACTABLE SUN ROOF

MOTORISED FABRIC TENSIONED SYSTEM

### APPLICATION VARIOSCREEN

The Varioscreen is a retractable sunroof and acts as an exterior shading system that has been specifically designed to control the entry of natural light, heat and solar energy. The Varioscreen is designed for rooftop installations where large expanses require protection from the sun. Specific applications include skylights, pergolas and custom glass roofing. The system allows the fabric to be projected flat or on an incline/decline. Motorised for ease of use, this Helioscreen system can also be linked for maximum efficiency. All components are either stainless steel or powder-coated aluminium. The Varioscreen system comes with Helioscreens 3 year warranty.

### SYSTEM SPECIFICATIONS VARIOSCREEN

<b>MINIMUM WIDTH</b>	1000mm
<b>MAXIMUM SINGLE WIDTH</b>	5000mm
<b>MAXIMUM LINKED WIDTH</b>	8000mm
<b>MAXIMUM PROJECTION</b>	6000mm

### TECHNICAL INFORMATION VARIOSCREEN

<b>HEAD BOX</b>	<ul style="list-style-type: none"><li>• 235mm x 154mm</li><li>• 2 piece</li></ul>
<b>CONTROL END</b>	<ul style="list-style-type: none"><li>• Automated with remote control</li><li>• Operate up to 4 separate systems on one 4 channel remote</li><li>• Connection to Building Management System optional</li></ul>
<b>TUBE</b>	<ul style="list-style-type: none"><li>• Galvanised Steel</li><li>• 85mm diameter</li><li>• 2mm wall thickness</li></ul>
<b>GUIDING SYSTEM</b>	<ul style="list-style-type: none"><li>• 65mm x 64mm side channels</li></ul>
<b>FRONT BAR</b>	<ul style="list-style-type: none"><li>• Custom powder coating</li></ul>
<b>SUN AND WIND</b>	<ul style="list-style-type: none"><li>• Optional automation via Solris Sun &amp; Wind sensor</li></ul>
<b>CONTROL SYSTEM</b>	<ul style="list-style-type: none"><li>• Automated retraction in high winds</li><li>• Adjustable wind sensitivity levels</li></ul>



INTELLIGENT  
SUN CONTROL  
SOLUTIONS®

# EXT - 3.11 VARIOSCREEN

## 2D DIAGRAM VARIOSCREEN

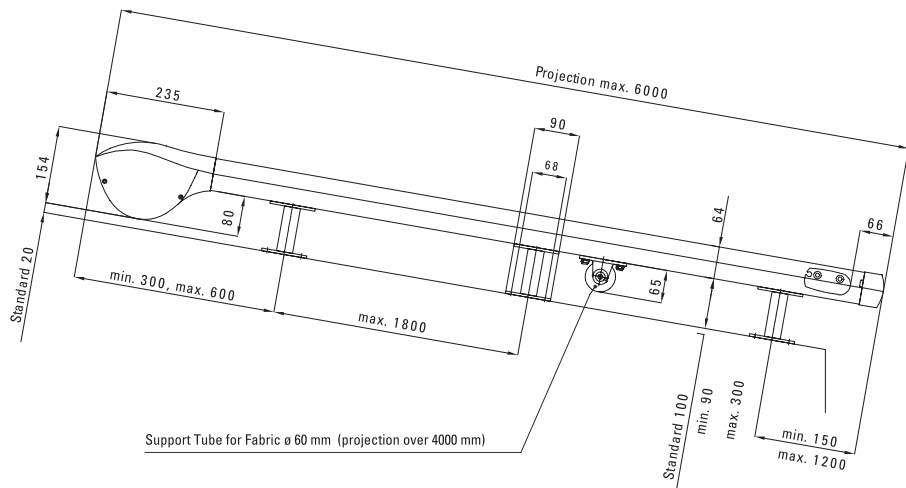
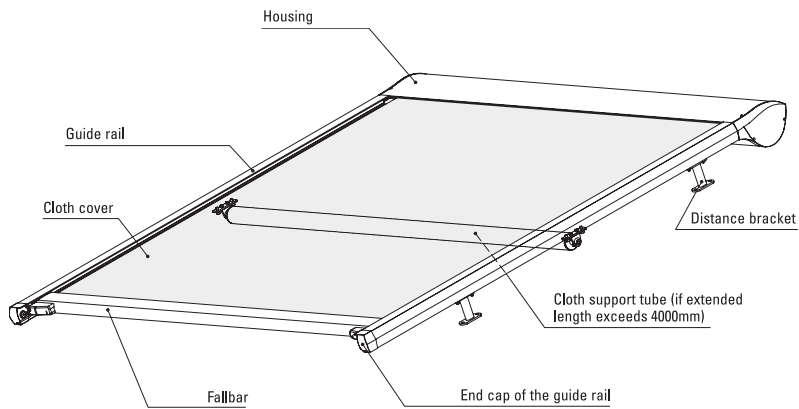

## COMPONENTRY VARIOSCREEN

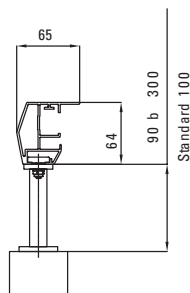

DISTANCED MOUNTING

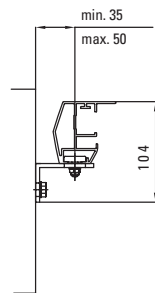

DISTANCED MOUNTING

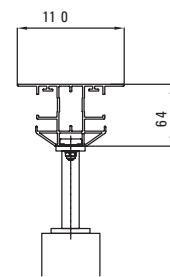

DISTANCED MOUNTING

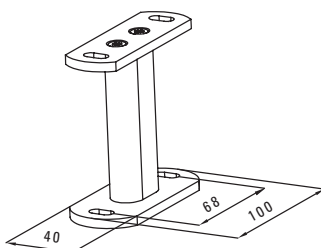

DISTANCE BRACKET

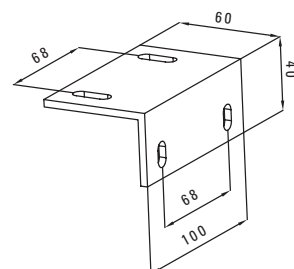

SUPPORT FOR REVEAL MOUNTING

Helioscreen Australia Pty Ltd  
 T +61 2 8426 1300  
 F +61 2 9453 0744  
 W [www.helioscreen.com.au](http://www.helioscreen.com.au)