



# Multi Wall Sheets

Hohlkammerscheiben



MULTI WALL SHEETS

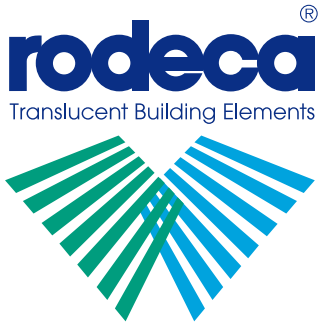

# MULTI WALL SHEETS

Translucent Building Elements  
Lichtbauelemente

Multi Function Panels  
Multi-Funktions-Paneele

## Multi Wall Sheets

### Advantages

- Polycarbonate is a crystal clear, high impact thermoplastic
- Temperature resistance from -40 to +115°C, temporarily up to 130°C
- Unchanged impact resistance within these temperatures
- good long term performance through UV protection
- 10 years warranty against yellowing - ageing - hail stone
- translucent with excellent thermal properties

### Versions

- Heatbloc-Design depending on product type whether Version DECOCOLOR or Version DUOCOLOR
- Frozen-Design Version DECOCOLOR, with fibre glass structure on the outer layer of 16-2
- High Impact Version 16-5 HI improved protection against hail stone
- Closed edges for all widths according to customer demand (please inquire minimum quantity)

### Available thicknesses / Manufacturing program

Multi Wall Sheets can be used in many different ways. They are manufacturable in different thicknesses and widths. Variable widths can be produced with closed edges according to customers demand. Standard colour is for all MWS clear. Additional standard colours depending on product type are available.

4	MWS	Up-value W/m <sup>2</sup> K Installation vertical / horizontal	Weight kg/m <sup>2</sup>	Variable widths (mm)	Standard widths (mm)
	4-2	3.9 / 4.4 W/m <sup>2</sup> K	approx. 0.83	500-1050	2100
4.5-2	3.8 / 4.3 W/m <sup>2</sup> K	approx. 1.0	500-1050	-	

PC 4-2

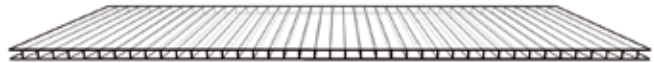

PC 4.5-2

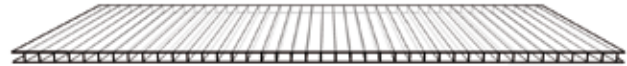

6	MWS	Up-value W/m <sup>2</sup> K Installation vertical / horizontal	Weight kg/m <sup>2</sup>	Variable widths (mm)	Standard widths (mm)
	6-2	3.5 / 3.9 W/m <sup>2</sup> K	approx. 1.3	-	2100
6(10)-2	3.5 / 3.9 W/m <sup>2</sup> K	approx. 1.3	550-1250	1202	

PC 6-2



PC 6(10)-2



8	MWS	Up-value W/m <sup>2</sup> K Installation vertical / horizontal	Weight kg/m <sup>2</sup>	Variable widths (mm)	Standard widths (mm)
	8-2	3.2 / 3.5 W/m <sup>2</sup> K	approx. 1.5	550-1250; invariable 2100	-

PC 8-2

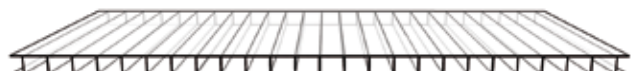

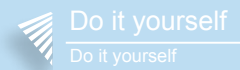

## Available thicknesses / Manufacturing program

10	MWS	Up-value W/m <sup>2</sup> K Installation vertical / horizontal	Weight kg/m <sup>2</sup>	Variable widths (mm)	Standard widths (mm)
	10-2	3.0 / 3.2 W/m <sup>2</sup> K	approx. 1.7	550-1250	2100
	10-4	2.5 / 2.7 W/m <sup>2</sup> K	approx. 1.75	-	2100

PC 10-2

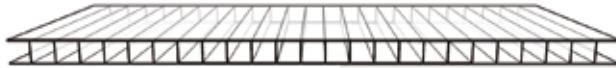

PC 10-4



16	MWS	Up-value W/m <sup>2</sup> K Installation vertical / horizontal	Weight kg/m <sup>2</sup>	Variable widths (mm)	Standard- width (mm)
	16-2	2.6 / 2.9 W/m <sup>2</sup> K	approx. 2.0	630-1250	980 + 1200
	16-3	approx. 2.2 / 2.4 W/m <sup>2</sup> K	approx. 2.7	-	980 + 1200
	16-X	approx. 2.1 / 2.2 W/m <sup>2</sup> K	approx. 2.5	-	980 + 1200
	16-7	1.8 / 1.9 W/m <sup>2</sup> K	approx. 2.6	700-1230	980 + 1200 2100
	16 -N	2.4 / 2.6 W/m <sup>2</sup> K	approx. 2.7	950-1260	-
	16-5 HI	2.0 / 2.1 W/m <sup>2</sup> K	approx. 4.0	700-1250*	980

PC 16-2



PC 16-3



PC 16-X



PC 16-7



PC 16-N



PC 16-5 HI



## MWS

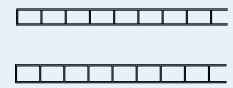

4



6



8



10

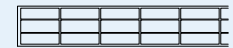

16

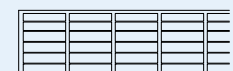
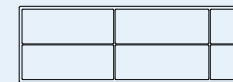

\*with reservation



## Multi Wall Sheets

### Advantages

- Polycarbonate is a crystal clear, high impact thermoplastic
- Temperature resistance from -40 to +115°C, temporarily up to 130°C
- Unchanged impact resistance within these temperatures
- good long term performance through UV protection
- 10 years warranty against yellowing - ageing - hail stone
- translucent with excellent thermal properties

### Applications

- Winter gardens
- Conservatories
- Roofing constructions
- Pergolas
- Light-bands
- Canopies
- Interior applications

### Available thicknesses / Manufacturing program

20	MWS	Up-value W/m <sup>2</sup> K** Installation vertical / horizontal	Weight kg/m <sup>2</sup>	Variable widths (mm)	Standard widths (mm)
	20-2	2.5 / 2.8 W/m <sup>2</sup> K	approx. 2.8	630-1250	-
20-7	1.5 / 1.6 W/m <sup>2</sup> K	approx. 2.9	700-1230; invariable 2100	-	

PC 20-2



PC 20-7

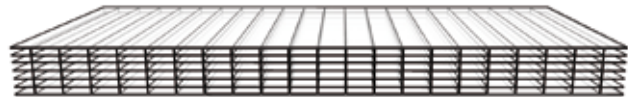

25	MWS	Up-value W/m <sup>2</sup> K** Installation vertical / horizontal	Weight kg/m <sup>2</sup>	Variable widths (mm)	Standard-width (mm)
	25-7	1.4 / 1.5 W/m <sup>2</sup> K	approx. 3.2	700-1230; invariable 2100	980 + 1200

PC 25-7

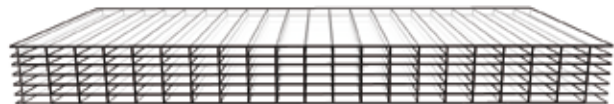

### Performance characteristics

All Multi Wall Sheets are CE marked in accordance to the CPR and EN 16153. The corresponding performance characteristics are part of the declarations of performance.



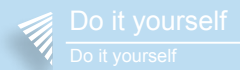

## Available thicknesses / Manufacturing program

32	<b>MWS</b>	<b>Up-value W/m<sup>2</sup>K**</b> Installation vertical / horizontal	<b>Weight kg/m<sup>2</sup></b>	<b>Variable widths (mm)</b>	<b>Standard widths (mm)</b>
	32-10	1.2 / 1.2 W/m <sup>2</sup> K	approx. 3.6	700-1230	1230

PC 32-10



40	<b>MWS</b>	<b>Up-value W/m<sup>2</sup>K</b> Installation vertical / horizontal	<b>Weight kg/m<sup>2</sup></b>	<b>Variable widths (mm)</b>	<b>Standard widths (mm)</b>
	40-10	1.0 / 1.1 W/m <sup>2</sup> K	approx. 4.0	700-1230	980

PC 40-10

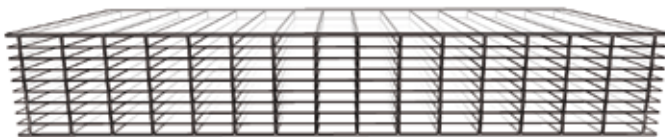

## MWS



20



25

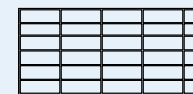

32

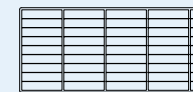

40

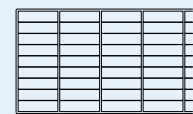

## Versions COLOR, DECOCOLOR & DUOCOLOR

You can find our range of colours and product versions in the single product datasheets.



# MULTI WALL SHEETS

Translucent Building Elements  
Lichtbauelemente

Multi Function Panels  
Multi-Funktions-Paneele

## Multi Wall Sheets

Polycarbonate adapter



Gaskets

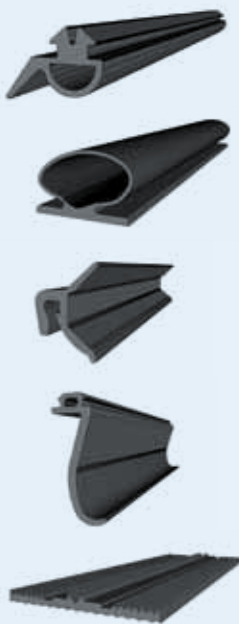

## Applications

The different combinable profiles and adapters give versatile construction possibilities. All products are manufacturable in different colours and versions. E. g. the Decocolor/Duocolor versions with "heatbloc", prevent heat build up in summer and this way have share in energy efficiency of a building.

### System example "Quick-click"!

- easy installation by simple Click-in system
- variable adapter combinations for different MWS thicknesses

Width 60 mm

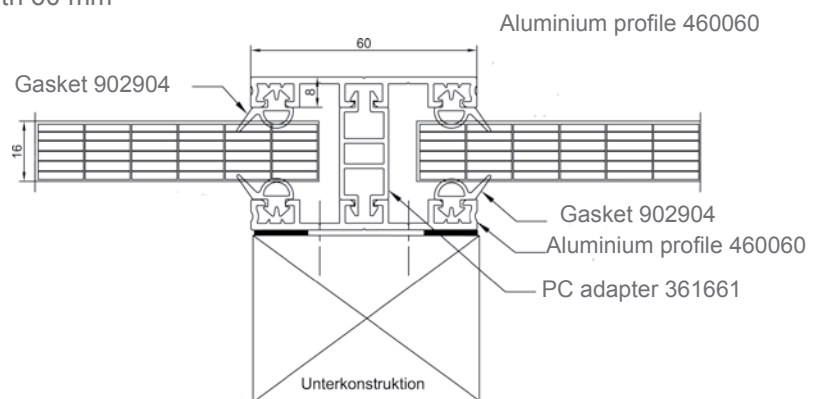

### Quick-click-system for 10mm MWS

Aluminium profile 460060 with gaskets 902904 and PC adapter 361061

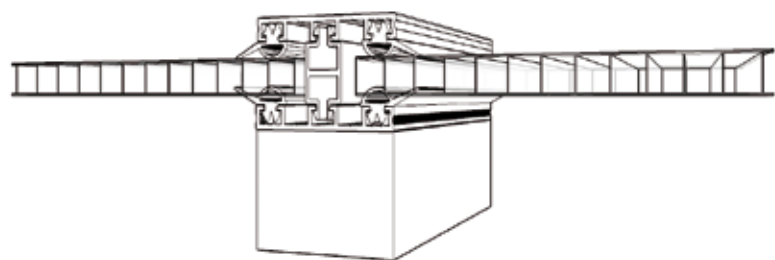

Aluminium installation systems for Multi Wall Sheets from 10 mm to 40 mm thickness.





RT-Thermolight  
RT-Thermolight

U-Panels  
U-Paneele

Windows  
Fenster

Do it yourself  
Do it yourself

All Multi Wall Sheets are coextruded with a UV-protection layer. This gives maximum protection against excessive weathering and yellowing (for more information see General Terms and Conditions/ Rodeca warranty declaration).

### Quick-click-system for 16mm MWS

Aluminium profile 460060 with gaskets 902904 and PC adapter 361661

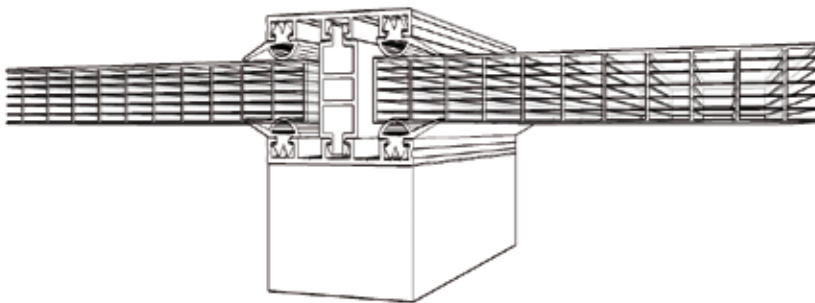

### Quick-click-system for 20mm MWS

Aluminium profile 460060 with gaskets 902904, aluminium adapter 470260 and PC adapter 361061

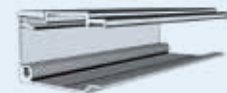
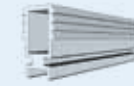
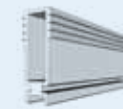
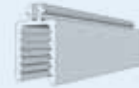
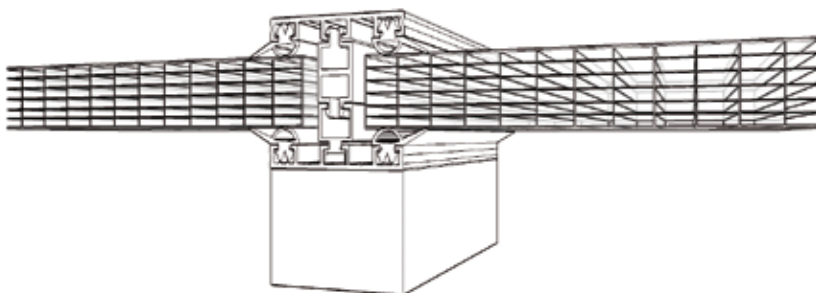

Aluminium adapter

Aluminium profiles

## Multi Wall Sheets

### PC adapter



### Gaskets

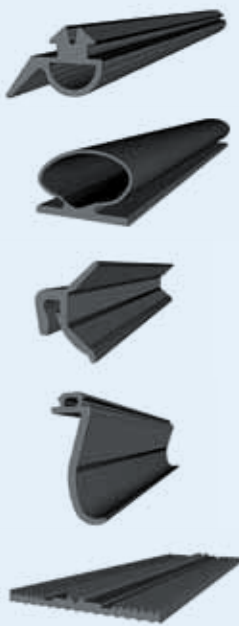

## Thermo-Vario System

- thermal separation of aluminium profiles
- Adapter with tooth blade system for MWS from 10 to 40 mm thickness
- easy installation by pressing on adapter, no additional screwing

Width 60 mm

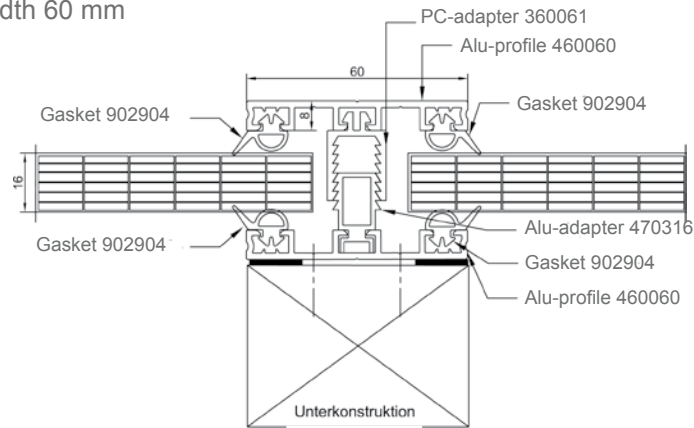

## System Thermo-Vario for 16mm MWS

Aluminium profile 460060 with gaskets 902904, aluminium adapter 470316 and PC adapter 360061

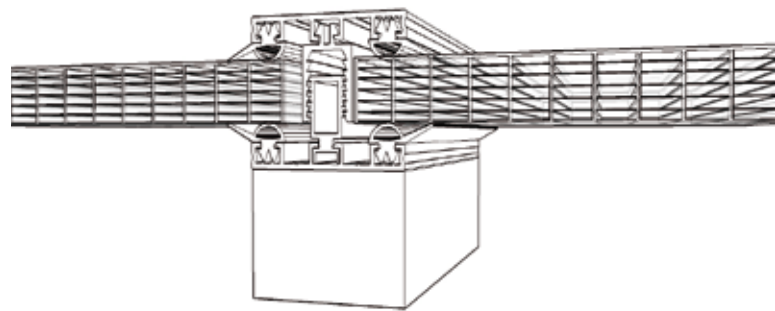

## System Thermo-Vario for 40mm MWS

Aluminium profile 460060 with gaskets 902904, aluminium adapter 470260 and 470332, additionally PC adapter 360061

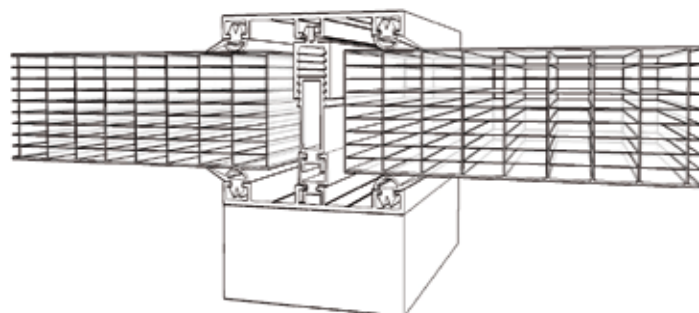





RT-Thermolight  
RT-Thermolight

U-Panels  
U-Paneele

Windows  
Fenster

Do it yourself  
Do it yourself

## System with flat gasket strip

- easy system with minimized material consumption
- self adhesive support strip in 60 mm width for clean and easy installation

Width 60 mm

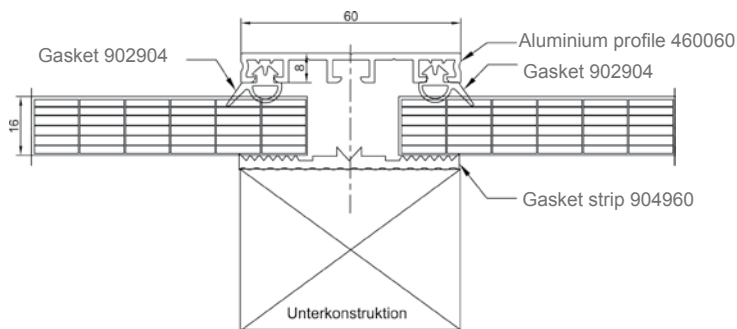

## System flat gasket strip for 16mm MWS

Aluminium profiles 460060 with gaskets 902904 and flat gasket strip 904960

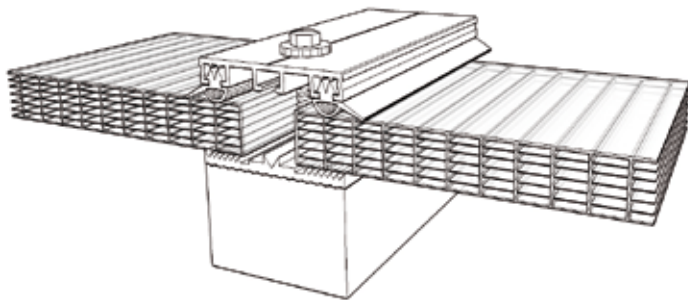

Aluminium installation systems for Multi Wall Sheets from 10 mm to 40 mm thickness.

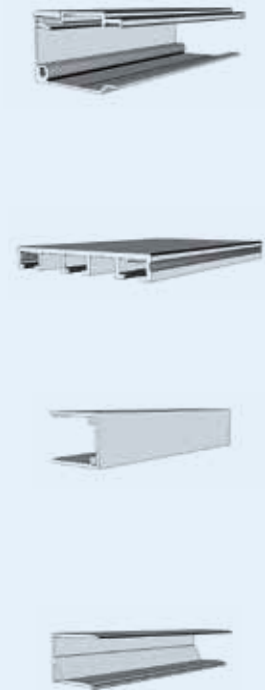

Aluminiumprofile

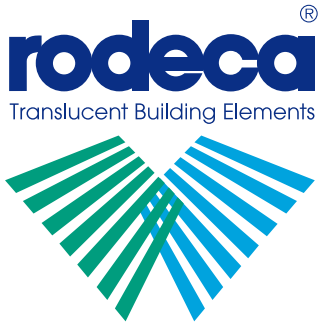

# MULTI WALL SHEETS

Translucent Building Elements  
Lichtbauelemente

Multi Function Panels  
Multi-Funktions-Paneele

## Multi Wall Sheets

### Components

PC H-Profiles

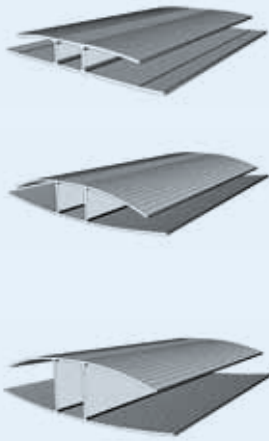

PC U-Profiles

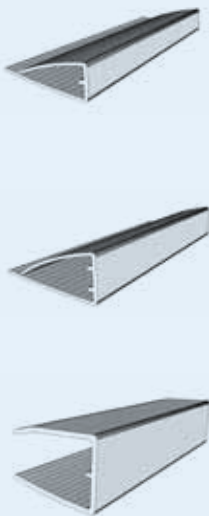

### Polycarbonate installation systems

- light weight translucent polycarbonate profiles
- applicable for Multi Wall Sheets from 6 to 16mm thickness

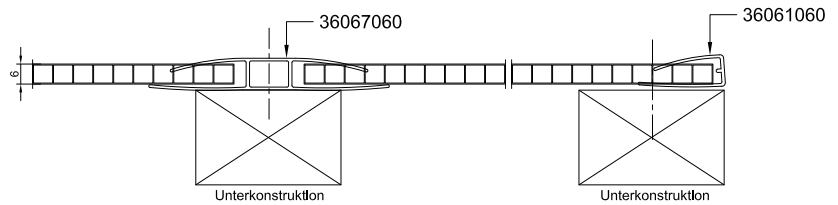

### Polycarbonate H-connection profile for MWS

- Polycarbonate H-connection profile 36067060 for 6mm MWS
- Polycarbonate H-connection profile 36107060 for 8 and 10mm MWS
- Polycarbonate H-connection profile 36167060 for 16mm MWS



### Polycarbonate U-profiles for MWS

- Polycarbonate U-profile 36061060 for 6mm MWS
- Polycarbonate U-profile 36101060 for 8 and 10mm MWS
- Polycarbonate U-profile 36161060 for 16mm MWS

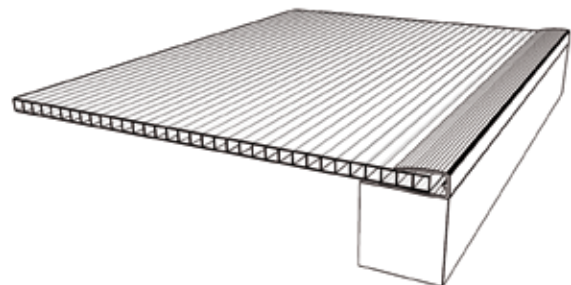

All installation advice, application requirements and additional technical information can be viewed in our technical manuals and installation manuals.





## Germany

RODECA GmbH  
Freiherr-vom-Stein-Straße 165  
D-45473 Mülheim an der Ruhr  
Fon +49 (0) 208 76502-0  
Fax +49 (0) 208 76502-11  
info@rodeca.de  
[www.rodeca.de](http://www.rodeca.de)

## United Kingdom

RODECA Ltd.  
Bentalls House  
Bentalls  
Pipps Hill Industrial Estate  
Basildon  
Essex SS14 3BS  
Fon + 44 (0) 1268 531466  
Fax + 44 (0) 1268 526351  
sales@rodeca.co.uk  
[www.rodeca.co.uk](http://www.rodeca.co.uk)

## Italy

ANSA Termoplastici S.r.l./RODECA Italy  
Concessionaria per l'Italia di RODECA GmbH  
Via Nazionale, 66  
24060 Sovere (BG)  
Fon +39 035 981431  
Fax +39 035 981529  
info@rodeca.it  
[www.rodeca.it](http://www.rodeca.it)

## The Netherlands

RODECA Systems b.v.  
Koperweg 11 N  
2401 LH Alphen aan den Rijn  
Fon +31 (0) 172 416 747  
Fax +31 (0) 172 419 090  
info@rodeca.nl  
[www.rodeca.nl](http://www.rodeca.nl)

## Belgium and Luxembourg

RODECA Systems BELUX bvba  
Wupstraat 37  
2812 Muizen/Mechelen  
Mobile +32 (0) 468 137 677  
Fax (NL) +31 (0) 172 419 090 (RODECA Systems b.v.)  
info@rodeca.be  
[www.rodeca.be](http://www.rodeca.be)

## South America

REPLAEX RESINAS PLÁSTICAS EXTRUDADAS  
LTDA  
Autorizado America do Sul de RODECA GmbH  
Estrada da Ligeira, 839 - Taquara - Rio de Janeiro  
RJ - BRASIL  
cep. 22713-470  
Fon : +55 (0) 21 2446-8811  
Fax : +55 (0) 21 2446-7181  
vendas@replaex.com.br  
[www.replaex.com.br](http://www.replaex.com.br)

## The RODECA product groups overview / Die RODECA Produktgruppen im Überblick:



### Translucent Building Elements

Lichtbauelemente



### Multi Wall Sheets

Hohlkammerscheiben



### Multi Function Panels

Multi-Funktions-Paneele



### U-Panels

U-Paneele



### RT-Thermolight

RT-Thermolight



### Windows

Fenster



### Do it yourself

Do it yourself