

Doric is the largest privately owned hardware manufacturer in Australia supplying innovative and industry leading door and window hardware for Residential, Commercial, Timber, Security and Architectural applications.

If you need any type of hardware for windows and doors talk to us at Doric! We also can create customised product to give you a unique offering and competitive advantage in the market.

**Melbourne**

U1/34-36 Deans Crt,  
Dandenong Sth, Vic 3175  
Ph: (03) 9587 3195  
Fax: (03) 9587 3196

**Brisbane**

U1/90 Pritchard Rd,  
Virginia, QLD 4014  
Ph: (07) 3865 7637  
Fax: (07) 3865 7645

**Perth**

2 Meares Way  
Canning Vale WA 6155  
Ph: (08) 9248 4133  
Fax: (08) 9248 4933

**Adelaide**

Unit 2 / 52 Wodonga St  
Beverley SA 5009  
Ph: (08) 8443 3370  
Fax: (08) 8443 3066

**Newcastle**

2/100 Munibung Rd,  
Cardiff, NSW 2258  
Ph: (02) 4956 8508  
Fax: (02) 4956 8495

**Townsville**

U1/42 Carmel St,  
Garbutt, QLD 4814  
Ph: (07) 4779 5122  
Fax: (07) 4725 5495

**Auckland NZ**

32/D William Pickering Dr  
Albany North Shore  
NZ 0751  
Ph : +64 9 415 5535  
Fax: +64 9 415 5545

**Asia Pacific**

7 Jalan Bulan U5 / 170  
Bandar Pinggiran Subang,  
40150 Shah Alam  
Selangor, Malaysia  
Ph : +60 3 7845 5017  
Fax: +60 3 7845 5014



**HEAD OFFICE**

160 Newton Rd,  
Wetherill Park  
NSW 2164  
Ph: (02) 9609 2555  
Fax: (02) 9604 2910

**EMAIL CONTACTS**

[sales@doric.com.au](mailto:sales@doric.com.au)

**WEBSITE**

[www.doric.com.au](http://www.doric.com.au)

# The Sterling Series Window Accessories





Industry Leading Window Hardware for Timber Windows



# The Sterling Series Timber Window Locking Range

The Doric Sterling Series window locking range for timber windows, has been specially developed for modern joinery applications.

Combining modern styling with superior quality this range is a must have for timber joinery.

| Finishes & Colours   |   |
|--|---|
| Plated   | Powder Coat   |
|  Satin Nickel |  Black           |
|  PVD Gold     |  White           |
|  |  Mahogany Bronze |

## DT1 - Double Hung Sash Lock

The double hung sash lock includes a choice of purpose keepers specifically designed to integrate with single and double glazed windows. Incorporating a screw and bushing type pivot assembly, this design will provide years of trouble free operation.

Screw locations have been situated back towards the centre of the windows meeting rails to ensure the best possible fixing on a double hung window.

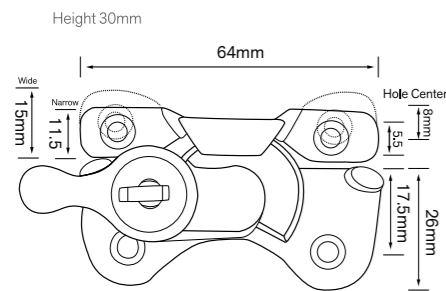

## DT2 - Sash Lifts

True to the range, the Sterling Series sash lifts reflect consistency in design. Manufactured from stainless steel, these premium sash lifts will provide years of functional use.

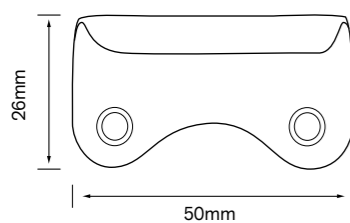

## DT3 - Key Casement Fastener

The Sterling Series casement fasteners are designed with both function and aesthetics in mind. Their sleek contemporary design does not overlap the glass when in the closed position, further enhancing the view.

All fixing screw locations have been positioned to compliment modern weather seal locations.

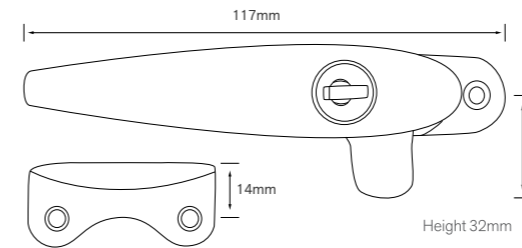

## DT4 - Sliding Window Lock

The Sterling Series sliding window lock has been designed to be surface mounted, unifying top of the range windows. This lockable latch incorporates a functional handle design and features complimentary keepers for both single slide and bi-parting windows.

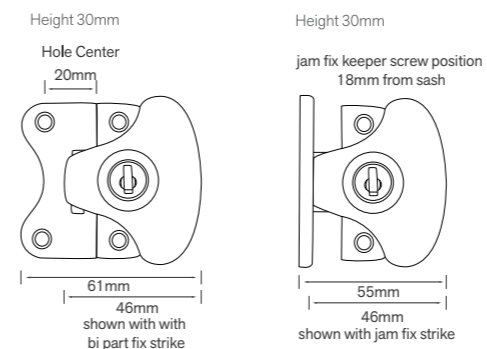

## Related Products

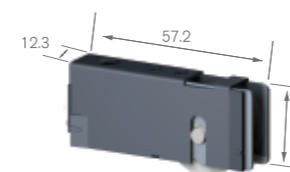

Sliding Window Rollers  
DR142 Window Roller (7.5 kg)  
DR142 SS Window Roller (15 kg)



DR1009 Extra Heavy Duty Window & Door Roller (50kg)  
Suitable for use on timer sliding doors up to 100kg



Timber spring balance system mounted on timber