



Nero

Please note:

Nero Tapware reserves the right to modify specifications shown, or delete products from their range without prior notification.

Nero



About Zen Collection

Nero Tapware proudly presents the Zen collection, featuring entirely 316L stainless steel for a truly high-end experience. Designed for both outdoor and indoor use, the Zen collection ensures durability, environmental friendliness, and a classic appearance. With exceptional environmental adaptability and meticulous craftsmanship, this collection offers four stunning colour options rarely seen in outdoor products. Perfect for various upscale settings, the Zen collection by Nero Tapware creates a truly captivating space.



Lead Free

316L Stainless Steel Material:

The entire Zen collection utilizes 316L lead free stainless steel, known for its exceptional weather and corrosion resistance, making it highly suitable for outdoor applications. This material also provides superior strength, ensuring durability and a unique longevity for the products.



316L Stainless Steel

Health and Environmental Protection

Crafted from high-strength, non-toxic 316L stainless steel, ensures a healthy water environment. This premium material adheres to stringent environmental standards, providing both safety and durability. The Zen collection is 100% recyclable, reflecting Nevo Tapware's dedication to environmental conservation and sustainable development.

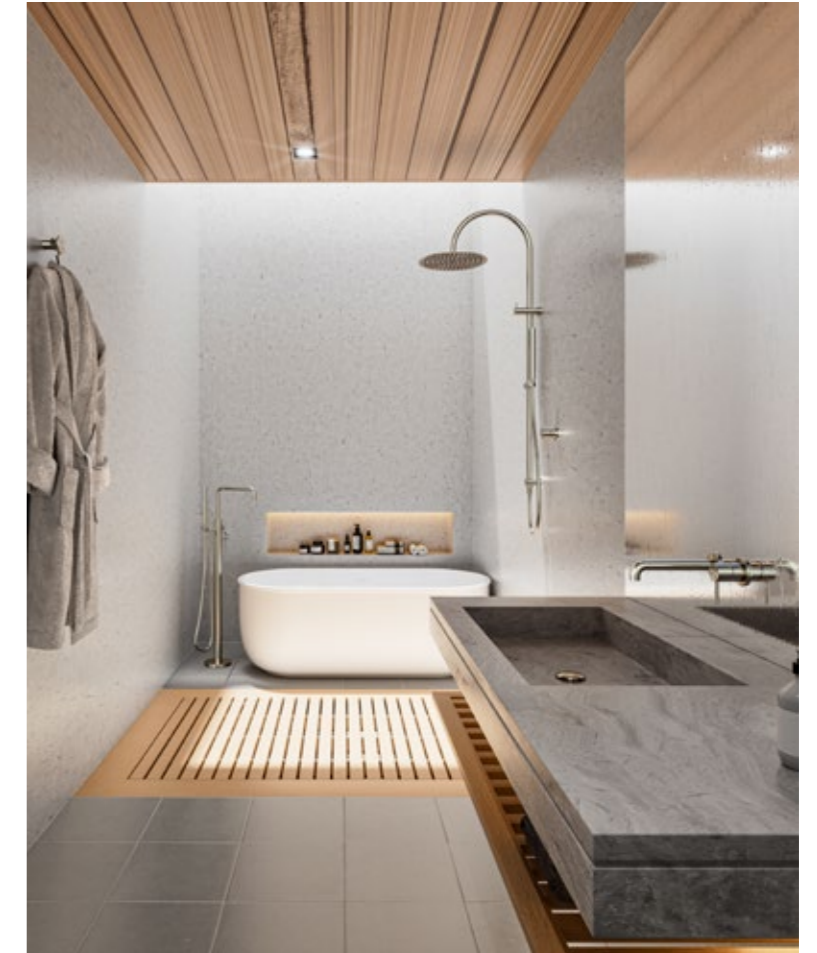

Classic Design and Superior Craftsmanship

The Zen collection boasts a timeless minimalist design coupled with exceptional craftsmanship, showcasing meticulous attention to detail and superior tactile and visual elements. Elevate your indoor and outdoor ambiance with a touch of sophistication and elegance.



Laminar Flow

Innovative Technology and Premium Component

Equipped with high-end components such as top-grade cartridges, flexible hoses, and aerators, the Zen collection also employs innovative Laminar flow technology. Laminar flow tapware delivers a water stream free of air, resulting in a pristine flow that gracefully fills the sink with minimal splashing. Appreciated for its glass-like clarity, many individuals opt for laminar flow in their kitchens and bathrooms to enhance the aesthetic appeal of their spaces.

Diverse colour Options

Available in Graphite, Brushed Nickel, Brushed Gold and Brushed Bronze, each colour option boasts excellent weather and corrosion resistance whilst also providing various personalised designs.

- Brushed Nickel
- Brushed Gold
- Graphite
- Brushed Bronze

Up to 25 Years Warranty

To highlight Nero's confidence in its first outdoor product release, the Zen collection provides an unparalleled 25-year warranty, ensuring confidence in your choice for years to come.

Zen Collection

Mixer Taps





NR162201BN

Zen SS316L Basin Mixer Brushed Nickel
Wels Rating: 6 Star, 4.5L/Min
Wels REG No. T43113

Colours Available:

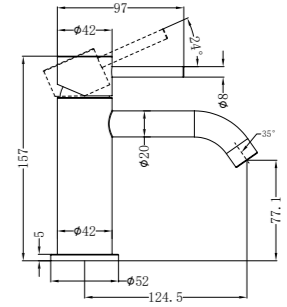

NR162201BG
Brushed Gold



NR162201GR
Graphite



NR162201BZ
Brushed Bronze

NR162201aBN

Zen SS316L Tall Basin Mixer Brushed Nickel
Wels Rating: 6 Star, 4.5L/Min
Wels REG No. T43116

Colours Available:

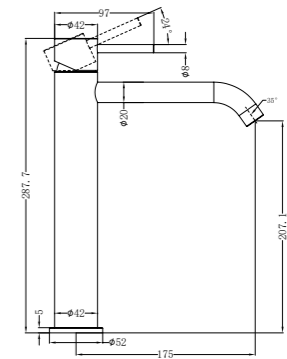

NR162201aBG
Brushed Gold



NR162201aGR
Graphite



NR162201aBZ
Brushed Bronze

NR162201bBN

Zen SS316L Basin Mixer Handless
Brushed Nickel
Wels Rating: 6 Star, 4.5L/Min
Wels REG No. T43115

Colours Available:

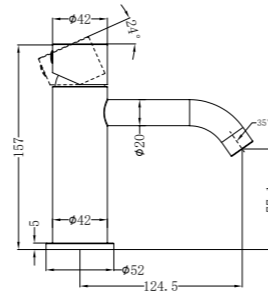
NR162201bBG
Brushed Gold



NR162201bGR
Graphite



NR162201bBZ
Brushed Bronze

NR162201cBN

Zen SS316L Tall Basin Mixer Handless
Brushed Nickel
Wels Rating: 6 Star, 4.5L/Min
Wels REG No. T43114

Colours Available:

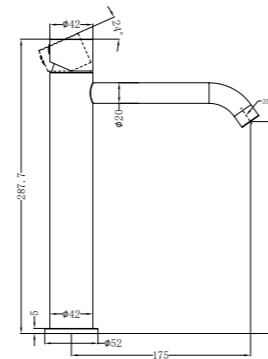
NR162201cBG
Brushed Gold



NR162201cGR
Graphite



NR162201cBZ
Brushed Bronze





NR162207BN

Zen SS316L Kitchen Mixer Brushed Nickel
Wels Rating: 6 Star, 4.5L/Min
Wels REG No. T43108

Colours Available:

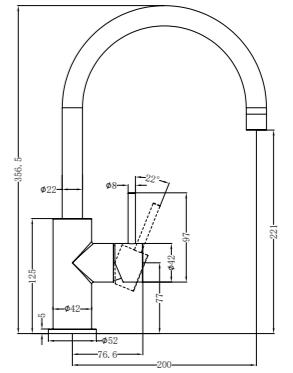

NR162207BG
Brushed Gold



NR162207GR
Graphite



NR162207BZ
Brushed Bronze

NR162208BN

Zen SS316L Kitchen Mixer With
Hand Spray Brushed Nickel
Wels Rating: 6 Star, 4.5L/Min
Wels REG No. T43393

Colours Available:

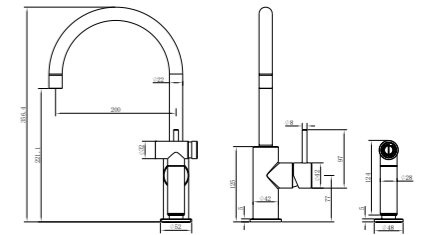

NR162208BG
Brushed Gold



NR162208GR
Graphite



NR162208BZ
Brushed Bronze

NRUB005

SS316L 35mm Premium Universal Wall Basin/Bath Mixer Body Only

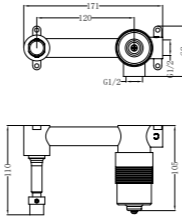

**NR162210a185tBN
NR162210a230tBN**

Zen SS316L Wall Basin/Bath Mixer
185mm/230mm Spout Trim Kits Only
Brushed Nickel
Wels Rating: 6 Star, 4.5L/Min
Wels REG No. T43382/T43383

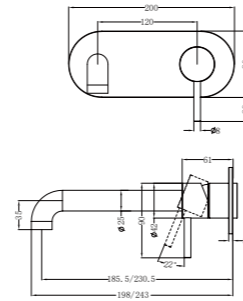

Colours Available:
● ● ● ●



**NR162210a185tBG
NR162210a230tBG**
Brushed Gold



**NR162210a185tGR
NR162210a230tGR**
Graphite



**NR162210a185tBZ
NR162210a230tBZ**
Brushed Bronze

**NR162210a185BN
NR162210a230BN**

Zen SS316L Wall Basin/Bath Mixer
185mm/230mm Spout Brushed Nickel
Wels Rating: 6 Star, 4.5L/Min
Wels REG No. T43382/T43383

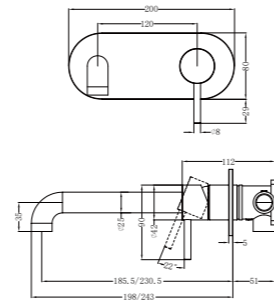

Colours Available:
● ● ● ●



**NR162210a185BG
NR162210a230BG**
Brushed Gold



**NR162210a185GR
NR162210a230GR**
Graphite



**NR162210a185BZ
NR162210a230BZ**
Brushed Bronze





NRUB005

SS316L 35mm Premium Universal
Wall Basin/Bath Mixer Body Only

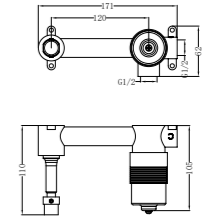

NR162210b185tBN
NR162210b230tBN

Zen SS316L Wall Basin/Bath Mixer
Separate Back Plate 185mm/230mm
Spout Trim Kits Only Brushed Nickel
Wels Rating: 6 Star, 4.5L/Min
Wels REG No. T43384/T43385

Colours Available:
● ● ● ●

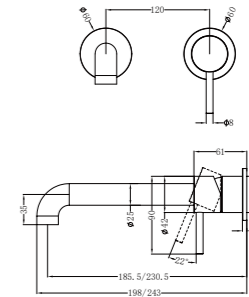

NR162210b185tBG
NR162210b230tBG
Brushed Gold

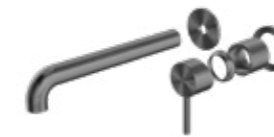

NR162210b185tGR
NR162210b230tGR
Graphite



NR162210b185tBZ
NR162210b230tBZ
Brushed Bronze

NR162210b185BN
NR162210b230BN

Zen SS316L Wall Basin/Bath Mixer
Separate Back Plate 185mm/230mm
Spout Brushed Nickel
Wels Rating: 6 Star, 4.5L/Min
Wels REG No. T43384/T43385

Colours Available:
● ● ● ●

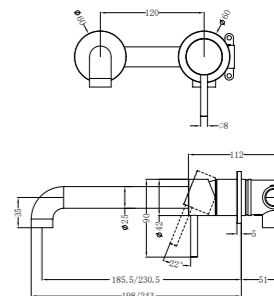

NR162210b185BG
NR162210b230BG
Brushed Gold



NR162210b185GR
NR162210b230GR
Graphite



NR162210b185BZ
NR162210b230BZ
Brushed Bronze

NRUB006

SS316L 35mm Premium Universal Shower Mixer Body Only

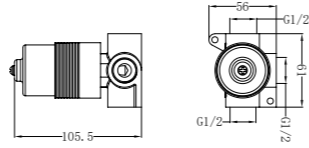

NR16221tBN

Zen SS316L Shower Mixer Trim Kits Only Brushed Nickel
Wels Rating: N/A

Colours Available:
● ● ● ●

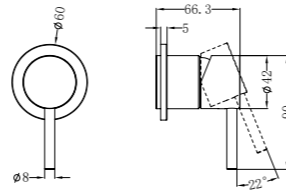

NR16221tBG
Brushed Gold



NR16221tGR
Graphite



NR16221tBZ
Brushed Bronze

NR16221BN

Zen SS316L Shower Mixer Brushed Nickel
Wels Rating: N/A

Colours Available:
● ● ● ●

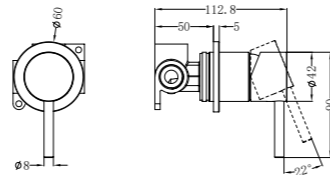

NR16221BG
Brushed Gold



NR16221GR
Graphite



NR16221BZ
Brushed Bronze

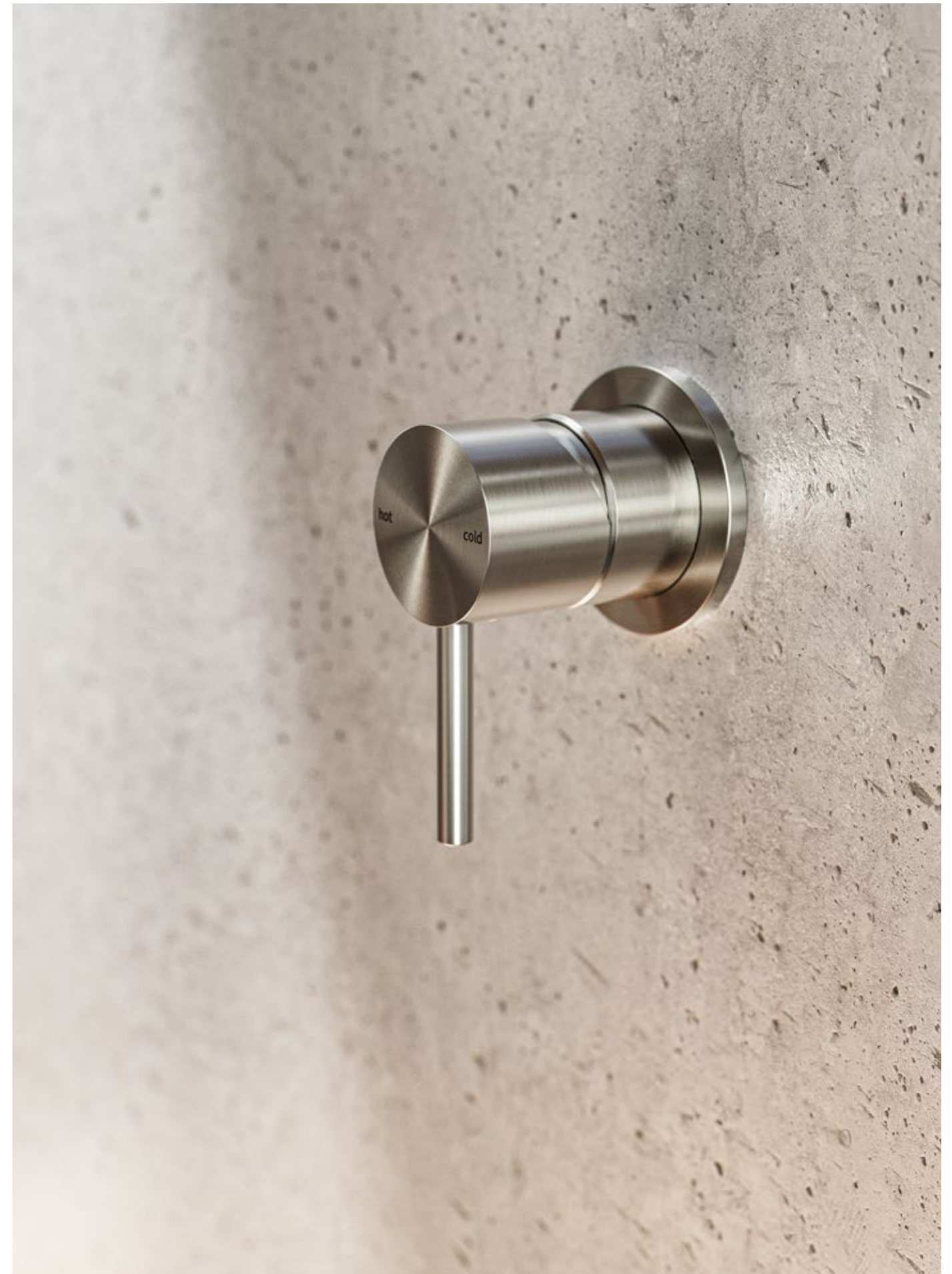



**NR162203b185BN
NR162203b230BN**

Zen SS316L Round Basin/Bath Spout
Only 185mm/230mm Brushed Nickel
Wels Rating: 5 Star, 5L/Min
Wels REG No. T43380/T43381

Colours Available:
● ● ● ●

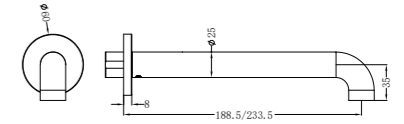

**NR162203b185BG
NR162203b230BG**
Brushed Gold



**NR162203b185GR
NR162203b230GR**
Graphite



**NR162203b185BZ
NR162203b230BZ**
Brushed Bronze

NR162203BN

Zen 316L Stainless Steel Pot
Filler Brushed Nickel
Wels Rating: 3 Star, 9L/Min
Wels REG No. T41712

Colours Available:
● ● ● ●

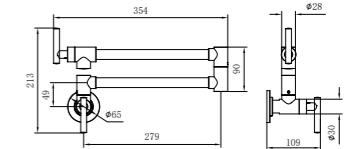

NR162203BG
Brushed Gold



NR162203GR
Graphite



NR162203BZ
Brushed Bronze

Zen Collection

Bathroom Accessories

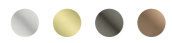

NR1624BN

Zen SS316L Single Towel Rail
600mm Brushed Nickel

Colours Available:

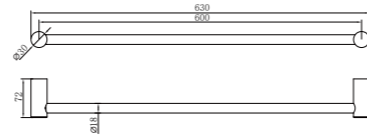
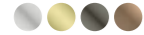

NR1624dBN

Zen SS316L Double Towel Rail
600mm Brushed Nickel

Colours Available:

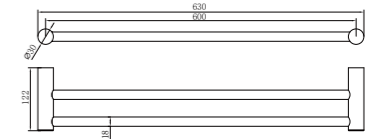

NR1624BG
Brushed Gold



NR1624GR
Graphite



NR1624BZ
Brushed Bronze



NR1624dBG
Brushed Gold



NR1624dGR
Graphite



NR1624dBZ
Brushed Bronze

NR1630BN

Zen SS316L Single Towel Rail
800mm Brushed Nickel

Colours Available:

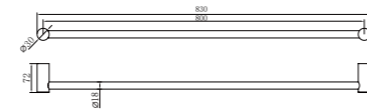

NR1630dBN

Zen SS316L Double Towel Rail
800mm Brushed Nickel

Colours Available:

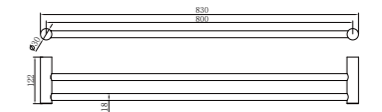

NR1630BG
Brushed Gold



NR1630GR
Graphite



NR1630BZ
Brushed Bronze



NR1630dBG
Brushed Gold



NR1630dGR
Graphite



NR1630dBZ
Brushed Bronze

NR1682BN

Zen SS316L Robe Hook
Brushed Nickel

Colours Available:
● ● ● ●

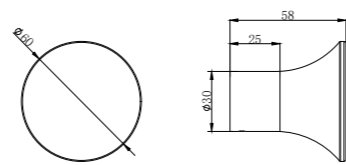

NR1686BN

Zen SS316L Toilet Roll Holder
Brushed Nickel

Colours Available:
● ● ● ●

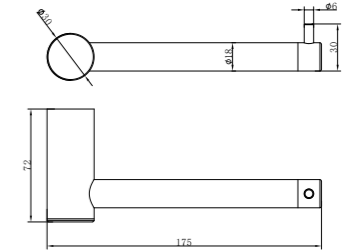

NR1682BG
Brushed Gold



NR1682GR
Graphite



NR1682BZ
Brushed Bronze



NR1686BG
Brushed Gold



NR1686GR
Graphite



NR1686BZ
Brushed Bronze

NR1680BN

Zen SS316L Hand Towel Ring
Brushed Nickel

Colours Available:
● ● ● ●

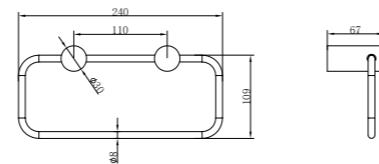

NR1680BG
Brushed Gold



NR1680GR
Graphite



NR1680BZ
Brushed Bronze



NR1680aBN

Zen SS316L Hand Towel Rail
Brushed Nickel

Colours Available:

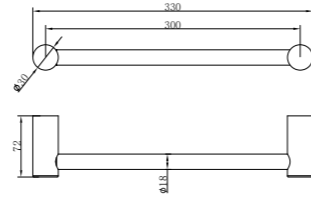
NR1687aBN

Zen SS316L Shower Shelf
Brushed Nickel

Colours Available:

NR1680aBG
Brushed Gold

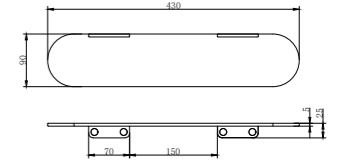

NR1680aGR
Graphite



NR1680aBZ
Brushed Bronze



NR1687aBG
Brushed Gold



NR1687aGR
Graphite



NR1687aBZ
Brushed Bronze

NR1681BN

Zen SS316L Soap Dish
Brushed Nickel

Colours Available:

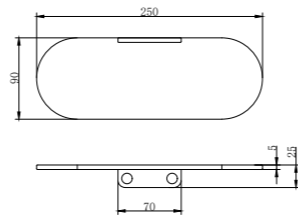
NR1681BG
Brushed Gold



NR1681GR
Graphite



NR1681BZ
Brushed Bronze



Zen Collection

Shower

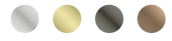

NR162205d02BN

Zen SS316L Shower On Bracket
 Brushed Nickel
 Wels Rating: 3 Star, 8.5L/Min
 Wels REG No. S18180

Colours Available:

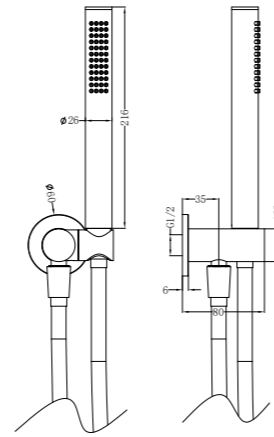
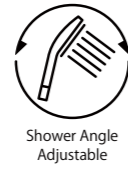
NR162205b02BN

Zen SS316L Shower Rail
 Brushed Nickel
 Wels Rating: 3 Star, 8L/Min
 Wels REG No. S18184

Colours Available:

NR162205d02BG
 Brushed Gold

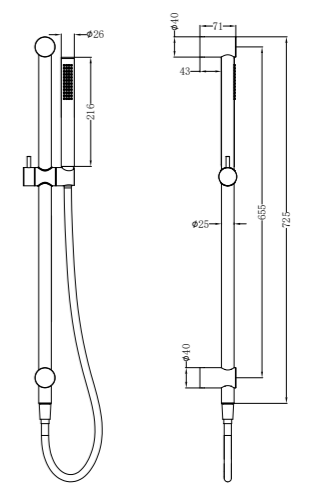

NR162205d02GR
 Graphite



NR162205d02BZ
 Brushed Bronze



NR162205b02BG
 Brushed Gold



NR162205b02GR
 Graphite



NR162205b02BZ
 Brushed Bronze

NR162205c02BN

Zen SS316L Twin Shower
Brushed Nickel
Wels Rating:
Overhead Shower 3 Star, 8L/Min,
Hand Shower 3 Star, 8L/Min
Wels REG No. S18182

Colours Available:

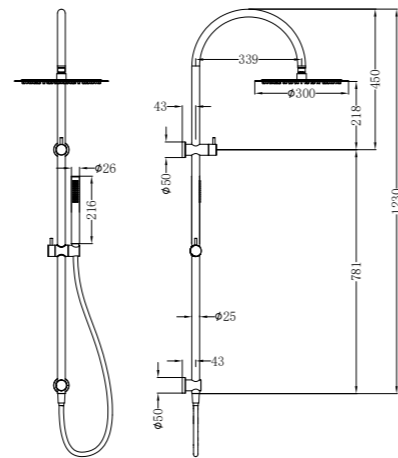

NR162205c02BG
Brushed Gold



NR162205c02GR
Graphite



NR162205c02BZ
Brushed Bronze



NR162203a02BN

Zen SS316L Freestanding Bath
Mixer Brushed Nickel
Wels Rating: 3 Star, 8L/Min
Wels REG No. S18242

Colours Available:

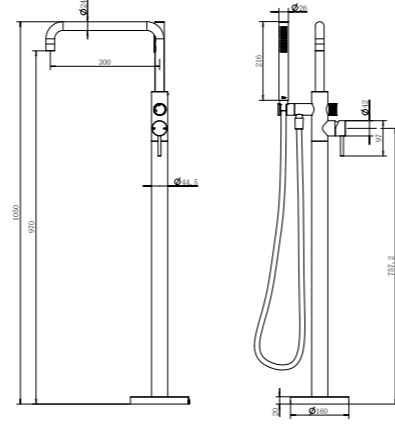

NR162203a02BG
Brushed Gold



NR162203a02GR
Graphite



NR162203a02BZ
Brushed Bronze



NR509BN

Zen SS316L Round Shower Arm
400mm Length Brushed Nickel

Colours Available:

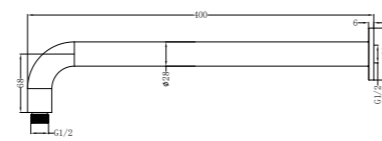

NR508041BN

Zen SS316L 300mm Round Shower
Head Brushed Nickel
Wels Rating: 3 Star, 8.5L/Min
Wels REG No. S18181

Colours Available:

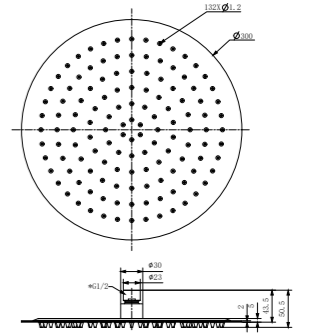

NR509BG
Brushed Gold



NR509GR
Graphite



NR509BZ
Brushed Bronze



NR508041BG
Brushed Gold



NR508041GR
Graphite



NR508041BZ
Brushed Bronze

NR510BN

Zen SS316L Round Ceiling Arm
300mm Length Brushed Nickel

Colours Available:

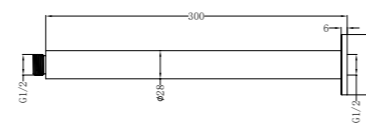

NR510BG
Brushed Gold



NR510GR
Graphite



NR510BZ
Brushed Bronze





NR162205aBN

Zen SS316L Outdoor Freestanding Shower
 Column Brushed Nickel
 Wels Rating: Overhead Shower 3 Star, 8L/Min
 Hand Shower Not Star Rated, 7L/Min
 Wels REG No. S18243

Colours Available:

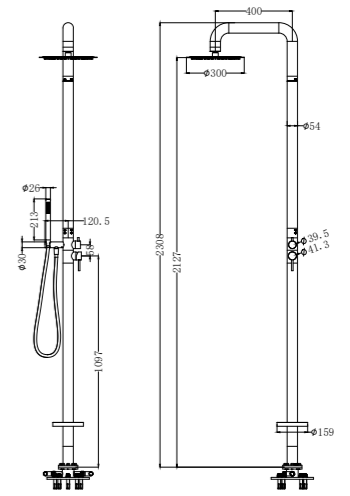

NR162205aBG
 Brushed Gold



NR162205aGR
 Graphite



NR162205aBZ
 Brushed Bronze

NR162205d01BN

Zen SS316L Shower On Bracket With Outdoor Shower Hose Brushed Nickel
Wels Rating: 3 Star, 8.5L/Min
Wels REG No. S18180

Colours Available:

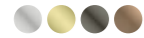

Shower Angle Adjustable

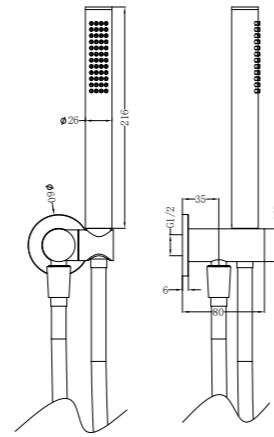

NR162205b01BN

Zen SS316L Shower Rail With Outdoor Shower Hose Brushed Nickel
Wels Rating: 3 Star, 8L/Min
Wels REG No. S18184

Colours Available:

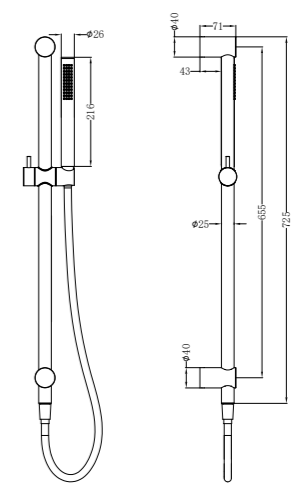

NR162205d01BG
Brushed Gold



NR162205d01GR
Graphite



NR162205d01BZ
Brushed Bronze



NR162205b01BG
Brushed Gold



NR162205b01GR
Graphite



NR162205b01BZ
Brushed Bronze

NR162205c01BN

Zen SS316L Twin Shower With Outdoor Shower Hose Brushed Nickel
 Wels Rating: Overhead Shower 3 Star, 8L/min, Hand Shower 3 Star, 8L/min
 Wels REG No. S18182

Colours Available:

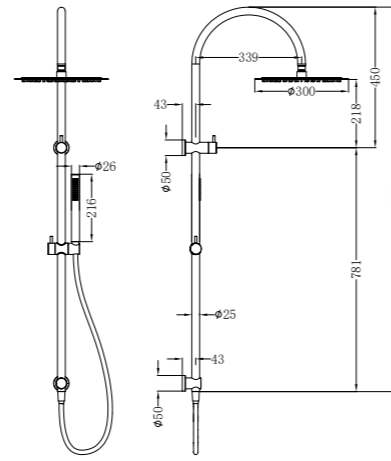
NR162203a01BN

Zen SS316L Freestanding Bath Mixer With Outdoor Shower Hose Brushed Nickel
 Wels Rating: 3 Star, 8L/Min
 Wels REG No. S18242

Colours Available:

NR162205c01BG
 Brushed Gold

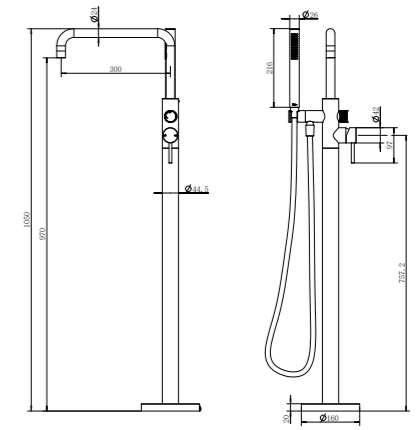

NR162205c01GR
 Graphite



NR162205c01BZ
 Brushed Bronze



NR162203a01BG
 Brushed Gold



NR162203a01GR
 Graphite



NR162203a01BZ
 Brushed Bronze

Warranty Policy

1. Warranty Coverage Statement

Nero Tapware is committed to providing high-quality products designed to meet the highest industry standards. Our warranty reflects our confidence in the durability and reliability of our products.

2. Applicability

This warranty applies to goods purchased on or after 1st May 2024, covering both Australia and New Zealand markets, in compliance with the Australian Consumer Law (ACL) and New Zealand's Consumer Guarantees Act (CGA).

3. Warranty Periods

Premium Range (Residential Use)

Category	Warranty Period(Years)	Warranty Details
Zen, Opal, Kara, York, Bianca, Mecca & Mecca Care Tapware	25 / 25 / 2	<ul style="list-style-type: none"> · 25 years replacement cartridge only · 25 years replacement products or parts on all finishes · 2 years replacement products or parts & labour
Zen, Opal, York, Bianca, Mecca & Mecca Care Showers	25 / 2	<ul style="list-style-type: none"> · 25 years replacement products or parts on all finishes · 25 years on hand showers, shower heads, Shower hoses replacement only (labour not included) · 2 years replacement products or parts & labour
Zen, Opal, York, Bianca, Mecca & Mecca Care Bathroom Accessories	25	<ul style="list-style-type: none"> · 25 years replacement products or parts on all finishes
Opal Metal Basins	25	<ul style="list-style-type: none"> · 25 years replacement products on all finishes
Heated Towel Rails	25 / 1	<ul style="list-style-type: none"> · 25 years replacement products or parts on all finishes · 1 year on power transformer replacement
Electronic Mixers / Taps & Push Taps	25 / 2	<ul style="list-style-type: none"> · 25 years replacement products or parts on all finishes · 2 years Replacement products or parts & labour

Premium Range (Commercial Use)

Category	Warranty Period(Years)	Warranty Details
Zen, Opal, Kara, York, Bianca, Mecca & Mecca Care Tapware	15 / 10 / 1	<ul style="list-style-type: none"> · 15 years replacement cartridge only · 10 years replacement products or parts on all finishes · 1 year replacement products or parts & labour
Zen, Opal, York, Bianca, Mecca & Mecca Care Showers	10 / 1	<ul style="list-style-type: none"> · 10 years replacement products or parts on all finishes · 10years on hand showers, shower heads, Shower hoses replacement only (labour not included) · 1 year replacement products or parts & labour
Zen, Opal, York, Bianca, Mecca & Mecca Care Bathroom Accessories	10	<ul style="list-style-type: none"> · 10 years replacement products or parts on all finishes
Opal Metal Basins	10	<ul style="list-style-type: none"> · 10 years replacement products on all finishes
Heated Towel Rails	10 / 1	<ul style="list-style-type: none"> · 10 years replacement products or parts on all finishes · 1 year on power transformer
Electronic Mixers / Taps & Push Taps	2 / 1	<ul style="list-style-type: none"> · 2 years replacement products or parts on all finishes · 1 year Replacement products or parts & labour

Standard Range (Residential and Commercial)

Category	Warranty Period(Years)	Warranty Details
Mixer Taps	15 / 10 / 1	<ul style="list-style-type: none"> · 15 years replacement Cartridge only · 10 years replacement products or parts on all finishes · 10 years on washing machine stops replacement only · 1 year replacement products or parts & labour
Electronic Mixers / Taps & Push Taps	2 / 1	<ul style="list-style-type: none"> · 2 years replacement products or parts on all finishes · 1 year replacement products or parts & labour
Showers	10 / 1	<ul style="list-style-type: none"> · 10 years replacement products or parts on chrome finishes · 10 years replacement products or parts on other finishes · 10 years on hand showers, shower heads, Shower hoses replacement only (labour not included) · 1 year replacement products or parts & labour
Bath Outlets	10	<ul style="list-style-type: none"> · 10 years replacement products or parts only on all finishes
Bathroom Accessories	10	<ul style="list-style-type: none"> · 10 years replacement products or parts only on all finishes
Other Accessories	10	<ul style="list-style-type: none"> · 10 years on universal pop-up waste replacement only · 10 years on bottle trap replacement only · 10 years on glass hardware replacement only · 10 years product replacement and 1 year labour on toilet push plate only · 10 years product replacement and 1 year labour on cistern only · 10 years on floor waste replacement only

4. The warranty period commences from date of purchase, or for new buildings from date of handover.

5. How to make warranty claim?

To make a warranty claim, customers must contact the Seller from which the goods were purchased or contact Nero Tapware directly. *Proof of purchase or equivalent documentation is required. (e.g. Handover documentation for new homes, Tax Invoice, Water Marks, etc.) For Australia Consumers and New Zealand Consumers,

<i>Australia</i>	<i>New Zealand</i>
☎ 03 8786 3170	☎ 02 1046 8481
✉ support@nerotapware.com.au	✉ support@nerotapware.co.nz

6. The expense of claiming on the warranty will be borne by the customer.

7. This warranty covers the repair or, at Supplier's option, replacement of any goods which are defective through faulty manufacture or materials, free of charge and labour. The Supplier reserves the right to alter, or amend this warranty offer in writing at any time.

The Supplier reserves the right to provide minor components (e.g. Handles, aerators, buttons, dress rings, spindle/cartridges and seals) as 'Parts Only' to the customer as part of replacement warranty. This warranty does not cover any claims for labour, or additional products/parts associated with allegedly faulty goods for work supplied by an outside party that is not approved in advance in writing by the Supplier.

8. For installed goods, the Supplier requires adequate access to evaluate the goods, fittings, and fixtures for any warranty claim, as well as to perform any necessary warranty repairs. The Supplier will not be liable for any consequential damage or costs if adequate access to the goods, fittings, or fixtures is not provided.

9. For discontinued or unavailable goods, the Supplier may replace the

goods with equivalent current or available goods, using best endeavors and product knowledge to match the appearance and specifications of the original goods.

10. Supplier's obligations under warranty are limited to the repair or, at Supplier's option, replacement of any product which are defective through faulty workmanship or materials. To the extent permitted by law, Supplier will not be liable for any loss to furniture, floor coverings, walls, fixtures or any consequential loss of any kind caused by any defect in the product components.

11. This warranty does not cover defects caused by or arising from any of the following:

11.1. Goods installed by a person other than a licensed plumber. This does not apply to bathroom accessories such as towel rails, shelves, etc.

11.2. Goods not installed to relevant national standards or state regulations.

11.3. Tapware exposed to water pressures and/or temperatures that exceed stated limitations as per the standard installation instructions.

Note: AS/NZS 3500.1:2003 specifies 500kPa maximum water supply pressure at any outlet within a building for new installations.

11.4. Fitting of other devices to the outlet of tapware (e.g. water filters).

11.5. Fitting of in tap body or end of line water flow regulating devices that have not been approved by Supplier.

11.6. Products used for incorrect applications, non-potable water, etc.

11.7. Damage as a result of obstruction due to inadequate flushing of system before use.

11.8. Service, repairs or other non-standard replacement parts previously undertaken without Supplier's prior written approval.

11.9. Damage to finishes by adhesives, sealant, etc.

11.10. Damage to finishes which arise from installation or postinstallation use.

11.11. Failure to observe manufacturer's care and cleaning instructions.

11.12. Improper or abusive use of product and/or damage resulting from misuse, accident or neglect.

11.13. Fair wear and tear, such as the working seals in the inlet and outlet valves, including scratching from cleaning etc.

Note: It is the installer/consumers responsibility to ensure:

- Product is not damaged prior to installation.
- They are happy with their purchase.
- The product has all of its components.
- Required maintenance is performed.

12. Should any warranty claim be made, and service attended to by the Supplier or its authorized service agent, and the fault is due to a cause expressly excluded from this warranty above; the Supplier reserves the right to charge service fee for any work carried out.

13. This warranty is in addition to the rights conferred upon customers by the Australian Consumer Law (ACL) and the Consumer Guarantees Act 1993 (CGA) in New Zealand.

14. Our goods and services come with guarantees that cannot be excluded under the Australian Consumer Law (ACL) and the Consumer Guarantees Act 1993 (CGA) in New Zealand. For major failures with the service, you are entitled to the following remedies:

15. Refund Policy:

Our goods and services come with guarantees that cannot be excluded under the Australian Consumer Law (ACL) and the Consumer Guarantees Act 1993 (CGA) in New Zealand. For major failures with the goods, you are entitled to a refund. If a failure with the goods does not amount to a major failure, you are entitled to have the failure rectified in a reasonable time. If this is not done, you are entitled to a refund for the goods. While our company acknowledges its responsibility for addressing any issues with the quality of our products, we recommend that customers contact the place of purchase for inquiries related to returns and refunds. We are committed to assist and cooperating with our distributors or retailers to resolve any issues customers may encounter with our products.

8. PERSONAL PROPERTY SECURITIES ACT

Terms related to the PPSA establish a security interest in the goods supplied and require customer actions to ensure a valid, registrable security interest.

9. RISK AND INSURANCE

Risk and insurance responsibility transfer to the Customer upon delivery or collection of goods. The Customer is responsible for obtaining necessary licenses or permits.

10. PERFORMANCE OF AGREEMENT

Delivery dates are estimates only. The Supplier endeavors to meet these estimates but is not liable for any delivery delays.

11. DELIVERY

The Supplier arranges delivery, with costs borne by the Customer. Part deliveries are permissible, and the Customer is responsible for inspecting goods upon delivery.

12. RETURNS

Returns due to change of mind are at the Supplier's discretion. Custommade or altered goods are non-returnable. A restocking fee may apply.

13. LIABILITY

The Terms exclude implied terms or warranties beyond those explicitly stated

or provided by law, particularly under the ACL and CGA, where applicable.

14. CANCELLATION

The Supplier may cancel orders if unable to deliver or provide services. Customer cancellation or suspension of orders is not binding once accepted.

15. SHORTAGES AND EXCHANGES

Claims for shortages, damages, or non-compliance must be made within 14 days. The Supplier's liability is limited to replacement, refund, or repair of the goods.

16. FORCE MAJEURE

The Supplier is not liable for failure to perform due to events beyond its control, including industrial disputes, accidents, and import or export restrictions.

17. MISCELLANEOUS

The laws of Victoria, Australia, and New Zealand govern these Terms, with non-exclusive jurisdiction of their courts. A waiver of any Term does not imply a waiver of other rights.

This comprehensive modification and supplement ensure the Terms and Conditions are applicable and enforceable in both Australia and New Zealand, accommodating the legal and commercial practices of both countries.

TAPWARE AND ACCESSORIES CARE AND CLEANING INSTRUCTIONS

Under no circumstances should you install tapware using acetone silicones.

1. Never use harsh detergents or abrasive cleaners, as these will scratch the surface. This includes organic harsh chemicals such as citrus.
2. Use of wax-based furniture cream should be avoided as this can result in a build-up of deposits, which could detract from the appearance.
3. All products should always be cleaned with care using a soft dry micro fibric cloth or a soft cloth with warm soapy water for a lifetime of use.
4. Individual products may be subject to additional or specific care and cleaning instructions. Please refer to documentation accompanying those products.

TERM AND CONDITIONS

1. DEFINITIONS

ACL refers to the Australian Consumer Law as outlined in the Competition and Consumer Act 2010 (Cth) and its associated regulations, as amended from time to time, applicable within Australia. CGA refers to the Consumer Guarantees Act 1993 and its associated regulations, as amended from time to time, applicable within New Zealand.

Consumer is defined according to both the ACL and CGA, and in determining if the Customer is a consumer, the determination is made based on the Customer's status under the Agreement according to the applicable law.

Customer means the person, jointly and severally if more than one, acquiring goods or services from the Supplier. Goods means goods supplied by the Supplier to the Customer. GST refers to the Goods and Services Tax as defined in A New Tax System (Goods and Services Tax) Act 1999 (Cth) for Australia and the Goods and Services Tax Act 1985 for New Zealand, and their associated regulations as amended.

Order means every order placed by the Customer for the purchase of goods or services from the Supplier. PPSA refers to the Personal Property Securities Act 2009 (Cth) for Australia and the Personal Property Securities Act 1999 for New Zealand, and their associated regulations as amended. Services means services supplied by the Supplier to the Customer. Supplier refers to Nero Bathrooms International Pty Ltd trading as Nero Tapware ABN 57 148 833 989 or its registered equivalent in New Zealand.

Terms refers to these Terms and Conditions of Trade, as applicable in Australia and New Zealand, incorporating any necessary modifications or supplements to comply with the laws and commercial practices of each country.

2. GOODS

The Supplier may modify, add, or remove goods in its product range without notice. This includes changes to the country of origin, materials, dimensions, and colors.

3. QUOTATION

Quotations provided by the Supplier are valid for 30 days, represent an invitation to treat, and are only valid if in writing. They may include additional terms that supersede these Terms in case of inconsistencies.

4. ORDERS

Orders placed by the Customer constitute an offer, which the Supplier may accept at its discretion. Acceptance results in a legally binding contract based on these Terms and any additional terms in the quotation.

5. PRICING

Prices are exclusive of GST and other applicable taxes or duties unless stated otherwise. A handling and delivery charge may apply to orders below a certain value.

6. PAYMENT

Payment terms include full payment within 30 days from the invoice date unless otherwise agreed. The Supplier may require payment upon delivery or a non-refundable deposit for custom orders.

7. PAYMENT DEFAULT

Default in payment allows the Supplier to suspend credit, charge interest, recover costs related to enforcement or goods recovery, and cease or suspend further supply.