

EZY

FINISHING SECTIONS



EZY cap®

The Strong And Versatile
Alternative For Stop Ends

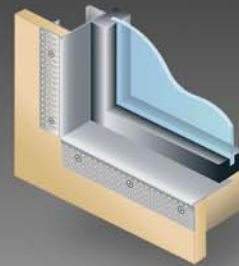

EZY reveal®

Quick And Economical
Finishing Of Reveals

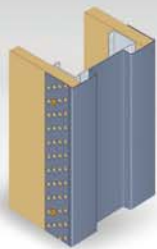

cavkit®

Flush Finish Cavity Slider Kit

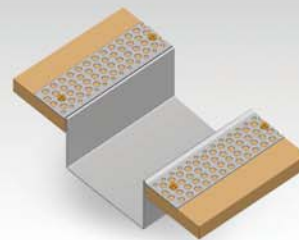

fastcap®

Custom Finishing Sections

EZY Finishing Sections



Window Reveals & Trimming



Quick, and economical finishing of reveals

EZY reveal[®]

- Designed for quick and economical finishing of reveal from 20 to 150mm.
- Manufactured from cold rolled steel providing a strong and secure reveal eliminating warping, twisting, cracking and damage from UV Rays.
- Enquire for custom size reveal lengths.



Can be used with PVC finish trim to create custom size reveals.

Part No.	EZY REVEAL	Length mm.
RA20	20mm x 0.8 Reveal Angle	3000 & 3600
RA25	25mm x 0.8 Reveal Angle	3000 & 3600
RA35	35mm x 0.8 Reveal Angle	3000 & 3600
RA50	50mm x 0.8 Reveal Angle	3000 & 3600
RA60	60mm x 0.8 Reveal Angle	3000 & 3600
RA65	65mm x 0.8 Reveal Angle	3000 & 3600
RA75	75mm x 0.8 Reveal Angle	3000 & 3600
RA80	80mm x 0.8 Reveal Angle	3000 & 3600
RA90	90mm x 0.8 Reveal Angle	3000 & 3600
RA100	100mm x 0.8 Reveal Angle	3000 & 3600
RA110	110mm x 0.8 Reveal Angle	3000 & 3600
RA120	120mm x 0.8 Reveal Angle	3000 & 3600
RA150	150mm x 0.8 Reveal Angle	3000 & 3600

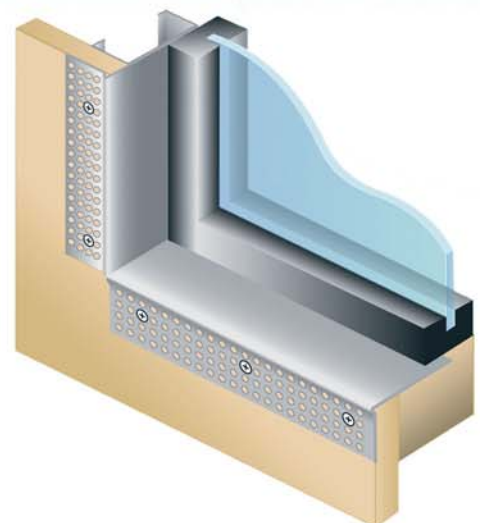

CUSTOM SIZES AVAILABLE

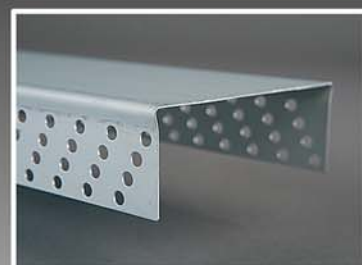

The strong and versatile alternative for stop ends

EZY cap[®]

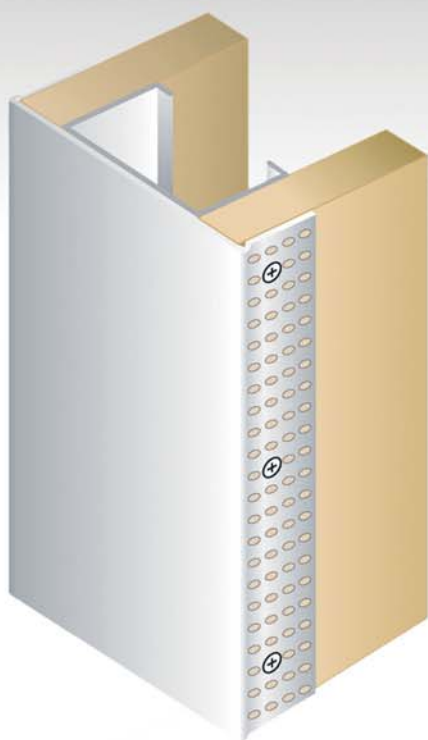

- Designed for quick and economical finishing of wall ends.
- Manufactured from cold rolled steel providing a strong and secure wall and end cap that is both durable and fast to install.
- Hard to reach wall ends made possible with EzyCap[®].
- Available in a range of sizes to suit various wall configurations.

Part No.	EZY CAP		Length mm.
FC79	79mm x 0.8 EzyCap	51 stud +13 +13	2700
			# 3000
FC86	86mm x 0.8 EzyCap	64 stud +10 +10	2700
			# 3000
FC92	92mm x 0.8 EzyCap	64 stud +13 +13	2700
			# 3000
FC98	98mm x 0.8 EzyCap	76 stud +10 +10	2700
			# 3000
FC104	104mm x 0.8 EzyCap	76 stud +13 +13	2700
			# 3000
FC112	112mm x 0.8 EzyCap	92/90 stud +10 +10	2700
			# 3000
FC118	118mm x 0.8 EzyCap	92/90 stud +13 +13	2700
			# 3000
FC127	127mm x 0.8 EzyCap	92 stud +16 +16	2700
			# 3000

Lead time and minimum quantities may apply

CUSTOM SIZES AVAILABLE

fastcap[®]

Custom Finishing Sections

Custom finishing and capping of plasterboard is made easy with Fastcaps[®] range of custom made finishing sections. Our custom design and consultancy team is ready to help design and produce a innovative solution to your requirements for any size project. Fastcaps[®] custom finishing sections make the finishing of difficult plasterboard profiles, rebates and large oversized shadowlines a dream.

Enquire now for a fast solution to all your requirements.

**CUSTOM PROFILES
MADE TO SUIT**

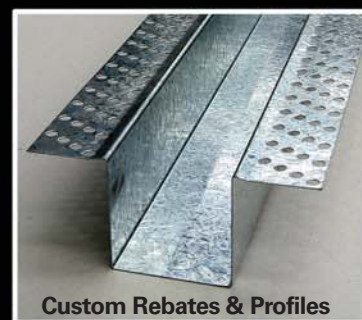
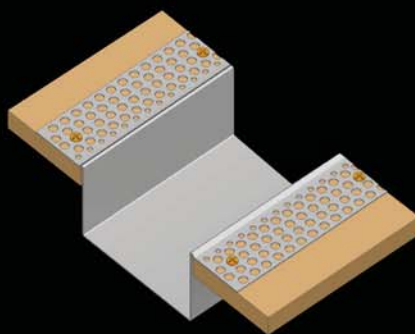

Custom Rebates & Profiles



Custom Shadowline

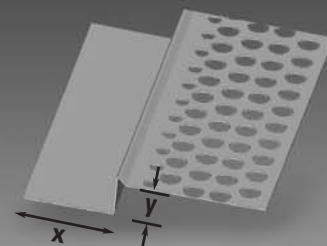
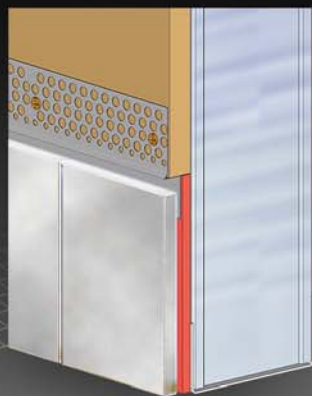

Custom Sizes Manufactured To Your Project Requirements

cavkit[®]

The Flush Finish Cavity Slider

Cavkit can be used to transform standard cavity sliders into architrave free, flush finish cavity sliders. This also complements and tones in with the Ezyjamb[®] flush finish door jamb system. The Cavkit is made up of Ezyreveal[®] and Ezycap[®] to trim and cap the plaster edges around the door penetration. Custom made closer cap can be produced to suit any specification.

For more information visit the Ezyjamb website on www.ezyjamb.com.au.

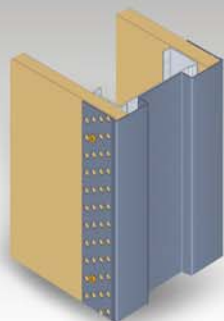

Custom Made Closer Cap

STUDCO BUILDING SYSTEMS PTY LTD
Suite 2-5, 120 Beresford Road Lilydale VIC 3140
TEL: (03) 9737 2500 FAX: (03) 9737 2555

Manufactured in Australia by:

STUDCO
BUILDING SYSTEMS