

HUNZA™ PURE
OUTDOOR
LIGHTING



OUTDOOR LIGHTING

At HUNZA, we take pride in making the finest outdoor lights in the world. Engineered in New Zealand from the best materials, they enable extraordinary outdoor lighting effects, last for decades and are environmentally sustainable.

New Zealand is renowned for its natural beauty and the extraordinary quality of its pure natural light. At HUNZA this constantly inspires us to create the finest outdoor lights in the world.

Outdoor lighting isn't just another part of our focus, it's our whole focus. We set perfection as our goal, and constantly strive to deliver it. Here's how:

Precision engineered from the finest raw materials and components. No mass production. No assembly lines.

Quality allows no room for compromise or error. We use only the finest natural copper, 316 stainless steel and New Zealand refined aluminium and there is no punching or thumping in our manufacturing process – only precision engineering. Each luminaire we produce is meticulously crafted using the latest CNC machining technology and then hand-assembled by people who take personal pride in the quality of each product.

Harnessing the science of light to enable extraordinary outdoor lighting effects.

We work on a world stage. Our design team and engineers are in touch with the world's leading technology developers and lighting designers. We understand the science of light and we create and engineer products that transform the night. Our products are designed and machined using the latest 3-D software that assures total precision and performance.

Longevity and Sustainability.

Our products are engineered to provide extraordinary durability, ease of installation and low maintenance. We provide a comprehensive range of low energy light sources for all our luminaires to help reduce power usage and cost. We also take pride in ensuring that our manufacturing processes and chemical waste disposal processes have minimal environmental impact.

We believe that when you hold a HUNZA product in your hands, you will appreciate the care, the precision and the pride we take in engineering outdoor lights that are truly the finest in the world.

Designed and Manufactured in New Zealand



Contents

Product Finishes page 6

Ground and Deck Mounted page 9

Pole Mounted page 14

Inground and Recessed page 21

Step page 32

Wall Mounted page 39

Tree Mounted page 47

Ceiling Mounted page 49

Underwater and Marine page 52

Transformers page 56

Accessories page 59

Light Sources page 63

PURE NEW



New Zealand is renowned for its natural beauty and the extraordinary quality of its pure natural light. At HUNZA this constantly inspires us to create the finest outdoor lights in the world.

ZEALAND LIGHT™

Product Finishes

Copper

The unique properties of copper have made it highly valued through the ages as much for its decorative as its functional qualities. Centuries-old cathedral roofs and spires, fountains in the great cities of Europe, and even the Statue of Liberty all bear testament to the longevity and beauty of copper.

Copper is one of only three elemental metals (the others are gold and caesium) which are not silver or grey in colour. What makes copper even more special is the way in which its colour changes and takes on a unique patina over time according to the environment it is exposed to. It is this naturally aged look - patina or verdigris - that copper is best known for and this adds a classical, timeless quality to buildings and landscape environments.

Copper starts out as a soft pink or peach colour, which gradually forms a layer of oxidation. During the initial weeks of exposure, particularly in a humid atmosphere or in areas of frequent rainfall, radical colour changes often take place with iridescent pinks, oranges and reds interspersed with brassy yellows, blues, greens and purples. During continued exposure, these colors fade and are replaced by relatively uniform russet brown shades and finally a blue-green or grey-green patina.

The patina consists of an insoluble copper carbonate, which binds tightly to the copper surface and, once formed, is highly resistant to all forms of atmospheric corrosion, therefore significantly increasing durability.

The patina process takes many years and is influenced by the presence of salt, moisture, acidity and exposure to sunlight.

In industrial and coastal atmospheres, the natural patina generally forms in from five to seven years. In rural atmospheres, where the quantity of air-borne sulphur dioxide is relatively low, patina formation may not reach a dominant stage for 10 to 14 years. In arid environments, the basic sulphate patina may never form due to the lack of sufficient moisture.

Similarly, exposed horizontal surfaces develop the patina more rapidly than sloping surfaces which, in turn, patinate more rapidly than vertical surfaces. The critical variable, in all instances, is the dwell time of moisture on the exposed surfaces.

Copper is an ideal material for outdoor luminaire construction as it has a natural, earthy appearance and excellent resistance to corrosion (rust) over a very long time. Another natural advantage of copper is that any scratches on the surface will not affect the life expectancy of the metal.

HUNZA copper luminaires are machined from very high grade, solid and hollow bar stock, (typically 10mm or $\frac{3}{8}$ "), providing exceptional longevity and requiring minimal maintenance.

Note: Solid copper luminaires age individually over time.



316 Stainless Steel

Stainless steel provides a very stylish semi-industrial look ideally suited to contemporary architecture, high-wear situations and marine environments. At HUNZA we only use 316 grade stainless steel due to its increased resistance to corrosion.

316 Stainless steel resists corrosion mainly due to the chromium content used in the steel alloy 'recipe'. Iron, the primary component of stainless steel, is very prone to oxidation (rust) in its pure form. Chromium helps to slow down the oxidation process by combining with oxygen to form a tough, adherent, inert film of chromium oxide on the steel surface. If damaged mechanically or chemically, this film is self-healing in the presence of sufficient oxygen.

Generally, an increase in chromium content improves the corrosion resistance of stainless steel. The addition of nickel raises the general corrosion resistance to a level suited to more aggressive environments. The further addition of molybdenum improves the corrosion resistance to localised effects such as pitting or scarring.

Machined from very high grade, solid and hollow bar stock, (typically 9mm

or 11/32"), our luminaires provide excellent resistance to deterioration, subject to standard stainless cleaning routines.

As its name suggests, Stainless steel stains less than ordinary steel, but it is not stain proof. Stainless steel needs regular washing to prevent surface staining, particularly in areas where it is exposed to salt-spray. In these conditions, HUNZA strongly recommends that stainless fixtures are specified with an electro-polished finish which will increase the surface protection by up to 33% and reduce the maintenance requirements.

HUNZA is possibly the only lighting manufacturer in the world to machine the swivel used in our Wall, Spike and Pole luminaires out of 316 stainless steel. Most other manufacturers use chromed brass swivels, which can deteriorate quickly in salt-laden air environments. HUNZA stainless steel luminaires are supplied with a special high-temperature grease on the trim threads to ensure easy disassembly for re-lamping and the fixtures are covered by a 10 year warranty.

Note: To maintain an attractive surface finish stainless steel luminaires require periodic cleaning. Enquire about electro polishing options.

Aluminium

Aluminium provides an excellent blend of characteristics for our outdoor luminaires, offering excellent durability and heat dissipation.

Our in-house powder coating process allows us to offer a range of ten standard powder coating colours with a high degree of UV resistance.









HUNZA aluminium luminaires are designed to last longer than a standard aluminium fixture for the following reasons:

- Our luminaires are machined from very high grade, solid and hollow bar stock, (typically 10mm or 3/8"), which means they are a very solid fixture.
- We use only very low copper (0.01%), machine-grade aluminium, which provides excellent adherence to the baked, powder coat finish.
- All aluminium components undergo a 4 step cleaning and chromating process which creates a corrosion resistant substrate.

- The finish is applied at high temperatures for a durable finish which is highly resistant to UV degradation.
- We use only the best Dulux/Orica (www.oricapowdercoatings.com) polyester powder coatings.
- HUNZA is fully ISO 9000 certified as an applicator by Dulux/Orica. Full quality records are kept throughout the process.

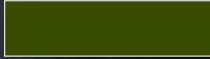
HUNZA powder coated aluminium luminaires are supplied with a special high-temperature grease on the trim threads to ensure easy disassembly for re-lamping and the fixtures are covered by a 5 year warranty.

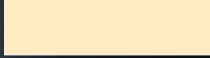
Standard colours

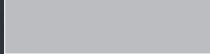
	Black (bk)
	Dark Grey (dg)
	Bronze (bz)
	Green (gn)
	Olive Green (ogr)
	White (wh)
	Birch (wb)
	Beige (rg)
	Primrose (pr)
	Silver Star (star)



HUNZA offers a wide range of luminaires designed for installation at ground level and on decks. These are very versatile, durable, low-level fixtures that blend perfectly into the landscape or deck surface and can be used for a number of illumination techniques such as uplighting, cross lighting, silhouetting, area lighting, deck lighting and path lighting.

Ground and Deck Mounted



Cat. DK

Deck Lite

The Deck Lite is an unobtrusive, low-level luminaire, which provides a soft lighting effect on decks, railings, tiled areas, brick walls, etc. It is ideal for use in deck lighting and can be supplied without the anti-glare hood if ordered as a special option.

The luminaire is fitted to the surface by means of a flange mounting system with concealed screws.

The luminaire is machined from a choice of 10mm (3/8") thick aluminium with a UV stable powder coated finish (10 standard colours), solid copper or 316 stainless steel, with UV stable polycarbonate lens and anti-glare hood. Suitable for use with a G4 bi-pin 5, 10 or 20 watt halogen lamp and is supplied with a high quality European lamp.

Accessories: Cable Joint Kit #CJK150.

HUNZA offers a comprehensive range of LED options and we regularly update the technology in line with the latest developments. Please refer to the Light Sources section of our website for the most up to date information on LED options for this luminaire.

Power Supply: HUNZA Buriable IG20 safety isolating transformer (single installation) multi installation with IG40, IG100, IG150 or IG200 safety isolating transformers or HUNZA Wall Mount series WM100 – WM300 Double Insulated Safety Isolating Transformers.

Standards: IP66

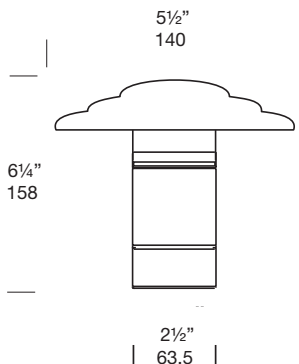

Cat. FN

Fern Lite

The Fern Lite is an unobtrusive, low-level luminaire, which provides a soft lighting effect on ground level foliage. Light is emitted on a horizontal plane through an anti-glare mesh around 360 degrees via a 5, 10 or 20 watt G4 bi-pin lamp, and does not project any vertical light.

The luminaire is machined from a choice of 10mm (3/8") thick aluminium with a UV stable powder coated finish (10 standard colours), solid copper or 316 stainless steel, with UV stable acrylic lens and anti-glare hood.

Suitable for use with a G4 bi-pin 5, 10 or 20 watt halogen lamp and is supplied with a high quality European lamp.

Accessories: Cable Joint Kit #CJK150, 300mm (12") Spike #300.

HUNZA offers a comprehensive range of LED options and we regularly update the technology in line with the latest developments. Please refer to the Light Sources section of our website for the most up to date information on LED options for this luminaire.

Power Supply: HUNZA Buriable IG20 safety isolating transformer (single installation) multi installation with IG40, IG100, IG150 or IG200 safety isolating transformers or HUNZA Wall Mount series WM100 – WM300 Double Insulated Safety Isolating Transformers.

Standards: IP66

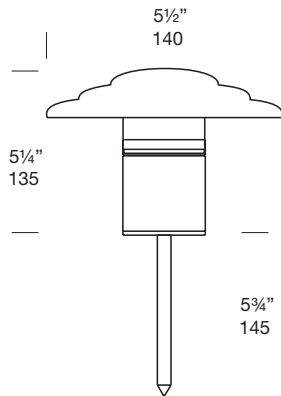

Cat. SS

Spike Spot

The Spike Spot is a fixture designed for easy insertion into the earth, and can be aimed at a bush, tree or any landscape feature.

The luminaire is machined from a choice of 10mm (3/8") thick aluminium with a UV stable powder coated finish (10 standard colours), solid copper or 316 stainless steel with a clear, tempered, stepped glass lens and high temperature silicon gaskets.

Suitable for use with a MR16 20, 35 or 50 watt lamp (maximum 35w in the USA) and is supplied with a high quality European 5000 hour lamp.

Lifetime Warranty on Lens Breakage.

Accessories: Cable Joint Kit #CJK150, Frosted Lens #LENSSTEPF, Glare Guard #GG, Hex Cell Louvre Adaptor Kit #HCL, HUNZA Super Spike #SSP/G, 300mm (12") Spike #300, IR Lamp #IRC

HUNZA offers a comprehensive range of LED options and we regularly update the technology in line with the latest developments. Please refer to the Light Sources section of our website for the most up to date information on LED options for this luminaire.

Power Supply: HUNZA Buriable IG20 or IG50 safety isolating transformer (single installation) or multi installation with IG20, IG40, IG100, IG150 or IG200 safety isolating transformers or HUNZA Wall Mount series WM100 – WM300 Double Insulated Safety Isolating Transformers.

Standards: IP66

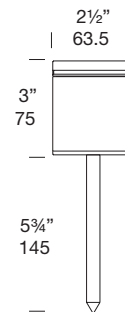



Cat. SS/A

Spike Spot Adjustable

The Spike Spot Adjustable has been designed for easy insertion into the earth, and can be aimed at a bush, tree or any landscape feature. The fully adjustable head allows 360 degree rotation and 0–90 degree elevation.

The luminaire is machined from a choice of 10mm (3/8") thick aluminium with a UV stable powder coated finish (10 standard colours), solid copper or 316 stainless steel with a clear, tempered, stepped glass lens and high temperature silicon gaskets.

Suitable for use with a MR16 20, 35 or 50 watt lamp (maximum 35w in the USA) and is supplied with a high quality European 5000 hour lamp.

Lifetime Warranty on Lens Breakage.

Accessories: Cable Joint Kit #CJK150, Frosted Lens #LENSSTEPF, Glare Guard #GG, Hex Cell Louvre Adaptor Kit #HCL, HUNZA Super Spike #SSP/G, 300mm (12") Spike #300, IR Lamp #IRC.

HUNZA offers a comprehensive range of LED options and we regularly update the technology in line with the latest developments. Please refer to the Light Sources section of our website for the most up to date information on LED options for this luminaire.

Power Supply: HUNZA Buriable IG20 or IG50 safety isolating transformer (single installation) or multi installation with IG20, IG40, IG100, IG150 or IG200 safety isolating transformers or HUNZA Wall Mount series WM100–WM300 Double Insulated Safety Isolating Transformers.

Standards: IP66

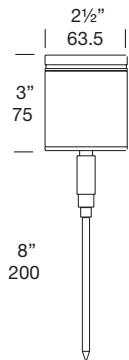

Cat. ES & ESS

Euro Spot

The Euro Spot is an extra compact luminaire designed for situations where the fixture needs to be very unobtrusive or concealed. The luminaire can be mounted in a variety of outdoor situations and can also be supplied with an integral spike (ESS, Euro Spike Spot) for easy in-ground mounting.

The Euro Spot and Euro Spike Spot use a miniature MR11 lamp to achieve the compact dimensions without compromising excellent illumination.

Machined from 45mm (1 3/4") solid copper or 316 stainless steel, with a clear, tempered, stepped glass lens, high temperature silicon gaskets and 3 metre submersible cable.

Suitable for use with a MR11 5, 10 or 20 watt lamp (10W max. in the USA).

Lifetime Warranty on Lens Breakage.

Accessories: Cable Joint Kit #CJK150, Frosted Glass #LENSEURF, Spike #S, 300mm (12") Spike #300.

HUNZA offers a comprehensive range of LED options and we regularly update the technology in line with the latest developments. Please refer to the Light Sources section of our website for the most up to date information on LED options for this luminaire.

Power Supply: HUNZA Buriable IG20 safety isolating transformer (single installation) or multi installation with IG40, IG100, IG150 or IG200 safety isolating transformers or HUNZA Wall Mount series WM100 – WM300 Double Insulated Safety Isolating Transformers.

Standards: IP66

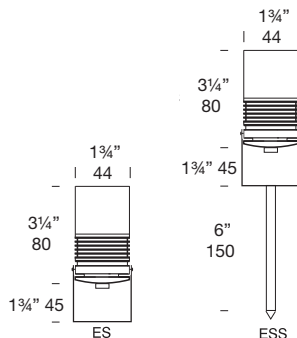

Cat. NPS

NPS Spot

The NPS Spot is ideal for illuminating bushes and trees from ground level or moon lighting from a tree using a HUNZA Tree Mount Adaptor Kit. It has a fully adjustable head allowing 360 degree rotation and 0–90 degree elevation.

The luminaire is machined from a choice of 10mm (3/8") thick aluminium with a UV stable powder coated finish (10 standard colours), solid copper or 316 stainless steel with a clear, tempered, stepped glass lens and high temperature silicon gaskets.

Suitable for use with a MR16 20, 35 or 50 watt lamp (maximum 35w in the USA) and is supplied with a high quality European 5000 hour lamp.

Lifetime Warranty on Lens Breakage.

Accessories: Cable Joint Kit #CJK150, Frosted Lens #LENSSTEPF, Glare Guard #GG, Hex Cell Louvre Adaptor Kit #HCL, HUNZA Super Spike #SSP/G, HUNZA Tree Mount Adaptor #SSP/T, IR Lamp #IRC

HUNZA offers a comprehensive range of LED options and we regularly update the technology in line with the latest developments. Please refer to the Light Sources section of our website for the most up to date information on LED options for this luminaire.

Power Supply: HUNZA Buriable IG20 or IG50 safety isolating transformer (single installation) or multi installation with IG20, IG40, IG100, IG150 or IG200 safety isolating transformers or HUNZA Wall Mount series WM100–WM300 Double Insulated Safety Isolating Transformers.

Standards: IP66

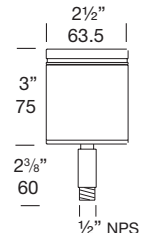



Cat. TBL

Twin Bar Lite

The Twin Bar Lite has two individual spotlights which can be aimed in two entirely different directions. Each spot has fully adjustable arm allowing 360 degree rotation. The Twin Bar Lite is ideal for wall or sign illumination using 2 x 20 watt lamps with an IG40 transformer for best economy.

The luminaire is machined from a choice of 10mm (3/8") thick aluminium with a UV stable powder coated finish (10 standard colours), solid copper or 316 stainless steel with clear, tempered, stepped glass lenses and high temperature silicon gaskets.

Suitable for use with a MR16 20, 35 or 50 watt lamp (maximum 35w in the USA) and is supplied with a high quality European 5000 hour lamp.

Lifetime Warranty on Lens Breakage.

Accessories: Cable Joint Kit #CJK150, Frosted Lens #LENSSTEPF, Glare Guard #GG, Hex Cell Louvre Adaptor Kit #HCL, HUNZA Super Spike #SSP/G, 300mm (12") Spike #300, IR Lamps #IRC.

HUNZA offers a comprehensive range of LED options and we regularly update the technology in line with the latest developments. Please refer to the Light Sources section of our website for the most up to date information on LED options for this luminaire.

Power Supply: HUNZA Buriable IG20 or IG50 safety isolating transformer (single installation) or multi installation with IG20, IG40, IG100, IG150 or IG200 safety isolating transformers or HUNZA Wall Mount series WM100 – WM300 Double Insulated Safety Isolating Transformers.

Standards: IP66

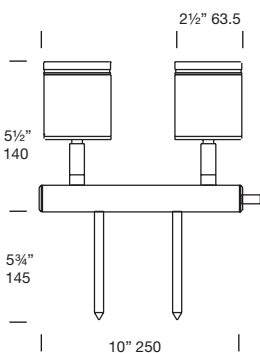

Cat. ETBL

Euro Twin Bar Lite

The Euro Twin Bar Lite is an extra compact luminaire designed for situations where the fixture needs to be very unobtrusive or concealed. Miniature MR11 lamps are used to achieve the compact dimensions without compromising excellent illumination.

The Euro Twin Bar Lite is ideal for wall or sign illumination using 2 x 20 watt (or 10 watt) lamps with an IG40 transformer for best economy.

This luminaire allows the ground level installation of two compact, individual spotlights, which can be aimed in two entirely different directions. Each spot has a fully adjustable arm allowing 360 degree rotation.

Machined from 45mm (1 3/4") solid copper or 316 stainless steel, with a clear, tempered, glass lens, high temperature silicon gaskets and 3 metre submersible cable.

Suitable for use with a MR11 5, 10 or 20 watt lamp (10W max. in the USA).

Lifetime Warranty on Lens Breakage.

Accessories: Cable Joint Kit #CJK150, Frosted Glass #LENSEURF, Spike #S, 300mm (12") Spike #300.

HUNZA offers a comprehensive range of LED options and we regularly update the technology in line with the latest developments. Please refer to the Light Sources section of our website for the most up to date information on LED options for this luminaire.

Power Supply: HUNZA Buriable IG20 safety isolating transformer (single installation) or multi installation with IG40, IG100, IG150 or IG200 safety isolating transformers or HUNZA Wall Mount series WM100 – WM300 Double Insulated Safety Isolating Transformers.

Standards: IP66

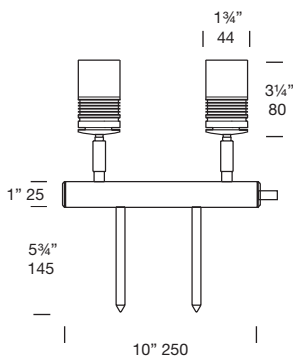

Cat. SS/MH

Spike Spot Metal Halide

The Spike Spot Metal Halide uses a 20 or 35 watt MR16 GX10 Metal Halide lamp with integral, electronic ballast. This luminaire is ideal for uplighting shrubs and small trees and is an excellent all-purpose garden light. It is easily inserted in the ground and has a fully adjustable head allowing 360 degree rotation and 0-90 degree elevation adjustment.

The Metal Halide lamp is extremely efficient, using considerably less energy and outputting 3-4 times the light of a halogen lamp. It also has a long 15,000hr operational life, much higher than the average halogen lamp life.

The luminaire is machined from a choice of 10mm (3/8") thick aluminium with a UV stable powder coated finish (10 standard colours), solid copper or 316 stainless steel with clear, tempered, stepped glass lenses and high temperature silicon gaskets.

Lifetime Warranty on Lens Breakage.

Accessories: Cable Joint Kit #CJK150, Frosted Lens #LENSSTEPF.

HUNZA offers a comprehensive range of LED options and we regularly update the technology in line with the latest developments. Please refer to the Light Sources section of our website for the most up to date information on LED options for this luminaire.

Power Supply: Ballast built in: 230/240 volt AC 50Hz Ballast built in: 120 volt AC 60 Hz (USA/Canada).

Standards: AS/NZS 60598.2.2, IP66

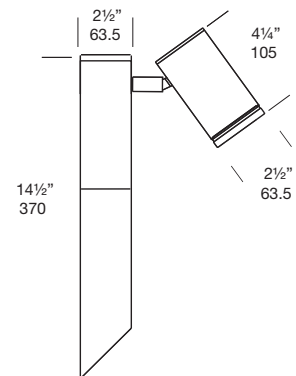



Cat. BOLMINI

Mini Bollard

The Mini Bollard is an unobtrusive, low profile luminaire, which provides a soft lighting effect on decks, railings and posts. Light is reflected through an anti-glare mesh directly onto the ground and horizontally to illuminate the surrounding area.

The luminaire is machined from a choice of 10mm (3/8") thick aluminium with a UV stable powder coated finish (10 standard colours), solid copper or 316 stainless steel, with UV-stable acrylic lens.

Suitable for use with a G4 bi-pin 5, 10 or 20 watt halogen lamp and is supplied with a high quality European lamp.

Accessories: Cable Joint Kit #CJK150, Frosted Lens #LENSBOLF

HUNZA offers a comprehensive range of LED options and we regularly update the technology in line with the latest developments. Please refer to the Light Sources section of our website for the most up to date information on LED options for this luminaire.

Power Supply: HUNZA Inground or Wall Mount
Transformer: not included.

Standards: IP66 

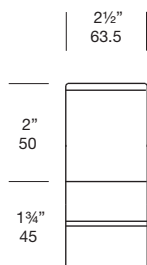

Pole Mounted

For situations where the light source needs to be elevated above the ground, HUNZA offers a variety of durable luminaires that incorporate a pole in the design. These fixtures provide an extra degree of versatility in the lighting plan and are particularly well suited to cross lighting, area lighting, silhouetting and path lighting. These pole mounted lights can be supplied either for connection to a remote transformer or with an integral 120/240 volt Retro Pole transformer for situations where the use of a remote transformer is not practical.



Cat. BOL300



Cat. BOL700, BOL700FL and BOL700/R



Cat. BOL700MH

Bollard 300

The Bollard 300 is ideal for garden edges. The lens reflects light at two angles through an anti-glare mesh directly onto the ground and horizontally to illuminate the surrounding landscape.

Constructed of tubular aluminium with a UV-stable powder coated finish or machined from solid copper or 316 stainless steel. It has a mirror-finished twin angle reflector and UV stable acrylic lens with anti-glare mesh.

Suitable for use with a MR16 20, 35 or 50 watt lamp and is supplied with a high quality European 5000 hour lamp.

Accessories: Cable Joint Kit #CJK150, 300mm (12") Spike #300, Flange Mount #FM, Fluorescent Option #FL, Anti-Glare Hood #H, RETRO transformer 120/240 volt /R (changes the luminaire to an IP56 rating), IR Lamp #/IRC.

HUNZA offers a comprehensive range of LED options and we regularly update the technology in line with the latest developments. Please refer to the Light Sources section of our website for the most up to date information on LED options for this luminaire.

Power Supply: HUNZA Buriable IG20 or IG50 safety isolating transformer (single installation) or multi installation with IG40, IG100, IG150 or IG200 safety isolating transformers or HUNZA Wall Mount series WM100 – WM300 Double Insulated Safety Isolating Transformers, RETRO 120/240 volt transformer /R.

Standards: IP56/66

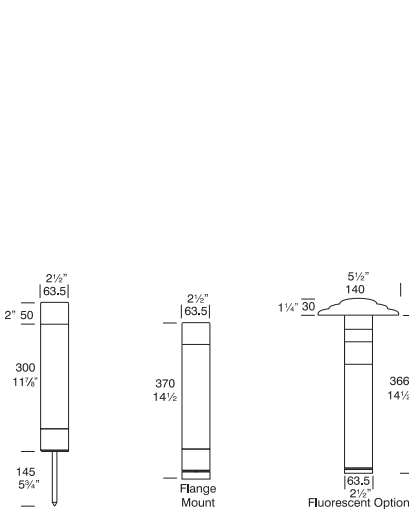

Bollard 700

The Bollard 700 is suitable for driveways, walkways, car parks, etc. The lens reflects light at two angles through an anti-glare mesh directly onto the ground and horizontally to illuminate the surrounding landscape.

Constructed of tubular aluminium with a UV-stable powder coated finish or machined from solid copper or 316 stainless steel. It has a mirror-finished twin angle reflector and UV-stable acrylic lens with anti-glare mesh.

Suitable for use with a MR16 20, 35 or 50 watt lamp and is supplied with a high quality European 5000 hour lamp.

Accessories: Cable Joint Kit #CJK150, 300mm (12") Spike #/300, Flange Mount #FM, Fluorescent Option #FL, Anti-Glare Hood #H, RETRO transformer 120/240 volt /R (changes the luminaire to an IP56 rating), IR Lamp #/IRC

HUNZA offers a comprehensive range of LED options and we regularly update the technology in line with the latest developments. Please refer to the Light Sources section of our website for the most up to date information on LED options for this luminaire.

Power Supply: HUNZA Buriable IG20 or IG50 safety isolating transformer (single installation) or multi installation with IG40, IG100, IG150 or IG200 safety isolating transformers or HUNZA Wall Mount series WM100 – WM300 Double Insulated Safety Isolating Transformers, RETRO 120/240 volt transformer /R.

Standards: IP56/66

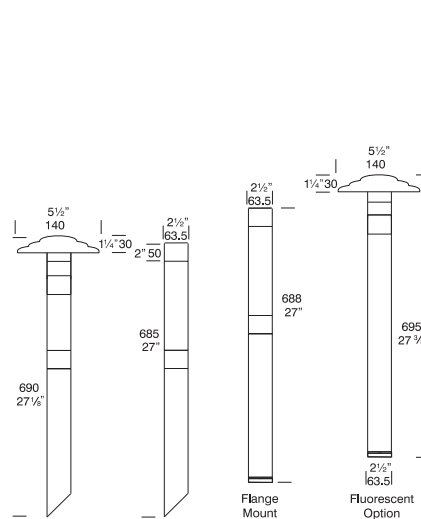

Bollard Metal Halide

The Bollard Metal Halide uses a 20 or 35 watt MR16 Metal Halide lamp with an integral, electronic ballast. This luminaire is ideal for garden edges, walkways and driveways. The lens reflects light at two angles through an anti-glare mesh directly onto the ground and horizontally to illuminate the surrounding landscape.

The Metal Halide lamp is extremely efficient, using considerably less energy and outputting 3-4 times the light of a halogen lamp. It has a long 15,000 hour operational life, much higher than the halogen lamp life.

Constructed of tubular aluminium with a UV-stable powder coated finish or machined from solid copper or 316 stainless steel. It has a mirror-finished twin angle reflector and UV stable acrylic lens with anti-glare mesh.

Accessories: Cable Joint Kit #CJK150, Frosted Lens #LENSBOLF, Anti-Glare hood #H, Flange Mount #FM

HUNZA offers a comprehensive range of LED options and we regularly update the technology in line with the latest developments. Please refer to the Light Sources section of our website for the most up to date information on LED options for this luminaire.

Power Supply: Ballast built in: 230/240 volt AC 50 Hz Ballast built in: 120 volt AC 60 Hz (USA/Canada)

Standards: AS/NZS 60598.2.2, IP66

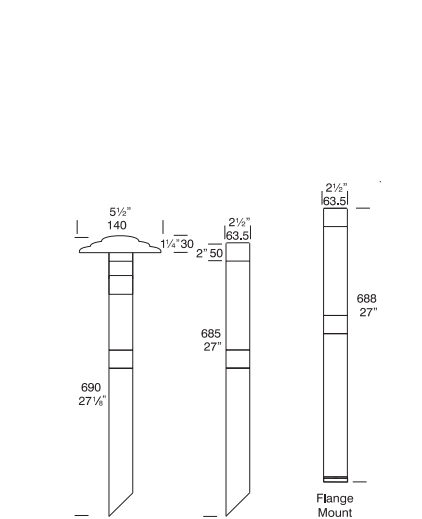



Cat. PS



Cat. ESPL and ESPL/R

Pole Spot

The Pole Spot is ideal for path lighting as well as tree lighting, or the head may be aimed downward to completely stop upward light. The Pole Spot has a single spotlight which can be aimed in any single direction. The fitting has a fully adjustable head which allows for 360 degree rotation and 0–90 degree elevation.

The luminaire is machined from a choice of 10mm (3/8") thick aluminium with a UV stable powder coated finish (10 standard colours), solid copper or 316 stainless steel with a clear, tempered, stepped glass lens and high temperature silicon gaskets.

Lifetime Warranty on Lens Breakage.

Accessories: Cable Joint Kit #CJK150, Frosted Lens #Cat. LENSSTEPF, Glare Guard #Cat. GG, Hex Cell Louvre Adapter #Cat. HCL.

HUNZA offers a comprehensive range of LED options and we regularly update the technology in line with the latest developments. Please refer to the Light Sources section of our website for the most up to date information on LED options for this luminaire.

Power Supply: HUNZA Inground or Wall Mount Transformer: not included

Standards: IP66

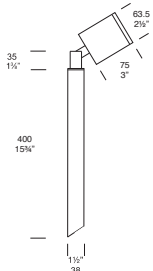

Euro Single Pole Lite

The Euro Single Pole Lite is an extra-compact luminaire designed for situations where the fixture needs to be very unobtrusive or concealed. The luminaire can be mounted in a variety of outdoor situations.

The Euro Single Pole Lite is ideal for path lighting as well as tree lighting, or the head may be aimed downward to stop upward light altogether.

The luminaire has a fully adjustable arm allowing 360 degree rotation and 0–90 degree rotation.

HUNZA Euro fixtures use a miniature MR11 lamp to achieve the compact dimensions without compromising excellent illumination.

Machined from 45mm (1 3/4") solid copper or 316 stainless steel, with a clear, tempered, glass lens, and high temperature silicon gaskets. The fitting is mounted onto a head which is secured by a stainless steel grub screw to an 850mm (33") pole.

Suitable for use with a MR11 5, 10 or 20 watt lamp (10W max. in the USA)

Lifetime Warranty on Lens Breakage.

Accessories: Cable Joint Kit #CJK150, Frosted Lens #LENSEURF, RETRO 120/240 volt transformer /R (changes the luminaire to an IP56 rating).

HUNZA offers a comprehensive range of LED options and we regularly update the technology in line with the latest developments. Please refer to the Light Sources section of our website for the most up to date information on LED options for this luminaire.

Power Supply: HUNZA Buriable IG20 or IG50 safety isolating transformer (single installation) or multi installation with IG40, IG100, IG150 or IG200 safety isolating transformers or HUNZA Wall Mount series WM100–WM300 Double Insulated Safety Isolating Transformers, RETRO 120/240 volt transformer /R

Standards: IP56/66

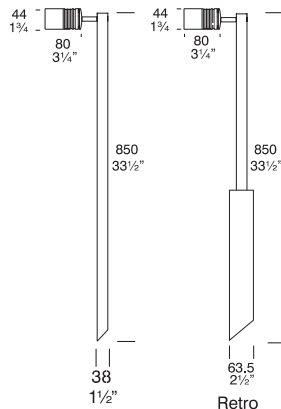



Cat. ETPL and ETPL/R

Euro Twin Pole Lite

The Euro Twin Pole Lite is an extra-compact luminaire designed for situations where the fixture needs to be very unobtrusive or concealed. The luminaire can be mounted in a variety of outdoor situations.

The Euro Twin Pole Lite is ideal for path lighting as well as tree lighting, or the heads may be aimed downward to stop upward light altogether.

HUNZA Euro fixtures use a miniature MR11 lamp to achieve the compact dimensions without compromising excellent illumination.

The Euro Twin Pole Lite has two fully adjustable arms allowing 360 degree rotation and 0–90 degree rotation.

Machined from 45mm (1 3/4") solid copper or 316 stainless steel, with a clear, tempered, glass lens, and high temperature silicon gaskets. The fitting is mounted onto a head which is secured by a stainless steel grub screw to an 850mm (33") pole.

Suitable for use with a MR11 5, 10 or 20 watt lamp (10W max. in the USA).

Lifetime Warranty on Lens Breakage.

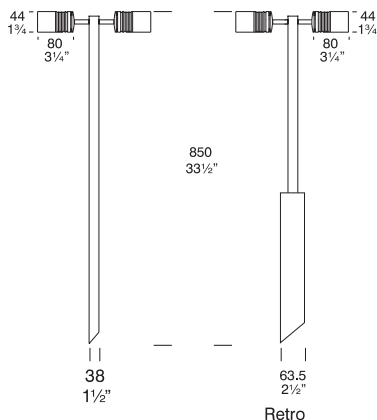

Accessories: Cable Joint Kit #CJK150, Frosted Lens #LENSEURF, RETRO 120/240 volt transformer /R (changes the luminaire to an IP56 rating).

HUNZA offers a comprehensive range of LED options and we regularly update the technology in line with the latest developments. Please refer to the Light Sources section of our website for the most up to date information on LED options for this luminaire.

Power Supply: HUNZA Buriable IG20 or IG50 safety isolating transformer (single installation) or multi installation with IG40, IG100, IG150 or IG200 safety isolating transformers or HUNZA Wall Mount series WM100 – WM300 Double Insulated Safety Isolating Transformers, RETRO 120/240 volt transformer /R

Standards: IP56/66



Cat. SPL and SPL/R

Single Pole Lite

The Single Pole Lite is ideal for path lighting as well as tree lighting, or the head may be aimed downward to stop upward light altogether.

The fixture has a fully adjustable arm which allows the single spotlight to be aimed in any direction.

The Single Pole Lite is machined from a choice of 10mm (3/8") thick aluminium with a UV stable powder coated finish (10 standard colours), solid copper or 316 stainless steel with a clear, tempered, stepped glass lens and high temperature silicon gaskets.

Suitable for use with a MR16 20, 35 or 50 watt lamp (maximum 35w in the USA) and is supplied with a high quality European 5000 hour lamp.

Lifetime Warranty on Lens Breakage.

Accessories: Cable Joint Kit #CJK150, Frosted Lens #LENSSTEPF, Glare Guard #GG, Hex Cell Louvre Adaptor #HCL, RETRO 120/240 volt transformer /R (changes the luminaire to an IP56 rating).

HUNZA offers a comprehensive range of LED options and we regularly update the technology in line with the latest developments. Please refer to the Light Sources section of our website for the most up to date information on LED options for this luminaire.

Power Supply: HUNZA Buriable IG20 or IG50 safety isolating transformer (single installation) or multi installation with IG40, IG100, IG150 or IG200 safety isolating transformers or HUNZA Wall Mount series WM100 – WM300 Double Insulated Safety Isolating Transformers, RETRO 120/240 volt transformer /R.

Standards: IP56/66

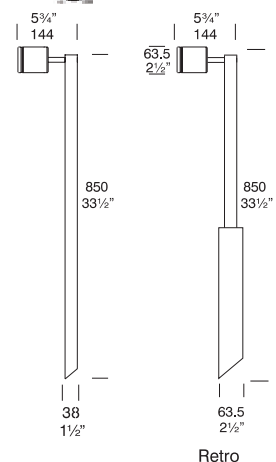



Cat. TPL and TPL/R



Cat. TG and TG/R

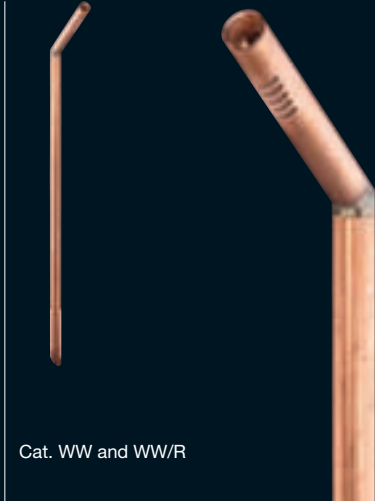

Cat. WW and WW/R

Twin Pole Lite

The Twin Pole Lite has two individual spotlights which can be aimed in two entirely different directions. Each light has fully adjustable arms allowing 360 degree rotation and 0–90 degree elevation.

Twin Pole Lites are ideal for path lighting as well as tree lighting, using 2 x 20 watt lamps with a IG40 transformer for best economy.

The luminaire is machined from a choice of 10mm (3/8") thick aluminium with a UV stable powder coated finish (10 standard colours), solid copper or 316 stainless steel with a clear, tempered, stepped glass lens and high temperature silicon gaskets.

Suitable for use with a MR16 20, 35 or 50 watt lamp (maximum 35w in the USA) and is supplied with a high quality European 5000 hour lamp.

Lifetime Warranty on Lens Breakage.

Accessories: Cable Joint Kit #CJK150, Frosted Lens #LENSSTEPF, Glare Guard #GG, Hex Cell Louvre Adaptor #HCL, RETRO 120/240 volt transformer /R (changes the luminaire to an IP56 rating), IR Lamp #/IRC

HUNZA offers a comprehensive range of LED options and we regularly update the technology in line with the latest developments. Please refer to the Light Sources section of our website for the most up to date information on LED options for this luminaire.

Power Supply: HUNZA Buriable IG20 or IG50 safety isolating transformer (single installation) or multi installation with IG40, IG100, IG150 or IG200 safety isolating transformers or HUNZA Wall Mount series WM100 – WM300 Double Insulated Safety Isolating Transformers, RETRO 120/240 volt transformer /R

Standards: IP56/66

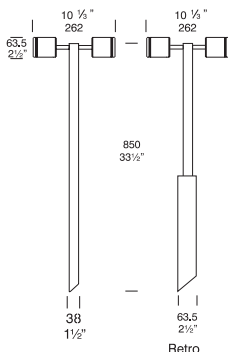

Twig Lite

The Twig Lite has a subtle, unobtrusive appearance that allows it to blend into taller foliage while providing soft, effective landscape illumination.

The luminaire has a frosted glass lens to reduce glare and is best operated with a 10 or 20 watt halogen lamp.

Available in solid copper and stainless steel. Suitable for use with a G4 bi-pin 5, 10 or 20 watt halogen lamp (10W max. in the USA) and is supplied with a high quality European lamp.

Accessories: Cable Joint Kit #CJK150, HUNZA Super Spike #SSP/G, RETRO transformer 120/240 volt /R.

HUNZA offers a comprehensive range of LED options and we regularly update the technology in line with the latest developments. Please refer to the Light Sources section of our website for the most up to date information on LED options for this luminaire.

Power Supply: HUNZA Buriable IG20 or IG50 safety isolating transformer (single installation) or multi installation with IG40, IG100, IG150 or IG200 safety isolating transformers or HUNZA Wall Mount series WM100 – WM300 Double Insulated Safety Isolating Transformers, RETRO 120/240 volt transformer /R

Standards: IP44

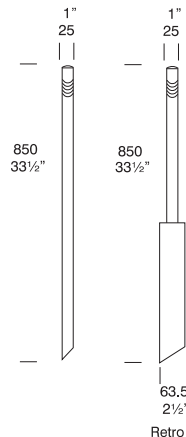

Walkway Lite

The Walkway Lite has a subtle, unobtrusive appearance that allows it to blend into a landscape while providing soft, effective pathway illumination without glare.

The luminaire has a frosted glass lens to further reduce glare and is best operated with a 5 watt or 10 watt halogen lamp.

Constructed from solid copper with a solid brass elbow and stainless steel grub screws, and is only available in these materials.

Suitable for use with a G4 bi-pin 5, 10, 20 watt lamp (10 watt max. in the USA) and is supplied with a high quality European lamp.

Accessories: Cable Joint Kit #CJK150, HUNZA Super Spike #SSP/G, RETRO transformer 120/240 volt /R.

HUNZA offers a comprehensive range of LED options and we regularly update the technology in line with the latest developments. Please refer to the Light Sources section of our website for the most up to date information on LED options for this luminaire.

Power Supply: HUNZA Buriable IG20 or IG50 safety isolating transformer (single installation) or multi installation with IG40, IG100, IG150 or IG200 safety isolating transformers or HUNZA Wall Mount series WM100 – WM300 Double Insulated Safety Isolating Transformers, RETRO 120/240 volt transformer /R

Standards: IP44

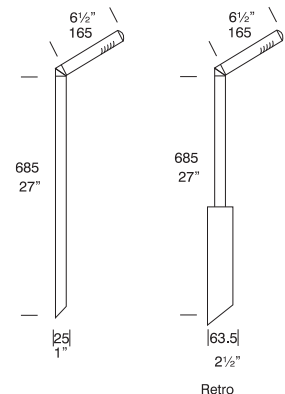



Cat. TL and TL/R

Tier Lite

The Tier Lite is designed for illuminating medium level foliage. Mounted on a 700mm (27") pole to provide a soft pool of light suitable for a wide variety of landscape situations.

The luminaire provides 360 degree illumination on a horizontal plane and does not project any vertical light.

Machined from 10mm (3/8") thick aluminium with a UV stable powder coated finish or solid copper with high temperature silicon gaskets, UV stable acrylic lens and anti-glare hood.

Suitable for use with a G4 bi-pin 5, 10 or 20 watt halogen lamp and is supplied with a high quality European lamp.

A 110/240 volt fluorescent option is available, which offers excellent light output, low energy usage and very low heat generation.

Accessories: Cable Joint Kit #CJK150, HUNZA Super Spike #SSP/G, Fluorescent Option #FL, RETRO 120/240 volt transformer /R (changes the luminaire to an IP56 rating).

HUNZA offers a comprehensive range of LED options and we regularly update the technology in line with the latest developments. Please refer to the Light Sources section of our website for the most up to date information on LED options for this luminaire.

Power Supply: HUNZA Buriable IG20 or IG50 safety isolating transformer (single installation) or multi installation with IG40, IG100, IG150 or IG200 safety isolating transformers or HUNZA Wall Mount series WM100 – WM300 Double Insulated Safety Isolating Transformers, RETRO 120/240 volt transformer /R.

Standards: IP56/66

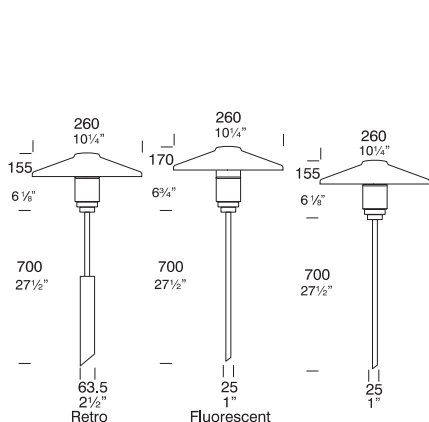

Cat. BL and BL/R

Border Lite

The Border Lite is ideal for path lighting giving a wide spread of light with no upward projection.

This luminaire has a fully adjustable arm allowing 360 degree rotation and 0–90 degree elevation.

The fixture is solidly constructed from cast aluminium with a UV stable powder coated finish. The Border Lite has a tempered glass lens and a silicon gasket. The fitting is mounted onto a head, which is secured by a stainless steel grub screw to an 850mm (33") pole.

Suitable for use with a G4 bi-pin 20 watt lamp or GY6.35 bi-pin 35, 50 watt lamp (20w max. in the USA) and is supplied with a high quality European lamp.

Lifetime Warranty on Lens Breakage.

Accessories: Cable Joint Kit #CJK150, RETRO 120/240 volt transformer /R (changes the luminaire to an IP56 rating).

HUNZA offers a comprehensive range of LED options and we regularly update the technology in line with the latest developments. Please refer to the Light Sources section of our website for the most up to date information on LED options for this luminaire.

Power Supply: HUNZA Buriable IG20 or IG50 safety isolating transformer (single installation) or multi installation with IG40, IG100, IG150 or IG200 safety isolating transformers or HUNZA Wall Mount series WM100 – WM300 Double Insulated Safety Isolating Transformers, RETRO 120/240 volt transformer /R.

Standards: IP56/66

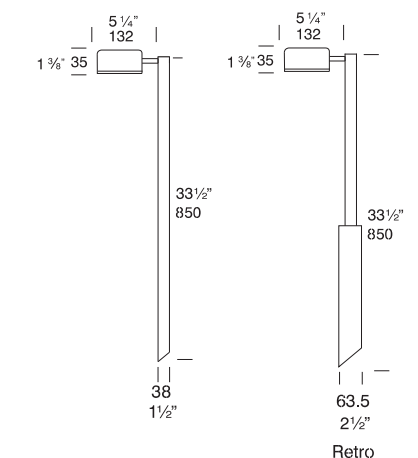

Cat. BLT and BLT/R

Border Lite Twin

The Border Lite Twin has two individual heads which can be aimed in different directions, making it ideal for path lighting giving a wide spread of light with no upward projection. Each light has a fully adjustable arm allowing 360 degree rotation and 0–90 degree elevation. The luminaire has a frosted glass lens to further reduce glare.

The Retro, which is a mains option, avoids the need to bury a transformer. The 110/240–12 volt electronic transformer is built into the pole and is a double insulated safety isolating transformer, this changes the luminaire to an IP56 rating.

This luminaire is equipped with HUNZA's Anti-Syphon (not Retro luminaires) system which has been designed to counter the problem of wicking (siphoning) of water through the supply cable into the lamp housing, causing water to condense and dramatically shorten the life of the lamp, lamp holder and luminaire.

Lifetime Warranty on Lens Breakage.

Accessories: Cable Joint Kit #CJK150, Clear Lens #Cat. LENSBLCL, Retro transformer 110/240–12 volt /R

HUNZA offers a comprehensive range of LED options and we regularly update the technology in line with the latest developments. Please refer to the Light Sources section of our website for the most up to date information on LED options for this luminaire.

Power Supply: HUNZA Inground or Wall Mount Transformer: not included.

Standards: IP56/IP66

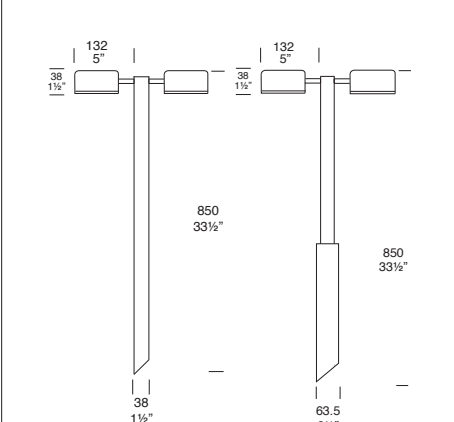



Cat. SPL/MH



Cat. TPL/MH

Single Pole Lite Metal Halide

The Single Pole Lite Metal Halide is ideal for path lighting as well as tree lighting, and the head may be aimed downward to eliminate vertical light. The fitting has a single spotlight which can be aimed in any direction as it has a fully adjustable arm allowing 360 degree rotation and 0-90 degree elevation.

Metal Halide lamps are highly energy efficient light sources using less energy and outputting 3-4 times the light of a halogen lamp. This luminaire uses a MR16 GX10 lamp.

The luminaire is machined from 10mm (3/8") thick aluminium with a UV stable powder coated finish, solid copper or 316 stainless steel with a clear, tempered, stepped glass lens and high temperature silicon gaskets.

Lifetime Warranty on Lens Breakage.

Accessories: Cable Joint Kit #CJK150, Frosted Lens #Cat. LENSTEPF

Power Supply: Ballast built in: 230/240 volt AC 50Hz
Ballast built in: 120 volt AC 60 Hz (USA/Canada).

Standards: AS/NZS 60598 2.2, IP66 

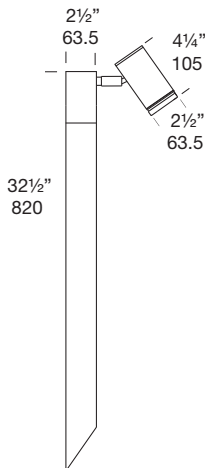

Twin Pole Lite Metal Halide

The Twin Pole Lite Metal Halide has two spotlights aimed in two entirely different directions. The fitting has adjustable arms which allow 360 degree rotation and 0-90 degree elevation.

This luminaire is ideal for path lighting as well as tree lighting and the head may be aimed downward to eliminate vertical light.

Metal Halide lamps are highly energy efficient light sources using less energy and outputting 3-4 times the light of a halogen lamp. This luminaire uses a MR16 GX10 20 or 35 watt lamp.

The luminaire is machined from 10mm (3/8") thick aluminium with a UV stable powder coated finish, solid copper or 316 stainless steel with a clear, tempered, stepped glass lens and high temperature silicon gaskets.

Lifetime Warranty on Lens Breakage.

Accessories: Cable Joint Kit #CJK150, Frosted Lens #Cat. LENSTEPF

Power Supply: Ballast: Electronic built in 230/240 volt ac 50Hz.

Standards: AS/NZS 60598 2.2, IP66 

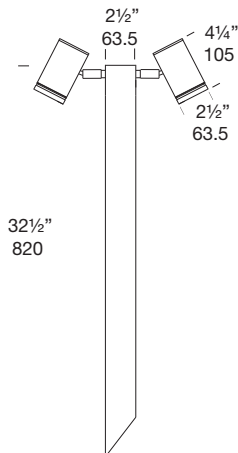

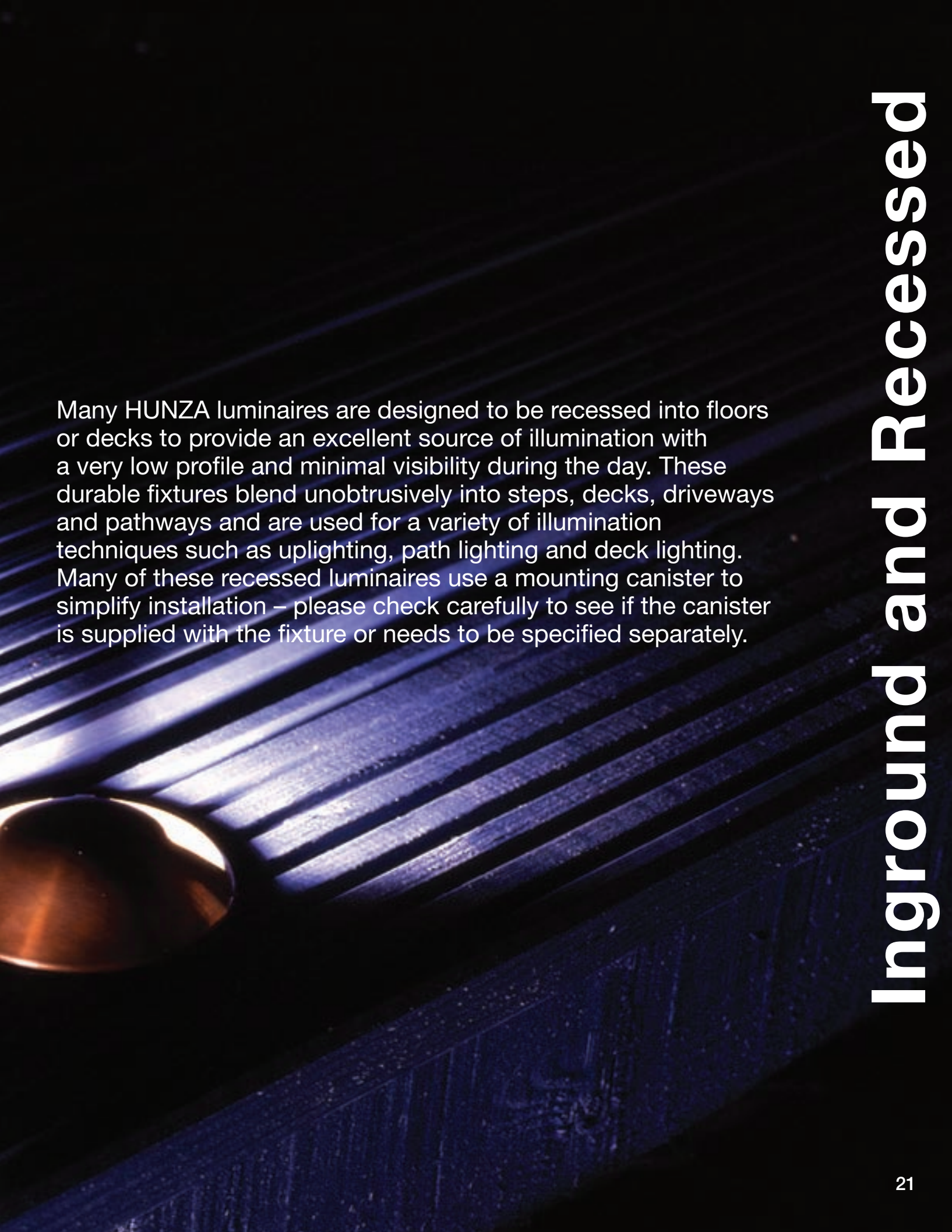

Many HUNZA luminaires are designed to be recessed into floors or decks to provide an excellent source of illumination with a very low profile and minimal visibility during the day. These durable fixtures blend unobtrusively into steps, decks, driveways and pathways and are used for a variety of illumination techniques such as uplighting, path lighting and deck lighting. Many of these recessed luminaires use a mounting canister to simplify installation – please check carefully to see if the canister is supplied with the fixture or needs to be specified separately.

Inground and Recessed



Cat. FLSP



Cat. FLGR



Cat. FLCL



Cat. FLCR



Cat. FLLU



Cat. FLDK

Floor Lite

The Floor Lite has an 88mm (3½") flange which has an extremely low profile and can be walked upon without damaging the luminaire. There are five flange designs: Clover #FLCL, Grill #FLGR, Louvre #FLLU (45 degree angle), Spot #FLSP (spot also available in copper), Cross #FLCR.

The luminaire is held into the aluminium mounting canister by two 'O' rings that allow the luminaire to be removed for lamp replacement, hence there are no mounting screws in the flange to spoil the aesthetics of the luminaire.

The Floor Lite is machined from 9mm (⅜") thick 316 stainless steel and has a tempered glass lens with high temperature silicon gaskets. This luminaire is complete with an aluminium mounting canister, and is supplied with a 20 watt lamp to avoid undue heat generated by the lamp.

Suitable for use with a MR16 20 watt halogen lamp and is supplied with a high quality European 5000 hour lamp.

A GU10 option can be specified with a 25 watt lamp. Note that operating temperature does increase and this changes the luminaire to an IP66 rating.

A 110/240 volt fluorescent option is available, which offers excellent light output, low energy usage and very low heat generation. This option changes the luminaire to an IP66 rating.

Lifetime Warranty on Lens Breakage.

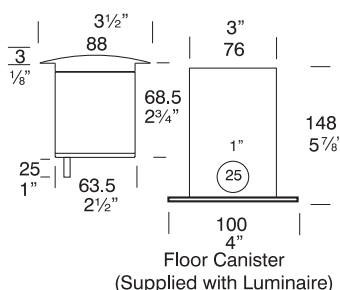

Accessories: Cable Joint Kit #CJK150, Frosted Lens #LENSSTEPF, Hex Cell Louvre Adaptor #HCL, Fluorescent Canister PVC #FLUCAN, IR Lamp #IRC

HUNZA offers a comprehensive range of LED options and we regularly update the technology in line with the latest developments. Please refer to the Light Sources section of our website for the most up to date information on LED options for this luminaire.

Power Supply: HUNZA Buriable IG20 safety isolating transformer (single installation) or multi-installation with IG40, IG100, or IG200 safety isolating transformers, HUNZA Wall Mount series WM100 – WM300 Double Insulated Safety Isolating Transformers or H20 for internal installation only.

Standards: CE, EN60598, IP66/68 

Floor Lite Dark Lighter

The Floor Lite Dark Lighter has a lamp that is recessed 50mm (2") below the lens to provide a compact up-lighter with minimal glare. Glare control has been further enhanced by the inclusion of a hex cell louvre and matt black interior. The Dark Lighter version of the Floor Lite has an extremely low profile (3mm or ⅛") and can be walked on without damaging the luminaire.

There are five flange designs available: Spot #SP (spot only available in copper), Clover #CL, Cross #CR, Grill #GR and Louvre #LU (45 degree angle).

The luminaire is supplied with an aluminium mounting canister and a high quality European 5000 hour, 20 watt MR16 lamp to avoid undue heat build-up at the lens surface. The fixture is held into the aluminium mounting canister by two 'O' rings, which allow easy removal for lamp replacement, hence there are no mounting screws in the flange to spoil the aesthetics of the luminaire.

The Floor Lite is machined from 9mm (⅜") thick 316 stainless steel and has a tempered, stepped glass lens with high temperature silicon gaskets. There is also a solid copper version available with a Spot flange only.

A GU10 option can be specified with a 25 watt lamp – note that operating temperature does increase and this changes the luminaire to an IP66 rating.

Lifetime Warranty on Lens Breakage.

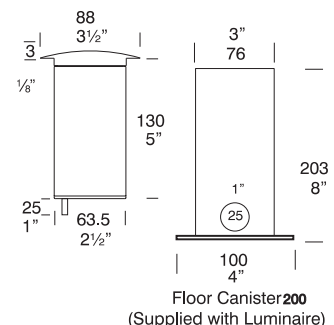



Cat. FLDKSQ

Accessories: Cable Joint Kit #CJK150, Frosted Lens #LENSSTEPF, Hex Cell Louvre Adaptor #HCL, Floor Canister 200 #FLCAN200, Fluorescent Canister PVC #FLUCAN, IR Lamp #/IRC

HUNZA offers a comprehensive range of LED options and we regularly update the technology in line with the latest developments. Please refer to the Light Sources section of our website for the most up to date information on LED options for this luminaire.

Power Supply: HUNZA Buriable IG20 safety isolating transformer (single installation) or multi-installation with IG 40, IG100, or IG200 safety isolating transformers, HUNZA Wall Mount series WM100—WM300 Double Insulated Safety Isolating Transformers or H20 for internal installation only.

Standards: CE, EN60598, IP66/68 

Floor Lite Dark Lighter Square

The Floor Lite Dark Lighter Square has a lamp that is recessed 50mm (2") below the lens to provide a compact up-lighter with minimal glare. Glare control has been further enhanced by the inclusion of a hex cell louvre and matt black interior. The fixture has an extremely low profile (7mm or 1/4") and can be walked on without damaging the luminaire.

There are five flange designs available: Spot #SP (spot also available in copper), Clover #CL, Cross #CR, Grill #GR and Louvre #LU (45 degree angle).

The luminaire is supplied with an aluminium mounting canister and a high quality European 5000 hour, 20 watt MR16 lamp to avoid undue heat build-up at the lens surface. The fixture is held into the aluminium mounting canister by two 'O' rings, which allow easy removal for lamp replacement, hence there are no mounting screws in the flange to spoil the aesthetics of the luminaire.

The Floor Lite is machined from 9mm (11/32") thick 316 stainless steel and has a tempered, stepped glass lens with high temperature silicon gaskets. There is also a solid copper version available in the spot flange.

A GU10 option can be specified with a 25 watt lamp – note that operating temperature does increase and this changes the luminaire to an IP66 rating.

Lifetime Warranty on Lens Breakage

Accessories: Cable Joint Kit #CJK150, Frosted Lens #LENSSTEPF, Hex Cell Louvre Adaptor #HCL, Fluorescent Canister PVC #FLUCAN, IR Lamp #/IRC

HUNZA offers a comprehensive range of LED options and we regularly update the technology in line with the latest developments. Please refer to the Light Sources section of our website for the most up to date information on LED options for this luminaire.

Power Supply: HUNZA Buriable IG20 safety isolating transformer (single installation) or multi- installation with IG40, IG100, or IG200 safety isolating transformers, HUNZA Wall Mount series WM100 - WM300 Double Insulated Safety Isolating Transformers or H20 for internal installation only.

Standards: CE, EN60598, IP66/68 

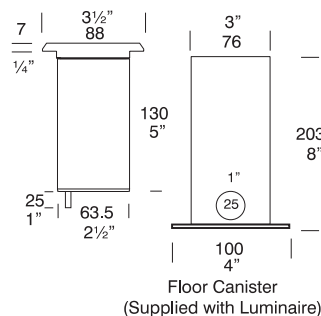



Cat. FLSPSQ



Cat. FLCLSQ



Cat. FLCRSQ



Cat. FLGLSQ



Cat. FLLUSQ



Cat. DWL

Floor Lite Square

The Floor Lite Square has an 88mm (3½") flange which has an extremely low profile (3mm or ⅛") and can be walked upon without damaging the luminaire. There are five flange designs: Clover #CL; Grill #GR; Louvre #LU (45 degree angle); Spot #SP (Spot also available in copper); Cross #CR

The luminaire is held into the aluminium mounting canister by two 'O' rings that allow the luminaire to be removed for lamp replacement, hence there are no mounting screws in the flange to spoil the aesthetics of the luminaire.

The Floor Lite Square is machined from 9mm (⅜") thick 316 stainless steel and has a tempered glass lens with high temperature silicon gaskets. This luminaire is complete with an aluminium mounting canister, and is supplied with a 20 watt lamp to avoid undue heat generated by the lamp.

Suitable for use with a MR16 20 watt halogen lamp and is supplied with a high quality European 5000 hour lamp.

A 110/240 volt fluorescent option is available, which offers excellent light output, low energy usage and very low heat generation. This option changes the luminaire to an IP66 rating.

A GU10 option can be specified with a 25 watt lamp – note that operating temperature does increase and this changes the luminaire to an IP66 rating.

Lifetime Warranty on Lens Breakage.

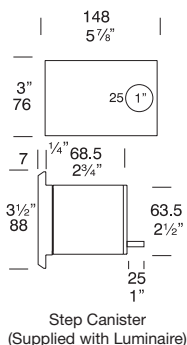

Accessories: Cable Joint Kit #CJK150, Frosted Lens #LENSSTEPF, Hex Cell Louvre Adaptor #HCL, Fluorescent Canister PVC #FLUCAN, IR Lamp #/IRC

HUNZA offers a comprehensive range of LED options and we regularly update the technology in line with the latest developments. Please refer to the Light Sources section of our website for the most up to date information on LED options for this luminaire.

Power Supply: HUNZA Buriable IG20 safety isolating transformer (single installation) or multi-installation with IG 40, IG100, or IG200 safety isolating transformers, HUNZA Wall Mount series WM100—WM300 Double Insulated Safety Isolating Transformers or H20 for internal installation only.

Standards: CE, EN60598, IP66/68 

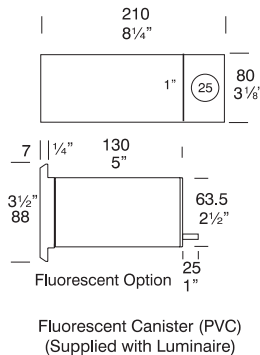

Driveway Lite

The Driveway Lite is mounted flush with the level of a driveway, pathway, hotel floors or building foyers – there is no lip to trip over. It can also be driven over or walked upon without damaging it.

The lamp can be directed up at a bush, tree, or the outside of a building, etc. without the need to remove the fitting from the canister, due to the vandal-resistant 3-Allen head screw fixing system which attaches the flange to the body of the luminaire.

The luminaire is supplied with a mounting canister that facilitates ease of installation.

This Driveway Lite has a solid bronze or 316 stainless steel flange with a powder coated black body.

The Driveway Lite has a 'Flush Fit' 10mm (⅜") thick tempered glass lens and silicon gasket which stops water pooling and depositing dirt on the lens. The lamp can be aimed up to 20 degrees without removing the fitting from the canister.

Suitable for use with a MR16 20, 35 or 50 watt lamp (20w max. in the USA) and is supplied with a high quality European 5000 hour lamp.

Lifetime Warranty on Lens Breakage.

Accessories: Cable Joint Kit #CJK150, Frosted Lens #LENSLLF, IR Lamp #/IRC

HUNZA offers a comprehensive range of LED options and we regularly update the technology in line with the latest developments. Please refer to the Light Sources section of our website for the most up to date information on LED options for this luminaire.

Power Supply: HUNZA Buriable IG20 or IG50 safety isolating transformer (single installation) or multi installation with IG40, IG100, IG150 or IG200 safety isolating transformers or HUNZA Wall Mount series WM100 – WM300 Double Insulated Safety Isolating Transformers.

Standards: IP66 

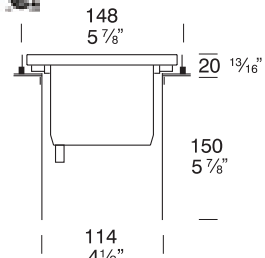



Cat. LL



Cat. LLDMV



Cat. IG111GM

Lawn Lite

The Lawn Lite is designed for insertion into a lawn or garden bed and can be mowed over without any damage being caused.

Designed so the lamp can be directed up at a bush, tree, or the outside of a building, etc. without the need to remove the fitting from the canister, due to the vandal-resistant 3-allen head screw fixing system which attaches the flange to the body of the luminaire.

This luminaire has either a solid bronze, 316 stainless steel, or a UV stable powder coated aluminium flange with a powder coated black body.

This luminaire has a 10mm (3/8") thick tempered 'Flush Fit' glass lens which stops water pooling and depositing dirt on the lens. Solidly constructed body cast from aluminium with UV stable powder-coat. The lamp can be aimed up to 20 degrees without removing the fitting from the canister.

Suitable for use with MR16 20, 35 or 50 watt lamp (20w max. in the USA) and is supplied with a high quality European 5000 hour lamp.

Lifetime Warranty on Lens Breakage.

Accessories: Cable Joint Kit #CJK150, Frosted Lens #LENSLLF, IR Lamp #/IRC

HUNZA offers a comprehensive range of LED options and we regularly update the technology in line with the latest developments. Please refer to the Light Sources section of our website for the most up to date information on LED options for this luminaire.

Power Supply: HUNZA Buriable IG20 or IG50 safety isolating transformer (single installation) or multi installation with IG40, IG100, IG150 or IG200 safety isolating transformers or HUNZA Wall Mount series WM100 – WM300 Double Insulated Safety Isolating Transformers

Standards: IP66

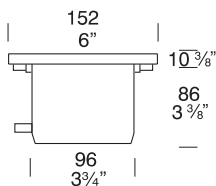

Lawn Lite Deck Mount

The Lawn Lite Deck Mount version is an uplighter for installation in timber decks.

Designed so the lamp can be directed up at a bush, tree, or the outside of a building, etc. without the need to remove the fitting from the canister, due to the vandal-resistant 3-allen head screw fixing system which attaches the flange to the body of the luminaire.

The fixture has a solid bronze or 316 stainless steel flange with a powder coated black body.

This luminaire has a 10mm (3/8") thick tempered 'Flush Fit' glass lens which stops water pooling and depositing dirt on the lens. The Lawn Lite Deck Mount version has a solidly constructed body cast from aluminium with UV stable powder coat. The lamp can be aimed up to 20 degrees without removing the fitting from the canister.

Suitable for use with a MR16 20, 35 or 50 watt lamp (20w max. in the USA) and is supplied with a high quality European 5000 hour lamp.

Note: Deck Lite is not suitable for driving over.

Lifetime Warranty on Lens Breakage.

Accessories: Cable Joint Kit #CJK150, Frosted Lens #LENSLLF, IR Lamp #/IRC

HUNZA offers a comprehensive range of LED options and we regularly update the technology in line with the latest developments. Please refer to the Light Sources section of our website for the most up to date information on LED options for this luminaire.

Power Supply: HUNZA Buriable IG20 or IG50 safety isolating transformer (single installation) or multi installation with IG40, IG100, IG150 or IG200 safety isolating transformers or HUNZA Wall Mount series WM100 – WM300 Double Insulated Safety Isolating Transformers.

Standards: IP66

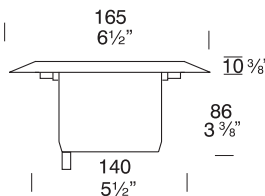

Inground 1-11gm

The Inground 1-11gm is a MR16 version of the IG1-11 uplighter that has a fully adjustable gimbal. This luminaire is suitable for use with MR16 lamps up to 75 watts and is supplied complete with a hex cell louvre and slot for mounting colour and linear spread lenses.

The Inground 1-11gm has an integral 120 or 240 volt ac transformer, which is dimmable. It is also available in a 12 volt version for use with a remote power supply.

The luminaire can be driven over at up to 10kph (6 mph) with a maximum vehicle weight of 1500kg (3000lbs). It can also be walked upon without causing damage. The luminaire is supplied with a 'Flush Fit' stepped lens which prevents water pooling and depositing dirt on the lens.

The Inground 1-11gm is supplied complete with a PVC mounting canister. The luminaire has a heavy duty cast aluminium body and a choice of 316 stainless steel or solid bronze flange.

The lamp can be directed up to 45 degrees from horizontal and rotated 360 degrees without the need to remove the fitting from the canister due to the vandal-resistant four allen-head screw fixing system which attaches the flange to the body of the luminaire.

Lifetime Warranty on Lens Breakage.

Accessories: Cable Joint Kit #CJK150, Frosted Lens #LENSAR111F, Protective Grille #IGGRILL, Linear Spread Lens #LENSSPREAD.

HUNZA offers a comprehensive range of LED options and we regularly update the technology in line with the latest developments. Please refer to the Light Sources section of our website for the most up to date information on LED options for this luminaire.

Power Supply: Integral 110/240 volt transformer.

Standards: IP66

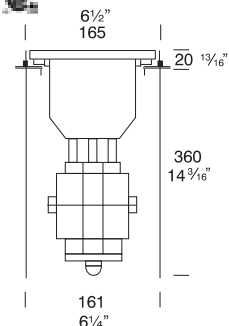



Cat. IG111



Cat. IG111MH

Inground 1-11

The Inground 1-11 is an inground up-lighter that sits flush with the level of the ground, driveway, pathway, hotel floors or building foyers, so there is no lip to trip over. The IG1-11 is ideal for lighting large trees, palms, columns and buildings etc.

The luminaire can be driven over (10kph or 6mph max) or walked upon without damaging it. The Luminaire has a 'flush fit' 10mm (3/8") thick glass lens which stops water pooling and depositing dirt on the lens.

Solidly constructed from a cast aluminium UV stable powder coated body, with heat dissipation fins to lower operating temperature. The fitting is available with either a solid bronze or 316 stainless steel flange.

The Inground 1-11 is suitable for use with 50w, 75W standard halogen and 60W IRC (equivalent to 100w) lamps, which have a range of beam angles from 4 to 45 degrees. It comes complete with its own 120/240 volt ac integral power supply and thermal overload, which is also dimmable. A 12 volt version for use with a remote transformer is also available.

Designed so the lamp can be directed (up to 20 degrees) without the need to remove the luminaire from the canister due to the vandal-resistant 4-allen head screw fixing system which attaches the flange to the body of the luminaire.

Lifetime Warranty on Lens Breakage.

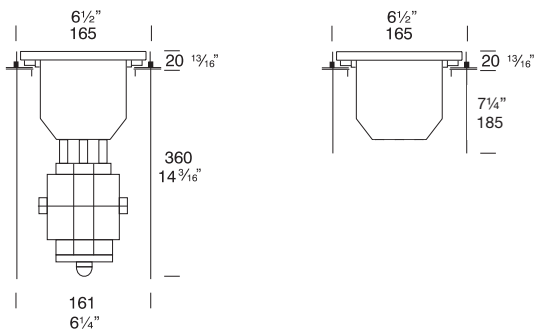

Accessories: Cable Joint Kit #CJK150, Frosted Lens #LENSAR111F, Protective Grille #IGGRILL

HUNZA offers a comprehensive range of LED options and we regularly update the technology in line with the latest developments. Please refer to the Light Sources section of our website for the most up to date information on LED options for this luminaire.

Power Supply: Integral 110/240 volt transformer

Standards: IP66 

Inground 1-11 Metal Halide

The Inground 1-11 Metal Halide uses a 20 or 35 watt MR16 Metal Halide lamp with an integral, electronic ballast. This luminaire is designed to be installed as a flush-mount recessed uplighter and is ideal for use in concrete or stone materials. It is supplied with a canister for easy mounting and provides 360 degree rotation and up to 35 degree elevation adjustment.

The Metal Halide lamp is extremely efficient, using considerably less energy and outputting 3-4 times the light of a halogen lamp. It also has a long 15,000 hour operational life, much higher than the average halogen lamp life.

Suitable for drive over, up to 10 km/h (6 mph), max. vehicle weight 1500kg (3300lb).

Accessories: Cable Joint Kit #CJK150, Frosted Lens #LENSAR111F, Linear Spread Lens #LENSSPREAD.

Power Supply: Ballast built in: 230/240 volt AC 50Hz

Ballast built in: 120 volt AC 60 Hz (USA/Canada).

Standards: AS/NZS 60598.2.2, IP66 

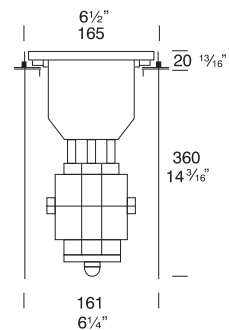



Cat. FFL



Cat. FFLSQ



Flush Floor Lite

The Flush Floor Lite has been designed to mount flush with the level of a pathway, hotel floor or a building foyer. The 'Flush Fit' lens stops water pooling and depositing dirt on the lens. There is no lip to trip over and the luminaire can be driven over or walked upon without being damaged.

There are no holes in the flange to ruin the aesthetics of the luminaire.

The luminaire is supplied with a mounting canister that facilitates ease of installation.

Lifetime Warranty on Lens Breakage.

Accessories: Cable Joint Kit #CJK150, Frosted Lens #LENSSTEPF, Hex Cell Louvre Adaptor #Cat. HCL, (Note: Supplied as standard for USA/Canada).

HUNZA offers a comprehensive range of LED options and we regularly update the technology in line with the latest developments. Please refer to the Light Sources section of our website for the most up to date information on LED options for this luminaire.

Power Supply: HUNZA Inground or Wall Mount Transformer: not included.

Standards: EN60598, IP68 

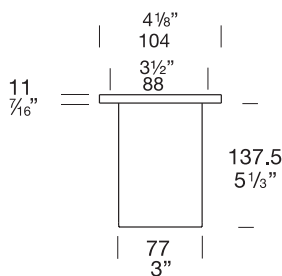

Flush Floor Lite Square

The Flush Floor Lite Square has been designed to mount flush with the level of a pathway, hotel floor or a building foyer. The 'Flush Fit' lens stops water pooling and depositing dirt on the lens. There is no lip to trip over and the luminaire can be driven over or walked upon without being damaged.

The square shape of The Flush Floor Lite Square makes it ideal for mounting in tiled areas. The Flush Floor Lite Square has a 110mm (4 1/4) diameter flange.

There are no holes in the flange to ruin the aesthetics of the luminaire.

Lifetime Warranty on Lens Breakage.

Accessories: Cable Joint Kit #CJK150, Frosted Lens #LENSSTEPF, Hex Cell Louvre Adaptor #Cat. HCL, (Note: Supplied as standard for USA/Canada).

HUNZA offers a comprehensive range of LED options and we regularly update the technology in line with the latest developments. Please refer to the Light Sources section of our website for the most up to date information on LED options for this luminaire.

Power Supply: HUNZA Inground or Wall Mount Transformer: not included.

Standards: EN60598, IP68 

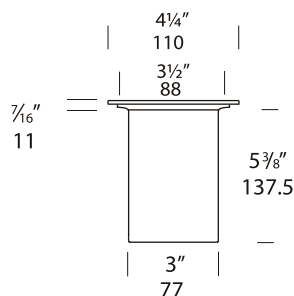



Cat. PL1



Cat. PL90



Cat. PL2



Cat. PL3



Cat. PL4

Path Lite

The Path Lite is ideal for lighting flat areas, decks, paved courtyards or edge lighting paths. This luminaire has a low profile (20mm or 3/4" high) and directs light horizontally through a frosted glass lens to reduce glare.

Available with a choice of either 1, 2, 3 or 4 facets depending on the light pattern required. The Path Lite 2-facet version may be used as a Step Lite in a wall or fence to shine light up and down.

Machined from a solid block of copper or 316 stainless steel with frosted tempered glass lens and high temperature silicon gaskets.

For use with a MR16 20 watt lamp and is supplied with a high quality European 5000 hour lamp.

A 110/240 volt fluorescent option is available, which offers excellent light output, low energy usage and very low heat generation. This option changes the luminaire to an IP66 rating. There is also the option of a long-life, low heat LED lamp, suitable for connection to a standard low voltage transformer.

A GU10 option can be specified with a 25 watt lamp – note the operating temperature does increase and this changes the luminaire to an IP66 rating.

Lifetime Warranty on Lens Breakage.

Accessories: Cable Joint Kit #CJK150, Deck Canister #DKCAN, Floor Lite Canister #FLCAN, or #CANSS (316 stainless), Fluorescent Option #FL, Fluorescent Canister PVC #FLUCAN, IR Lamp #/IRC

HUNZA offers a comprehensive range of LED options and we regularly update the technology in line with the latest developments. Please refer to the Light Sources section of our website for the most up to date information on LED options for this luminaire.

Power Supply: HUNZA Buriable IG20 safety isolating transformer (single installation), multi installation with IG40, IG100 or IG200 safety isolating transformers or HUNZA Wall Mount series WM100 - WM300 Double Insulated Safety Isolating Transformers.

Standards: IP66/68 

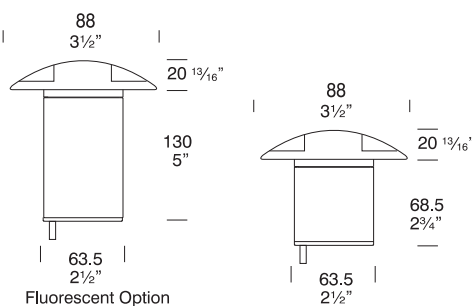



Cat. EPL



Cat. EPL1



Cat. EPL2



Cat. EPL3



Cat. EPL4

Euro Path Lite

The Euro Path Lite is designed for use with a MR11 lamp. This luminaire is ideal for lighting flat areas, decks, paved courtyards or edge lighting paths. The Euro Path Lite has a low profile and directs light horizontally through a frosted glass lens to reduce glare. Available with 1, 2, 3 or 4 facets for light to be projected through. The dirt guard has been developed to prevent dirt, mud and grass clippings from entering the optics area.

The Euro Path Lite 2 facet may be used as a Step Lite in a wall or fence, etc. to shine light up and down.

Machined from a solid block of copper or 316 stainless steel, frosted tempered glass lens and high temperature silicon gaskets.

Accessories: Cable Joint Kit #CJK150, Euro Floor Canister #Cat. Eflcan, Euro Deck Canister #Cat. Edkcan, Euro Lite Canister #Cat. Elcan, Euro Lite Canister 316 stainless steel #Cat. Elcanss, Euro Hex Cell Louvre #Cat. Ehcl.

HUNZA offers a comprehensive range of LED options and we regularly update the technology in line with the latest developments. Please refer to the Light Sources section of our website for the most up to date information on LED options for this luminaire.

Power Supply: HUNZA Inground or Wall Mount

Transformer: not included.

USA and Canada: HUNZA Wall Mount Transformer: not included.

Standards: IP66 

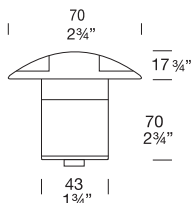

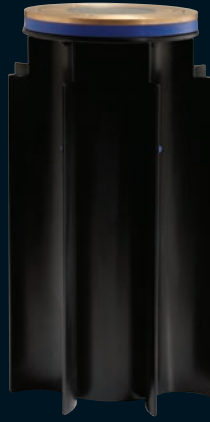

Cat. ST50

SafeTouch 50

The SafeTouch 50 inground uplighter is a more compact version of the ST150, designed and developed not only to produce optically pure light but also to achieve the lowest possible operating temperatures and energy consumption.

This luminaire is extremely tough, durable and waterproof, making it ideal for installation in public spaces and large-scale projects.

Public safety is the primary objective in the construction of the SafeTouch 50. A revolutionary, new mounting canister substantially increases heat transfer into the ground rather than the luminaire, allowing all exposed surfaces to operate at the coolest possible temperature. This canister provides solid and secure mounting for the luminaire as well as an effortless installation system for the contractor.

The ST50 was designed with energy conservation in mind. SafeTouch 50 metal halide luminaires feature the exclusive use of electronic ballasts to produce minimal heat with maximum energy efficiency and reliability. Electronic ballasts deliver 30% longer lamp life and have a significantly better 'end of life' control of the lamp compared with magnetic ballasts.

The SafeTouch 50 range offers many choices of light source, including metal halide and halogen.

Luminaire Construction

Body: Cast from virgin, high corrosion resistant, very low copper (0.01%) aluminium alloy, with an anti-corrosion layer, epoxy water-resistant layer and high a UV-resistant polyester powder coat top layer.
Colour: Black

Flange: The flange is attached to the body by three 316 stainless steel allen-head, vandal-resistant screws with anti-gall threaded inserts and is machined from either solid bronze or 316 stainless steel.
Flange Dimensions: 175mm x 6mm (6⁷/₈" x 1/4")

Mounting: The luminaire is supplied with a self-adjusting, heat-dissipating mounting canister designed to be cast in the ground or into concrete. Maximum drive over speed is 10 kph (6 mph) and maximum weight 2000 kg (4400 lb).

Lens: Multi-lens system for heat minimisation, using 12mm (1/2") flush-fit, extra clear, low-iron, tempered, shatter-resistant glass.

Gasket: Moulded silicon, high temperature 220°C (428°F)

Lamp Options:
GU5.3 20, 35 (USA 39), 45 watt IR Halogen Lamp. PGJ5 20 or 35 watt ceramic Metal Halide Lamp.

Maximum Lens Operating Temperatures

20 watt Metal Halide: 54.0°C (129.0°F)*
35 watt Metal Halide: 62.5°C (144.0°F)*
45 watt Halogen IRC: 65.0°C (149.0°F)*

*Luminaires are tested in 39°C dry sand for a period of 8 hours. Temperature reading is taken at the centre of the lens.

Reflector Angles:

2 x 5 degree (10 degree)
2 x 18 degree (36 degree)
2 x 30 degree (60 degree)

Lamp Adjustment:

20 degrees tilt with position lock
360 degrees rotation with position lock.

Power Supply:

Electronic Metal Halide Ballast, Potted
Input voltage: 220-240v AC 50Hz. COS 0.98.
Safety EN60926/EN60928/VDE 0712/1422
Harmonics EN61000-3-2
Immunity EN61547

Performance EN60927/EN60929
HUNZA Electronic Transformer (halogen)
Input voltage: 220-240v AC 50Hz COS 0.98
Safety EN61046

EMC EN55015

EN 61046

Z246

VO4156

USA and Canada:



Electronic Metal Halide Ballast
120v AC 50/60Hz
20w ANSI M175
39w ANSI M130

Accessories: Cable Joint Kit #CJK150, Frosted Lens #ST50FL, Hex Cell Louvre #ST50HCR, Anti-Slip Lens #ST50AS, Asymmetric Lens #ST50AL, Colour Filters - Blue, Red, Yellow, Green.

Standards: BS/EN 60598 2.2, IP67 (UL approvals due in 2010).

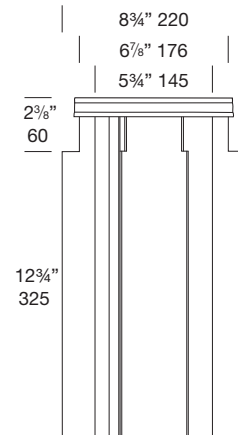



Cat. ST150



Safe Touch 150

The Safe Touch 150 in-ground uplighter has been designed and developed not only to produce optically pure light but also to achieve the lowest possible operating temperatures and energy consumption.

This luminaire is extremely tough, durable and waterproof, making it ideal for installation in public spaces and large-scale projects.

Public safety is the primary objective in the construction of the SafeTouch 150. A revolutionary, new mounting canister substantially increases heat transfer into the ground rather than the luminaire, allowing all exposed surfaces to operate at the coolest possible temperature. This canister provides solid and secure mounting for the luminaire as well as an effortless installation system for the contractor.

The ST150 was designed with energy conservation in mind. The SafeTouch 150 Metal Halide luminaires feature the exclusive use of electronic ballasts to produce minimal heat with maximum energy efficiency and reliability. Electronic ballasts deliver 30% longer lamp life and have a significantly better 'end of life' control of the lamp compared with magnetic ballasts.

The SafeTouch 150 range offers many choices of light source, including metal halide, mini white son (sodium) and halogen.

Luminaire Construction:

Body: Cast from virgin, high corrosion resistant, very low copper (0.01%) aluminium alloy, with an anti-corrosion layer, epoxy water-resistant layer and high UV-resistant polyester powder coat top layer. Anti-Syphon fitted. Colour: Black

Flange: The flange is attached to the body by five 316 stainless steel allen-head, vandal-resistant screws with anti-gall threaded inserts and is machined from either Solid Bronze or 316 stainless steel
 Flange Dimensions: 260mm x 6mm (10 1/4" x 1/4")
 Flange Finishes: Natural Bronze, High Polish or Machined Finish stainless steel.

Mounting: The luminaire is supplied with a self-adjusting, heat-dissipating mounting canister designed to be cast in the ground or into concrete. Maximum drive over speed is 10 kph (6 mph) and maximum weight 2000 kg (4400 lb).

Lens: Multi-lens system for heat minimisation, using 12mm (1/2") flush-fit, extra clear, low-iron, tempered, shatter-resistant glass.

Gasket: Moulded silicon, high temperature 220°C (428°F)

Lamp Options:

G12 35 (USA 39), 70, 150 watt (USA max. 100 watt)
 Ceramic Metal Halide lamp GX12.1 50 or 100 watt Mini White Son (Sodium) lamp (50 watt not available in USA and Canada) GX8.5 111 35, 70 watt Ceramic Metal Halide lamp GU53 30, 45, 60 watt IR Halogen Lamp

Maximum Lens Operating Temperatures

35 watt Metal Halide:	46.0°C (115.0°F)*
70 watt Metal Halide:	55.0°C (131.0°F)*
150 watt Metal Halide:	80.0°C (176.0°F) *
50 watt Mini White SON:	49.0 °c (120.0°F) *
100 watt Mini White SON:	65.0 °c (149.0°F) *

*Luminaires are tested in 39°C dry sand for a period of 8 hours. Temperature reading is taken at the centre of the lens.

Reflector Angles:

2 x 6 degree (12 degree)
 2 x 12 degree (24 degree)
 2 x 18 degree (36 degree)
 2 x 30 degree (60 degree)

Lamp Adjustment:

20 degrees tilt with position lock.
 360 degrees rotation with position lock.

Power Supply:

Electronic Ballasts Metal Halide and Mini White Son (Sodium)
 Input voltage: 220-240v AC 50Hz COS 0.98
 Safety EN61347-2-1/3-4/2-9
 Performance EN60927/EN60929
 RFI EN55015/EN55022
 Harmonic EN 61547
 EMC EN 61547
 HUNZA Halogen Electronic Transformer
 Input Voltage: 220-240v AC 50Hz COS 0.98
 Safety EN61046
 EMC EN55015
 VO4156

USA and Canada:



Metal Halide Electronic Ballast: 120-277V AC 50/60Hz
 39w ANSI M130,
 70w ANSI M98, M143, M139, 150w ANSI M164, M142
 Mini White SON Electronic Ballast: 120-277V AC 50/60Hz
 100w ANSI S167

Accessories:

Cable Joint Kit #CJK150, Frosted Lens #ST150FL, Hex Cell Louvre #ST150HCR, Anti-Slip Lens #ST150AS, Asymmetric Lens #ST150AL, Colour Filters - Blue, Red, Yellow, Green.

Standards: BS/EN 60598 2.2, IP67 (UL approvals due in 2010)

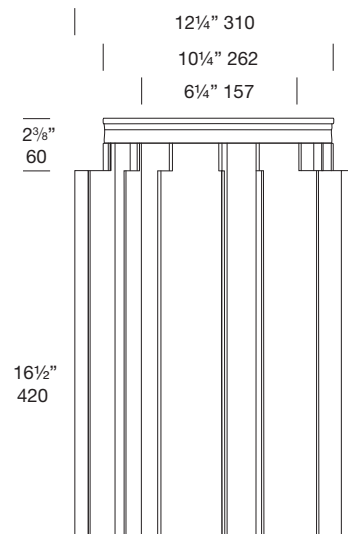

Step

HUNZA step lights blend unobtrusively into steps and wall surfaces and are used for a variety of illumination techniques such as step lighting, path lighting and driveway lighting. Many of these durable, recessed luminaires use a mounting canister to simplify installation – these accessories need to be specified separately.





Cat. ESL



Cat. ESLS

Euro Step Lite

The Euro Step Lite is an extra-compact luminaire designed for step lighting applications where the fixture needs to be very unobtrusive or concealed.

HUNZA Euro fixtures use a miniature MR11 lamp to achieve the compact dimensions but are still able to provide excellent illumination.

The Euro Step Lite is designed for recessed mounting into masonry, stone or wood and when the appropriate HUNZA mounting canister is specified there are no visible mounting screws (canisters must be specified when ordering).

Designed with a 69mm (2³/₄)" flange, body machined from 45mm (1³/₄)" thick solid copper or 316 stainless steel, clear tempered glass lenses with high temperature silicon gaskets.

Suitable for use with a MR11– 5, 10 or 20 watt lamp (10 watt max. in the USA).

Lifetime Warranty on Lens Breakage.

Accessories: Cable Joint Kit #CJK150, Frosted Lens #LENSEURF, Euro Step Lite Canister #ELCAN (aluminium), #ECANSS (316 stainless), Euro Deck Mount Canister #ELDKCAN (for wood).

HUNZA offers a comprehensive range of LED options and we regularly update the technology in line with the latest developments. Please refer to the Light Sources section of our website for the most up to date information on LED options for this luminaire.

Power Supply: HUNZA Buriable IG20 safety isolating transformer (single installation), or multi installation with IG40, IG100 or IG200 safety isolating transformers or HUNZA Wall Mount series WM100 – WM300 Double Insulated Safety Isolating Transformers.

Standards: IP66 

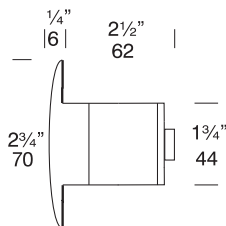

Euro Step Lite Solid Eyelid

The Euro Step Lite Solid Eyelid is an extra compact luminaire designed for step lighting applications where the fixture needs to be very unobtrusive or concealed. The eyelid masks two thirds of the lamp, which eliminates all upward light.

HUNZA Euro fixtures use a miniature MR11 lamp to achieve the compact dimensions but are still able to provide excellent illumination.

The Euro Step Lite is designed for recessed mounting into masonry, stone or wood and when the appropriate HUNZA mounting canister is specified there are no visible mounting screws (canisters must be specified when ordering).

Designed with a 69mm (2³/₄)" flange, a body machined from 45mm (1³/₄)" thick solid copper or 316 stainless steel and a clear tempered glass lens with high temperature silicon gaskets.

Suitable for use with a MR11– 5, 10 or 20 watt lamp (10 watt max. in the USA).

Lifetime Warranty on Lens Breakage.

Accessories: Cable Joint Kit #CJK150, Frosted Lens #LENSEURF, Euro Step Lite Canister #ELCAN (aluminium), #ECANSS (316 stainless), Euro Deck Mount Canister #ELDKCAN (for wood).

HUNZA offers a comprehensive range of LED options and we regularly update the technology in line with the latest developments. Please refer to the Light Sources section of our website for the most up to date information on LED options for this luminaire.

Power Supply: HUNZA Buriable IG20 safety isolating transformer (single installation), or multi installation with IG40, IG100 or IG200 safety isolating transformers or HUNZA Wall Mount series WM100 – WM300 Double Insulated Safety Isolating Transformers.

Standards: IP66 

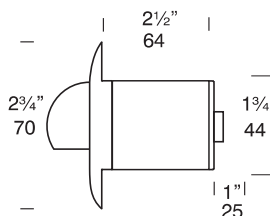



Cat. SL



Cat. SLSQ

Step Lite

The Step Lite is designed with a 88mm (2½") flange and recessed body for flush mounting into masonry, stone or wood, providing illumination of steps and low level features, for example, across driveways or exterior paved areas.

When a HUNZA mounting canister is used there are no mounting holes in the flange (this option must be specified when ordering).

The luminaire is machined from a choice of 10mm (¾") thick aluminium with a UV stable powder coated finish (10 standard colours), solid copper or 316 stainless steel with a clear, tempered, stepped glass lens and high temperature silicon gaskets.

The Step Lite is suitable for use with a MR16 20 watt lamp and is supplied with a high quality European 5000 hour lamp.

A 110/240 volt fluorescent option is available, which offers excellent light output, low energy usage and very low heat generation. This option changes the luminaire to an IP66 rating.

A GU10 option can be specified with a 25 watt lamp – note that the operating temperature does increase and this changes the luminaire to an IP66 rating.

Lifetime Warranty on Lens Breakage.

Accessories: Cable Joint Kit #CJK150, Frosted Lens #LENSSTEFF, Hex Cell Louvre Adaptor #HCL, Fluorescent Option #FL, Step Lite Canister #SLCAN, 316 stainless steel #CANSS, Deck Mount Canister #DKCAN (for wood), Internal Stud Canister #SLCAN/INTSTUD, Fluorescent Canister PVC #FLUCAN, IR Lamp #/IRC

HUNZA offers a comprehensive range of LED options and we regularly update the technology in line with the latest developments. Please refer to the Light Sources section of our website for the most up to date information on LED options for this luminaire.

Power Supply: HUNZA Buriable IG20 safety isolating transformer (single installation), or multi installation with IG40, IG100, IG150 or IG200 safety isolating transformers or HUNZA Wall Mount series WM100 – WM300 Double Insulated Safety Isolating Transformers.

Standards: CE, EN60598, IP66/68 

Step Lite Square

The Step Lite Square is designed with a 88mm (3½") flange and recessed body for flush mounting into masonry, stone or wood, providing illumination of steps and low level features, for example across driveways or exterior paved areas.

When a HUNZA mounting canister is used there are no mounting holes in the flange (canisters must be specified when ordering).

The luminaire is machined from a choice of 10mm (¾") thick aluminium with a UV stable powder coated finish (10 standard colours), solid copper or 316 stainless steel with a clear, tempered, stepped glass lens and high temperature silicon gaskets.

This Luminaire is suitable for use with a MR16 20 watt lamp and is supplied with a high quality European 5000 hour lamp.

A 110/240 volt fluorescent option is available, which offers excellent light output, low energy usage and very low heat generation. This option changes the luminaire to an IP66 rating.

A GU10 option can be specified with a 25 watt lamp – note that operating temperature does increase and this changes the luminaire to an IP66 rating.

Lifetime Warranty on Lens Breakage.

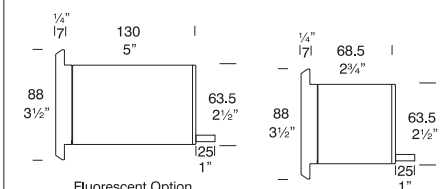
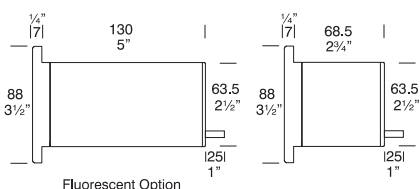



Cat. SLE

Accessories: Cable Joint Kit #CJK150, Frosted Lens #LENSSTEPF, Hex Cell Louvre Adaptor #HCL, Fluorescent Option #FL, Step Lite Canister #SLCAN, 316 stainless steel #CANSS, Deck Mount Canister #DKCAN (for wood), Internal Stud Canister #SLCAN/INTSTUD, Fluorescent Canister PVC #FLUCAN, IR Lamp #/IRC

HUNZA offers a comprehensive range of LED options and we regularly update the technology in line with the latest developments. Please refer to the Light Sources section of our website for the most up to date information on LED options for this luminaire.

Power Supply: HUNZA Buriable IG20 safety isolating transformer (single installation), or multi installation with IG40, IG100, IG150 or IG200 safety isolating transformers or HUNZA Wall Mount series WM100 – WM300 Double Insulated Safety Isolating Transformers.

Standards: CE, EN60598, IP66/68 

Step Lite Eyelid

The Step Lite Eyelid is designed with a 88mm (3½") flange and recessed body for flush mounting into masonry, stone or wood, providing illumination of steps and low level features, for example exterior paved areas. The eyelid feature eliminates all upward light, providing an excellent glare-free illuminating effect.

When a HUNZA mounting canister is used there are no mounting holes in the flange (canisters must be specified when ordering).

The luminaire is machined from a choice of 10mm (⅜") thick aluminium with a UV stable powder coated finish (10 standard colours), solid copper or 316 stainless steel with a clear, tempered, stepped glass lens and high temperature silicon gaskets.

Suitable for use with a MR16 20 watt lamp and is supplied with a high quality European 5000 hour lamp.

A 110/240 volt fluorescent option is available, which offers excellent light output, low energy usage and very low heat generation. This option changes the luminaire to an IP66 rating.

A GU10 option can be specified with a 25 watt lamp—note that operating temperature does increase and this changes the luminaire to an IP66 rating.

Lifetime Warranty on Lens Breakage.

Accessories: Cable Joint Kit #CJK150, Frosted Lens #LENSSTEPF, Hex Cell Louvre Adaptor #HCL, Fluorescent Option #FL, Step Lite Canister #SLCAN, 316 stainless steel #CANSS, Deck Mount Canister #DKCAN (for wood), Internal Stud Canister #SLCAN/INTSTU), Fluorescent Canister PVC #FLUCAN, IR Lamp #/IRC

Power Supply: HUNZA Buriable IG20 safety isolating transformer (single installation), or multi installation with IG40, IG100, IG150 or IG200 safety isolating transformers or HUNZA Wall Mount series WM100 – WM300 Double Insulated Safety Isolating Transformers.

HUNZA offers a comprehensive range of LED options and we regularly update the technology in line with the latest developments. Please refer to the Light Sources section of our website for the most up to date information on LED options for this luminaire.

Standards: CE, EN60598, IP66/68 

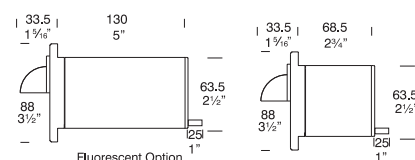



Cat. SLLU



Cat. SLLUSQ

Step Lite Louvre

The Step Lite Louvre is designed with a 88mm (3½") low-profile flange and recessed body for flush mounting into masonry, stone or wood, providing illumination of steps and low level features, for example exterior paved areas. The 45 degree louvre eliminates all upward light, providing an excellent glare-free illuminating effect.

When a HUNZA mounting canister is used there are no mounting holes in the flange (canisters must be specified when ordering).

The luminaire is machined from a choice of solid copper or 316 stainless steel with a clear, tempered, glass lens and high temperature silicon gaskets.

The Step Lite Louvre is suitable for use with a MR16 20 watt lamp and is supplied with a high quality European 5000 hour lamp.

A 110/240 volt fluorescent option is available, which offers excellent light output, low energy usage and very low heat generation. This option changes the luminaire to an IP66 rating.

A GU10 option can be specified with a 25 watt lamp – note that the operating temperature does increase and this changes the luminaire to an IP66 rating.

Lifetime Warranty on Lens Breakage.

Accessories: Cable Joint Kit #CJK150, Frosted Lens #LENSSTEFF, Hex Cell Louvre Adaptor #HCL, Fluorescent Option #FL, Step Lite Canister #SLCAN, 316 stainless steel #CANSS, Deck Mount Canister #DKCAN (for wood), Internal Stud Canister #SLCAN/INTSTUD, Fluorescent Canister PVC #FLUCAN, IR Lamp #/IRC

HUNZA offers a comprehensive range of LED options and we regularly update the technology in line with the latest developments. Please refer to the Light Sources section of our website for the most up to date information on LED options for this luminaire.

Power Supply: HUNZA Buriable IG20 safety isolating transformer (single installation), or multi installation with IG40, IG100, IG150 or IG200 safety isolating transformers or HUNZA Wall Mount series WM100 – WM300 Double Insulated Safety Isolating Transformers.

Standards: CE, EN60598, IP66/68 

Step Lite Louvre Square

The Step Lite Louvre Square is designed with a 88mm (3½") low-profile flange and recessed body for flush mounting into masonry, stone or wood, providing illumination of steps and low level features, for exterior paved areas. The 45 degree louvre eliminates all upward light, providing an excellent glare-free illuminating effect.

When a HUNZA mounting canister is used there are no mounting holes in the flange (canisters must be specified when ordering).

The luminaire is machined from a choice of solid copper or 316 stainless steel with a clear, tempered, stepped glass lens and high temperature silicon gaskets.

The Step Lite Louvre Square is suitable for use with a MR16 20 watt lamp and is supplied with a high quality European 5000 hour lamp.

A 110/240 volt fluorescent option is available, which offers excellent light output, low energy usage and very low heat generation. This option changes the luminaire to an IP66 rating.

A GU10 option can be specified with a 25 watt lamp – note that operating temperature does increase and this changes the luminaire to an IP66 rating.

Lifetime Warranty on Lens Breakage

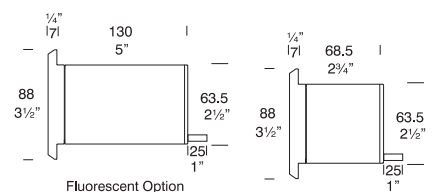
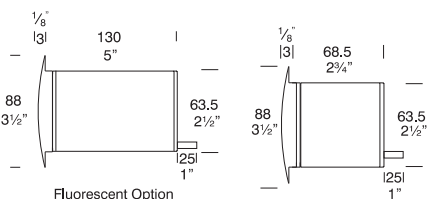



Cat. SLSQ/SQ

Accessories: Cable Joint Kit #CJK150 , Fluorescent Option 8 watt 240 volt #Cat. FL IP66, Fluorescent Canister, PVC #Cat. FLUCAN, Frosted Lens #Cat. LENSSTEPF, Step Canister #Cat. SLCAN, 316 Stainless Canister for use in lime stone etc. #Cat. CANSS

HUNZA offers a comprehensive range of LED options and we regularly update the technology in line with the latest developments. Please refer to the Light Sources section of our website for the most up to date information on LED options for this luminaire.

Power Supply: HUNZA Inground or Wall Mount, Transformer: not included., USA and Canada: HUNZA Wall Mount Transformer: not included, Luminaire: supplied with Halogen MR16 GU5.3 20 watt lamp max Fluorescent E27 - 110/240 volt self ballasted lamp. USA and Canada: MR16 GU5.3 20 watt lamp max.

Standards: EN60598, IP66/IP68 

Step Lite Square on Square

The Step Lite Square on Square has a second square, frosted, glass lens recessed into the flange to provide a more contemporary look for modern installations.

This luminaire comes with a high quality European 5000 hour, 20 watt MR16 lamp to avoid undue heat build-up at the lens surface.

The Step Lite Square on Square requires a HUNZA Canister to be specified separately. The fixture is held into the mounting canister by two 'O' rings, which allow easy removal for lamp replacement, hence there are no mounting screws in the flange to spoil the aesthetics of the luminaire.

The fixture body is machined from 9mm ($\frac{11}{32}$) thick 316 stainless steel and has a tempered, stepped glass lens with high temperature silicon gaskets. The Step Lite Square on Square is also available in solid copper.

A 110/240 volt fluorescent option is available, which offers excellent light output, low energy usage and very low heat generation. This option changes the luminaire to an IP66 rating.

A GU10 option can be specified with a 25 watt lamp – note that operating temperature does increase and this changes the luminaire to an IP66 rating.

Accessories: Cable Joint Kit #CJK150 , Deck Canister #Cat. DKCAN, Frosted Lens #Cat. LENSSTEPF, Floor Canister #Cat. FLCAN, Fluorescent Canister PVC #Cat. FLUCAN, Fluorescent Option 8 watt 240 volt #Cat. FL, Hex Cell Louvre Adaptor #Cat. HCL (Note: Supplied as standard for USA/Canada), 316 Stainless Canister for use in lime stone etc. #Cat. CANSS

HUNZA offers a comprehensive range of LED options and we regularly update the technology in line with the latest developments. Please refer to the Light Sources section of our website for the most up to date information on LED options for this luminaire.

Power Supply: HUNZA Inground or Wall Mount, Transformer: not included. USA and Canada: HUNZA Wall Mount Transformer: not included, Luminaire supplied with MR16 GU5.3 - 20 watt lamp max, Fluorescent E27 - 110 / 240 volt self ballasted lamp, USA and Canada: MR16 GU5.3 20 watt lamp max.

Standards: EN60598, IP66/IP68 

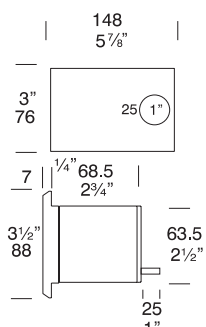

Step Canister
(Supplied with Luminaire)

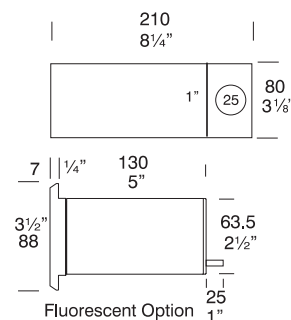

Fluorescent Canister (PVC)
(Supplied with Luminaire)



Cat. SLSSQ

Step Lite Solid Eyelid Square

The Step Lite Solid Eyelid Square is designed with a 88mm (3½") flange and recessed body for flush mounting into masonry, stone or wood, providing illumination of steps and low level features such as exterior paved areas. The eyelid feature eliminates all upward light, providing an excellent glare-free illuminating effect.

When a HUNZA mounting canister is used there are no mounting holes in the flange (canisters must be specified when ordering).

The luminaire is machined from a choice of 10mm (¾") thick aluminium with a UV stable powder coated finish (10 standard colours), solid copper or 316 stainless steel with a clear, tempered, stepped glass lens and high temperature silicon gaskets.

The Step Lite Solid Eyelid Square is suitable for use with a MR16 20 watt lamp and is supplied with a high quality European 5000 hour lamp.

A 110/240 volt fluorescent option is available, which offers excellent light output, low energy usage and very low heat generation. This option changes the luminaire to an IP66 rating.

A GU10 option can be specified with a 25 watt lamp – note that operating temperature does increase and this changes the luminaire to an IP66 rating.

Lifetime Warranty on Lens Breakage.

Accessories: Cable Joint Kit #CJK150, Frosted Lens #LENSSTEFF, Hex Cell Louvre Adaptor #HCL, Fluorescent Option #FL, Step Lite Canister #SLCAN, 316 stainless steel #CANSS, Deck Mount Canister #DKCAN (for wood), Internal Stud Canister #SLCAN/INTSTUD, Fluorescent Canister PVC #FLUCAN, IR Lamp #/IRC

HUNZA offers a comprehensive range of LED options and we regularly update the technology in line with the latest developments. Please refer to the Light Sources section of our website for the most up to date information on LED options for this luminaire.

Power Supply: HUNZA Buriable IG20 safety isolating transformer (single installation), or multi installation with IG40, IG100, IG150 or IG200 safety isolating transformers or HUNZA Wall Mount series WM100 – WM300 Double Insulated Safety Isolating Transformers.

Standards: CE, EN60598, IP66/68



Cat. SLS

Step Lite Solid Eyelid

The Step Lite Solid Eyelid is designed with a 88mm (3½") flange and recessed body for flush mounting into masonry, stone or wood, providing illumination of steps and low level features such as exterior paved areas. The eyelid feature eliminates all upward light, providing an excellent glare-free illuminating effect.

When a HUNZA mounting canister is used there are no mounting holes in the flange (canisters must be specified when ordering).

The luminaire is machined from a choice of 10mm (¾") thick aluminium with a UV stable powder coated finish (10 standard colours), solid copper or 316 stainless steel with a clear, tempered, stepped glass lens and high temperature silicon gaskets.

The Step Lite Solid Eyelid Square is suitable for use with a MR16 20 watt lamp and is supplied with a high quality European 5000 hour lamp.

A 110/240 volt fluorescent option is available, which offers excellent light output, low energy usage and very low heat generation. This option changes the luminaire to an IP66 rating.

A GU10 option can be specified with a 25 watt lamp – note that operating temperature does increase and this changes the luminaire to an IP66 rating.

Lifetime Warranty on Lens Breakage.

Standards: CE, EN60598, IP66/68

For Accessories and Power supply specifications please refer to Step Lite Solid Eyelid Square.

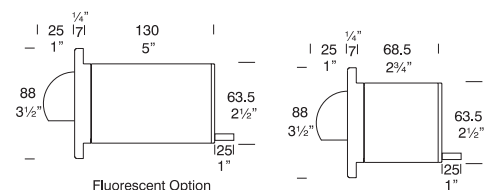
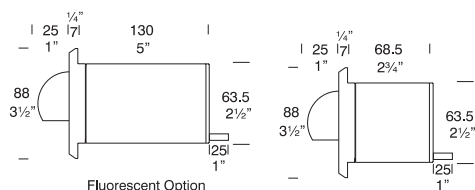

HUNZA outdoor wall lights are designed for mounting to the side of buildings or vertical surfaces in order to highlight the wall structure and texture or provide an elevated position for illumination of specific features or areas. These durable, wall mounted lights can be supplied either for connection to a remote transformer or with an integral 120/240 volt Retro Wall transformer for situations where the use of a remote transformer is not practical.

Wall Mount





Cat. BLWS and BLWS/R



Cat. EWS and EWS/R



Cat. WS and WS/R

Border Lite Wall Spot

The Border Lite Wall Spot is a wall-mounted luminaire with a fully adjustable head allowing for 360 degree rotation and 0–90 degree elevation. This makes the luminaire ideal for wash-lighting on pillars, columns or walls.

The luminaire is cast from virgin high corrosion-resistant low copper aluminium with a UV stable powder coated finish, solid bronze or 316 stainless steel with a clear, tempered flush glass lens and high temperature silicon gasket.

The Retro is a 110/240-12 ac mains option suited to installation where mounting a transformer is a problem, e.g. a brick wall where there is only a cable protruding out of the wall and it is not an option to recess the transformer. The base increases in size to accommodate the encapsulated dimmable transformer.

Lifetime Warranty on Lens Breakage.

Accessories: Clear Lens #Cat. LENSBLC, Retro™ transformer 110/240-12 volt #Cat. /R

HUNZA offers a comprehensive range of LED options and we regularly update the technology in line with the latest developments. Please refer to the Light Sources section of our website for the most up to date information on LED options for this luminaire.

Power Supply: HUNZA Wall Mount Transformer, not included.

Standards: IP66

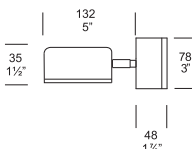
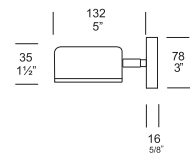

Euro Wall Spot

The Euro Wall Spot is a wall-mounted luminaire with a fully adjustable head allowing 360 degree rotation and 0–90 degree elevation.

HUNZA Euro fixtures use a miniature MR11 lamp to achieve a contemporary, discreet appearance but are still able to provide excellent illumination.

Machined from 45mm (1 3/4") solid copper or 316 stainless steel, with a clear, tempered, glass lens, high temperature silicon gaskets and integral hex cell louvre.

The Euro Wall Spot has a 60mm (3" in the USA) diameter mounting base.

Available in 12 volt or with a built-in 110 or 240 volt Retro transformer. The Retro is a 110/240 volt option suited to an installation where mounting a transformer is a problem or when replacing an existing fixture. The base depth increases to 48mm (1 7/8") to accommodate the encapsulated IP66 dimmable transformer.

All USA Retro wall mount fixtures are supplied with a wide backplate designed to suit a standard 3/0 or 4/0 junction box (this plate must be ordered separately for non-Retro fixtures – /WBAP).

Suitable for use with MR11 5, 10 or 20 watt lamp (10W max. in the USA).

Lifetime Warranty on Lens Breakage.

Accessories: Cable Joint Kit #CJK150, Wall Box Adaptor Plate #WBAP, Frosted Glass Lens #LENSEURF.

HUNZA offers a comprehensive range of LED options and we regularly update the technology in line with the latest developments. Please refer to the Light Sources section of our website for the most up to date information on LED options for this luminaire.

Power Supply: HUNZA Wall Mount series WM100 – WM300 Double Insulated Safety Isolating Transformers. For internal mounting use HUNZA H20 or H50 internal transformers. Retro Option #/R – Integral 120/240 Volt 75 watt Electronic Transformer.

Standards: AS/NZ61046, IP66

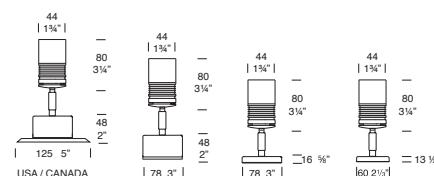

Wall Spot

The Wall Spot is a wall-mounted luminaire with a fully adjustable head allowing 360 degree rotation and 0–90 degree elevation.

The luminaire is machined from a choice of 10mm (3/8") thick aluminium with a UV stable powder coated finish (10 standard colours), solid copper or 316 stainless steel with a clear, tempered, stepped glass lens and high temperature silicon gaskets.

Available in 12 volt or with a built-in 110 or 240 volt Retro transformer. The Retro is a 110/240 volt option suited to an installation where mounting a transformer is a problem or when replacing an existing fixture. The base depth increases to 48mm (1 7/8") to accommodate the encapsulated IP66 dimmable transformer.

All USA Retro wall mount fixtures are supplied with a wide backplate designed to suit a standard 3/0 or 4/0 junction box (this plate must be ordered separately for non-Retro fixtures – /WBAP).

Suitable for use with MR16 – 20, 35 or 50 watt lamps (35w max. in the USA) and is supplied with a high quality European 5000-hour lamp.

Lifetime Warranty on Lens Breakage

Accessories: Cable Joint Kit #CJK150, Wall Box Adaptor Plate #WBAP, Frosted Glass Lens #LENSTEPF, Glare Guard #GG, Hex Cell Louvre Adaptor #HCL, IR Lamp #IRC.

HUNZA offers a comprehensive range of LED options and we regularly update the technology in line with the latest developments. Please refer to the Light Sources section of our website for the most up to date information on LED options for this luminaire.

Power Supply: HUNZA Wall Mount series WM100 – WM300 Double Insulated Safety Isolating Transformers. For internal mounting use HUNZA H20 or H50 internal transformers. Retro Option #/R – Integral 120/240 Volt 75 watt Electronic Transformer.

Standards: CE, EN60598, AS/NZ61046, IP66

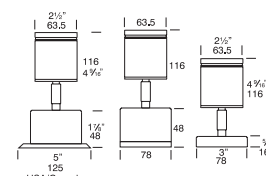



Cat. WS/MH

Wall Spot Metal Halide

The Wall Spot Metal Halide uses a 20 or 35 watt MR16 Metal Halide lamp with an integral, electronic ballast. This luminaire has been designed to be easily mounted on a wall and provide directional light for pathways and structural elements of a building.

The Wall Spot Metal Halide has a fully adjustable head allowing 360 degree rotation and 0–90 degree elevation adjustment.

The Metal Halide lamp is extremely efficient, using considerably less energy and outputting 3–4 times the light of a halogen lamp. It also has a long 12,000 hour operational life, much higher than the average halogen lamp life.

Highly durable construction, machined components, hand assembled solid copper, 316 stainless steel or powder coated aluminium (10 standard colours).

Lifetime Warranty on Lens Breakage.

Accessories: Frosted Lens #LENSSTEPF, Glare Guard #/GG

Power Supply: Ballast built in: 230/240 volt AC 50Hz

Ballast built in: 120 volt AC 60 Hz (USA/Canada)

Standards: AS/NZS 60598.2.2, IP66 

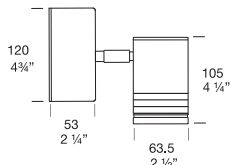

Cat. PIL and PIL/R

Pillar Lite

The Pillar Lite illuminates both upwards and downwards, giving columns, gateway pillars and entrances a dramatic effect.

The luminaire is machined from a choice of 10mm (3/8") thick aluminium with a UV stable powder coated finish (10 standard colours), solid copper or 316 stainless steel with a clear, tempered, stepped glass lens and high temperature silicon gaskets.

Available in 12 volt or with a built-in 110 or 240 volt Retro transformer. The Retro is a 110/240 volt option suited to an installation where mounting a transformer is a problem or when replacing an existing fixture. The base depth increases to 48mm (1 7/8") to accommodate the encapsulated IP66 dimmable transformer.

All USA Retro wall-mount fixtures are supplied with a wide backplate designed to suit a standard 3/0 or 4/0 junction box (this plate must be ordered separately for non-Retro fixtures – /WBAP).

Suitable for use with MR16 2 x 20 watt lamps and is supplied with high quality European 5000-hour lamps.

Lifetime Warranty on Lens Breakage.

Accessories: Cable Joint Kit #CJK150, Wall Box Adaptor Plate #/WBAP, Frosted Glass Lens #LENSSTEPF, Glare Guard #GG, Hex Cell Louvre Adaptor #HCL, IR Lamp #/IRC.

HUNZA offers a comprehensive range of LED options and we regularly update the technology in line with the latest developments. Please refer to the Light Sources section of our website for the most up to date information on LED options for this luminaire.

Power Supply: HUNZA Wall Mount series WM100 – WM300 Double Insulated Safety Isolating Transformers. For internal mounting use HUNZA H20 or H50 internal transformers. Retro Option #/R – Integral 120/240 Volt 75 watt Electronic Transformer.

Standards: AS/NZ61046, IP66 

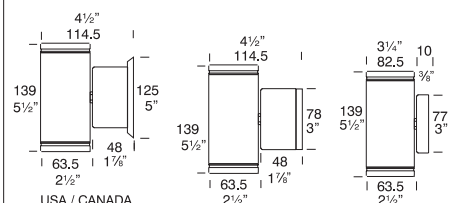



Cat. EPIL and EPIL/R

Euro Pillar

The Euro Pillar is a wall-mounted luminaire with both up and down illumination to provide a dramatic, wash-lighting effect on tall walls and columns.

Euro fixtures use a miniature MR11 lamp to achieve a contemporary, discreet appearance but are still able to provide excellent illumination. Machined from 45mm (1 3/4") solid copper or 316 stainless steel, with a clear, tempered, glass lens, high temperature silicon gaskets and integral hex cell louvre.

Available in 12 volt or with a built-in 110 or 240 volt Retro transformer. The Retro is a 110/240 volt option suited to an installation where mounting a transformer is a problem or when replacing an existing fixture. The base depth increases to 48mm (1 7/8") to accommodate the encapsulated IP66 dimmable transformer.

All USA Retro wall mount fixtures are supplied with a wide backplate designed to suit a standard 3/0 or 4/0 junction box (this plate must be ordered separately for non-Retro fixtures – /WBAP).

Suitable for use with MR11 – 2 x 5, 10 or 20 watt lamp (10W max. in the USA).

Lifetime Warranty on Lens Breakage.

Accessories: Cable Joint Kit #CJK150, Wall Box Adaptor Plate #WBAP, Frosted Glass Lens #LENSEURF.

HUNZA offers a comprehensive range of LED options and we regularly update the technology in line with the latest developments. Please refer to the Light Sources section of our website for the most up to date information on LED options for this luminaire.

Power Supply: HUNZA Wall Mount series WM100 – WM300 Double Insulated Safety Isolating Transformers. For internal mounting use HUNZA H20 or H50 internal transformers. Retro Option #/R – Integral 120/240 Volt 75 watt Electronic Transformer.

Standards: AS/NZ61046, IP66

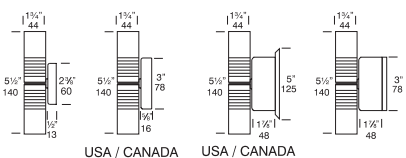

Cat. PGL and PGL/R

Pagoda Lite

The Pagoda Lite is a wall-mounted luminaire that provides non-directional lighting and is ideal for illumination of areas such as porches or entrance ways.

The lens is manufactured from high UV stable polycarbonate with stainless anti-glare mesh.

The luminaire is machined from a choice of 10mm (3/8") thick aluminium with a UV stable powder coated finish (10 standard colours), solid copper or 316 stainless steel and high temperature silicon gaskets.

Available in 12 volt or with a built-in 110 or 240 volt Retro transformer. The Retro is a 110/240 volt option suited to an installation where mounting a transformer is a problem or when replacing an existing fixture. The base depth increases to 48mm (1 7/8") to accommodate the encapsulated IP66 dimmable transformer.

All USA Retro wall mount fixtures are supplied with a wide backplate designed to suit a standard 3/0 or 4/0 junction box (this plate must be ordered separately for non-Retro fixtures—/WBAP).

Suitable for use with G4 bi-pin 5, 10 or 20 watt lamps and is supplied with a high quality European lamp.

Accessories: Cable Joint Kit #CJK150, Wall Box Adaptor Plate #WBAP, Frosted Lens #LENSBOLF.

HUNZA offers a comprehensive range of LED options and we regularly update the technology in line with the latest developments. Please refer to the Light Sources section of our website for the most up to date information on LED options for this luminaire.

Power Supply: HUNZA Wall Mount series WM100 – WM300 Double Insulated Safety Isolating Transformers. For internal mounting use HUNZA H20 or H50 internal transformers. Retro Option #/R – Integral 120/240 Volt 75 watt Electronic Transformer.

Standards: AS/NZ61046, IP66

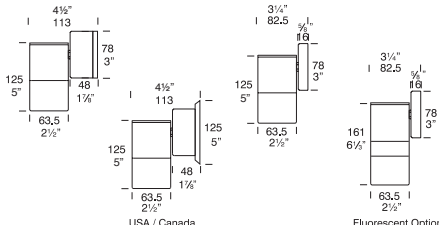

Cat. PILPGL and PILPGL/R

Pillar Pagoda Lite

The Pillar Pagoda Lite has a G4 and a MR16 lamp. The G4 lamp can be used to produce a general lighting effect, while the MR16 may be used for uplighting or downlighting.

The luminaire is machined from a choice of 10mm (3/8") thick aluminium with a UV stable powder coated finish (10 standard colours), solid copper or 316 stainless steel with a clear, tempered, stepped glass lens and high temperature silicon gaskets.

The Retro is a 110/240-12 ac mains option suited to an installation where mounting a transformer is a problem, e.g. a brick wall where there is only the cable protruding out of the wall and it is not an option to recess the transformer or when replacing an existing light fitting. The base size increases in size to accommodate the encapsulated IP66 dimmable transformer.

Accessories: Cable Joint Kit #CJK150, Retro Transformer 110/240-12 volt #Cat. /R, Wall Box Adaptor Plate USA / Canada #Cat. WBAP 12 volt luminaire, Opaque Lens Cat. #LENSBOLOP, Frosted Pagoda Lens #Cat. #LENSBOLF, Frosted Pillar Lens #Cat. #LENSSTPEF, Glare Guard #Cat. GG, Hex Cell Louvre Adaptor #Cat. HCL

HUNZA offers a comprehensive range of LED options and we regularly update the technology in line with the latest developments. Please refer to the Light Sources section of our website for the most up to date information on LED options for this luminaire.

Power Supply: 12 volt HUNZA Inground or HUNZA Wall Mount Transformer: not included.

Retro Option 110/240-12 volt ac silicon encapsulated electronic transformer built into the Retro base. Dimmable with a suitable dimmer.

Standards: IP66, AS/NZS61046

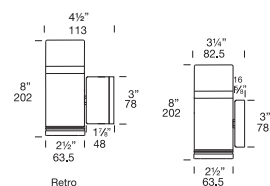



Cat. PGL/PGL and PGL/PGL/R

Pagoda Pagoda Lite

The Pagoda Pagoda Lite has two G4 lamps, which produce a general lighting effect. This luminaire is not for directional lighting. The lens is manufactured from high quality UV stable polycarbonate with stainless anti-glare mesh.

The luminaire is machined from a choice of 10mm (3/8") thick aluminium with a UV stable powder coated finish (10 standard colours), solid copper or 316 stainless steel with a clear, tempered, stepped glass lens and high temperature silicon gaskets.

The Retro is a 110/240-12 ac mains option suited to an installation where mounting a transformer is a problem, e.g. a brick wall where there is only the cable protruding out of the wall and it is not an option to recess the transformer or when replacing an existing light fitting. The base size increases in size to accommodate the encapsulated IP66 dimmable transformer.

Lifetime Warranty on Lens Breakage.

Accessories: Cable Joint Kit #CJK150, Wall Box Adaptor Plate #WBAP, Frosted Glass Lens #LENSBOLF.

HUNZA offers a comprehensive range of LED options and we regularly update the technology in line with the latest developments. Please refer to the Light Sources section of our website for the most up to date information on LED options for this luminaire.

Power Supply: HUNZA Wall Mount series WM100 – WM300 Double Insulated Safety Isolating Transformers. For internal mounting use HUNZA H20 or H50 internal transformers. Retro Option #/R – Integral 120/240 Volt 75 watt Electronic Transformer.

Standards: AS/NZ61046, IP66 

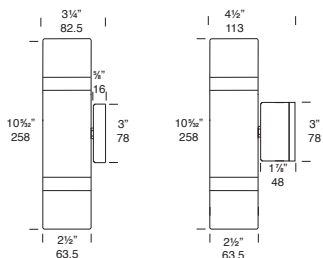

Cat. TWS and TWS/R

Twin Wall Spot

The Twin Wall Spot is a wall-mounted luminaire with two fully adjustable heads, each allowing 360 degree rotation and 0-90 degree elevation.

The luminaire is machined from a choice of 10mm (3/8") thick aluminium with a UV stable powder coated finish (10 standard colours), solid copper or 316 stainless steel with a clear, tempered, stepped glass lens and high temperature silicon gaskets.

Available in 12 volt or with a built-in 110 or 240 volt Retro transformer. The Retro is a 110/240 volt option suited to an installation where mounting a transformer is a problem or when replacing an existing fixture. The base depth increases to 48mm (1 7/8") to accommodate the encapsulated IP66 dimmable transformer.

All USA Retro wall mount fixtures are supplied with a wide backplate designed to suit a standard 3/0 or 4/0 junction box (this plate must be ordered separately for non-Retro fixtures – /WBAP).

Suitable for use with MR16 – 20, 35 or 50 watt lamps (35w max. in the USA) and is supplied with high quality European 5000-hour lamps.

Lifetime Warranty on Lens Breakage.

Accessories: Cable Joint Kit #CJK150, Wall Box Adaptor Plate #WBAP, Frosted Glass Lens #LENSSTEPF, Glare Guard #GG, Hex Cell Louvre Adaptor #HCL, IR Lamp #/IRC

HUNZA offers a comprehensive range of LED options and we regularly update the technology in line with the latest developments. Please refer to the Light Sources section of our website for the most up to date information on LED options for this luminaire.

Power Supply: HUNZA Wall Mount series WM100 – WM300 Double Insulated Safety Isolating Transformers. For internal mounting use HUNZA H20 or H50 internal transformers. Retro Option #/R – Integral 120/240 Volt 75 watt Electronic Transformer.

Standards: CE, EN60598, AS/NZ61046, IP66 

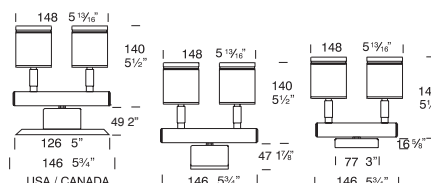

Cat. ETWS and ETWS/R

Euro Twin Wall Spot

The Euro Twin Wall Spot is a wall-mounted luminaire with two fully adjustable heads, each allowing 360 degree rotation and 0-90 degree elevation.

HUNZA Euro fixtures use a miniature MR11 lamp to achieve a contemporary, discreet appearance but are still able to provide excellent illumination.

Machined from 45mm (1 3/4") solid copper or 316 stainless steel, with a clear, tempered, glass lens, high temperature silicon gaskets and integral hex cell louvre.

The Euro Twin Wall Spot has a 60mm (3" in the USA) diameter mounting base.

Available in 12 volt or with a built-in 110 or 240 volt Retro transformer. The Retro is a 110/240 volt option suited to an installation where mounting a transformer is a problem or when replacing an existing fixture. The base depth increases to 48mm (1 7/8") to accommodate the encapsulated IP66 dimmable transformer.

All USA Retro wall mount fixtures are supplied with a wide backplate designed to suit a standard 3/0 or 4/0 junction box (this plate must be ordered separately for non-Retro fixtures – /WBAP).

Suitable for use with MR11 – 2 x 5, 10 or 20 watt lamp (10W max. in the USA).

Lifetime Warranty on Lens Breakage.

Accessories : Cable Joint Kit #CJK150, Wall Box Adaptor Plate #WBAP, Frosted Glass Lens #LENSEURF.

HUNZA offers a comprehensive range of LED options and we regularly update the technology in line with the latest developments. Please refer to the Light Sources section of our website for the most up to date information on LED options for this luminaire.

Power Supply: HUNZA Wall Mount series WM100 – WM300 Double Insulated Safety Isolating Transformers. For internal mounting use HUNZA H20 or H50 internal transformers. Retro Option #/R – Integral 120/240 Volt 75 watt Electronic Transformer.

Standards: AS/NZ61046, IP66 

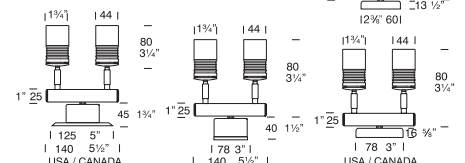



Cat. EDL and EDL/R



Cat. DL and DL/R



Cat. DL/MH

Euro Wall Down Lite

The Euro Wall Down Lite is an extra compact luminaire designed for situations where the fixture needs to be very unobtrusive or concealed. The luminaire is able to be wall mounted and has a fixed head to give a dramatic wash-lighting effect on walls – it can be directed either downwards or upwards.

HUNZA Euro fixtures use a miniature MR11 lamp to achieve a contemporary, discreet appearance but are still able to provide excellent illumination.

Machined from 45mm (1 3/4") solid copper or 316 stainless steel, with a clear, tempered, glass lens, high temperature silicon gaskets and integral hex cell louvre.

Available in 12 volt or with a built-in 110 or 240 volt Retro transformer. The Retro is a 110/240 volt option suited to an installation where mounting a transformer is a problem or when replacing an existing fixture. The base depth increases to 48mm (1 7/8") to accommodate the encapsulated IP66 dimmable transformer.

All USA Retro wall mount fixtures are supplied with a wide backplate designed to suit a standard 3/0 or 4/0 junction box (this plate must be ordered separately for non-Retro fixtures – /WBAP).

Suitable for use with a MR11 – 5, 10 or 20 watt lamp (10W max. in the USA).

Lifetime Warranty on Lens Breakage.

Accessories: Cable Joint Kit #CJK150, Wall Box Adaptor Plate #/WBAP, Frosted Glass Lens #LENSEURF.

HUNZA offers a comprehensive range of LED options and we regularly update the technology in line with the latest developments. Please refer to the Light Sources section of our website for the most up to date information on LED options for this luminaire.

Power Supply: HUNZA Wall Mount series WM100 – WM300 Double Insulated Safety Isolating Transformers. For internal mounting use HUNZA H20 or H50 internal transformers. Retro Option #/R – Integral 120/240 Volt 75 watt Electronic Transformer.

Standards: AS/NZ61046, IP66

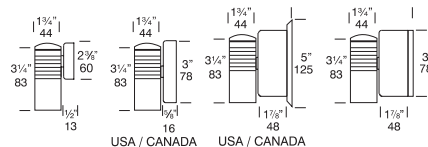

Wall Down Lite

The Wall Down Lite is a wall-mounted luminaire with a fixed head to give a dramatic wash-lighting effect on walls – it can be directed either downwards or upwards.

The luminaire is machined from a choice of 10mm (3/8") thick aluminium with a UV stable powder coated finish (10 standard colours), solid copper or 316 stainless steel with a clear, tempered, stepped glass lens and high temperature silicon gaskets.

Available in 12 volt or with a built-in 110 or 240 volt Retro transformer. The Retro is a 110/240 volt option suited to an installation where mounting a transformer is a problem or when replacing an existing fixture. The base depth increases to 48mm (1 7/8") to accommodate the encapsulated IP66 dimmable transformer.

All USA Retro wall mount fixtures are supplied with a wide backplate designed to suit a standard 3/0 or 4/0 junction box (this plate must be ordered separately for non-Retro fixtures – /WBAP).

Suitable for use with a MR16 20 watt lamp and is supplied with a high quality European 5000-hour lamp.

Lifetime Warranty on Lens Breakage.

Accessories : Cable Joint Kit #CJK150, Wall Box Adaptor Plate #/WBAP, Frosted Glass Lens #LENSSTEPF, Glare Guard #GG, Hex Cell Louvre Adaptor #HCL, IR Lamp #/IRC.

HUNZA offers a comprehensive range of LED options and we regularly update the technology in line with the latest developments. Please refer to the Light Sources section of our website for the most up to date information on LED options for this luminaire.

Power Supply: HUNZA Wall Mount series WM100 – WM300 Double Insulated Safety Isolating Transformers. For internal mounting use HUNZA H20 or H50 internal transformers. Retro Option #/R – Integral 120/240 Volt 75 watt Electronic Transformer.

Standards: CE, EN60598, AS/NZ61046, IP66

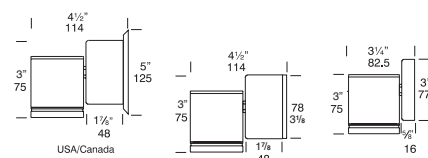

Down Lite Metal Halide

The Down Lite Metal Halide uses a 20 or 35 watt MR16 Metal Halide lamp with an integral, electronic ballast. This luminaire is easily mounted on a wall and provides a wash-lighting effect on the wall surface, either upwards or downwards, to highlight the surface texture or architectural features. The Down Lite Metal Halide has a fixed head.

The Metal Halide lamp is extremely efficient, using considerably less energy and outputting 3-4 times the light of a halogen lamp. The lamp also has a long 12,000 hour operational life, much higher than the average halogen lamp.

This luminaire has been constructed from highly durable machined components including solid copper, 316 stainless steel or powder coated aluminium (10 standard colours).

Accessories: Frosted Lens #LENSSTEPF, Glare Guard #/GG

Power Supply: Ballast built in: 230/240 volt AC 50Hz

Ballast built in 120 volt AC 60 Hz (USA/Canada).

Standards: AS/NZS 60598.2.2, IP66

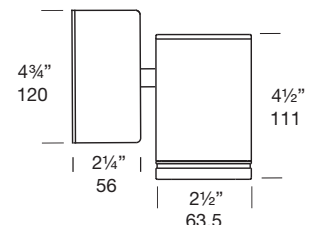



Cat. MOUSE

Mouse Lite

The Mouse Lite has been specifically designed to be mounted on vertical surfaces in gardens and landscapes. It has a shape that is pleasing to the eye and blends unobtrusively into any environment.

The luminaire is designed to be installed without the need for a wall cavity so it is ideal for situations where a recessed fixture cannot be used, e.g. step lighting in stone walls.

The solid bronze version is individually cast, giving each luminaire a unique finish and identity. The Mouse Lite is also available in brushed 316 stainless steel for a more contemporary look.

The Mouse Lite is supplied with a frosted, tempered glass lens and high temperature gasket.

The Mouse Lite is suitable for use with a G4 bi-pin 5, 10, 20 watt lamp (10W max. in the USA) and is supplied with a high quality European lamp.

A GU9 option can be also specified with a 25 watt lamp – note that operating temperature does increase with this option.

Accessories: Cable joint kit #CJK150.

HUNZA offers a comprehensive range of LED options and we regularly update the technology in line with the latest developments. Please refer to the Light Sources section of our website for the most up to date information on LED options for this luminaire.

Power Supply: HUNZA Buriable IG20 safety isolating transformer (single installation), multi installation with IG40, IG50, IG100, IG150 or IG200 safety isolating transformers or HUNZA Wall Mount series WM100 – WM300 Double Insulated Safety Isolating Transformers.

Standards: CE, EN60598, AS/NZ61046, IP66 

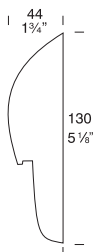

Cat. SIGN and SGNL/R

Sign Lite

The Sign Lite is a wall-mounted luminaire designed to illuminate signs, wall displays and building features. It is also ideal for lighting external barbecues.

The fully adjustable head is mounted on the end of a 500mm (19 3/4") arm, allowing 360 degree rotation and 90 degree elevation.

The luminaire is machined from a choice of 10mm (3/8") thick aluminium with a UV stable powder coated finish (10 standard colours), solid copper or 316 stainless steel with a clear, tempered, stepped glass lens and high temperature silicon gaskets.

Available in 12 volt or with a built-in 110 or 240 volt Retro transformer. The Retro is a 110/240 volt option suited to an installation where mounting a transformer is a problem or when replacing an existing fixture. The base depth increases to 48mm (1 7/8") to accommodate the encapsulated IP66 dimmable transformer.

All USA Retro wall mount fixtures are supplied with a wide backplate designed to suit a standard 3/0 or 4/0 junction box (this plate must be ordered separately for non-Retro fixtures – /WBAP).

Suitable for use with MR16 – 20, 35 or 50 watt lamps (35w max. in the USA) and is supplied with a high quality European 5000-hour lamp.

Lifetime Warranty on Lens Breakage.

Accessories: Cable Joint Kit #CJK150, Wall Box Adaptor Plate #/WBAP, Frosted Glass Lens #LENSSTEPF, Glare Guard #GG, Hex Cell Louvre Adaptor #HCL, IR Lamp #/IRC

HUNZA offers a comprehensive range of LED options and we regularly update the technology in line with the latest developments. Please refer to the Light Sources section of our website for the most up to date information on LED options for this luminaire.

Power Supply: HUNZA Wall Mount series WM100 – WM300 Double Insulated Safety Isolating Transformers. For internal mounting use HUNZA H20 or H50 internal transformers. Retro Option #/R – Integral 120/240 Volt 75 watt Electronic Transformer.

Standards: AS/NZ61046, IP66 

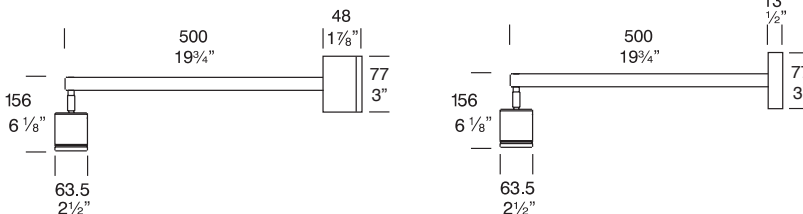



Cat. ESGNL and ESNGL/R

Euro Sign Lite

The Euro Sign Lite is an extra-compact luminaire designed for situations where the fixture needs to be very unobtrusive or concealed. This luminaire has been developed for lighting signs, wall displays, building highlights and external barbecues.

This luminaire has a fully adjustable head allowing 360 degree rotation and 90 degree elevation. HUNZA Euro fixtures use a miniature MR11 lamp to achieve the compact dimensions but are still able to provide excellent illumination.

This luminaire has been constructed from highly durable machined components including solid copper, 316 stainless steel or powder coated aluminium (10 standard colours).

Accessories: Cable Joint Kit #CJK150 , Frosted Lens #Cat. LENSEURF

HUNZA offers a comprehensive range of LED options and we regularly update the technology in line with the latest developments. Please refer to the Light Sources section of our website for the most up to date information on LED options for this luminaire.

Power Supply: HUNZA Inground or Wall Mount Transformer: not included.

Standards: IP56/IP66 

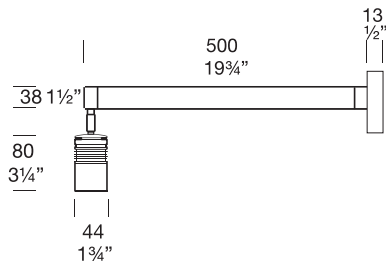

Cat. MOUSESQ

Mouse Lite Square

The Mouse Lite Square has been specifically designed to be mounted on vertical surfaces in gardens and landscapes. Its shape is pleasing to the eye and blends unobtrusively into any environment.

The luminaire is designed to be installed without the need for a wall cavity so it is ideal for situations where a recessed fixture cannot be used, e.g. step lighting in stone walls.

The Mouse Lite Square is available in bronze and brushed 316 stainless steel for a more contemporary look, and is supplied with a frosted, tempered glass lens.

The Mouse Lite Square is available in 12 volt or with a built-in 110 or 240 volt Retro transformer. The Retro is a 110/240 volt option suited to an installation where mounting a transformer is a problem or when replacing an existing fixture.

Suitable for use with a G4 bi-pin 5, 10, 20 watt lamp (10W max. in the USA) and is supplied with a high quality European lamp.

A GU9 option can be also specified with a 25 watt lamp – note that operating temperature does increase with this option.

Accessories: Cable joint kit #CJK150.

HUNZA offers a comprehensive range of LED options and we regularly update the technology in line with the latest developments. Please refer to the Light Sources section of our website for the most up to date information on LED options for this luminaire.

Power Supply: HUNZA Buriable IG20 safety isolating transformer (single installation), multi installation with IG40, IG50, IG100, IG150 or IG200 safety isolating transformers or HUNZA Wall Mount series WM100 – WM300 Double Insulated Safety Isolating Transformers. Retro Option #/R – Integral 120/240 Volt 75 watt Electronic Transformer.

Standards: CE, EN60598, AS/NZ61046, IP66 

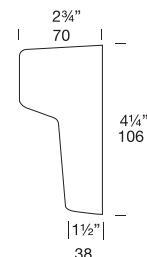



Tree Mount

These luminaires can be safely mounted on to trees enabling dramatic lighting effects of trunk, canopies and other high objects. They can also be used for moonlighting effects creating a dappled pattern of light on the ground.



Cat. HL

Hanging Lite

The Hanging Lite is a single spotlight which can be easily hung from high vantage points, including trees, fences and over-hangs, providing a dramatic wash lighting effect.

The luminaire is machined from a choice of 10mm (3/8") thick aluminium with a UV stable powder coated finish (10 standard colours), solid copper or 316 stainless steel with a clear, tempered, stepped glass lens and high temperature silicon gaskets.

Comes standard with a 3 metre cable.

Suitable for use with a MR16 20, 30 or 50 watt lamp (maximum 20w in the USA) and is supplied with a high quality European 5000 hour lamp.

Lifetime Warranty on Lens Breakage.

Accessories: Cable Joint Kit #CJK150, Frosted Lens #LENSSTEPF, Glare Guard #Cat. GG, Hex Cell Louvre #Cat. HCL.

Standards: IP68 

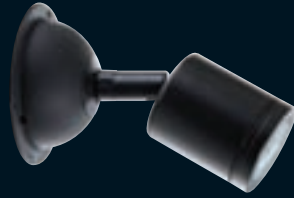
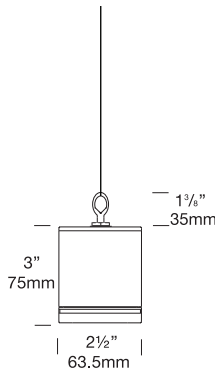

Cat. SSP/T

Tree Mount Kit

The NPS Spot (see page 11) can be installed on a tree trunk using the tree mount kit to increase illumination in the higher parts of a tree canopy or for cross lighting onto other high objects.

A cable connection can be made at the rear of the dome.

The Kit consists of a mounting dome and three special 316 stainless steel lag bolts. The bolts initially distance the dome 40mm (1 5/8") out from the trunk, which allows the tree room to grow without causing any harm.

The HUNZA Tree Mount Kit is constructed from black UV stable glass filled polypropylene. There is sufficient space for a cable connection under the dome.

An alternative mounting option is the Tree Mount Kit Rubber Strap. The kit consists of a mounting dome and a one metre adjustable rubber strap, which expands as the tree grows.

It is suitable for use with aluminium, copper and 316 stainless steel luminaires.

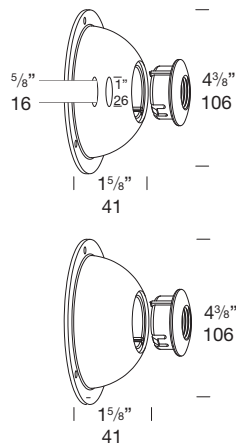

Cat. TMMH

Tree Mount Metal Halide

The Tree Mount Metal Halide is a tree-mountable version of the Spike Spot Adjustable Metal Halide, which uses a 20 or 35 watt MR16 Metal Halide lamp with integral, electronic ballast.

This luminaire is designed for installing on tree trunks to increase illumination in the higher parts of a tree canopy or for cross lighting onto other high objects. It is installed with a special tree-mounting kit and has a fully adjustable head allowing 360 degree rotation and 0-90 degree elevation adjustment.

The Metal Halide lamp is highly efficient, using considerably less energy and outputting 3-4 times the light of a halogen lamp.

The luminaire is machined from a choice of 10mm (3/8") thick aluminium with a UV stable powder coated finish (10 standard colours), solid copper or 316 stainless steel with a clear, tempered, stepped glass lens and high temperature silicon gaskets.

An alternative mounting option is the Tree Mount Kit Rubber Strap (#TMMH/RS). The kit consists of a mounting dome and a one metre adjustable rubber strap, which expands as the tree grows.

Both kits come with a female adaptor for NPS thread.

Accessories: Cable Joint Kit #CJK150, Frosted Lens #LENSSTEPF, Glare Guard #/GG.

Power Supply: Ballast built in: 230/240 volt AC 50Hz Ballast built in: 120 volt AC 60 Hz (USA/Canada).

Standards: AS/NZS 60598.2.2, IP66 

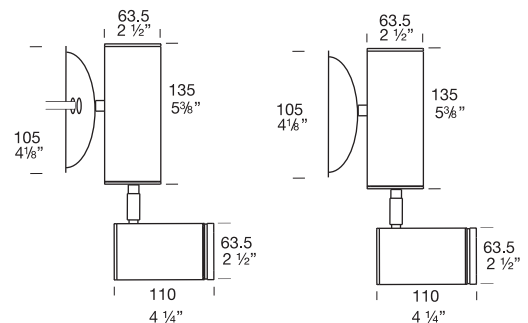

Ceiling Mount



The HUNZA E-Lite range of recessed downlights are ideal for installation in eaves, soffits, entranceways, verandahs, carports or covered decks. They can also be used in bathrooms, kitchens or anywhere that moisture transfer or decibel rating is a minimum requirement.



Cat. EAVESQ



Cat. EAVE



Cat. EAVE105

E-Lite Square

The E-Lite Square is a recessed downlight ideal for installation in eaves, soffits, entrance ways, verandahs, carports or covered decks. It can also be used in bathrooms, kitchens or where moisture transfer or decibel rating is a minimum requirement.

This luminaire is machined from a choice of 10mm ($\frac{3}{8}$) thick aluminium with a UV stable powder coated finish, solid copper or 316 stainless steel with a clear, tempered, flush glass lens and high temperature silicon gaskets. The 316 stainless steel E-Lite Square is electro-polished to increase corrosion protection.

Accessories: Cable Joint Kit #CJK150, Frosted Lens #LENSSTEPF.

HUNZA offers a comprehensive range of LED options and we regularly update the technology in line with the latest developments. Please refer to the Light Sources section of our website for the most up to date information on LED options for this luminaire.

Power Supply: HUNZA H20, H40 or H50 Transformer: not included.

Standards: IPX5 NZECP 54 = CA, SCB 100mm HBX 75mm, REC 135mm DB = RW30.

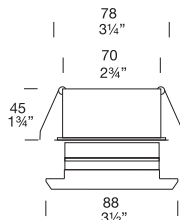

E-Lite

The E-Lite is a recessed downlight ideal for installation in eaves, soffits, entrance ways, verandahs, carports or covered decks. It can also be used in bathrooms, kitchens or where moisture transfer or decibel rating is a minimum requirement.

This luminaire is machined from a choice of 10mm ($\frac{3}{8}$) thick aluminium with a UV stable powder coated finish, solid copper or 316 stainless steel with a clear, tempered, flush glass lens and high temperature silicon gaskets. The 316 stainless steel E-Lite is electro-polished to increase corrosion protection.

A larger 105mm ($4\frac{1}{8}$) flange version, E Lite 105, is also available and has been designed to fit a standard 90mm ($3\frac{1}{2}$) cut-out.

Accessories: Cable Joint Kit #CJK150, Frosted Lens #Cat. LENSSTEPF.

HUNZA offers a comprehensive range of LED options and we regularly update the technology in line with the latest developments. Please refer to the Light Sources section of our website for the most up to date information on LED options for this luminaire.

Power Supply: HUNZA H20, H40 or H50 Transformer: not included.

Standards: IPX5 NZECP 54 = CA, SCB 100mm, HBX 75mm, REC 135mm, DB = RW30

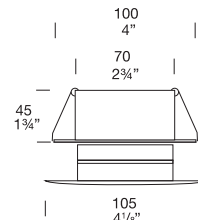
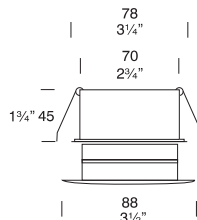



Cat. EAVEMH



Cat. EAVE105MH

E-Lite Metal Halide

The E-Lite Metal Halide is a recessed downlight ideal for installation in eaves, soffits, entrance ways, verandahs, carports or covered decks. It can also be used in bathrooms, kitchens or where moisture transfer or decibel rating is a minimum requirement.

Metal Halide lamps are highly energy efficient light sources using less energy and outputting 3-4 times the light of a halogen lamp.

The luminaire is machined from a choice of 10mm (3/8") thick aluminium with a UV stable powder coated finish (10 standard colours), solid copper or 316 stainless steel with a clear, tempered, flush glass lens and high temperature silicon gaskets. The 316 stainless steel E-Lite Metal Halide is electro-polished to increase corrosion protection.

This luminaire has a MR16 GX10 20 or 35 watt lamp.

A larger 105mm (4 1/8") flange version, E Lite Metal Halide 105, is also available and has been designed to fit a standard 90mm (3 1/2") cut-out.

Accessories: Cable Joint Kit #CJK150, Frosted Lens #Cat. LENSSTEPF

Power Supply: Remote Ballast: 230-240 volt ac 50Hz
Remote Ballast: 120 volt ac 60Hz (USA/Canada)

Standards: AS/NZS 60598.2.2, IP66

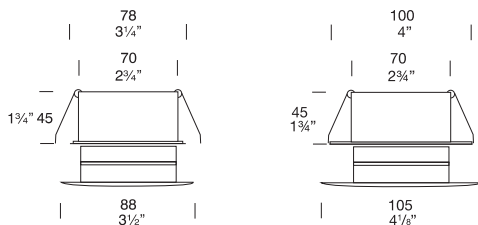

Underwater and Marine

All HUNZA luminaires are highly waterproof however there are particular models that are designed specifically for use in underwater lighting or specialised marine applications. HUNZA provides dedicated fixtures for pool lights, pond lighting, water features and fountains as well as special luminaires for installation in the cockpits of large boats and vessels. It is critical that pool lights, underwater lighting and marine lights all have particularly high IP ratings and durability to ensure high water protection.



Cat. CL



Cat. CPL

Cabin Lite

The Cabin Lite has been designed for installation in large marine craft such as yachts and launches.

The fixture uses a 5–20 watt halogen lamp and a clear glass lens to provide illumination in the cabin.

The luminaire is supplied with a mounting canister that facilitates ease of installation and provides an attractive finish with no visible fixing screws. The luminaire body is held in the canister by two 'O' rings and can be easily withdrawn for re-lamping.

The aluminium canister is anodised for protection and is open at the top to allow heat to escape. The Cabin Lite has a water protection rating of IP66 but the ventilated canister design means that it is only suitable for installation inside the boat cabin.

The Cabin Lite is machined from 316 stainless steel and is supplied with a tempered glass lens, silicon gasket, a marine grade aluminium mounting canister and a lock ring.

Suitable for use with a G4 bi-pin lamp – 5, 10, 20w lamps and is supplied with a high quality European lamp.

Lifetime Warranty on Lens.

Accessories: Cable Joint Kit #CJK150, Frosted Lens #LENSURF.

HUNZA offers a comprehensive range of LED options and we regularly update the technology in line with the latest developments. Please refer to the Light Sources section of our website for the most up to date information on LED options for this luminaire.

Power Supply: HUNZA H20 and H50 for internal mounting only.

Standards: IP66

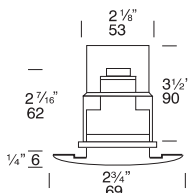

Cockpit Lite

The Cockpit Lite has been designed for installation in large marine craft such as yachts and launches.

The fixture uses a 5 watt bi-pin lamp and a frosted glass lens to create a glow in the cockpit at night.

The luminaire is supplied with a mounting canister that facilitates ease of installation and provides an attractive finish with no visible fixing screws. The luminaire body is held in the canister by two 'O' rings and can be easily withdrawn for re-lamping.

The marine grade aluminium mounting canister is anodised for protection and is fully enclosed with a cable gland which provides an IP66 water protection rating. If the cockpit fills with water the canister will not compromise the waterproof integrity of the room. Complete with 300 mm (1ft) of cable (other lengths available on request).

The Cockpit Lite is machined from 316 stainless steel and is supplied with a tempered glass lens, silicon gasket, a PVC mounting canister and a lock ring.

Suitable for use with a G4 bi-pin lamp 5 watt lamp and is supplied with a high quality European lamp.

Lifetime Warranty on Lens.

Accessories: Cable Joint Kit #CJK150, Clear Lens #LENSEURC.

HUNZA offers a comprehensive range of LED options and we regularly update the technology in line with the latest developments. Please refer to the Light Sources section of our website for the most up to date information on LED options for this luminaire.

Power Supply: HUNZA H20 and H50 for internal mounting only.

Standards: IP66

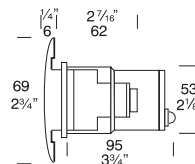



Cat. POOL



Cat. PLCAN

Pool Lite

The Pool Lite is a recessed underwater luminaire designed for installation in swimming pools, fully submersible and tested to an IP68 water protection rating. It is made of stainless steel, electro-polished to provide extra protection against chemicals in the water and is supplied with a multi-purpose PVC Wet Niche mounting canister.

The Pool Lite is machined from 9mm (11/32") thick 316 stainless steel with a tempered glass stepped lens, high temperature silicon gaskets, and is supplied with an engineering-grade PVC mounting canister (wet niche).

Complete with six metres (20ft) of submersible cable (other lengths available on request).

Suitable for use with MR16 20, 35, 50 watt lamps and is supplied with a high quality European 5000 hour lamp.

Lifetime Warranty on Lens Breakage.

Accessories: Cable Joint Kit #CJK150, Frosted Lens #LENSSTEPF, Hex Cell Louvre Adaptor #HCL, IR Lamp #/IRC

HUNZA offers a comprehensive range of LED options and we regularly update the technology in line with the latest developments. Please refer to the Light Sources section of our website for the most up to date information on LED options for this luminaire.

Power Supply: HUNZA H20, H40 and H50 for internal mounting only. Check with your Local Electrical Authority for pool zone installation regulations.

Standards: CE, EN60598, IP68, AS1939 

Warning: Out of balance pool chemicals may cause surface corrosion on the luminaire. In the case of salt water an increase in water temperature of 10 degrees will double the corrosion factor. 316 stainless steel is suitable for water with up to 1000 parts per million of chloride. Where an automatic chlorinator is used, excess chlorine may produce corrosion on the metal surface. The electro-polish treatment applied to the finish increases the protection against corrosion by up to 33%.

The Pool Lite Canister can be installed in three different types of pool wall:

- 1) Fibreglass Pools, 2) Existing Concrete Pools, 3) New Concrete Pools.

The luminaire is held into the PVC canister by two 'O' rings and is easily withdrawn for lamp replacement. There are no mounting screws visible on the flange to spoil the aesthetics of the luminaire and up to 600mm (24") of cable can be coiled up inside the canister, enabling the lamp to be changed without the need to empty the pool.

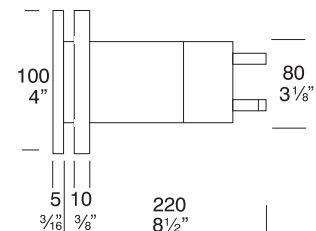
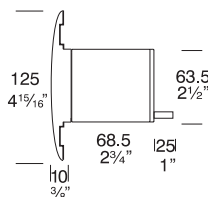



Cat. POND



Cat. POND/W

Pond Lite

The Pond Lite is an adjustable underwater luminaire designed for installation in ponds, fountains and water features. It is fully submersible, tested to an IP68 water protection rating and the adjustable head can be rotated 360 degrees and elevated up to 90 degrees.

The Pond Lite adds life and interest to water features and a uniquely tranquil quality to the landscape.

The standard version of the luminaire is fixed in place by means of an adjustable yoke.

There is also a weighted version (POND/W) with a heavy base that allows the luminaire to be held down by gravity instead of being fixed into place. With this design there is no need to drill fixing holes (which may cause the pond to leak) and the luminaire can be relocated more easily.

The luminaire is machined from a choice of 10mm (3/8) thick aluminium with a UV stable powder coated finish (10 standard colours), solid copper or 316 stainless steel with a clear, tempered, stepped glass lens, high temperature silicon gaskets and a 3 metre (10ft) submersible cable (longer lengths supplied on request).

This Luminaire is suitable for use with a MR16 20, 35 or 50 watt lamp and is supplied with a high quality European 5000 hour lamp.

Lifetime Warranty on Lens Breakage.

Accessories: Cable Joint Kit #CJK150, Frosted Lens #LENSSTEPF, Glare Guard #GG, Hex Cell Louvre Adaptor Kit #HCL, HUNZA Super Spike #SSP/G, IR Lamp #/IRC

HUNZA offers a comprehensive range of LED options and we regularly update the technology in line with the latest developments. Please refer to the Light Sources section of our website for the most up to date information on LED options for this luminaire.

Power Supply: HUNZA Buriable IG20 safety isolating transformer (single installation), or multi installation with IG40, IG100, IG150 or IG200 safety isolating transformers or HUNZA Wall Mount series WM100—WM300 Double Insulated Safety Isolating Transformers.

Standards: CE, EN60598, IP68 

PLEASE NOTE: Pool chemicals, hard water or salt water may damage the powder coated finish. Stainless steel fittings should be used in these situations.

Aluminium fixtures are not UL approved for underwater installation in the USA and Canada.

Copper luminaires are not suitable for installation in a pond with fish.

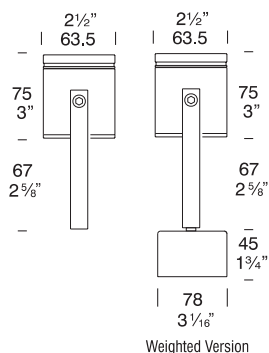

Transformers

Low voltage luminaires provide a very safe and simple system for installing outdoor lighting, due to the fact that the majority of the power feed cables are carrying only a 12 volt current and therefore can be installed close to the ground surface. HUNZA offers a range of transformers designed to make the installation of HUNZA low voltage luminaires both safe and easy. HUNZA also provides luminaires with integral transformers for situations where the use of a remote transformer is not practical.

Installers should note that low voltages have a tendency to drop below optimum levels over long cable distances and care must be taken to compensate for this by increasing the cable size or output voltage at the transformer. A HUNZA Voltage Drop calculator can be obtained free of charge from your local distributor or refer to our website at www.hunza.co.nz.

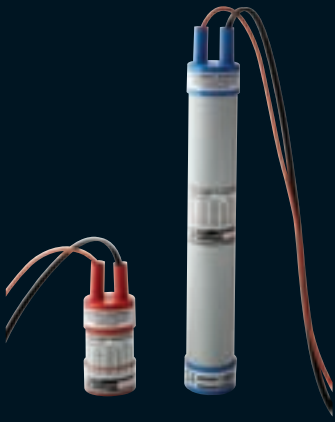

Cat. IG20, IG40, IG50, IG150 and IG200

Inground Transformer

The Inground Transformer is a buriable unit designed to provide 12 volt power for low voltage luminaires in landscape lighting installations. This transformer is recommended for situations where a Wall Mount unit is either not practical or desirable.

Inground Transformers are available in either 120v 60Hz or 240v 50 Hz and in seven wattages: 20, 40, 50, 80, 100, 150, and 200 watt (each transformer has an IG designation). Models IG100, IG150 and IG200 have individual 50 watt transformers inside the unit with a single output cable, (e.g. IG100 has two 50 watt transformers) instead of one large transformer.

These transformers are “double Insulated safety Isolating” transformers and are suitable for total burial (in locations where this is allowed).

The HUNZA In-ground Transformer has a high IPX7 water protection rating. It is critical that all wire connections are made completely waterproof by the use of a HUNZA CJK150 cable joint kit.

For advice on wiring requirements please contact your local HUNZA distributor for a free HUNZA Volt Drop calculator.

Input: 120 volt 60Hz or 230-240 volt 50 Hz.

Output: 12 volts AC – 50 watt 4.2 amp / 40 watt 3.3 amp / 20 watt 2.0 amp.

Standards: AS3108, IPX7

Transformers carry a five year replacement warranty.

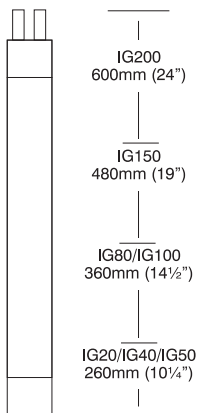

Cat. H20, H40 and H50

Lighting Transformer

The H Series is an internal (non waterproof) 12 volt lighting transformer designed to operate at the lowest possible temperature.

Due to its low profile the H Series transformer can be fitted through a 63mm (2 1/2") diameter hole.

Wiring is made much easier by use of a 25 amp (6mm or 1/4" diameter terminal) connector-block, which facilitates quick and easy wire-in and loop-out connections.

For interior use only.

Input: 120 volt 60Hz or 230/240 volt 50 Hz.

Output: 12 volts AC – 50 watt 4.2 amp / 40 watt 3.3 amp / 20 watt 2.0 amp.

Standards: AS3108, W/2306

Transformers carry a five year replacement warranty.

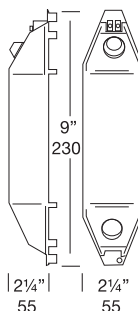

Cat. LET75/120V & LET75/240V

LET75 Electronic Transformer

The LET75 (also known as HET75) is a miniature, 75 watt electronic transformer suitable for powering HUNZA luminaires in situations where the transformer is protected from moisture, e.g. inside a waterproof junction box, in a ceiling or in a cavity wall.

The LET75 is available in either 120/12 volt 60Hz or 240/12volt 50/60Hz version, has a built-in safety shutdown system for overload and is dimmable with a leading edge dimmer. It will power either 1 x 10 watt, 1 x 20 watt, 2 x 20 watt, 1 x 35 watt, 1 x 50 watt or 2 x 35 watt lamps.

Input: 120 volt 60Hz or 240 volt 50/60 Hz.

Output: 12 volts AC – 75 watt.

Standards: AS/NZ61046, EMC55015, EN61046, Z246, UL1838

Transformers carry a five year replacement warranty.

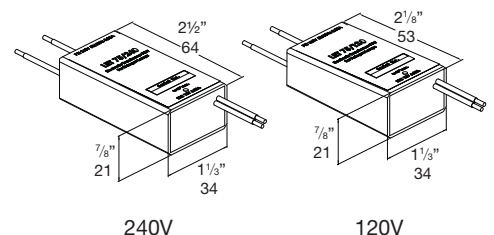



Cat. /R

Retro Wall Transformer

The Retro Wall Transformer 120/240 volt version is available for HUNZA wall mounted fixtures, for example the Wall Spot, Wall Down Lite, Pillar Lite, Pagoda Lite, Euro Wall Spots and Euro Pillar Lite.

With an electronic transformer built into the luminaire base (canopy), this option is designed for wall installations where mounting a remote transformer is not practical, e.g. in a brick wall where there is no space to recess the transformer or where an existing 120/240 volt light fitting needs to be replaced.

Retro luminaires are a very economical way to overcome potentially expensive installation problems.

With this option the base/canopy increases in depth to 48mm (1 7/8"). All USA Retro wall mount fixtures are supplied with a wide backplate designed to suit a standard 3/0 or 4/0 junction box (this plate must be ordered separately for non-Retro fixtures—/WBAP)

The electronic transformer is 120 or 240/250 volt ac and is encapsulated in silicon. It is rated IP66 against water ingress, has a built-in safety shutdown system for overload and is dimmable with a leading edge dimmer. It will power either 1 x 10 watt, 1 x 20 watt, 2 x 20 watt, 1 x 35 watt, 1 x 50 watt or 2 x 35 watt lamps.

Input: 120 volt 60Hz or 230–240 volt 50 Hz.

Output: 12 volts AC—75 watt.

Standards: AS/NZ61046, EMC55015, EN61046, Z246, IP66 

Transformers carry a five year replacement warranty.



Cat. WM100, WM200 and WM300

Wall Mount Transformer

The Wall Mount Transformer is an above-ground, waterproof unit designed to provide 12 volt power for HUNZA low voltage luminaires in landscape lighting installations. Wall Mount Series Transformers have a black, glass-reinforced, UV stable nylon case, which provides durability, UV resistance and a low surface temperature.

It is compact and unobtrusive in appearance, blending well into any outdoor setting.

The electrical components are fully encapsulated in the casing for protection against weather and irrigation systems.

The Wall Mount Series is suitable for 120/240 volt 50/60 Hz. operation and is available in 100, 200 and 300 watt versions.

A key feature of this transformer is multi-tap output, providing the choice of either 12, 13 or 14 volt secondary output. This allows much greater flexibility in compensating for voltage drop on long cable runs. For advice on wiring requirements please contact your local HUNZA distributor for a free HUNZA Volt Drop calculator.

The unit has thermal protection for the primary side of the transformer with fuse protection for the secondary. There are 25mm (1") and 32mm (1 1/4") conduit entries to allow for different cable requirements.

HUNZA Wall Mount series are "Double Insulated Safety Isolating" transformers.

Input: 120 volt 60Hz or 230–240 volt 50 Hz.

Output: 12 volts AC.

Standards: CE, AS/NZ61046, IP66 

Transformers carry a five year replacement warranty.

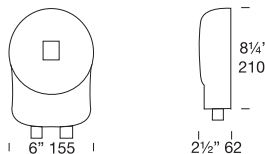

Cat. /R

Retro Pole Transformer

The Retro Pole 120/240 volt version is available for HUNZA pole mounted fixtures, for example, the 700mm Bollard, Border Lite, Euro Single and Twin Pole Lites, Single and Twin Pole Lites, Twig Lite, Tier Lite and Walkway Lite.

This option is designed for installations where mounting the transformer is a problem and avoids the need to bury a transformer, e.g. where there is a long cable run required and a 120/240 volt power cable needs to be installed.

A situation such as a car park where a ring main has been installed would be ideal for this luminaire.

The electronic transformer is a double insulated safety-isolating transformer and complies to EMC regulations and has a built-in safety shutdown system if it is overloaded.

It will power either 1 x 10 watt, 1 x 20 watt, 2 x 20 watt, 1 x 35 watt, 1 x 50 watt or 2 x 35 watt lamps.

Input: 120 volt 60Hz or 230–240 volt 50 Hz.

Output: 12 volts AC—75 watt.

Standards: AS/NZ61046, EMC55015, EN61046, Z246, IP56

Transformers carry a five year replacement warranty.

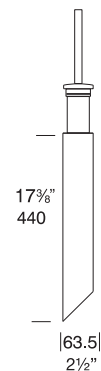

Accessories

HUNZA provides a wide range of optional accessories to allow the user to customise luminaires according to their individual installation requirements and lighting applications. Accessories include different lenses to vary lighting effects, attachments for glare control, different lamping options, optional installation equipment and an Anti-Syphon feature for enhancing moisture protection.





Cat. GG

Glare Guards

These Glare Guards are a modular accessory suitable for many HUNZA MR16 luminaires.

They serve two purposes: firstly, to protect the eye from the direct glare or sparkle effect from the lamp; secondly, to provide an adjustable shield to direct unwanted light away from passers-by.

When the Glare Guard is fitted to a ground-mounted fixture such as a Pole Lite or Spike Spot, it helps the luminaire to disappear into the landscape or flowerbed, so only the illumination effect is observed.

This accessory is ideal for a Wall Down Lite or Pillar Lite in an entrance to reduce the harshness of the illumination.

The Glare Guard is also available in a Moonlight option (#GGML), which is a cylindrical shape instead of having the front cut at an angle.

This version is used when a luminaire such as an NPS Spot or Pond Lite is mounted or suspended in a tree to create moonlighting effects.

Available in a choice of UV stable powder coated finish (10 standard colours), solid copper or 316 stainless steel.

The Glare Guard does not change the IP rating of the luminaire when fitted.

The Glare Guard allows the use of higher wattage lamps on HUNZA MR16 landscape fixtures supplied in the USA and Canada. When this accessory is fitted, the maximum wattage increases from 20w to 35w for fixtures such as the Spike Spots, NPS Spot, Single and Twin Pole Lites and Twin Bar Lite.

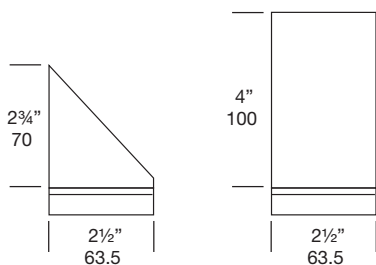

Cat. HCL

Hex Cell Louvre Kit

The Hex Cell Louvre Kit consists of an extension component for the luminaire body, a Hex Cell Louvre insert and an extra lens and gasket (O-ring).

The main purpose of the Louvre accessory is to protect the eye from the sideways glare emitted from the lamp filament, without dramatically changing the look of the luminaire.

The kit also allows a second lens accessory to be fitted to the luminaire.

The Kit is supplied standard with an extra clear lens, however other lens options are available such as a Diffuser, Linear Spread Lens, Dichroic Colour Lens and Frost Lens.

Available in a choice of UV stable powder coated finish (10 standard colours), solid copper or 316 stainless steel.

When a Hex Cell Louvre Adaptor is fitted it does not affect the IP rating of the luminaire.

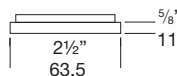

Cat. SSP/G

Super Spike

The Super Spike is a multi purpose unit which adds significant stability when used to mount the NPS Spot Adjustable or HUNZA pole mount luminaires in loose or sandy soil.

The Super Spike is supplied in kit form with two snap-in adaptors to be used with either 1/2" NPS luminaires or pole-style luminaires.

The dome junction box is designed to facilitate effortless cable connections, while being discreetly hidden by the dome.

The HUNZA Super Spike is constructed from black UV stable glass filled polypropylene.

There is sufficient space for a cable connection under the dome.

It is suitable for use with aluminium, copper and 316 stainless steel luminaires.

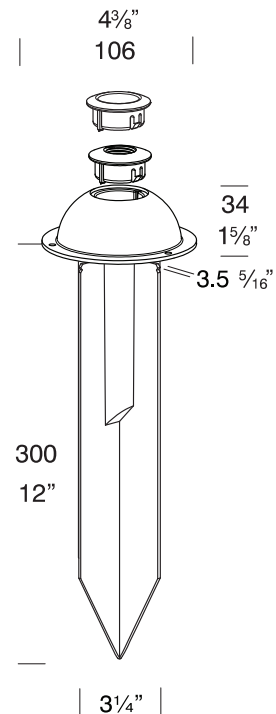

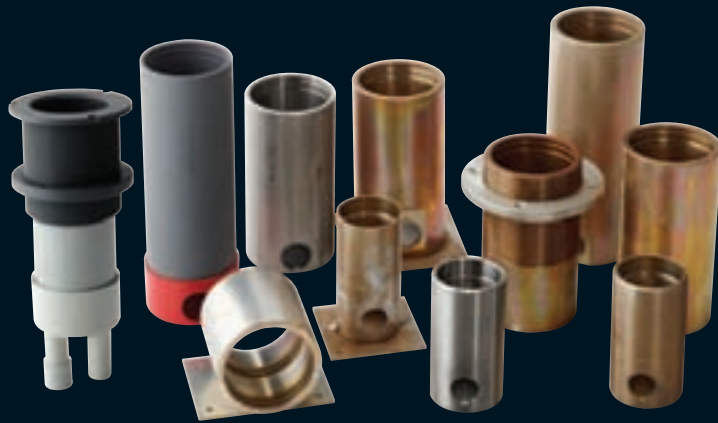

Cat. SSP/T

Mounting Canisters

These mounting canisters provide an efficient and professional method of mounting HUNZA recessed luminaires.

The mounting canister is installed during the rough-in stage of construction, avoiding damage to the luminaire itself, and the final stages of installation are completed at a later stage.

The canister holds the luminaire in place by means of two high-temperature, heavy-duty gaskets and this allows installation with no visible screws on the front trim.

Some HUNZA recessed luminaires are supplied complete with canisters but in other instances the canisters need to be specified as an option due to the variety of choices. Please check the specification sheets carefully when ordering recessed luminaires.

Canister options are as follows:

STEP LITE CANISTERS:

SLCAN – Step Lite Canister Aluminium (for concrete/stone)

SLCAN 200 – Step Lite Canister 200 Aluminium (for concrete/stone)

CANSS – Step Lite Canister 316 stainless steel (for limestone or locations near the sea)

DKCAN – Deck Mount Canister (for wood, decks etc)

FLUCAN – Fluorescent Canister PVC (for fittings with Fluorescent/LED lamps only)

SLCAN/INT – Internal Stud Canister (for cavity walls with studs)

ELCAN – Euro Canister (for MR11 Euro recessed luminaires in stone/concrete)

ELDKCAN – Euro Deck Mount Canister (for MR11 Euro recessed luminaires in wood)

FLOOR AND PATH LITE CANISTERS:

FLCAN – Floor/Path Lite Canister Aluminium (for new concrete)

FLCAN 200 – Floor Canister 200 Aluminium

SLCAN – Step Lite Canister Aluminium (for core drill installation)

CANSS – Step Lite Canister 316 stainless steel (for limestone or locations near the sea)

DKCAN – Deck Mount Canister (for wood, decks etc)

FLUCAN – Fluorescent Canister PVC (for fittings with Fluorescent/LED lamps only)

ELCAN – Euro Canister (for MR11 Euro recessed luminaires in stone/concrete)

ELDKCAN – Euro Deck Mount Canister (for MR11 Euro recessed luminaires in wood)

The Deck Mount Canister is adjustable and is suitable for use in varying thicknesses of timber – from 10mm (3/8") – 75mm (3").

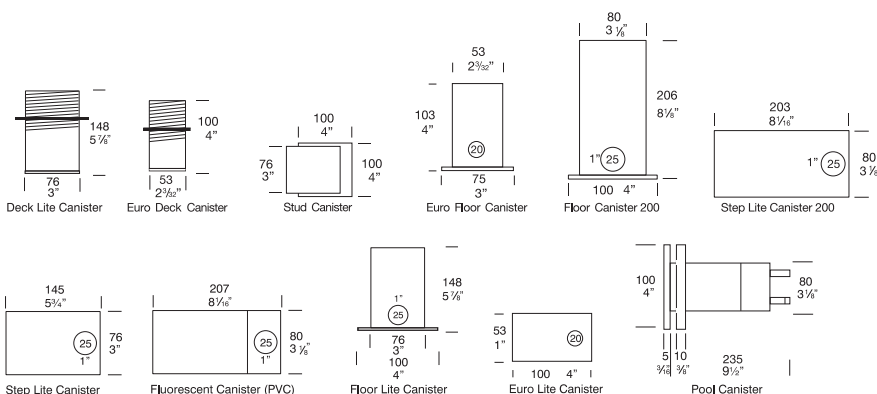

Tree Mount Kit

The Tree Mount Kit is used to mount the NPS Spot Adjustable in a tree to create moon lighting effects, to light high canopies or for high-level cross illumination.

A cable connection can be made at the rear of the dome.

The Kit consists of a mounting dome and three special 316 stainless steel lag bolts. The bolts initially distance the dome 40mm (1 5/8") out from the trunk, which allows the tree room to grow without causing any harm.

The HUNZA Tree Mount Kit is constructed from black UV stable glass filled polypropylene. There is sufficient space for a cable connection under the dome.

An alternative mounting option is the Tree Mount Kit Rubber Strap. The kit consists of a mounting dome and a one metre adjustable rubber strap, which expands as the tree grows.

It is suitable for use with aluminium, copper and 316 stainless steel luminaires.

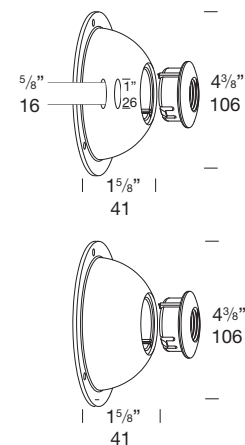



Lens Options



Cat. A/S

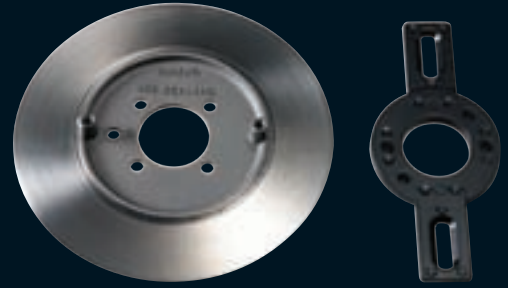

Cat. WBAP

Dichroic Colour

Coloured lenses add a creative dimension to landscape lighting, providing the ability to enhance the appearance of outdoor scenes in different ways. HUNZA offers a choice of four dichroic coloured lens options, including Red (#LENSR), Blue (#LENSB), Yellow (#LENSY) and Green (#LENSG).

Frosted/Diffuser

Most HUNZA fixtures can be specified with an optional frosted or a diffuser lens. The effect of these lenses is to soften the light beam, providing a more diffused lighting effect with less beam definition.

Linear Spread

HUNZA also offers a Linear Spread Lens (#LENSSPREAD) as a further option on many MR16 luminaires. The effect of this lens is to expand and flatten the light beam to cover a wider surface on one plane. The spread effect can be varied by rotating the lens inside the luminaire.

All the above lenses are easily installed by replacing the standard clear lens supplied with the luminaire, or they can be specified when ordering.

Stepped Lenses

Many HUNZA fixtures are now supplied with a stepped lens, which offers increased glass strength and lower maintenance. Stepped lenses can significantly reduce the maintenance requirements of outdoor landscape luminaires by providing a flush finish with the flange. This prevents water pooling and depositing dirt on the surface of the lens, which restricts light output.

Anti-syphon

Many ground mounted luminaires are fitted with a specially designed Anti-Syphon system to reduce the likelihood of water entering the fixture through the cable. Where the Anti-Syphon is not fitted as standard, it can be specified in some instances as an option. This system is designed to counter the problem of wicking (siphoning) of water through the supply cable into the lamp housing, causing water to condense and dramatically shorten the life of the lamp, lamp holder and luminaire. Siphoning is caused by the expansion and contraction of air inside the luminaire due to heat generated by the lamp. As the lamp heats up, the air expands and is forced down into the supply cable. The problem manifests itself when the fixture enters the cooling cycle and the air cools to create considerable suction inside the lamp housing and supply cables. The joint between the luminaire cable and the cable from the transformer becomes critical at this stage because a leaking or poor cable joint will allow water to be siphoned up the cable directly into the luminaire. Unless this cycle is broken this action will dramatically reduce the life of the luminaire.

Wall Box Adaptor Kit (for USA and Canada)

The Wall Box Adaptor Kit is designed to allow easy installation of wall mounted fixtures to standard USA 3/0 and 4/0 junction boxes. The kit includes a mounting strap and the necessary screws. Available in standard finishes to suit all fixtures. Supplied with Retro wall mounted fixtures but must be ordered separately for 12 volt luminaires.

Light Sources

HUNZA offers a comprehensive range of lamp options including fluorescent, LED and halogen allowing you to choose the appropriate light source for your specific application. Because LED and fluorescent lamps operate at very low temperatures and are very energy efficient, it makes them ideal for use in public areas and where safety is paramount. Fluorescent lamp life is typically 6,000 to 10,000 hours and LED lamps from 30,000 to 100,000 hours, so maintenance is reduced.



Dedicated



Plug In



Metal Halide

HUNZA offers long-life, low energy ceramic metal halide lamps for selected luminaires.

Metal halide lamps are extremely efficient, using less energy and out-putting 3-4 times more light than an equivalent wattage halogen lamp. For instance, a 20 watt metal halide can produce the same amount of light as a 75 watt halogen lamp, making it suitable for lighting tall trees or structures. Metal halide lamps also have a long 12,000-hour operational life, much higher than the average halogen lamp life of 3000-5000 hours, as well as excellent colour rendition, UV control and a consistent colour over its lifetime.

MR16 metal halide lamps come with a robust GX10 base.

The SafeTouch series uses PGJ5, GX8.5 or G12 metal halide lamps, depending on the model and specification.

HUNZA metal halide luminaires are supplied with electronic ballasts, which deliver 30 percent longer lamp life (increasing lamp life to 15,000 hours) and have excellent "end of life" control of the lamp.

LED Options

HUNZA offers a comprehensive range of high output LED options for all Luminaires except SafeTouch.

LED's are very energy efficient and have a significantly low heat output. They are ideal for installation in difficult-to-access places due to their exceptionally long operational life, ensuring minimal maintenance is required to keep them operational. They are also ideal for public spaces where low heat surfaces are important.

Note: We regularly update the technology in line with the latest developments. Please refer to the light sources section of our website for the most up-to-date information.

Dedicated LED – HUNZA offer a dedicated LED system as an option for our MR16 luminaires using an integrated Cree LED array. This system has the advantage of a very long diode life and high light output.

Plug In LED – MR16, MR11 and G4 bi-pin plug in LED lamps are also available and can be easily fitted into most HUNZA luminaires.

Fluorescent Luminaires

Selected luminaires are available in fluorescent version, suitable for connection directly to either 240 or 120 volt electrical supply.

The lamp has a medium screw base (E26 or E27) and is rated at 7 or 8 watts.

Fluorescent lamps operate at very low temperatures and are very energy efficient, making them ideal for use in public areas and where safety is paramount.

Typical fluorescent lamp life is 6,000 to 10,000 hours, so maintenance is reduced.

The following luminaires are available in Fluorescent version:

- Bollard 300**
- Bollard 700**
- Floor Lite**
- Floor Lite Square**
- Square on Square**
- Pagoda Lite**
- Path Lite**
- Step Lite**
- Step Lite Square**
- Step Lite Eyelid**
- Step Lite Louvre**
- Step Lite Louvre Square**
- Step Lite Solid Eyelid**
- Step Lite Square Solid Eyelid**
- Tier Lite.**



Halogen

MR16

Many HUNZA luminaires are designed to use the popular MR16 type of low-voltage halogen lamp with built-in reflector. These lamps are available in a range of wattages from 20w to 50w and a choice of 3 beam angles, which includes Narrow Spot (10°), Flood (38°) and Wide Flood (60°).

HUNZA MR16 luminaires are supplied with a high quality 5000-hour European lamp.

MR11

HUNZA Euro luminaires are designed for use with the MR11 type of low-voltage halogen lamp with built-in reflector. These lamps are available in either 10W or 20w and a choice of 2 beam angles, which includes Narrow Spot (10°) and Flood (30°).

AR1-11

The HUNZA IG1-11 luminaire is designed to use the AR1-11 type of low-voltage halogen lamp with built-in reflector. These lamps are available in a range of wattages from 50w to 100w and a choice of 3 beam angles, which includes Narrow Spot (8°), Flood (24°) and Wide Flood (45°).

Please note that the HUNZA IG1-11 fixture is no longer supplied with the 100 watt AR1-11 lamp as standard. This lamp has now been replaced with the 60 watt IR (infra-red) lamp, which provides the same light output with lower energy usage and operating temperature.

Halogen IRC

HUNZA MR16 luminaires are also available with Osram Infra-Red (IRC) lamps, which provide a 75% improvement in energy efficiency and heat output over standard halogen lamp technology. This has been achieved by the use of a special coating on the reflector.

Lamp details are as follows:

20w IRC - equivalent to the light output of a 35 watt standard halogen and the heat output of a 20 watt lamp

35w IRC - equivalent to the light output of a 50 watt standard halogen and the heat output of a 35 watt lamp

50w IRC - equivalent to the light output of a 75 watt standard halogen and the heat output of a 50 watt lamp

Beam Angles

Available beam angles in the IRC lamps are as follows: 12, 24 or 36 degree.

Halogen Beam Angles

MR11 GU4

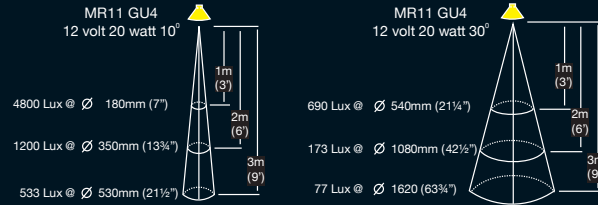



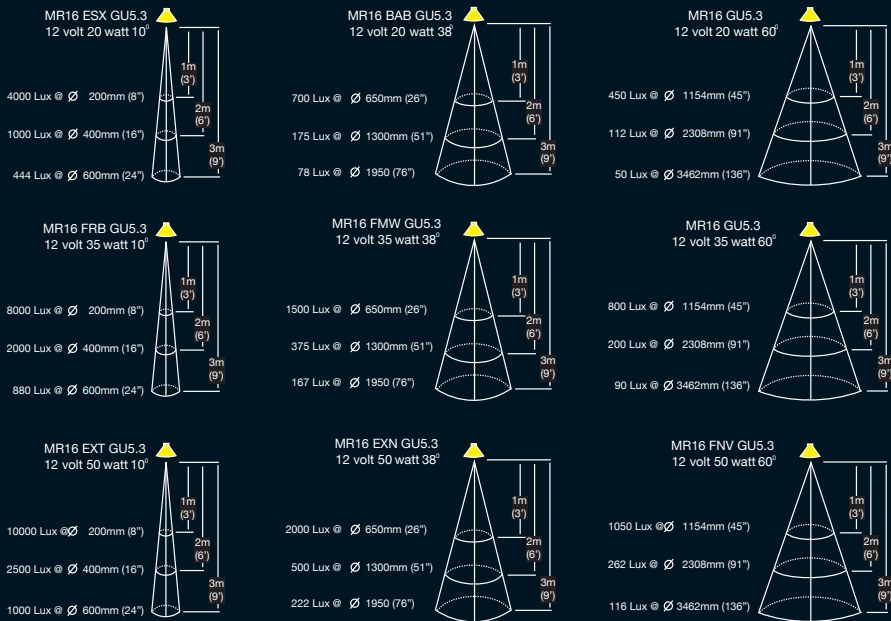

MR16 GU5.3

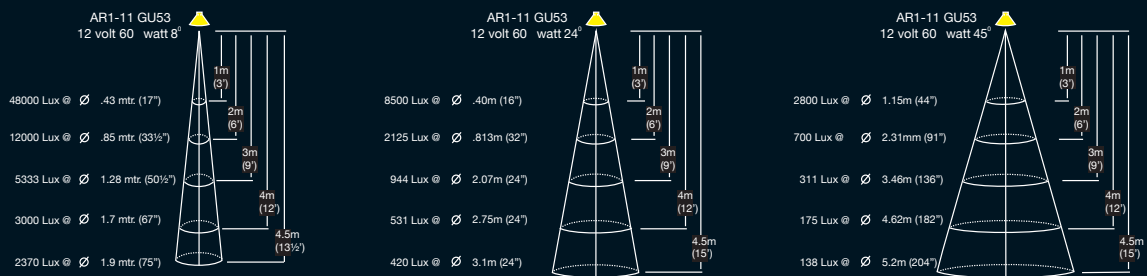

AR1-11 GU53



INDEX OF PROTECTION RATINGS			
	First Numeral		Second Numeral
Number/Symbol	Degree of Protection	Number/Symbol	Degree of Protection
4	(a) Protection against contact by tools, cables or the like, more than 1/16" thick. (b) Dust proof against ingress of small foreign bodies.	4 	Splash proof: liquid splashed from any direction shall have no harmful effect.
5 	(a) Complete protection against contact (b) Dust proof: Protection against harmful deposits of dust: dust may enter but not in sufficient amount to interfere with satisfactory operation	5 	Jet proof: water protected by a nozzle from any direction (under stated conditions) shall have no harmful effect.
6 	(a) Complete protection against contact (b) Dust tight: Protection against ingress of dust	6	Watertight equipment: protection against conditions on ship decks etc. Water from heavy seas or power jets shall not enter the enclosure under prescribed conditions.
IP CODES <ul style="list-style-type: none"> • Degree of protection in form IPXX. • Protection against contact or ingress of water respectively is specified by replacing first or second X by digit number tabled e.g. IP2X defines an enclosure giving protection against water or liquid. • Example: an underwater light should be rated at IP68 NOTE: Use the table for general guidance only		7 	Protection against immersion in water: it shall not be possible for water to enter the enclosure under stated conditions of pressure and time.
		8	Protection against indefinite immersion in water under specified pressure: it shall not be possible for water to enter the enclosure.

HUNZA Lighting Warranty Policy

HUNZA Five Year Warranty*

All HUNZA aluminum luminaires with a UV stable powder-coat finish have a five-year replacement warranty, subject to standard conditions listed below.

HUNZA Ten Year Warranty*

All HUNZA solid copper and stainless steel luminaires have a ten-year replacement warranty, subject to standard conditions listed below.

HUNZA Lifetime Warranty

All glass lenses supplied with HUNZA luminaires have a lifetime replacement warranty against breakage

*Standard Conditions:

1. The environment in which the fixture is to be installed must be considered carefully when selecting the finish. Solid copper and stainless steel luminaires are recommended for high-risk environments such as near salt water.
2. Warranty excludes lamps and lamp holders, which are consumable items.
3. Warranty excludes impact damage (except for lenses), incorrect installation and incorrect re-assembly.
4. Warranty on transformers is limited to 5 years.

Please refer to our website for full warranty details www.hunza.co.nz



HUNZA Factory

130 Felton Mathew Ave
Glen Innes
Auckland 1740
New Zealand
Ph: 64 9 528 9471
Fax: 64 9 528 9361
hunza@hunza.co.nz
www.hunza.co.nz

For local distributor details in your country please consult the contacts page of our website.

NOTE: Specifications may change without notification

©2010 Copyright HUNZA Production Ltd.



Designed and Manufactured in New Zealand

Distributor