

Stormtech™ 'SLIM LINE' ARCHITECTURAL GRATES & DRAINS

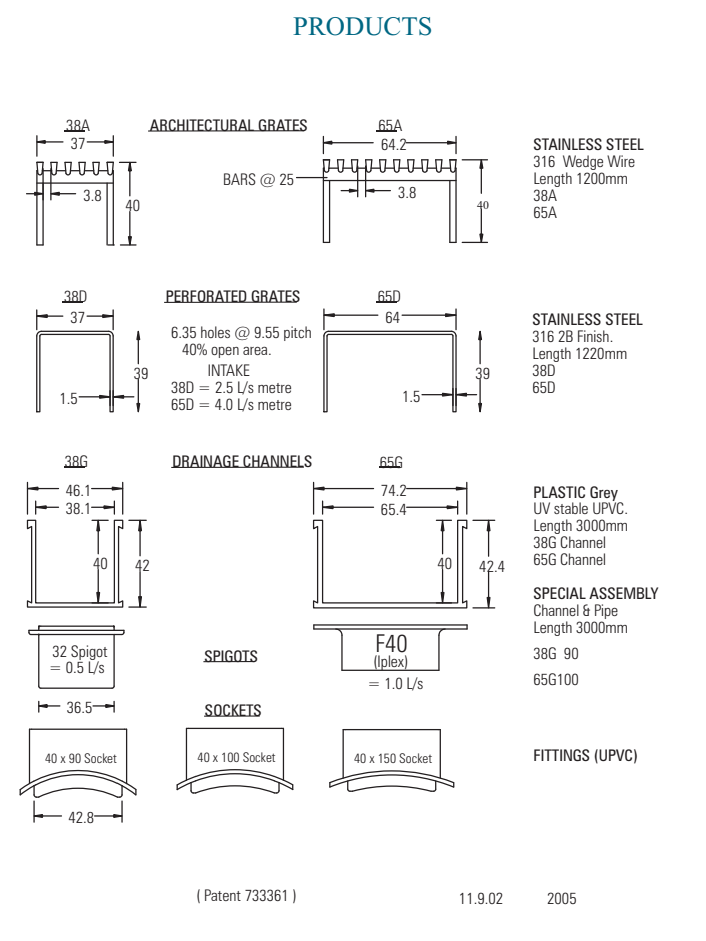

Indoor

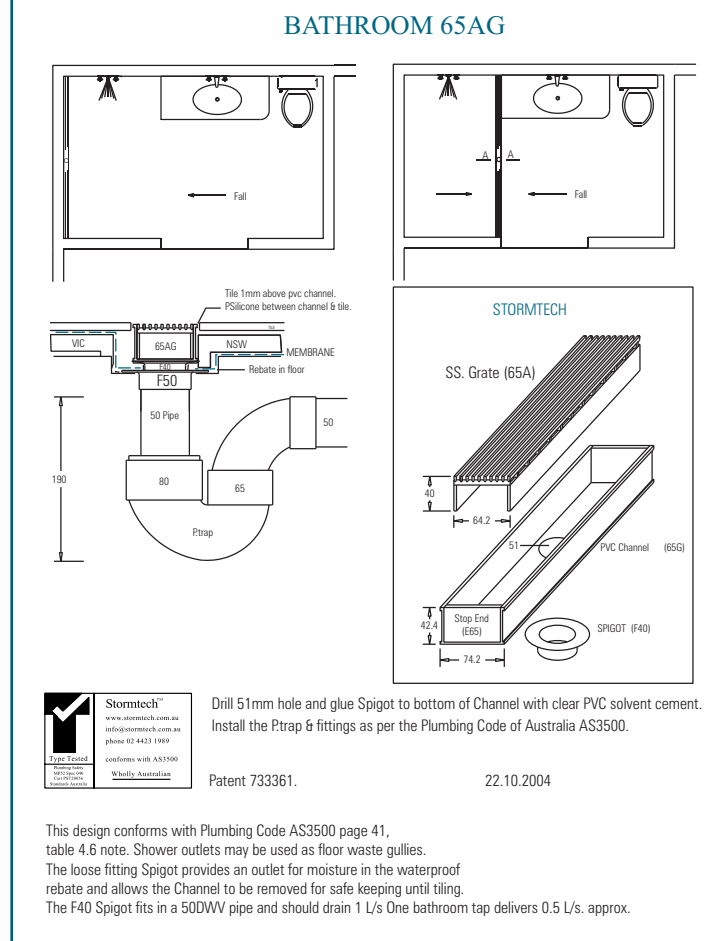
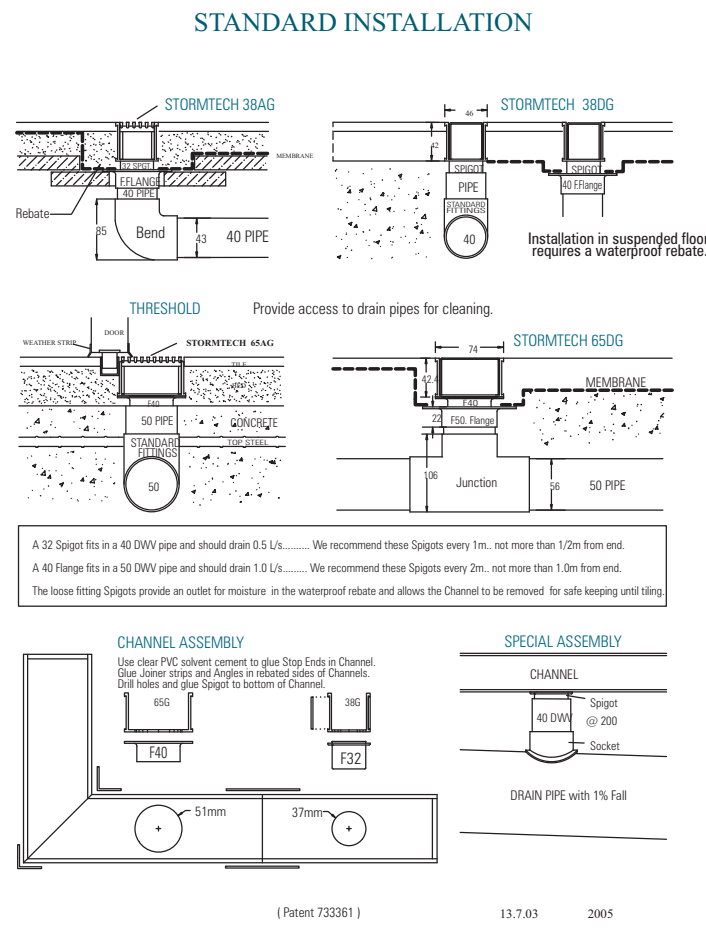
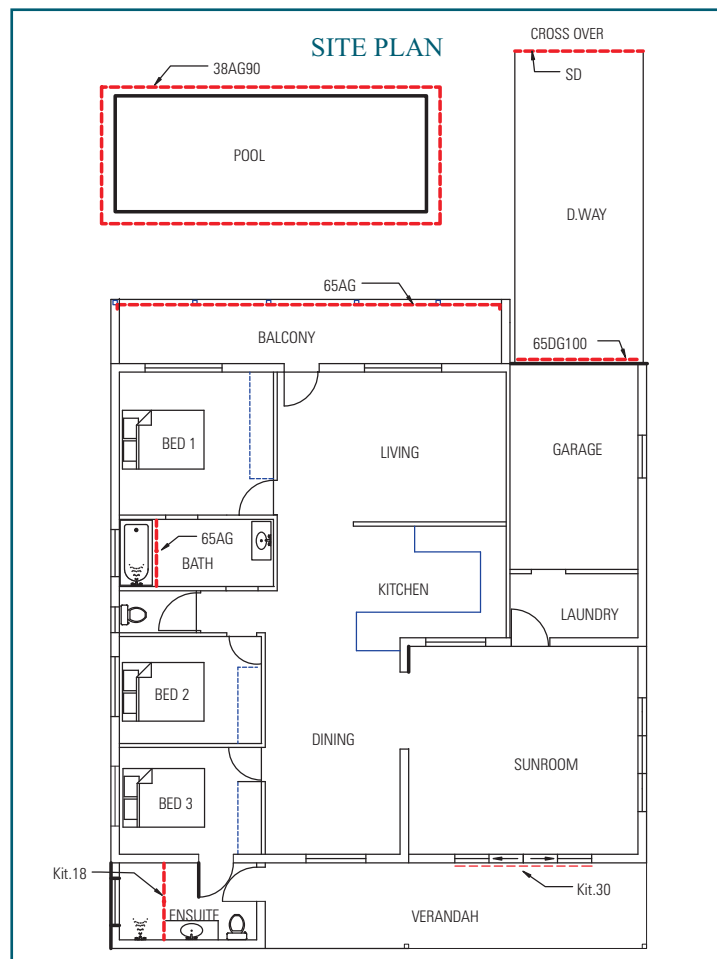

Outdoor



Stormtech Pty Ltd

186 Old Southern Road Worrigeer NSW 2540
 p.61 (0) 2 4423 1989 f. 02 4423 5552
 email troy@stormtech.com.au
 www.stormtech.com.au

Winner of DesignMark® 2004 Australian Design Awards

Product Information



65AG



38AG



38DG



65DG

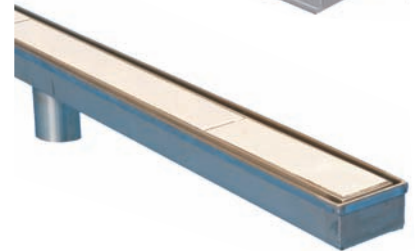

Tile Insert Frame



Special Assembly



Slot Drain

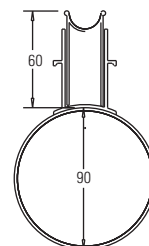
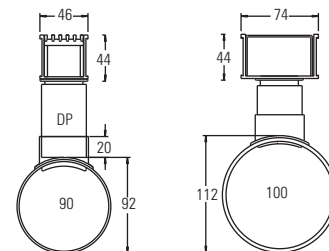
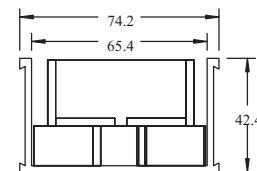
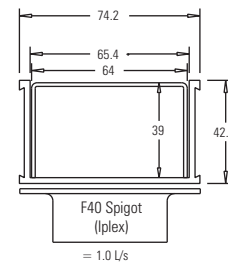
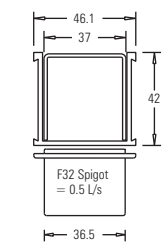
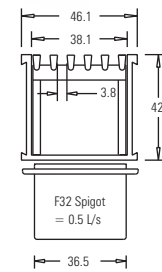
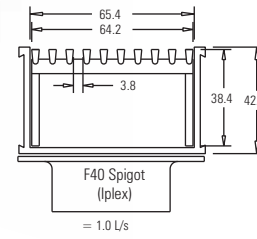

Applications

Bathrooms

Stormtech created a world first by developing the lineal grate for bathrooms. High quality finish blends well with contemporary styles. Allows use of larger tiles. Provides uniform plain of fall. Creates easy access for special needs.

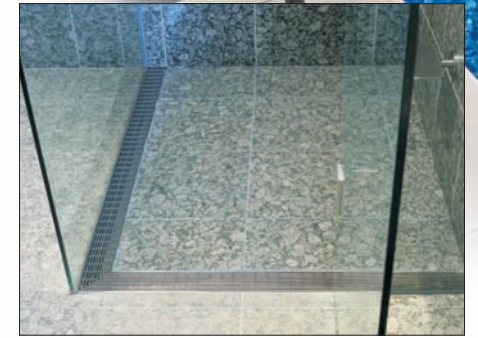

Suspended slab & Balcony

Narrow profile blends with designed contours. Removes need for 'spitters'. Allows uniform plain of fall, removing 'dishing' created by standard drains



Threshold

Stormtech has another first, with the ability to create a level entrance. Narrow profile minimises impact on design. Assists access for wheelchairs and walking frames.

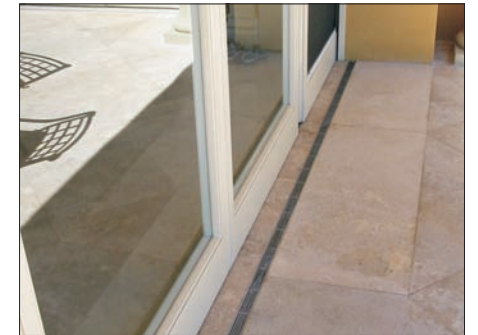

Pedestrian & vehicle areas

The narrow profile and high efficiency creates an aesthetically pleasing solution to the traditional 'grated drain'. Loading suitable up to Class C.

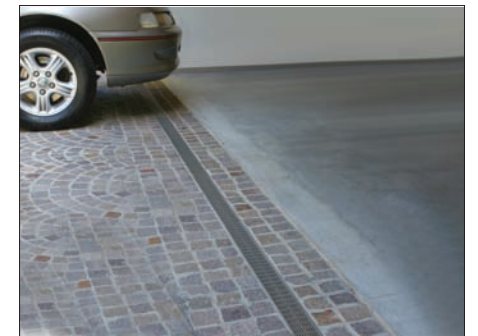

Pools & paved areas

Incredibly high efficiency gained whilst maintaining an extremely narrow profile. Designer finish blends with surrounds whilst having maximum effectiveness.

