aluminium range selector

trend[®] windows & doors



TREND[®]
WINDOWS

& DOORS

contents

Introduction

Trend® Windows & Doors 2

Trend® Brands

Trend®

Aluminium Windows & Doors 3

Quantum XP®

Aluminium Windows & Doors 67

Xtreme®

Bushfire Windows & Doors 89

Crestlite®

Commercial 113

Thermashield®

Energy Solutions 117

SoundMizer®

Acoustics Solutions 125

Special Products 129

Product Installation 134

Window Ratings 134

Care & Maintenance 135

Guarantee 136

Trend® National Customer Assistance Centre

13 72 74

www.trendwindows.com.au

email: info@trendwindows.com.au

Note: Size Range Sheets for individual product follow each section.

All windows and doors are viewed from the outside. Hardware contained in photography may vary from State to State due to supplier, supplier's availability or maybe by special request. Trend® Windows & Doors Pty Ltd reserve the right to make changes to product(s) without notice.

trend[®] windows & doors

Create a welcoming ambience and sense of style in your home with Trend[®] quality aluminium windows and doors.

Choose from the largest, most comprehensive range in Australia with more design and performance features than ever before.

Trend[®] offers experience, quality and service that you can rely on. Trend[®] understands that choosing the right windows and doors for your home is critical, so here are some pointers to assist you.

Design and Style

Colour, style, size and shape of windows and doors enhance the charm and character of your home, both inside and out. Choosing the clean lines of aluminium, you can create exactly the look and feel you want for your home, with just the right amount of natural light.

Trend[®] Windows colour catalogue offers limitless options to ensure that you make the perfect choice.

Energy Efficiency

Enhancing the comfort of your home depends significantly on the amount of ventilation and insulation provided by your windows and doors. A cool breeze in summer is refreshing and staying warm in winter is essential. With Australia's diverse climate it is important to consider the best design options for your location and individual needs.

Trend[®] can offer advice on how to save money on energy costs by choosing the appropriate frame material, glass type and style for your particular climatic conditions.

Safety and Security

Your family needs to feel safe and secure, so it is essential to use locks and frames that will deter unwanted entry and select the right type of glass.

Trend[®] can assist you with these decisions as Trend[®] products adhere to the highest standards of safety and security.

Your Individual Needs

You may have specific needs, such as arches, glazing bars or bay windows – or a specific colour, glass or hardware.

Trend[®] provides you with complete design flexibility.

Quality and Durability

Windows and doors should be strong and well made, providing you with many years of effortless performance. All Trend[®] windows and doors carry the Australian Window performance label.

Trend[®] will inspire you with the options available and provide you with the expertise to create a perfect environment in your home.



Our membership of the Australian Window Association is your guarantee of performance.

strength, style, sophistication

Aluminium has always offered the advantage of durability and affordability. Now, Trend's latest range of Aluminium windows and doors sees this versatile material come of age - setting new benchmarks for style and performance.

You'll find the crisp, clean lines of Trend's contemporary aluminium the equal of timber when it comes to capturing just the right look or feeling. In fact, we offer the widest range in Australia. So, whatever type of home you're creating - traditional or modern - Trend® Aluminium windows and doors are the perfect solution for your needs making it simple to add the essential sense, light and space that has become the hallmark of the classic Australian home.

And when it comes to practicalities you'll find everything you expect from aluminium and more.

Everything from energy efficiency to security is enhanced by the latest thinking in frames, glazing and hardware.

If you don't see exactly what you want in this catalogue simply ask us to make it for you. As Australia's largest window and door company with nine factories we can custom make any design - adding your personal touch in choice of colours, glazing or hardware. Also feel free to ask our advice about energy efficiency, acoustics or specific climate requirements and see why Trend® aluminium windows and doors have set a new trends in strength, style and sustainability.

trend[®] aluminium

Aluminium Windows

Double Hung	5
Awning	15
Casement	21
Sliding	25
Bifold Windows	31
Bay Windows	35
Louvres	39

Aluminium Doors

Sliding	43
Alfresco Stacker Sliding Door	49
Provincial [™] Hinged	55
Bifold Doors	59
Entry Doors	65

double hung windows



Optional wide style with horns shown here

classic perspectives

Trend® Double Hung Windows offer a timeless elegance equally at home in contemporary dwellings as in more traditional houses.

The flexible design lets you adjust airflow to the season and your frame of mind. Open the top, the bottom or both sashes. Interlocking top and bottom sashes also provide added strength and security.

All with the benefits of aluminium, low maintenance, durability and a broad choice of powder-coated finishes. You can also create that timber look and feel by combining classic round profile Ovolo colonial bars or horns with wide style sashes.

features & benefits

- 1 **Energy Efficiency Options**
Trend® Thermashield® in various glazing styles are available to help reduce energy consumption. Trend® Thermashield® means greater control, bigger savings and most importantly one less thing to worry about. Energy efficient options to u-value of 3.6 and SHGC 0.33 are available for Trend® Double Hung window.
- 2 **Acoustic Options**
SoundMizer® acoustic solutions in various STC ratings, are available to STC 31 for Trend® Double Hung window. SoundMizer® acoustic solutions can reduce aircraft, highway traffic, railway and other annoying noise problems. For information or technical details contact Trend®.
- 3 **Key locks**
All Trend® Wide Style Double Hung Windows are available with optional key lock that can be keyed to match other Trend® aluminium windows. Vent locks are available for Trend® Double Hung Windows.
- 4 **Complementary Accessories**
 - 180° non-load bearing couplers, two types available for added mullion strength when required.
 - 135° & 90° non-load-bearing corner couplers to suit bay and kitchen windows.
 - 100mm aluminium architraves for replacement window installations.
 - Adjustable aluminium storm mould.
 - Aluminium 180° and 90° mullion covers to hide load-bearing posts.
- 5 **Interlocking Meeting Rails**
The interlocking meeting rails on the sashes combine together when closed to improve the overall weather performance strength. The sashes by-pass to facilitate easy internal glass cleaning.
6. **Weather Sealed for Full Protection**
All sashes are fitted with weatherpile seals to keep the dust and water where they belong, on the outside.
- 7 **Options**
Colonial Bar and Federation Bar Layouts are available. Easy to fit flyscreens. Wide range of powdercoat finishes.

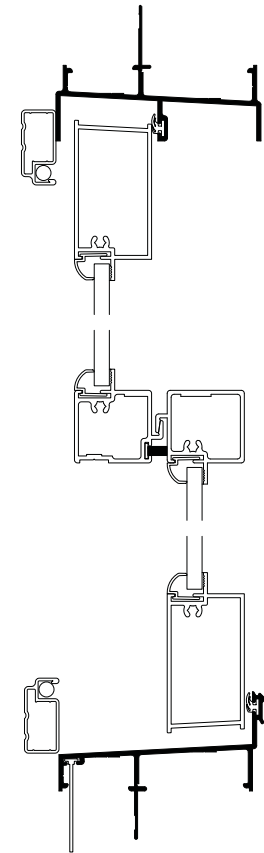

ordering details

All windows are illustrated as viewed from outside. Codes shown are for plain windows. Manufactured from 64mm aluminium extrusion. The first two numbers of code indicate approximate height, the last two numbers indicate approximate width.

Sash Style Options:

Standard option is:
eg window code AWD0906
O indicates Ovolo D/Hung sash with Ovolo Glazing Bar, eg window code AOWD0906CL
T indicates Thermashield® double glazed

sash style, eg window code ATWD0906
* Double Glazing not available with ovolo bar.

Bar Options:

CL indicates Colonial Bar.
Eg window code AWD0906CL
FED indicates Federation Bar.
Eg window code AWD0906FED

Configuration Options:

DF indicates Double Hung/Fixed
FD indicates Fixed/Double Hung
DD indicates Double Hung/Double Hung

DFD indicates Double Hung/Fixed/Double Hung
DDD indicates Double Hung/Double Hung/Double Hung
F indicates Fixed
T after the size indicates a Transom

General:

Black hardware is supplied as standard
Vent lock option is available

* Refer to Special Products on page 129 for Bar Layout Options

wide style double hung

STUD OPENING WINDOW	656	780	899	1131	1484	1722	2186	2545
	600	724	843	1075	1428	1666	2130	2489
989	ATD0906	ATD0907	ATD0909	ATD0911	ATDF0914	ATDF0917	ATDFD0921	ATDFD0925
1076	ATD1006	ATD1007	ATD1009	ATD1011	ATDF1014	ATDF1017	ATDFD1021	ATDFD1025
1247	ATD1206	ATD1207	ATD1209	ATD1211	ATDF1214	ATDF1217	ATDFD1221	ATDFD1225
1418	ATD1406	ATD1407	ATD1409	ATD1411	ATDF1414	ATDF1417	ATDFD1421	ATDFD1425
1590	ATD1506	ATD1507	ATD1509	ATD1511	ATDF1514	ATDF1517	ATDFD1521	ATDFD1525
1856	ATD1806	ATD1807	ATD1809	ATD1811	ATDF1814	ATDF1817	ATDFD1821	ATDFD1825
2098	ATD2006	ATD2007	ATD2009	ATD2011	ATDF2014	ATDF2017	ATDFD2021	ATDFD2025
2098 2042	ATD2006T	ATD2007T	ATD2009T	ATD2011T	ATDF2014T	ATDF2017T	ATDFD2021T	ATDFD2025T

NSW/VIC/SA/ACT

designer double hung

STUD OPENING WINDOW		656	780	899	1131	1484	1722	2186	2545	2902
		600	724	843	1075	1428	1666	2130	2489	2846
989	933									
1076	1020									
1247	1191									
1418	1362									
1590	1534									
1856	1800									
2098	2042									
2098	2042									

ordering details

All windows are illustrated as viewed from outside. Codes shown are for plain windows. Manufactured from 64mm aluminium extrusion. The first two numbers of code indicate approximate height, the last two numbers indicate approximate width.

Sash Style Options:

Standard option is:
Eg window code AOD0906
O indicates Ovolo D/Hung sash with Ovolo Glazing Bar. Eg window code AOD0906CL

Bar Options:

CL indicates Colonial Bar.
Eg window code AOD0906CL
FED indicates Federation Bar.
Eg window code AOD0906FED

Configuration Options:

DF indicates Double Hung/Fixed
FD indicates Fixed/Double Hung
DD indicates Double Hung/Double Hung
DFD indicates Double Hung/Fixed/Double Hung

































































DDD indicates Double Hung/Double Hung/Double Hung
F indicates Fixed
T after the size indicates a Transom

General:

Black hardware is supplied as standard

* Refer to Special Products on page 129 for Bar Layout Options

standard double hung

STUD OPENING WINDOW	656	780	899	1131	1484	1722	2186	2545
	600	724	843	1075	1428	1666	2130	2489
989	 ATD0906	 ATD0907	 ATD0909	 ATD0911	 ATDF0914	 ATDF0917	 ATDFD0921	 ATDFD0925
1076	 ATD1006	 ATD1007	 ATD1009	 ATD1011	 ATDF1014	 ATDF1017	 ATDFD1021	 ATDFD1025
1247	 ATD1206	 ATD1207	 ATD1209	 ATD1211	 ATDF1214	 ATDF1217	 ATDFD1221	 ATDFD1225
1418	 ATD1406	 ATD1407	 ATD1409	 ATD1411	 ATDF1414	 ATDF1417	 ATDFD1421	 ATDFD1425
1590	 ATD1506	 ATD1507	 ATD1509	 ATD1511	 ATDF1514	 ATDF1517	 ATDFD1521	 ATDFD1525
1856	 ATD1806	 ATD1807	 ATD1809	 ATD1811	 ATDF1814	 ATDF1817	 ATDFD1821	 ATDFD1825
2098	 ATD2006	 ATD2007	 ATD2009	 ATD2011	 ATDF2014	 ATDF2017	 ATDFD2021	 ATDFD2025
2098	 ATD2006T	 ATD2007T	 ATD2009T	 ATD2011T	 ATDF2014T	 ATDF2017T	 ATDFD2021T	 ATDFD2025T

ordering details

All windows are illustrated as viewed from outside. Codes shown are for plain windows. Manufactured from 64mm aluminium extrusion. The first two numbers of code indicate approximate height, the last two numbers indicate approximate width.

Sash Style Options:

Standard option is:
Eg window code ATD0906

Bar Options:

CL indicates Colonial Bar.
Eg window code ATD0906CL
FED indicates Federation Bar.
Eg window code ATD0906FED

Configuration Options:

DF indicates Double Hung/Fixed
FD indicates Fixed/Double Hung
DD indicates Double Hung/Double Hung
DFD indicates Double Hung/Fixed/Double Hung

DDD indicates Double Hung/Double Hung/Double Hung
F indicates Fixed
T after the size indicates a Transom

General:

Black hardware is supplied as standard

* Refer to Special Products on page 129 for Bar Layout Options

QLD - features & benefits

- 1 Energy Efficiency Options
Trend® Thermashield® in various glazing styles are available to help reduce energy consumption. Trend® Thermashield® means greater control, bigger savings and most importantly one less thing to worry about. Energy efficient options to u-value of 3.6 and SHGC 0.33 are available for Trend® Double Hung window.
- 2 Acoustic Options
SoundMizer® acoustic solutions in various STC ratings, are available to STC 31 for Trend® Double Hung window. SoundMizer® acoustic solutions can reduce aircraft, highway traffic, railway and other annoying noise problems. For information or technical details contact Trend®.
- 3 Key locks
All Trend® Wide Style Double Hung Windows are available with optional key lock that can be keyed to match other Trend® aluminium windows. Vent locks are available for Trend® Double Hung Windows.
- 4 Complementary Accessories
 - 180° non-load bearing couplers, two types for added mullion strength when required.
 - 135° & 90° non-load-bearing corner couplers to suit bay and kitchen windows.
 - 66mm and 100mm aluminium architraves for replacement window installations.
 - Adjustable aluminium storm mould.
 - Extruded aluminium 180° and 90° mullion covers to hide load-bearing posts.
- 5 Interlocking Meeting Rails
The interlocking meeting rails on the sashes combine together when closed to improve the overall weather performance strength. The sashes by-pass to facilitate easy internal glass cleaning.
6. Weather Sealed for Full Protection
All sashes are fitted with weatherpile seals to keep the dust and water where they belong, on the outside.
- 7 Options
Colonial Bar and Federation Bar Layouts are available. Easy to fit flyscreens. Wide range of powdercoat finishes.

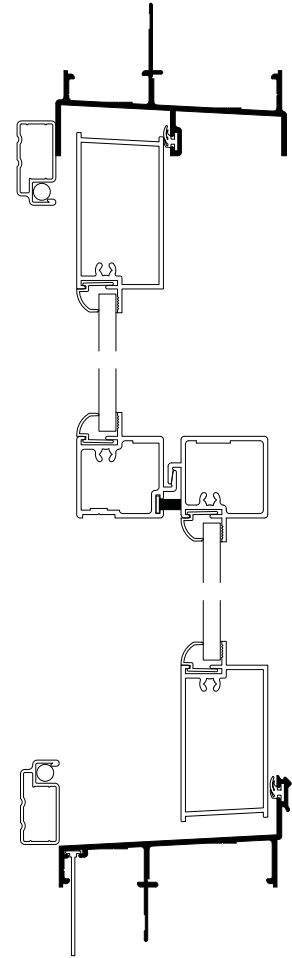

ordering details

All windows are illustrated as viewed from outside. Codes shown are for plain windows Manufactured from 64mm aluminium extrusion The first two numbers of code indicate approximate height, the last two numbers indicate approximate width.

Sash Style Options:

Standard option is:
Eg window code QWD0906/1
O indicates Ovolo D/Hung sash with Ovolo Glazing Bar. Eg window code QOWD0906/1CL

T indicates Thermashield® double glazed sash style. Eg window code QTWD0906/1
* Double Glazing not available with ovolo bar.

Bar Options:

CL indicates Colonial Bar.
Eg window code QWD0906/1CL
FED indicates Federation Bar.
Eg window code QWD0906/1FED

Configuration Options:

/1 indicates one pair of sashes
/2 indicates two pair of sashes

/3 indicated three pair of sashes
X after the size indicates a Transom

General:

































































Black hardware is supplied as standard

Note:

No sill reveal to 2100 high windows

* Refer to Special Products on page 129 for Bar Layout Options

QLD - wide style double hung

STUD OPENING WINDOW	660	960	1260	1560	1860	2160	2460	2760
	610	910	1210	1510	1810	2110	2410	2710
955								
1055								
1255								
1420								
1555								
1855								
2135								
2135 +900 +1200								

QLD ONLY

QLD - designer double hung

		660	960	1260	1560	1860	2160	2460	2760
		610	910	1210	1510	1810	2110	2410	2710
STUD OPENING WINDOW	955								
	1055								
	1255								
	1420								
	1555								
	1855								
	2135								
	2135								
		900							
		1000							
	1200								
	1365								
	1500								
	1800								
	2100								
	2100								

ordering details

All windows are illustrated as viewed from outside. Codes shown are for plain windows. Manufactured from 64mm aluminium extrusion. The first two numbers of code indicate approximate height, the last two numbers indicate approximate width.

Sash Style Options:

Standard option is:
Eg window code QOD0906/1
O indicates Ovolo D/Hung sash with Ovolo Glazing Bar. Eg window code QOD0906/1

Bar Options:

CL indicates Colonial Bar.
Eg window code QOD0906CL
FED indicates Federation Bar.
Eg window code QOD0906FED

Configuration Options:

/1 indicates one pair of sashes
/2 indicates two pair of sashes
/3 indicated three pair of sashes
X after the size indicates a Transom
F indicates Fixed

General:

































































Black hardware is supplied as standard

Note:

No sill reveal to 2100 high windows

* Refer to Special Products on page 129 for Bar Layout Options

QLD - standard double hung

STUD OPENING WINDOW		660	960	1260	1560	1860	2160	2460	2760
		610	910	1210	1510	1810	2110	2410	2710
955	900								
1055	1000								
1255	1200								
1420	1365								
1555	1500								
1855	1800								
2135	2100								
2135	2100								

ordering details

All windows are illustrated as viewed from outside. Codes shown are for plain windows. Manufactured from 64mm aluminium extrusion. The first two numbers of code indicate approximate height, the last two numbers indicate approximate width.

Sash Style Options:

Standard option is:
Eg window code QD0906

Bar Options:

CL indicates Colonial Bar.
Eg window code QD0906CL
FED indicates Federation Bar.
Eg window code QD0906FED

Configuration Options:

/1 indicates one pair of sashes
/2 indicates two pair of sashes
/3 indicated three pair of sashes

X after the size indicates a Transom
F indicates Fixed

General:

Black hardware is supplied as standard

Note:

No sill reveal to 2100 high windows

* Refer to Special Products on page 129 for Bar Layout Options

awning windows



light and easy

Trend® Awning windows epitomise the easy living Australian way of life. Maximising space and light with contemporary, clean designs.

Awning windows are great for creating a sense of size, letting you create a broad expanse of glass that makes the most of natural surroundings.

For a more classic look consider the Ovolo round sash bar profile – it's perfect for traditional style homes.

On a practical level, the optional high quality stainless steel chain winder stop windows slamming, while the hood protects against the elements.

features & benefits

- 1 Energy Efficiency Options
Trend® Thermashield® in various glazing styles are available to help reduce energy consumption. Trend® Thermashield® means greater control, bigger savings and most importantly one less thing to worry about. Energy efficient options to u-value of 3.5 and SHGC 0.39 are available for Trend® Awning window.
- 2 Acoustic Options
SoundMizer® acoustic solutions in various STC ratings, are available to STC 39 for Trend® Awning window. SoundMizer® acoustic solutions can reduce aircraft, highway traffic, railway and other annoying noise problems. For information or technical details contact Trend®.
- 3 Optional Key Lock Chain Winder
Trend® Awning Window winder mechanism is designed specifically for high performance, security and reliability. With a Polesium™ cover and base combined with a stainless steel chain as standard for long life and reliability, the winder can be used in even the harshest environment without the worry of corrosion. The robust mechanisms are mounted securely to the window with a concealed 2 point fixing. Keyed lock is standard for added security.
- 4 Continuous Hinge Hood
The sash is protected from the weather by a continuous hinge hood that supports the sash and keeps the rain where it belongs - on the outside.
- 5 Weather Protection
The tubular splayed sash, with self-draining trough, assists the continuous surround bulb seal to protect against even the most adverse weather conditions.
- 6 Sash Corner Protection
The bottom rail sash corners are protected by a custom nylon cover that acts as a sash guide into the frame.
- 7 Glazing
Trend® sash is available in special laminates for energy efficiency applications. Acoustic solutions are also available to high STC ratings.
- 8 Complementary Accessories
 - 180° non-load bearing couplers, two types available for added mullion strength when required.
 - 135° & 90° non-load-bearing corner couplers to suit bay and kitchen windows.
 - 100mm aluminium architraves for replacement window installations.
 - Adjustable aluminium storm mould.
 - Aluminium 180° and 90° mullion covers to hide load-bearing posts.
- 9 Options
Easy to fit tension loaded flyscreens can be fitted and removed from the inside. Wide range of powdercoat finishes available.

NOTE:

Window Placement
Care should be taken with locating opening awning windows in pedestrian traffic areas.

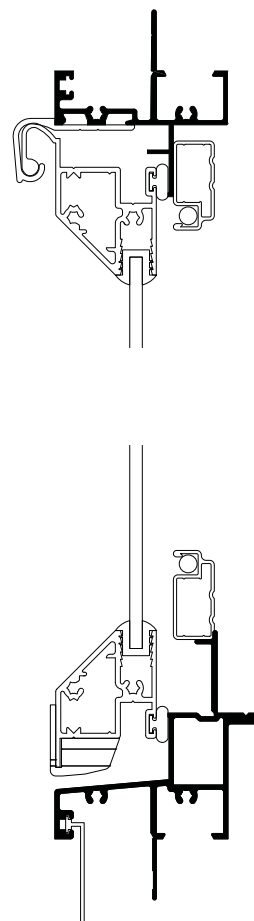

ordering details

All windows are illustrated as viewed from outside. Codes shown are for plain windows. Manufactured from 48mm aluminium extrusion. The first two numbers of code indicate approximate height, the last two numbers indicate approximate width.

Sash Style Options:

Standard option is:
Eg window code AA0606
T indicates Thermashield® double glazed sash style. Eg window code ATA0606
N indicates Sentinel sash style.
Eg window code ANA0606

M indicates Acoustic sash style (SoundMizer®)
Eg window code AMA0606

Bar Options:

CL indicates Colonial Bar.
Eg window code AA0606CL
FD indicates Federation Bar.
Eg window code AA0606FD

Configuration Options:

A indicates Awning
F indicates Fixed
AA indicates Awning\Awning
AF indicates Awning\Fixed











































































FA indicates Fixed\Awning
FF indicates Fixed\Fixed
AAA indicates Awning\Awning\Awning
AFA indicates Awning\Fixed\Awning
FAF indicates Fixed\Awning\Fixed
FFF indicates Fixed\Fixed\Fixed
T after the size indicates a Transom

General:

Black hardware is supplied as standard

* Refer to Special Products on page 129 for Bar Layout Options

awning windows

		656	780	899	1018	1258	1506	1847	2232	2589
STUD OPENING		600	724	843	962	1202	1450	1791	2176	2533
WINDOW	646									
	590									
	732									
	676									
	989									
	933									
	1076									
	1020									
	1247									
	1191									
	1418									
	1362									
	1856									
1800										
2098										
2042										
2098										
2042										

QLD - features & benefits

- 1 Energy Efficiency Options
Trend® Thermashield® in various glazing styles are available to help reduce energy consumption. Trend® Thermashield® means greater control, bigger savings and most importantly one less thing to worry about. Energy efficient options to u-value of 3.5 and SHGC 0.39 are available for Trend® Awning window.
- 2 Acoustic Options
SoundMizer® acoustic solutions in various STC ratings, are available to STC 39 for Trend® Awning window. SoundMizer® acoustic solutions can reduce aircraft, highway traffic, railway and other annoying noise problems. For information or technical details contact Trend®.
- 3 Optional Key Lock Chain Winder
Trend® Awning Window winder mechanism is designed specifically for high performance, security and reliability. With a Polesium™ cover and base combined with a stainless steel chain as standard for long life and reliability, the winder can be used in even the harshest environment without the worry of corrosion. The robust mechanisms are mounted securely to the window with a concealed 2 point fixing.

Trend® Awning Windows can be fitted with an optional key lock chain winder.
- 4 Continuous Hinge Hood
The sash is protected from the weather by a continuous hinge hood that supports the sash and keeps the rain where it belongs - on the outside.
- 5 Weather Protection
The tubular splayed sash, with self-draining trough, assists the continuous surround bulb seal to protect against even the most adverse weather conditions.
- 6 Sash Corner Protection
The bottom rail sash corners are protected by a custom nylon cover that acts as a sash guide into the frame.
- 7 Glazing
Trend® sash is available in special laminates for energy efficiency applications. Acoustic solutions are also available to high STC ratings.
- 8 Complementary Accessories
 - 180° non-load bearing couplers, two types for added mullion strength when required.
 - 135° & 90° non-load bearing corner couplers to suit bay and kitchen windows.
 - 66mm and 100mm aluminium architraves for replacement window installations.
 - Adjustable aluminium storm mould.
 - Extruded aluminium 180° & 90° mullion covers to hide load-bearing posts.
- 9 Options
Easy to fit tension loaded flyscreens can be fitted and removed from the inside. Wide range of powdercoat finishes available.

NOTE:

Window Placement
Care should be taken with locating opening awning windows in pedestrian traffic areas.

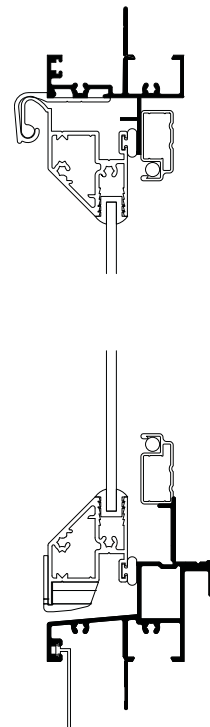

ordering details

All windows are illustrated as viewed from outside. Codes shown are for plain windows Manufactured from 48mm aluminium extrusion. The first two numbers of code indicate approximate height, the last two numbers indicate approximate width.

Sash Style Options:

Standard option is:
Eg window code QA0606
O indicates Ovolo sash style with Ovolo Glazing Bar. Eg window code QOA0606CL
T indicates Thermashield® double glazed sash style. Eg window code QTA0606
N indicates Sentinel sash style.
Eg window code QNA0606

M indicates Acoustic sash style (SoundMizer®)
Eg window code QMA0606

Bar Options:

CL indicates Colonial Bar.
Eg window code QA0606CL
FD indicates Federation Bar.
Eg window code QA0606FD

Configuration Options:

A indicates Awning
F indicates Fixed
AA indicates Awning\Awning
AF indicates Awning\Fixed
FA indicates Fixed\Awning
FF indicates Fixed\Fixed

AAA indicates Awning\Awning\Awning
AFA indicates Awning\Fixed\Awning
FAF indicates Fixed\Awning\Fixed
FFF indicates Fixed\Fixed\Fixed
X after the size indicates a Transom

General:

































































Black hardware is supplied as standard

Note:

No sill reveal to 2100 high windows

* Refer to Special Products on page 129 for Bar Layout Options

QLD - awning windows

STUD OPENING WINDOW		660	960	1260	1560	1860	2160	2460	2760
		610	910	1210	1510	1810	2110	2410	2710
655	600								
		QA0606	QA0609	QA0612	QA0615	QA0618	QA0621	QA0624	QA0627
955	900								
		QA0906	QA0909	QA0912	QA0915	QA0918	QA0921	QA0924	QA0927
1055	1000								
		QA1006	QA1009	QA1012	QA1015	QA1018	QA1021	QA1024	QA1027
1255	1200								
		QA1206	QA1209	QA1212	QA1215	QA1218	QA1221	QA1224	QA1227
1420	1365								
		QA1406	QA1409	QA1412	QA1415	QA1418	QA1421	QA1424	QA1427
1855	1800								
		QA1806X	QA1809X	QA1812X	QA1815X	QA1818X	QA1821X	QA1824X	QA1827X
2135	2100								
		QA2106X	QA2109X	QA2112X	QA2115X	QA2118X	QA2121X	QA2124X	QA2127X
2135	2100								
		QA2106	QA2109	QA2112	QA2115	QA2118	QA2121	QA2124	QA2127

QLD ONLY

casement windows



refresh your view

Trend[®] casement windows are a classic design, bringing character and romance to any home.

Their strong angular lines overcome that boxy feeling and are great at capturing cooling summer breezes.

Our durable, lever operated cam catch ensures everything closes securely and you can also order specially designed fly screens.

On a practical level the outside of each window can easily be cleaned from the inside with a full ninety degree opening.

For areas other than Queensland please refer to Quantum Casement on page 74

QLD - features & benefits

- 1 Energy Efficiency Options
Trend® Thermashield® in various glazing styles are available to help reduce energy consumption. Trend® Thermashield® means greater control, bigger savings and most importantly one less thing to worry about. Energy efficient options to u-value of 3.5 and SHGC 0.39 are available for Casement window.
- 2 Acoustic Options
SoundMizer® acoustic solutions in various STC ratings, are available to STC 39 for Casement window. SoundMizer® acoustic solutions can reduce aircraft, highway traffic, railway and other annoying noise problems.
For information or technical details contact Trend®.
- 3 Trend® Aluminium Casement windows carries standard casement hardware.
- 4 Sashes are fitted with stainless steel stays which allow the sash to move away from the window jamb, making it possible to clean the outside face of the glass from within the building.
- 5 The sash perimeter is fitted with a PVC bulb seal ensuring a full weather tight seal against the elements. (Ideal for thermal or sound control).
- 6 Complementary Accessories
 - 180° non-load-bearing couplers, two types for added mullion strength when required.
 - 135° & 90° non-load-bearing corner couplers to suit bay and kitchen windows.
 - 66mm and 100mm aluminium architraves for replacement window installations.
 - Adjustable aluminium storm mould.
 - Extruded aluminium 180° mullion covers to hide load-bearing posts.

NOTE:

Window Placement
Care should be taken with locating opening awning windows in pedestrian traffic areas.

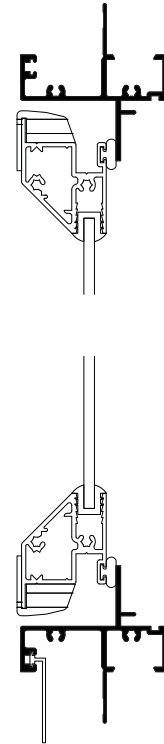

ordering details

All windows are illustrated as viewed from outside. Codes shown are for plain windows. Manufactured from 48mm aluminium extrusion. The first two numbers of code indicate approximate height, the last two numbers indicate approximate width.

Sash Style Options:

Standard option is:
Eg window code QC0906
T indicates Thermashield® double glazed sash style. Eg window code QTC0906

Bar Options:

CL indicates Colonial Bar.
Eg window code QC0906CL
FD indicates Federation Bar.
Eg window code QC0906FD

Configuration Options:

L indicates Left Hand Hinge
R indicates Right Hand Hinge
F indicates Fixed
LL indicates Left Hand\Left Hand
LR indicates Left Hand\Right Hand
LF indicates Left Hand\Fixed
RR indicates Right Hand\Right Hand
FR indicates Fixed\Right Hand
FF indicates Fixed\Fixed
LFR indicates Left Hand\Fixed\Right Hand
LLL indicates Left Hand\Left Hand\Left Hand
RRR indicates Right Hand\Right Hand\Right Hand
FLF indicates Fixed\Left Hand\Fixed
FRF indicates Fixed\Right Hand\Fixed
LRR indicates Left Hand\Right Hand\Right Hand





























LLR indicates Left Hand\Left Hand\Right Hand
FFF indicates Fixed\Fixed\Fixed
X after the size indicates a Transom

Note:

No sill reveal to 2100 high windows

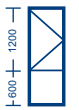
* Refer to Special Products on page 129 for Bar Layout Options

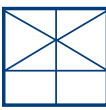
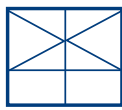
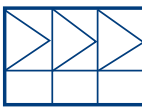
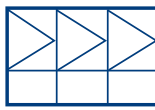
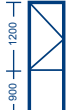
QLD - casement windows

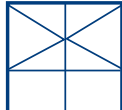
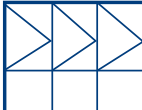
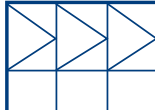
STUD OPENING WINDOW		660	960	1260	1560	1860	2160
		610	910	1210	1510	1810	2110
955	900	 QC0906	 QC0909	 QC0912	 QC0915	 QC0918	 QC0921
1055	1000	 QC1006	 QC1009	 QC1012	 QC1015	 QC1018	 QC1021
1255	1200	 QC1206	 QC1209	 QC1212	 QC1215	 QC1218	 QC1221
1420	1365	 QC1406	 QC1409	 QC1412	 QC1415	 QC1418	 QC1421
1855	1800	 QC1806X	 QC1809X	 QC1812X	 QC1815X	 QC1818X	 QC1821X
2135	2100	 QC2106X	 QC2109X	 QC2112X	 QC2115X	 QC2118X	 QC2121X

sliding window



smooth living

Trend® sliding windows are perfect for capturing that special view or garden outlook.

They create a clean uncluttered look that opens the room up so you can enjoy that indoor - outdoor feeling that makes the most of warm summer evenings or winter sun.

The extra durable rollers ensure the aluminium frames always glide smooth and true.

While optional ventilation key locks allow you to lock the windows partially open to catch cooling breezes.

features & benefits

- 1 Energy Efficiency Options
Trend® Thermashield® in various glazing styles are available to help reduce energy consumption. Trend® Thermashield® means greater control, bigger savings and most importantly one less thing to worry about. Energy efficient options to u-value of 3.5 and SHGC 0.42 are available for Trend® Sliding Window.
- 2 Acoustic Options
SoundMizer® acoustic solutions in various STC ratings, are available to STC 36 for Trend® Sliding Window. SoundMizer® acoustic solutions can reduce aircraft, highway traffic, railway and other annoying noise problems.
For information or technical details contact Trend®.
- 3 Key Locks
Trend® Sliding windows are available with the award winning key lock cam handle as standard or with optional Trend® ventlock.
- 4 Complementary Accessories
 - 180° non-load bearing couplers, two types available for added mullion strength when required.
 - 135° & 90° non-load-bearing corner couplers to suit bay and kitchen windows.
 - 100mm aluminium architraves for replacement window installations.
 - Adjustable aluminium storm mould.
 - Extruded aluminium 180° and 90° mullion covers to hide load-bearing posts.
- 5 Removable Fixed Sash
The fixed sash on sliding windows is removable to enable windows to be re-handled on site. Additionally, if the window is broken in the future, it is possible to remove the sash and be taken to a glazier for repair, thereby saving an expensive site visit.
- 6 Glazing
Sash glass is protected by a full wrap-around glazing channel. As the window can be re-glazed from inside the building, there is no need for expensive scaffolding if you break the glass on a Trend® Sliding Window. Double Glazing is available for energy efficiency requirements.
- 7 Sill Baffle
The Trend® Sliding Window has an external full width sill baffle covering drainage outlets, thereby reducing infiltration of dust and drafts.
- 8 Sash Rollers
Sash rollers are height adjustable and sashes glide effortlessly on graphite impregnated rollers. Also available double bogey adjustable roller for heavy sashes or double glazing.
- 9 Weathershield Fin
The weathershield fin prevents metal to metal contact in the operation of sliding sashes, resulting in a reduction of air and dust penetration.
- 10 Options
Colonial Bar and Federation Bar Layouts are available.
Easy to fit flyscreens.
Wide range of powdercoat finishes.

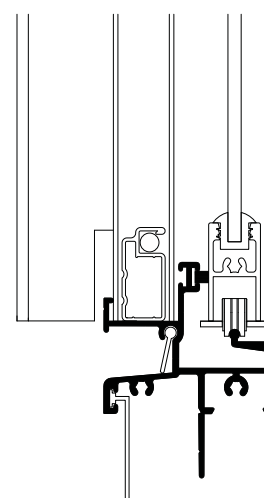
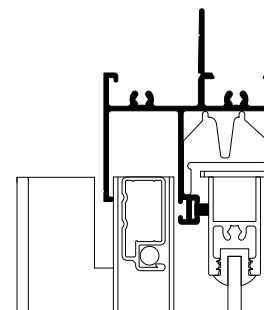

ordering details

All windows are illustrated as viewed from outside. Codes shown are for plain windows. Manufactured from 48mm aluminium extrusion. The first two numbers of code indicate approximate height, the last two numbers indicate approximate width.

Sash Style Options:

Standard option is:
Eg window code AS0906
T indicates Thermashield® double glazed sash style. Eg window code ATS0906
M indicates Acoustic sash style (SoundMizer®)

Eg window code AMS0906
S indicates Sump Sill.
Eg window code ASS0906

Bar Options:

CL indicates Colonial Bar.
Eg window code AS0906CL
FD indicates Federation Bar.
Eg window code AS0906FD

















































































Configuration Options:

SF indicates Sliding/Fixed
FS indicates Fixed/Sliding
SFS indicates Sliding/Fixed/Sliding

FSF indicates Fixed/Sliding/Fixed
F indicates Fixed
T after the size indicates a Transom

* Refer to Special Products on page 129 for Bar Layout Options

sliding windows

STUD OPENING WINDOW		656	780	899	1256	1494	1606	1847	2209	2447	2685
		600	724	843	1200	1438	1550	1791	2153	2391	2629
646	590										
989	933										
1076	1020										
1247	1191										
1418	1362										
1590	1534										
1856	1800										
2098	2042										

QLD - features & benefits

- 1 Energy Efficiency Options
Trend® Thermashield® in various glazing styles are available to help reduce energy consumption. Trend® Thermashield® means greater control, bigger savings and most importantly one less thing to worry about. Energy efficient options to u-value of 3.5 and SHGC 0.42 are available for Trend® Sliding Window.
- 2 Acoustic Options
SoundMizer® acoustic solutions in various STC ratings, are available to STC 36 for Trend® Sliding Window. SoundMizer® acoustic solutions can reduce aircraft, highway traffic, railway and other annoying noise problems.
For information or technical details contact Trend®.
- 3 Key Locks
Trend® Sliding windows are available with the award winning key lock cam handle as standard or with optional Trend® ventlock.
- 4 Complementary Accessories
 - 180° non-load-bearing couplers, two types for added mullion strength when required.
 - 135° & 90° non-load-bearing corner couplers to suit bay and kitchen windows.
 - 66mm and 100mm aluminium architraves for replacement window installations.
 - Adjustable aluminium storm mould.
 - Extruded aluminium 180° mullion covers to hide load-bearing posts.
- 5 Removable Fixed Sash
The fixed sash on sliding windows is removable to enable windows to be re-handled on site. Additionally, if the window is broken in the future, it is possible to remove the sash and be taken to a glazier for repair, thereby saving an expensive site visit.
- 6 Glazing
Sash glass is protected by a full wrap-around glazing channel. As the window can be re-glazed from inside the building, there is no need for expensive scaffolding if you break the glass on a Trend® Sliding Window. Double Glazing is available for energy efficiency requirements.
- 7 Sill Baffle
The Trend® Sliding Window has an external full width sill baffle covering drainage outlets, thereby reducing infiltration of dust and drafts.
- 8 Sash Rollers
Sash rollers are height adjustable and sashes glide effortlessly on graphite impregnated rollers. Also available double bogey adjustable roller for heavy sashes or double glazing.
- 9 Weathershield Fin
The weathershield fin prevents metal to metal contact in the operation of sliding sashes, resulting in a reduction of air and dust penetration.
- 10 Options
Colonial Bar and Federation Bar Layouts are available.
Easy to fit flyscreens.
Wide range of powdercoat finishes.

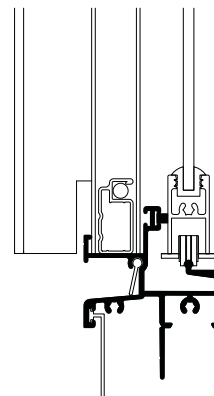
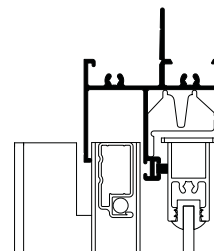

ordering details

All windows are illustrated as viewed from outside. Codes shown are for plain windows Manufactured from 48mm aluminium extrusion. The first two numbers of code indicate approximate height, the last two numbers indicate approximate width.

Sash Style Options:

Standard option is:
Eg window code QS0906
T indicates Thermashield® double glazed sash style. Eg window code QTS0906
M indicates Acoustic sash style (SoundMizer®).

Eg window code QMS0906
S indicates Sump Sill.
Eg window code QSS0906

Bar Options:

CL indicates Colonial Bar.
Eg window code QS0906CL
FD indicates Federation Bar.
Eg window code QS0906FD

Configuration Options:

SF indicates Sliding/Fixed
FS indicates Fixed/Sliding
SFS indicates Sliding/Fixed/Sliding

FSF indicates Fixed/Sliding/Fixed
F indicates Fixed
X after the size indicates a Transom

Note:

No sill reveal to 2100 high window.

* Refer to Special Products on page 129 for Bar Layout Options

QLD - sliding windows

STUD OPENING WINDOW	660	960	1260	1560	1860	2160	2460	2760	3060
	610	910	1210	1510	1810	2110	2410	2710	3010
655									
955									
1055									
1255									
1420									
1555									
1855									
2135									

QLD ONLY

bifold windows



let the outside in

Trend[®] Bifold windows let you fold the outside into any room.

Light and space flow in as your windows simply fold away.

Always a favourite when space is at premium. They can be custom designed to your taste and style.

While stainless steel hardware ensures lasting good looks and durability.

features & benefits

- 1 Energy Efficiency Options
Trend® Thermashield® in various glazing styles are available to help reduce energy consumption. Trend® Thermashield® means greater control, bigger savings and most importantly one less thing to worry about. Energy efficient options to u-value of 3.4 and SHGC 0.36 are available for Trend® Bifold window.
- 2 Acoustic Options
SoundMizer® acoustic solutions in various STC ratings, are available to STC 35 for Trend® Bifold window. SoundMizer® acoustic solutions can reduce aircraft, highway traffic, railway and other annoying noise problems. For information or technical details contact Trend®.
- 3 Window Hardware
Stainless steel hardware is provided as standard. Window hardware, hinges and drop bolts are available in four finishes, stainless steel, gold, white and black powder coat.
- 4 Frames
The weight of the bifold windows must be considered in the structural beam calculation of the overall structure. The bifold window and frame are not structural elements and the head of the frame should be attached to the structural beam.

Minimum Frame Height is 1000mm
Maximum Frame Height is 2400mm
Maximum Frame Width is 6062mm
Maximum Window Leaf Size is 870mm
Maximum Weight in one direction is 180kg
- 5 Protective Wrapping
Protective wrapping for delivery to site is an option for all Trend® products.
- 6 Options
Wide range of powdercoat finishes including Timber finishes available.

NOTE: Available open out only.

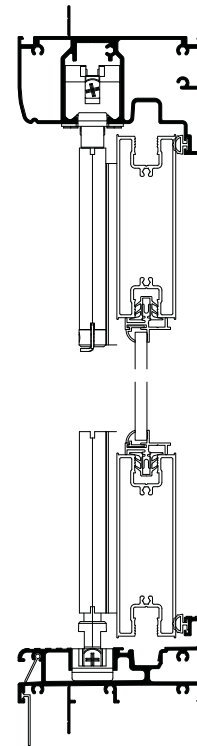

ordering details

All windows are illustrated as viewed from outside. Codes are for plain windows.

Sash Style Options:

The first two numbers of code indicate approximate height, the last two numbers indicate approximate width.

Standard option is:

Eg window code ABF2214/2L

O indicates ovolo sash style.

Eg window code AOBF2214/2LCL

T indicates Thermashield® double glazed sash style. Eg window code ATBF2214/2L

M indicates Acoustic sash style (SoundMizer®)

Eg window code AMBF2214/2L

Bar Options:

CL indicates Colonial Bar.

Eg window code ABF2214/2LCL

FED indicates Federation Bar.

Eg window code ABF2214/2LFED

Configuration Options:

Configuration is shown at the end of the code

Eg window code ABF2220/1L2R (1Left, 2Right)

Note:

The weight of the bifold windows must be considered in the structural beam calculation of the overall structure. The bifold door/

window and frame are not structural elements and the head of the frame should be attached to the structural beam.

Available open out only.

Minimum frame height 1000.

Maximum frame height 2400.













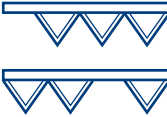
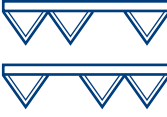















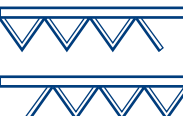

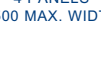
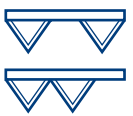

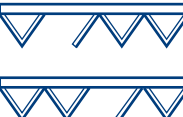
Max door / window leaf size 870.

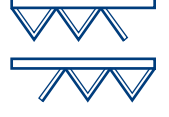
Max weight in one direction 180kg.

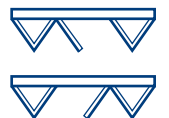
Max width is 6.065 metres.

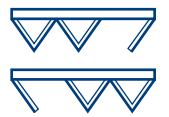
* Refer to Special Products on page 129 for Bar Layout Options

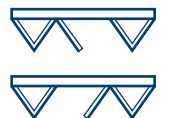
bifold window system

STUD OPENING		FRAME WIDTH + 56mm					
WINDOW	Max Width		Leaf #		Max Width	Leaf #	
 2 PANELS 1800 MAX. WIDTH	1800		2L 2R		5300	 6L  6R  4L 2R  2L 4R	
 3 PANELS 2700 MAX. WIDTH	2700	 	3R 3L	 6 PANELS 5300 MAX. WIDTH		 3L 3R	
 3 PANELS 2700 MAX. WIDTH	2700	 	2L 1R 1L 2R			 5L 1R  1L 5R	
 4 PANELS 3500 MAX. WIDTH	3500	 	3L 1R 1L 3R		 7 PANELS 6065 MAX. WIDTH	 7L  7R	
 4 PANELS 3500 MAX. WIDTH	3500	 	2L 2R 4L 4R	 5L 2R 2L 5R  4L 3R  3L 4R			
 5 PANELS 4400 MAX. WIDTH	4400	 	5L 5R	 3L 2R  2L 3R			
 5 PANELS 4400 MAX. WIDTH	4400	 	4L 1R 1L 4R		6065		
 5 PANELS 4400 MAX. WIDTH	4400	 	3L 2R 2L 3R		6065		

Note: Refer to Trend Windows & Doors Sales for Bifold Window Product Codes

bay windows



bay with a view

A bay window adds distinctive charm and character to bedrooms or living areas, helping make the most of views - creating sun filled reading nooks for winter or cool shady relaxing spaces in summer.

An individual touch that sets your house apart from the crowd.

With this in mind, you can design your bay window around any combination of Trend® windows.

It's your home - the choice is up to you.

standard double hung bay windows

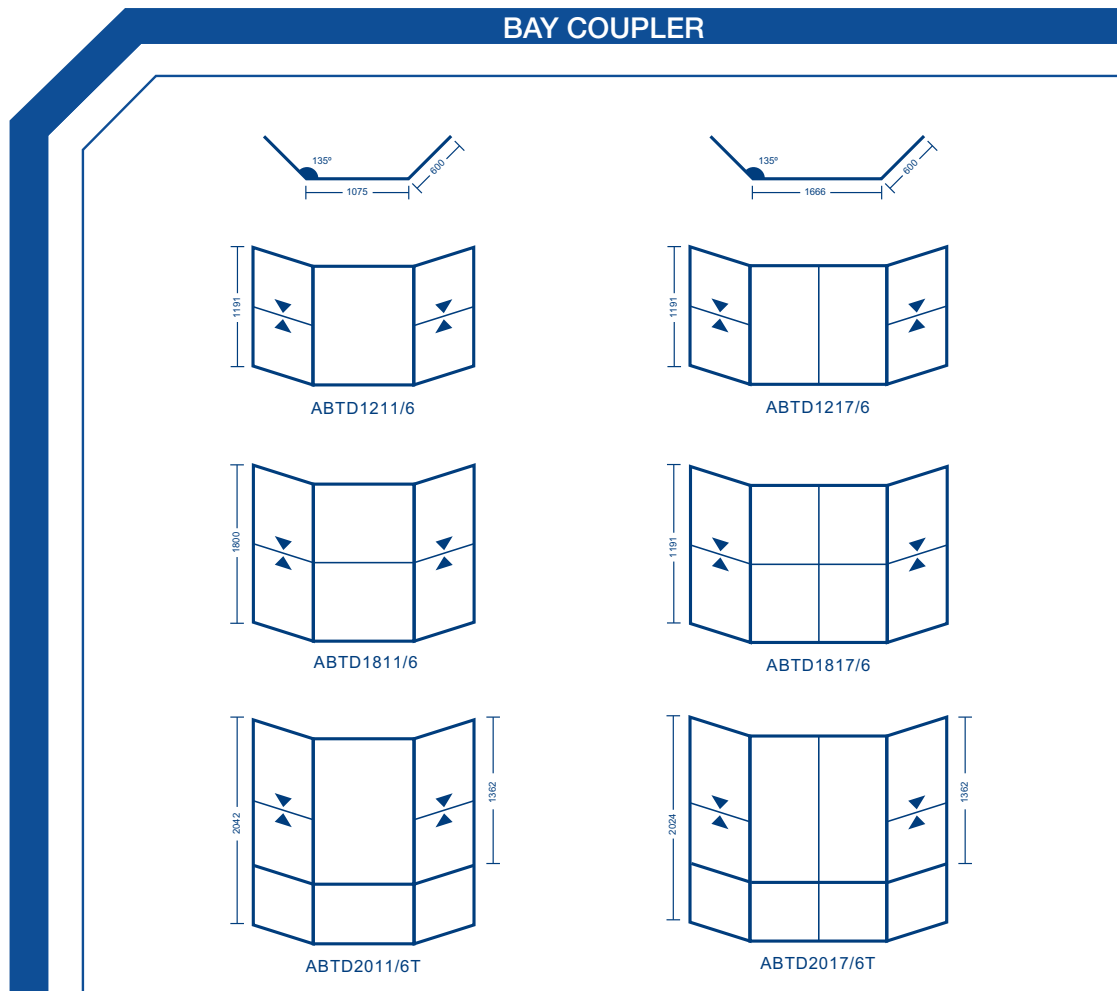

ordering details

All windows are illustrated as viewed from outside. Codes shown are for plain windows. Manufactured from 64mm aluminium extrusion. The first two numbers of code indicate approximate height. The last two numbers of code indicate approximate centre size of bay window.

For Colonial bar layout place CL at the end of the code. For Federation bar layout place FED at the end of the code. ABOD indicates Aluminium Ovolo Bay Double Hung.

T after the size indicates a Transom.
/6 indicates 600mm wings.
/7 indicates 724mm wing option.

Note:

The illustration above is a representative range of bay windows. Bays can be manufactured to all standard heights and widths. Other options include keyed locking catches, aluminium flyscreens, custom built frames to your design.

* Refer to Special Products on page 129 for Bar Layout Options

bay window diagrams

A090 Bay Coupler. Suits all 48mm windows

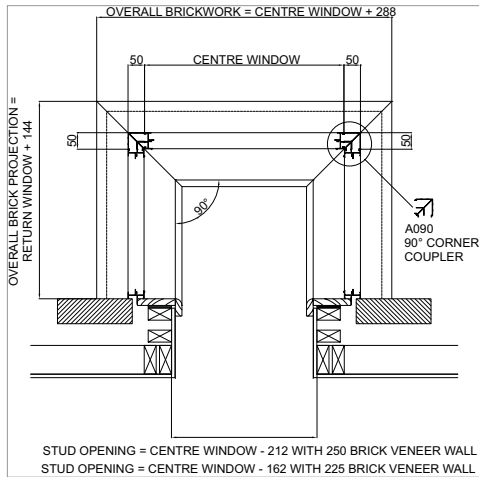

A473/A474 Bay Coupler. Suits all 48mm & 64mm windows

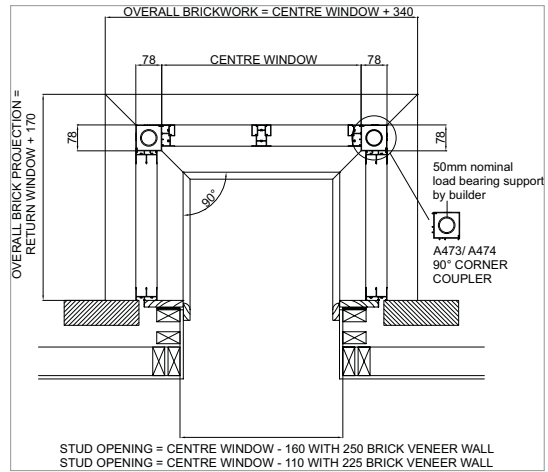

A475 Bay Coupler. Suits all 64mm windows

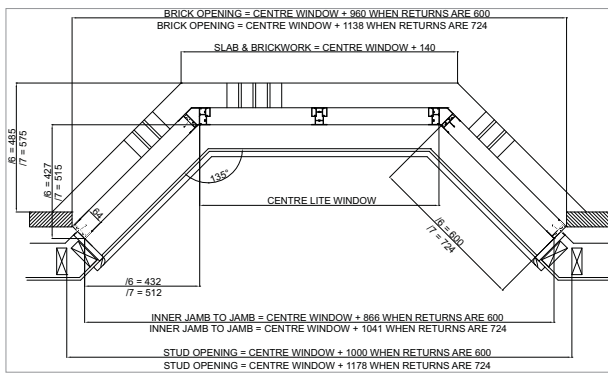

A021 Bay Coupler. Suits all 48mm windows

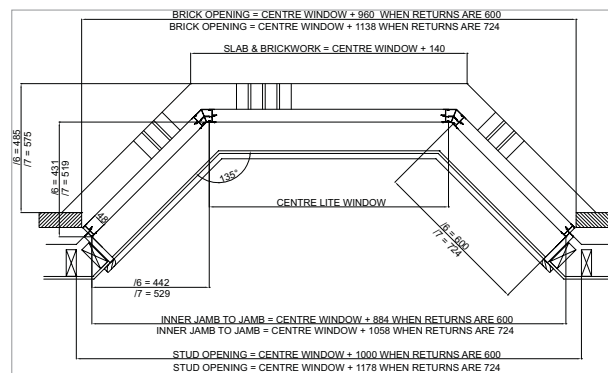

louvres

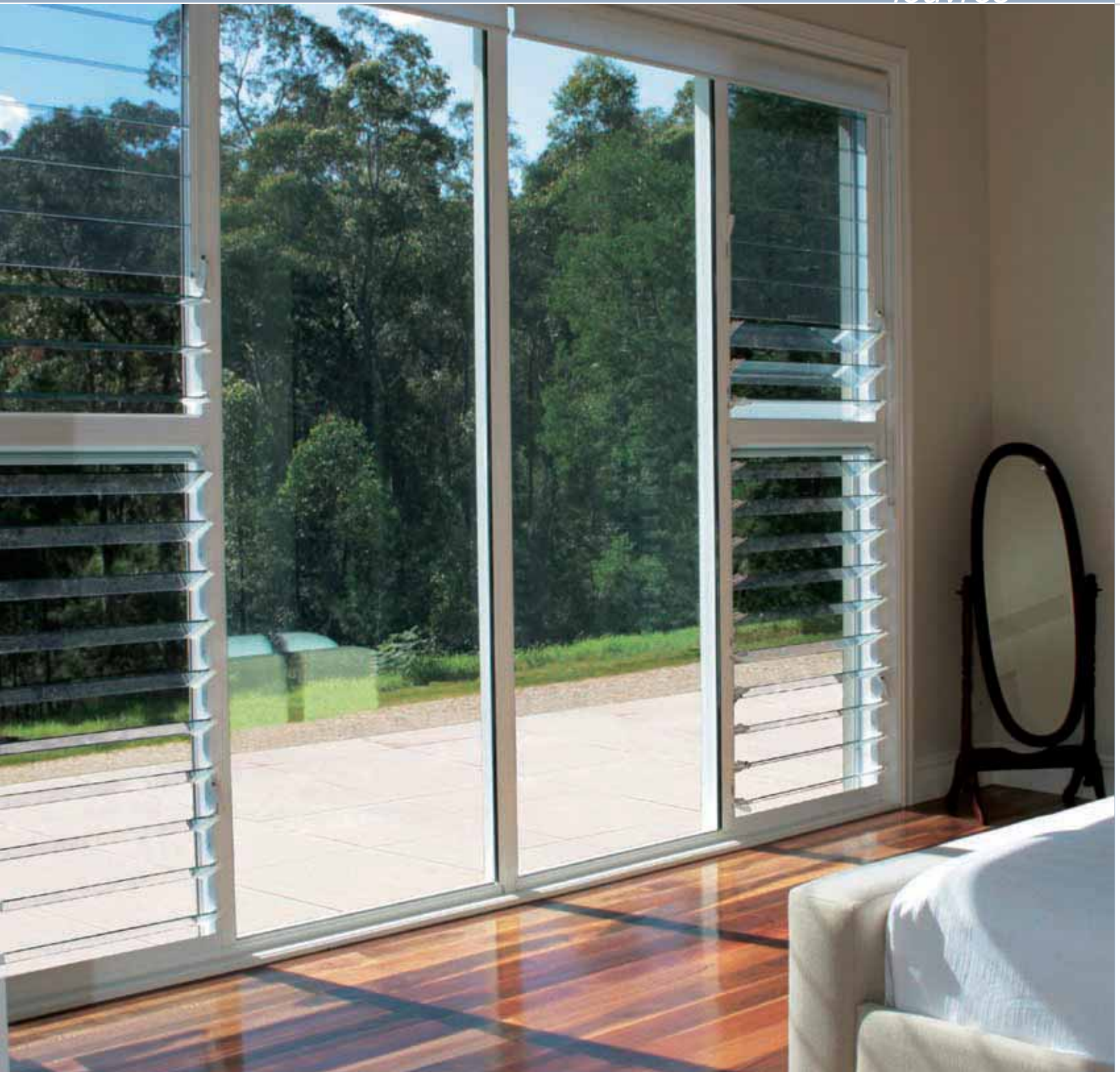

adjust to a change in climate

Louvres are the latest in window style!

An architectural renaissance born from the recognition that louvres not only look cool they are cool – offering superior flow through ventilation. In this climate of change Trend[®] has introduced a new generation louvre design featuring improved sealing and durability.

Trend[®] Louvres give a super tight weather-proof seal setting new standards for this contemporary classic. Blades come in glass, timber or metal and can be installed as a single frame or in combination with doors or windows.

features & benefits

- 1 **Energy Efficiency Options**
Trend® Thermashield® in various glazing styles are available to help reduce energy consumption. Trend® Thermashield® means greater control, bigger savings and most importantly one less thing to worry about. Energy efficient options to u-value of 4.2 and SHGC 0.33 are available for Trend® Louvre window.
- 2 **Acoustic Options**
SoundMizer® acoustic solutions in various STC ratings, are available to STC 23 for Trend® Louvre window. SoundMizer® acoustic solutions can reduce aircraft, highway traffic, railway and other annoying noise problems. For information or technical details contact Trend®.
- 3 **Mechanics**
Clever combination of T shaped aluminium bars and high strength acetal bearing has resulted in strong, non-corrosive operation, that extends the life of the louvre beyond the most stringent standard tests levels.
- 4 **High Performance**
Newly developed patented innovations, improve dramatically, the Trend® Louvres water and weather resistance. One of

these innovations, the unique “living hinge”, ensures an extremely firm fit between the louvre clips and the channel to resist water and air leakage. The overlapping shroud device on each clip creates a water-resistant seal between the clips. In extreme weather conditions the patented primary and secondary drainage channels, hidden within the clips, manage any water to the outside of the building.

- 5 **Handles**
Ergonomic curved handle is standard and is available in 25 different colours. Optional “O” ring handle is available for high up, out of reach applications. Low profile handle for door insertion applications is also available as an option, as is Handle Locking Bar for easier opening for ergonomic situations, i.e. retirement homes. Handles can be placed left or right, up high, or down low.
- 6 **Security**
Keyed lock is available as an option for applications where security is paramount, as is Security Bars to fit standard blade widths (Breezway 130mm Easy Frame louvre only).

- 7 **Glazing**
Louvre Blades are available in 152mm or 102mm height, 6mm toughened glass for strength and safety. Also blades are available in timber, aluminium or high performance extended warranty aluminium including photo image timber look. Trend® Louvre window, are one of the tightest sealing louvres on the market as well as high performing. Use of laminated glass is not recommended.
- 8 **Options**
Timber and Aluminium Blades. Select colour matching clips and handles to further enhance the Trend® Louvre Window. Frosted, etched or tinted toughened glass. “O” Ring Handle for high applications, Low Profile Handle and Handle Locking Bar. Keyed Locks and Security Bars. Insect Screens. Wide range of powdercoat finishes available including timber powdercoat finishes.

ordering details

All windows are illustrated as viewed from outside. Codes shown are for plain windows.

When using 130mm frame, minimum recommended reveals size is 135mm

Flyscreens can be readily fitted on the Trend® 130mm Surround Frame.

Blade thickness must be 6mm. Use of laminated glass for Trend® Louvres is not recommended

Select Colour matching clips and handles to further enhance the Trend® Louvre window

Keylock is optional

The first two numbers of code indicate approximate height, the last two numbers indicate approximate width

Maximum width for:

Single bank Louvres is 1002mm
Double bank louvres is 1982mm
Triple bank louvre is 2959mm
Four bank louvre is 3940mm
Five bank louvre is 4918mm

General:

When not using Weatherstip overall height will be reduced by 10mm

Note:

Louvre blades are available in Western Red Cedar, Aluminium or Toughened Glass

Ask your Trend® Sales Representative for more information.

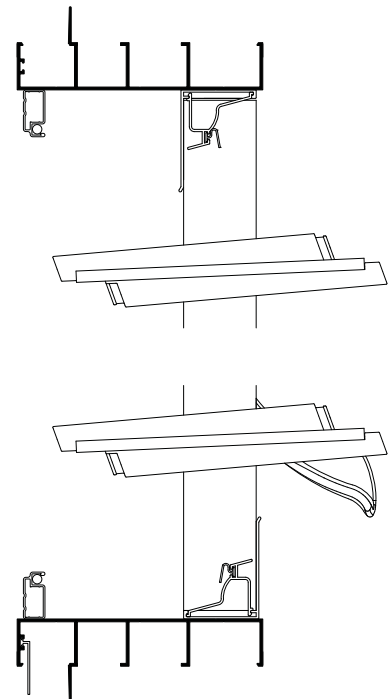

LOUVRE GALLERIES - 130MM SURROUND FRAME WITH 152MM BLADE HEIGHT

# of Blades	Frame Height	Frame Width	Glass Width	# of louvre banks	Codes	# of Blades	Frame Height	Frame Width	Glass Width	# of louvre banks	Codes	# of Blades	Frame Height	Frame Width	Glass Width	# of louvre banks	Codes
2	380	410	308	1	ATL0404/1	8	1220	410	308	1	ATL1204/1	14	2060	410	308	1	ATL2104/1
		610	508		610			508	ATL1206/1		610			508	ATL2106/1		
		910	808		910			808	ATL1209/1		910			808	ATL2109/1		
		1197	505		1197			505	ATL1212/2		1197			505	ATL2112/2		
		1797	808		1797			808	ATL1218/2		1797			808	ATL2118/2		
3	520	1784	508	3	ATL0418/3	9	1360	1784	508	3	ATL1404/1	15	2200	1784	508	3	ATL2204/1
		2684	808		2684			808	ATL0427/3		1406/1			2206/1			
		3571	808		3571			808	ATL0527/3		1409/1			2209/1			
		4458	808		4458			808	ATL0512/2		1412/2			2212/2			
									ATL0518/2		1418/2			2218/2			
4	660	1784	508	3	ATL0518/3	10	1500	1784	508	3	ATL1504/1	16	2340	1784	508	3	ATL2304/1
		2684	808		2684			808	ATL0727/3		1506/1			2306/1			
		3571	808		3571			808	ATL0736/4		1509/1			2309/1			
		4458	808		4458			808	ATL0712/2		1512/2			2312/2			
									ATL0718/2		1518/2			2318/2			
5	800	1784	508	3	ATL0818/3	11	1640	1784	508	3	ATL1604/1	17	2480	1784	508	3	ATL2404/1
		2684	808		2684			808	ATL0827/3		1606/1			2406/1			
		3571	808		3571			808	ATL0836/4		1609/1			2409/1			
		4458	808		4458			808	ATL0812/2		1612/2			2412/2			
									ATL0818/2		1618/2			2418/2			
6	940	1784	508	3	ATL0918/3	12	1780	1784	508	3	ATL1804/1	12	1780	1784	508	3	ATL2418/3
		2684	808		2684			808	ATL0927/3		1806/1			2406/1			
		3571	808		3571			808	ATL0936/4		1809/1			2409/1			
		4458	808		4458			808	ATL0912/2		1812/2			2412/2			
									ATL0918/2		1818/2			2418/2			
7	1080	1784	508	3	ATL1218/3	13	1920	1784	508	3	ATL1904/1	13	1920	1784	508	3	ATL2418/3
		2684	808		2684			808	ATL1227/3		1906/1			2406/1			
		3571	808		3571			808	ATL1236/4		1909/1			2409/1			
		4458	808		4458			808	ATL1245/5		1912/2			2412/2			
									ATL1204/1		1918/2			2418/2			

Samples of Trend® louvre banks that are available. (Single to Five Banks).

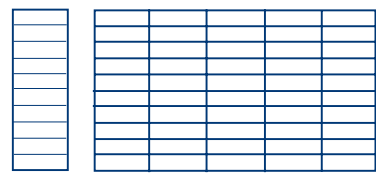

Single Bank Louvres 10 blades

Five Bank Louvres 10 blades

All windows and doors are designed to 700pa velocity and 150pa water rating. For higher ratings consult Trend® Windows & Doors.

sliding doors



live smooth

Trend® Sliding Doors make living smooth and easy - blending outdoors seamlessly with indoors. Create sliding walls of glass and add a fresh dimension to your home so it feels brighter and bigger.

Perfect for framing a view or making more of your garden and balconies, Trend® sliding doors come in variety of styles to suit both contemporary and more traditional designs.

Adjustable, extra durable rollers ensure they always glide easily and the powder coated finish is equally easy to look after.

Options include matching screen and barrier doors. Sump sills are available for exposed areas. Wheelchair access is made available by the Easyrider™ sill.

features & benefits

- 1 Energy Efficiency Options
Trend® Thermashield® in various glazing styles are available to help reduce energy consumption. Trend® Thermashield® means greater control, bigger savings and most importantly one less thing to worry about. Energy efficient options to u-value of 3.0 and SHGC 0.41 are available for Trend® Sliding Door.
- 2 Acoustic Options
SoundMizer® acoustic solutions in various STC ratings, are available to STC 38 for Trend® Sliding Door. SoundMizer® acoustic solutions can reduce aircraft, highway traffic, railway and other annoying noise problems.
For information or technical details contact Trend®.
- 3 Locks
Sliding doors are fitted standard with locks and can be upgraded to an optional D handle.
- 4 Safety Glazing
Toughened Safety A Grade Glass with a visual motif at the mid point to provide added safety. Laminated Glass is used in all non standard door sizes. Glass sits into the extrusion door glazing pocket up to 13mm. Double Glazing is available for energy efficiency requirements.
- 5 Protected Rolling Track
An extruded aluminium splayed threshold protects both glass door and flydoor rolling tracks.
- 6 Simple Access
The aluminium threshold features the Easyrider™ sill which is ideal for wheelchair access.
- 7 Heavy Duty Rollers
Trend® door uses a heavy duty roller system for smooth operation. Glass door panels roll on heavy duty adjustable acetel wheels, that are perfectly matched to the sill rail to ensure efficient running. The marine alloy aluminium carriage reduces the chance of corrosion ensuring a long and smooth operation.
- 8 Frames
Trend® Door frame is 101.6mm wide with standard locks. The sash has aesthetically pleasing lines and a smooth rounded profile that has a truly solid look.

Maximum Door Height is 2400mm
Maximum Panel Width is 1500mm
Maximum Door Width is 6010mm
- 9 Interlockers
Three types of interlockers are available depending on the structural pascal ratings. Trend® Sliding Door ultimate structural rating is 1500 pascals (kPa).
- 10 Optional Heavy Duty Barrier and Insect Screen Door
The sturdy extruded aluminium, external sliding flydoor is fitted with spring loaded acetel wheels that ensure the insect screen door stays on the track and opens smoothly.
- 11 Complementary Accessories
 - 180° non-load-bearing couplers.
 - 135° non-load-bearing corner couplers.
 - 100mm aluminium architraves for replacement door installations.
 - Adjustable aluminium storm mould.
 - Extruded aluminium 180° mullion covers to hide load-bearing posts.

- 12 Options
Colonial Bar, Federation Bar Layouts and Ovolo adaptor are available.
Easy to fit flyscreens.
Wide range of powdercoat finishes including Timber finishes available.

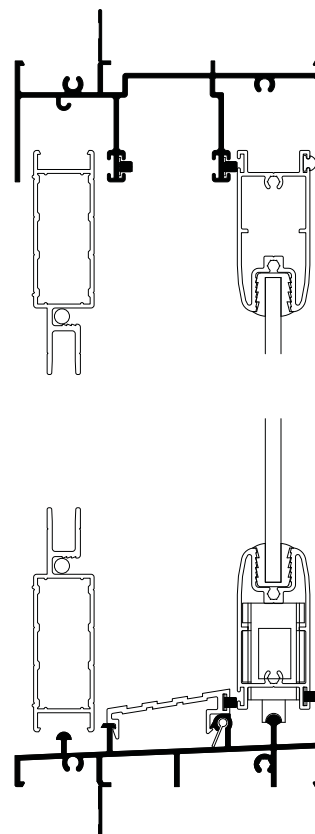

ordering details

All doors are illustrated as viewed from outside. Codes shown are for plain doors. The first two numbers of code indicate approximate height, the last two numbers indicate approximate width.

Sash Style Options:

Standard option is:
Eg door code TXD2018
O indicates ovolo sash style.
Eg door code TOXD2018
T indicates Thermashield® double glazed sash style. Eg door code TTXD2018
M indicates Acoustic sash style (SoundMizer®).
Eg door code TMXD2018
S indicates Sump Sill.
Eg door code TSXD2018

Bar Options:

CL indicates Colonial Bar.
Eg door code TXD2018CL
FD indicates Federation Bar.
Eg door code TXD2018FD

Configuration Options:

XF indicates Sliding/Fixed
FX indicates Fixed/Sliding
FXF indicates Fixed/Sliding/Fixed
FXXF indicates Fixed/Sliding/Sliding/Fixed

General:

Black hardware is supplied as standard
Two and Three panels doors available as reverse to brochure

Four panel doors have a prefix of TXXD
Low profile sill supplied as standard
The sill must be level side to side and front to back and fully supported during and after construction.

Note: The aluminium sill and external brick skin must be separated with an isolator to prevent possible reaction between brick and mortar and the aluminium frame which can lead to crevice corrosion.

** Refers to 2400 Frame Height

* Refer to Special Products on page 129 for Bar Layout Options

sliding doors

2121 2065 (S = 2090)	STUD OPENING	1556	1847	2209	2447	3066
	DOOR SIZE	1500	1791	2153	2391	3010
		TXD2015 **TXD2415	TXD2018 **TXD2418	TXD2021 **TXD2421	TXD2024 **TXD2424	TXD2030 **TXD2430

2121 2065 (S = 2090)	STUD OPENING	2741	3284	3641
	DOOR SIZE	2685	3228	3585
		TXD2027 **TXD2427	TXD2032 **TXD2432	TXD2036 **TXD2436

2121 2065 (S = 2090)	STUD OPENING	3601	4324	4800
	DOOR SIZE	3545	4268	4744
		TXXD2035 **TXXD2435	TXXD2043 **TXXD2443	TXXD2047 **TXXD2447

Note: The aluminium sill and external brick skin must be separated with an isolator to prevent possible reaction between brick and mortar and the aluminium frame which can lead to crevice corrosion.

** Refers to 2400 Frame Height

All windows and doors are designed to 700pa velocity and 150pa water rating. For higher ratings consult Trend® Windows & Doors.

QLD - features & benefits

- 1 Energy Efficiency Options
Trend® Thermashield® in various glazing styles are available to help reduce energy consumption. Trend® Thermashield® means greater control, bigger savings and most importantly one less thing to worry about. Energy efficient options to u-value of 3.0 and SHGC 0.41 are available for Trend® Sliding Door.
- 2 Acoustic Options
SoundMizer® acoustic solutions in various STC ratings, are available to STC 38 for Trend® Sliding Door. SoundMizer® acoustic solutions can reduce aircraft, highway traffic, railway and other annoying noise problems.
For information or technical details contact Trend®.
- 3 Locks
Sliding doors are fitted standard with Slimline handle and can be upgraded to an optional D handle.
- 4 Safety Glazing
Toughened Safety A Grade Glass with a visual motif at the mid point to provide added safety. Laminated Glass is used in all non standard door sizes. Glass sits into the extrusion door glazing pocket up to 13mm. Double Glazing is available for energy efficiency requirements.
- 5 Protected Rolling Track
An extruded aluminium splayed threshold protects both glass door and flydoor rolling tracks.
- 6 Simple Access
The aluminium threshold features the Easyrider™ sill which is ideal for wheelchair access.
- 7 Heavy Duty Rollers
Trend® door uses a heavy duty roller system for smooth operation.
Glass door panels roll on heavy duty adjustable acetel wheels, that are perfectly matched to the sill rail to ensure efficient running. The marine alloy aluminium carriage reduces the chance of corrosion ensuring a long and smooth operation.
- 8 Frames
Trend® Door frame is 101.6mm wide with Slimline Lawson. The sash has aesthetically pleasing lines and a smooth rounded profile that has a truly solid look.

Maximum Door Height is 2400mm
Maximum Panel Width is 1500mm
Maximum Door Width is 6010mm
- 9 Interlockers
Three types of interlockers are available depending on the structural pascal ratings. Trend® Sliding Door ultimate structural rating is 1500 pascals (kPa).
- 10 Optional Heavy Duty Barrier and Insect Screen Door
The sturdy extruded aluminium, external sliding flydoor is fitted with spring loaded acetel wheels that ensure the insect screen door stays on the track and opens smoothly.
- 11 Complementary Accessories
 - 180° non-load-bearing couplers.
 - 135° non-load-bearing corner couplers.
 - 100mm aluminium architraves for replacement door installations.
 - Adjustable aluminium storm mould.
 - Extruded aluminium 180° mullion covers to hide load-bearing posts.
- 12 Options
Colonial Bar, Federation Bar Layouts and Ovolo adaptor are available.
Easy to fit flyscreens.
Wide range of powdercoat finishes including Timber finishes available.

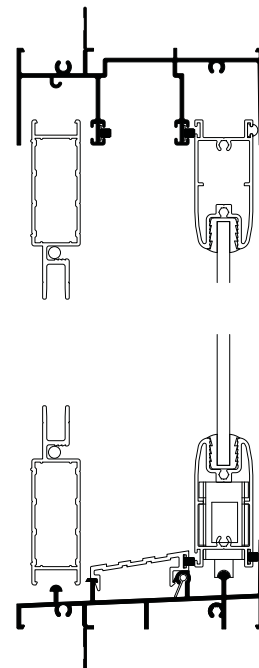

ordering details

All doors are illustrated as viewed from outside. Codes shown are for plain windows. The first two numbers of code indicate approximate height, the last two numbers indicate approximate width.

Sash Style Options:

Standard option is:
Eg door code TQXD2118
O indicates ovolo sash style.
Eg door code TOQXD2118CL
T indicates Thermashield® double glazed sash style. Eg door code TTQXD2114CL
M indicates Acoustic sash style (SoundMizer®).
Eg door code TMQXD2118
S indicates Sump Sill.
Eg door code TSQXD2118

Bar Options:

CL indicates Colonial Bar.
Eg door code TOQXD2118CL
FD indicates Federation Bar.
Eg door code QX2018FD

Configuration Options:

XF indicates Sliding/Fixed
FX indicates Fixed/Sliding
FXF indicates Fixed/Sliding/Fixed
FXXF indicates Fixed/Sliding/Sliding/Fixed

General:

Black hardware is supplied as standard
Two and Three panel doors available as reverse to brochure
Four panel doors have a prefix of TQXX

Low profile sill supplied as standard
The sill must be level side to side and front to back and fully supported during and after construction

Note:

The aluminium sill and external brick skin must be separated with an isolator to prevent possible reaction between brick and mortar and the aluminium frame which can lead to crevice corrosion.

** Refers to 2400 Frame Height

* Refer to Special Products on page 129 for Bar Layout Options

QLD - sliding doors

QLD ONLY

2130 2100 (S = 2125)	STUD OPENING	1560	1860	2160	2460
	DOOR SIZE	1510	1810	2110	2410
		TQXD2115 **TQXD2415	TQXD2118 **TQXD2418	TQXD2121 **TQXD2421	TQXD2124 **TQXD2424

2130 2100 (S = 2125)	STUD OPENING	2760	3215	3665
	DOOR SIZE	2714	3164	3614
		TQXD2127 **TQXD2427	TQXD2131 **TQXD2431	TQXD2136 **TQXD2436

2130 2100 (S = 2125)	STUD OPENING	3035	3635	4235	4835
	DOOR SIZE	2984	3582	4182	4782
		TQXXD2130 **TQXXD2430	TQXXD2135 **TQXXD2435	TQXXD2142 **TQXXD2442	TQXXD2148 **TQXXD2448

Note: ** Refers to 2400 Frame Height

All windows and doors are designed to 700pa velocity and 150pa water rating. For higher ratings consult Trend® Windows & Doors.

alfresco stacker & corner stacker doors



a more perceptive perspective

Trend[®] Alfresco Stacker Doors slide-away to give a completely open air feeling. They're a great way to give your home a modern alfresco look - you can design stylish outdoor indoor rooms that suit the way you want to live.

Flexible formats and sizes give you a two thirds opening for easy access to balconies or patios.

Corner stacker doors will open up a courtyard and create a sophisticated outlook.

Quality fittings ensure they always glide smoothly while aluminium construction guarantees the good looks last.

features & benefits

1 Energy Efficiency Options
Trend® Thermashield® in various glazing styles are available to help reduce energy consumption. Trend® Thermashield® means greater control, bigger savings and most importantly one less thing to worry about. Energy efficient options to u-value of 3.0 and SHGC 0.41 are available for Trend® Sliding Stacker Door.

2 Acoustic Options
SoundMizer® acoustic solutions in various STC ratings, are available to STC 38 for Trend® Sliding Stacker Door. SoundMizer® acoustic solutions can reduce aircraft, highway traffic, railway and other annoying noise problems. For information or technical details contact Trend®.

3 Locks
Sliding doors are fitted with standard lock and can be upgraded. Ask your Trend® Sales Consultant for more options.

4 Safety Glazing
Toughened Safety A Grade Glass with a visual motif at the mid point to provide added safety. Laminated Glass is used in all non standard door sizes. Glass sits into the extrusion door glazing pocket up to 13mm.

Double Glazing is available for energy efficiency requirements.

5 Protected Rolling Track
An extruded aluminium splayed threshold protects both glass door and flydoor rolling tracks.

6 Simple Access
The aluminium threshold features the Easyrider™ sill which is ideal for wheelchair access.

7 Heavy Duty Rollers
Trend® door uses a heavy duty roller system for smooth operation.

Glass door panels roll on heavy duty adjustable acetal wheels, that are perfectly matched to the sill rail to ensure efficient running. The marine alloy aluminium carriage reduces the chance of corrosion ensuring a long and smooth operation.

8 Frames
Trend® Door frame is 162mm wide (including flyscreen track) with the slimline sash. The sash has aesthetically pleasing lines and a smooth rounded profile that has a truly solid look.

Maximum Door Height is 2400mm
Maximum Panel Width is 1500mm
Maximum Door Width - 3 lites 4500mm
Maximum Door Width - 6 lites is 6400mm

9 Interlockers
Three types of interlockers are available depending on the structural pascal ratings. Trend® Sliding Door ultimate structural rating is 1500 pascals (kPa).

10 Optional Heavy Duty Barrier and Insect Screen Door
The sturdy extruded aluminium, external sliding flydoor is fitted with spring loaded acetal wheels that ensure the insect screen door stays on the track and opens smoothly.

11 Complementary Accessories

- 180° non-load-bearing couplers.
- 135° non-load-bearing corner couplers.
- 100mm aluminium architraves for replacement door installations.
- Adjustable aluminium storm mould.
- Extruded aluminium 180° mullion covers to hide load-bearing posts.

12 Options
Colonial Bar, Federation Bar Layouts and Ovolo adaptor are available. Easy to fit flyscreens. Wide range of powdercoat finishes including Timber finishes available.

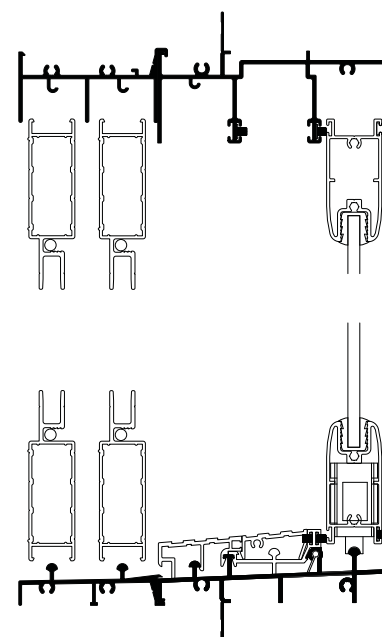

ordering details

All doors are illustrated as viewed from outside. Codes shown are for plain doors. The first two numbers of code indicate approximate height, the last two numbers indicate approximate width.

Sash Style Options:

Standard option is:
Eg door code TSD2022
O indicates ovolo sash style.
Eg door code TOSD2022
T indicates Thermashield® double glazed sash style. Eg door code TTSD2022
M indicates Acoustic sash style (SoundMizer®). Eg door code TMSD2018
S indicates Sump Sill.
Eg door code TSSD2018

Bar Options:

CL indicates Colonial Bar.
Eg door code TSD2022CL
FD indicates Federation Bar.
Eg door code TSD2022FD

Configuration Options:

XXF indicates Sliding/Sliding/Fixed
FXX indicates Fixed/Sliding/Sliding
FXXXF indicates Fixed/Sliding/Sliding/Sliding/Fixed

General:

Black hardware is supplied as standard
Low profile sill supplied as standard
The sill must be level side to side

and front to back and fully supported during and after construction

Note:

The aluminium sill and external brick skin must be separated with an isolator to prevent possible reaction between brick and mortar and the aluminium frame which can lead to crevice corrosion.

** Refers to 2400 Frame Height

* Refer to Special Products on page 129 for Bar Layout Options

alfresco stacker doors

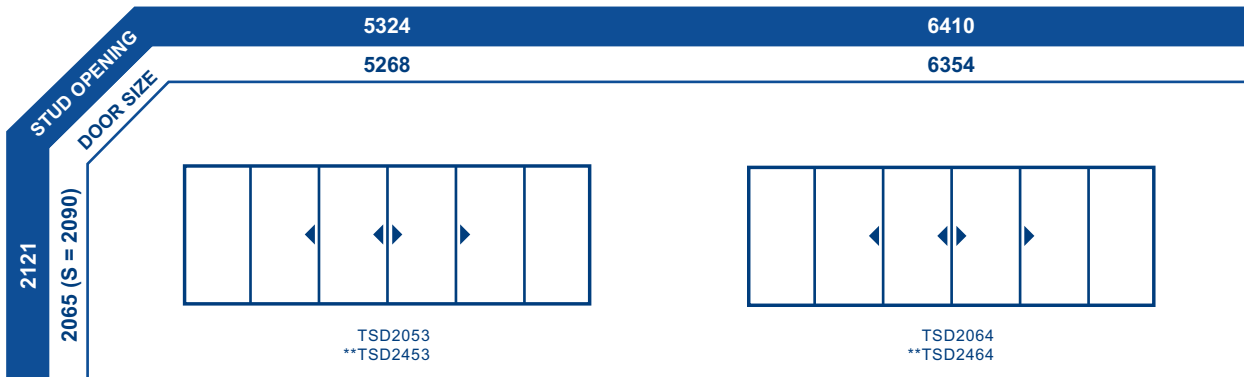
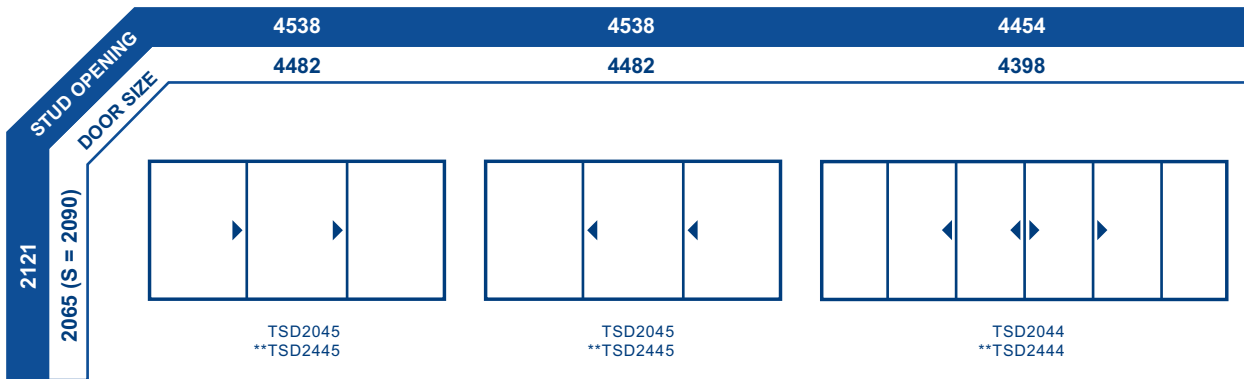
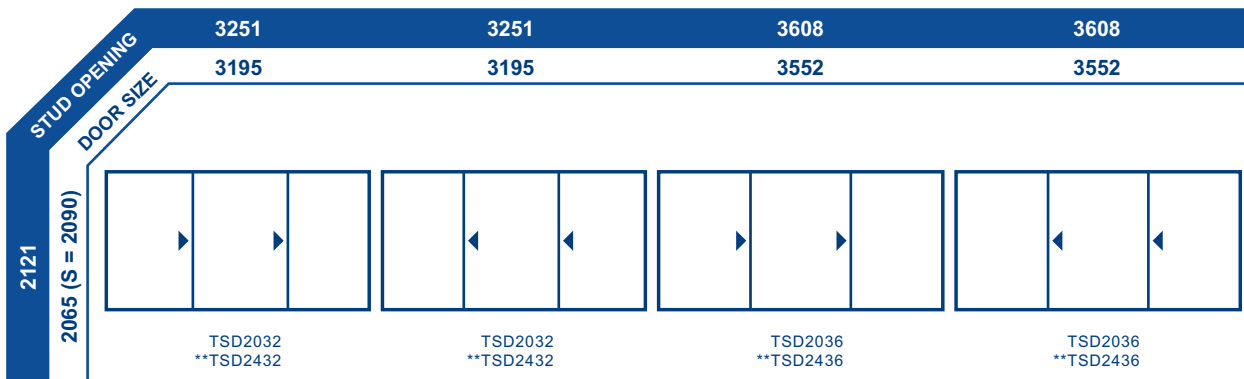
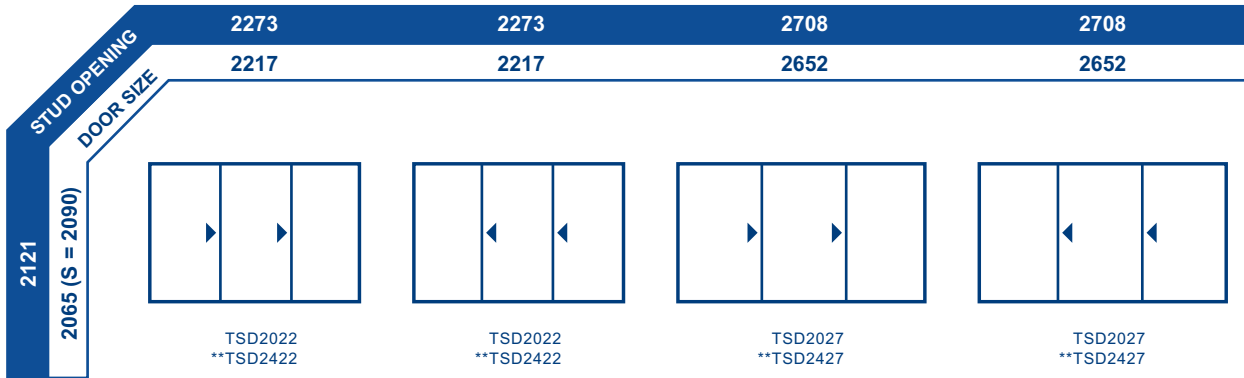

Note: ** Refers to 2400 Frame Height

All windows and doors are designed to 700pa velocity and 150pa water rating. For higher ratings consult Trend® Windows & Doors.

QLD - features & benefits

1 Energy Efficiency Options
Trend® Thermashield® in various glazing styles are available to help reduce energy consumption. Trend® Thermashield® means greater control, bigger savings and most importantly one less thing to worry about. Energy efficient options to u-value of 3.0 and SHGC 0.41 are available for Trend® Sliding Stacker Door.

2 Acoustic Options
SoundMizer® acoustic solutions in various STC ratings, are available to STC 38 for Trend® Sliding Stacker Door. SoundMizer® acoustic solutions can reduce aircraft, highway traffic, railway and other annoying noise problems. For information or technical details contact Trend®.

3 Locks
Sliding doors are fitted with standard lock and can be upgraded. Ask your Trend® Sales Consultant for more options.

4 Safety Glazing
Toughened Safety A Grade Glass with a visual motif at the mid point to provide added safety. Laminated Glass is used in all non standard door sizes. Glass sits into the extrusion door glazing pocket up to 13mm.

Double Glazing is available for energy efficiency requirements.

5 Protected Rolling Track
An extruded aluminium splayed threshold protects both glass door and flydoor rolling tracks.

6 Simple Access
The aluminium threshold features the Easyrider™ sill which is ideal for wheelchair access.

7 Heavy Duty Rollers
Trend® door uses a heavy duty roller system for smooth operation.

Glass door panels roll on heavy duty adjustable acetal wheels, that are perfectly matched to the sill rail to ensure efficient running. The marine alloy aluminium carriage reduces the chance of corrosion ensuring a long and smooth operation.

8 Frames
Trend® Door frame is 162mm wide (including flyscreen track) with the slimline sash. The sash has aesthetically pleasing lines and a smooth rounded profile that has a truly solid look.

Maximum Door Height is 2400mm
Maximum Panel Width is 1500mm
Maximum Door Width - 3 lites 4500mm
Maximum Door Width - 6 lites is 6400mm

9 Interlockers
Three types of interlockers are available depending on the structural pascal ratings. Trend® Sliding Door ultimate structural rating is 1500 pascals (kPa).

10 Optional Heavy Duty Barrier and Insect Screen Door
The sturdy extruded aluminium, external sliding flydoor is fitted with spring loaded acetal wheels that ensure the insect screen door stays on the track and opens smoothly.

11 Complementary Accessories

- 180° non-load-bearing couplers.
- 135° non-load-bearing corner couplers.
- 100mm aluminium architraves for replacement door installations.
- Adjustable aluminium storm mould.
- Extruded aluminium 180° mullion covers to hide load-bearing posts.

12 Options
Colonial Bar, Federation Bar Layouts and Ovolo adaptor are available. Easy to fit flyscreens. Wide range of powdercoat finishes including Timber finishes available.

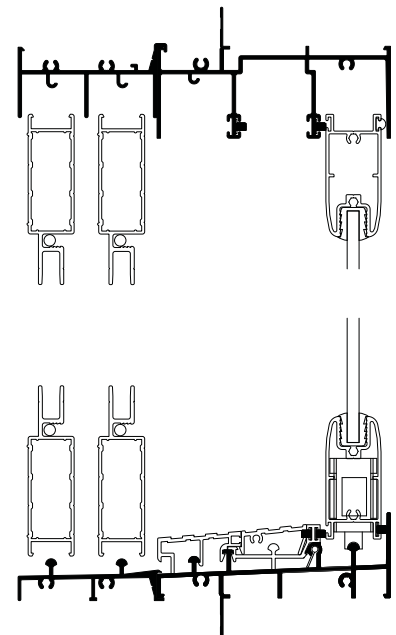

ordering details

All doors are illustrated as viewed from outside. Codes shown are for plain windows. The first two numbers of code indicate approximate height, the last two numbers indicate approximate width.

Sash Style Options:

Standard option is:
Eg door code TQSD2022
O indicates ovolo sash style.
Eg door code TQOSD2022
T indicates Thermashield® double glazed sash style. Eg door code TQSD2022
M indicates Acoustic sash style (SoundMizer®).
Eg door code TQMSD2018
S indicates Sump Sill.
Eg door code TQSSD2018

Bar Options:

CL indicates Colonial Bar.
Eg door code TQSD2022CL
FD indicates Federation Bar.
Eg door code TQSD2022FD

Configuration Options:

XXF indicates Sliding/Sliding/Fixed
FXX indicates Fixed/Sliding/Sliding
FXXXXF indicates Fixed/Sliding/Sliding/Sliding/Sliding/Fixed

General:

- Black hardware is supplied as standard
- Low profile sill supplied as standard

- The sill must be level side to side and front to back and fully supported during and after construction.

Note:

The aluminium sill and external brick skin must be separated with an isolator to prevent possible reaction between brick and mortar and the aluminium frame which can lead to crevice corrosion.

** Refers to 2400 Frame Height

* Refer to Special Products on page 129 for Bar Layout Options

QLD - alfresco stacker doors

QLD ONLY

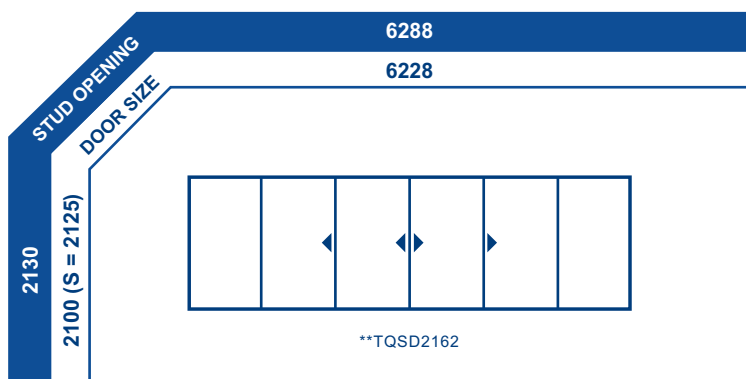
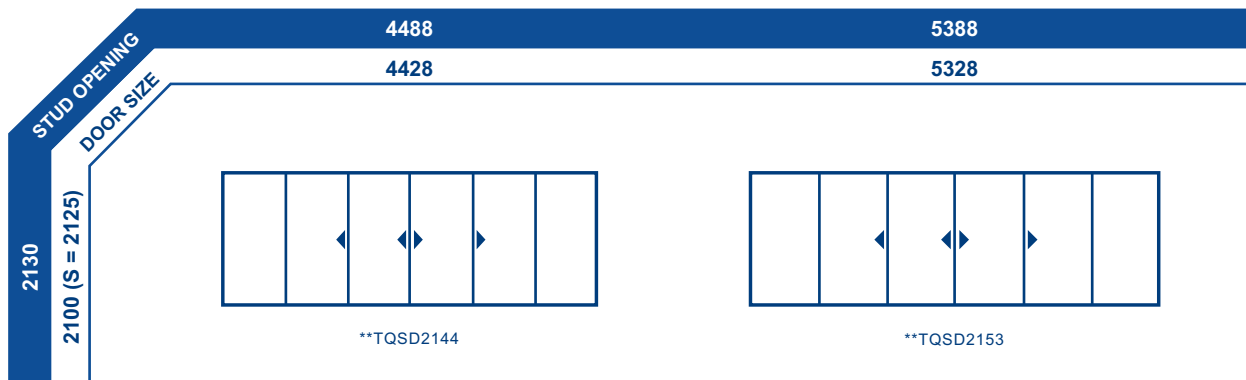
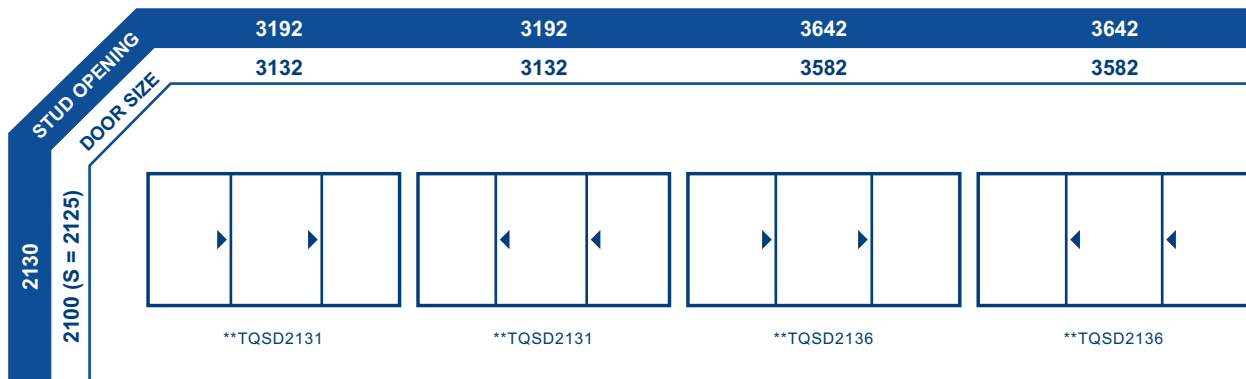
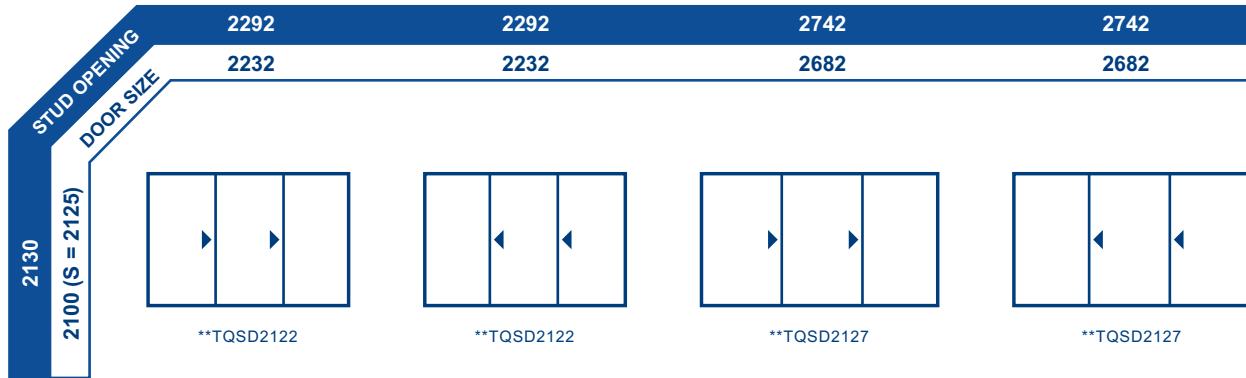

Note: ** Refers to 2400 Frame Height

All windows and doors are designed to 700pa velocity and 150pa water rating. For higher ratings consult Trend® Windows & Doors.

hinged doors



Optional ovolo colonial style shown

make an entry

Trend® knows doors inside out. More than just a means to an end, the right door will transform the flow of a room or an entire house, bringing the outdoors in and making the most of available space.

Whether you're looking for a traditional frame, something more contemporary or classic French doors, we'll help you find exactly the right design to suit the character of your home.

Combinations of glass and/or aluminium raised or flat panels can be combined with any door to make a grand statement or simply let the sun shine in. Ovolo colonial style small pane glass panels can be added - giving you a timeless timber look with all the durability and strength of aluminium.

All our aluminium doors are available in a range of powder coated and timber grain finishes and glass options can be specified as required.

features & benefits

- 1 Energy Efficiency Options
Trend® Thermashield® in various glazing styles are available to help reduce energy consumption. Trend® Thermashield® means greater control, bigger savings and most importantly one less thing to worry about. Energy efficient options to u-value of 4.2 and SHGC 0.27 are available for Trend® Provincial Hinged Door.
- 2 Acoustic Options
SoundMizer® acoustic solutions in various STC ratings, are available to STC 35 for Trend® Provincial Hinged Door. SoundMizer® acoustic solutions can reduce aircraft, highway traffic, railway and other annoying noise problems. For information or technical details contact Trend®.
- 3 Safety Glazing
Toughened Safety A Grade Glass with a visual motif at the mid point to provide added safety. Laminated Glass is used in all non standard door sizes. Double Glazing is available for energy efficiency requirements.
- 4 Locks
Standard patio deadlock is fitted for security. Optional three point locking is also available.
- 5 Hinges
The door is hung on special offset fast-fix hinges to eliminate binding. The door can also be supplied with Parliament hinges where the door is to swing out flush to brickwork.
- 6 Direction of Opening
The door can be ordered as open in or open out.
- 7 Drained Sill
Standard on the door is the fully drained sill to improve the weathering on the door.
- 8 Matching Sidelites
Matching sidelites in the style of the swing doors are available as an option to Trend® Provincial Hinged Doors, as well as highlites, arches or other options.
- 9 Timber Entrance Door
Where there is the need for a Timber Entrance Door, the frame can

accommodate a 40mm Exterior Timber Door in either open out or open in with the drained sill.

- 10 Options
Flyscreen door is available. Colonial Bar and Federation Bar Layouts are available in Trend® Ovolo system. Wide range of powdercoat finishes including timber finishes available.

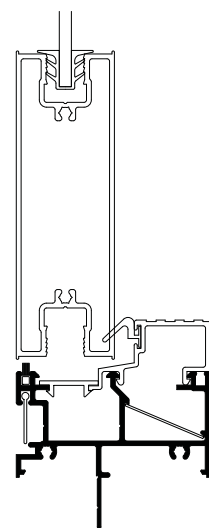
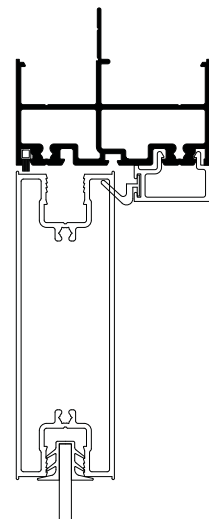

ordering details

All doors are illustrated as viewed from outside. The number in the code indicates width of the frame to suit either a 620, 720 or 820 door.

AP Indicates Aluminium Provincial Door. When specifying door type, firstly select frame size. Eg AP898

Select door style by placing the code after the frame size. Eg AP898/8L

Opening

OI indicates door Opens In.
Eg AP898/8L-OI
OO indicates doors Opens Out.
Eg AP898/8L-OO

Sash Style Options:

Standard option is:
Eg door code AP898/CR-OI

O indicates ovolo sash style.
Eg door code APO898/ 8L
T indicates Thermashield® double glazed sash style. Eg door code ATP898/CR-OI
M indicates Acoustic sash style (SoundMizer®).
Eg door code AMP898/CR-OI

Side lites:

Side lites are available in a 430mm standard size.
To order place APF430 in front of style shown.
Eg APF430-4L

General:

Black hardware is supplied as standard

* Refer to Special Products on page 129 for Bar Layout Options

provincial doors

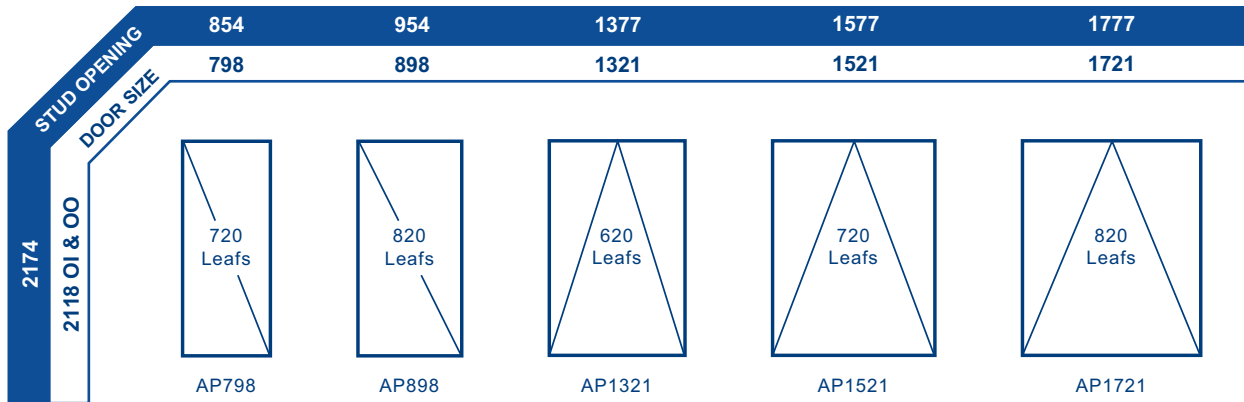

DOORS

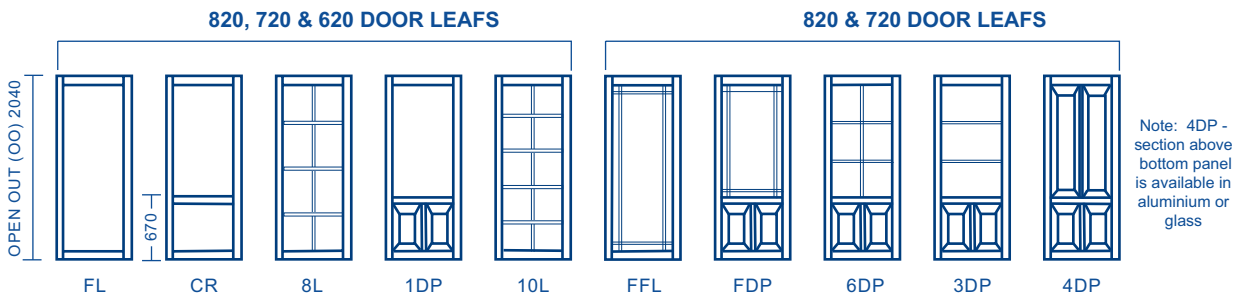

DOORS

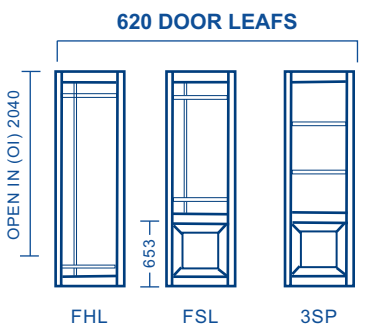

SIDE LITES

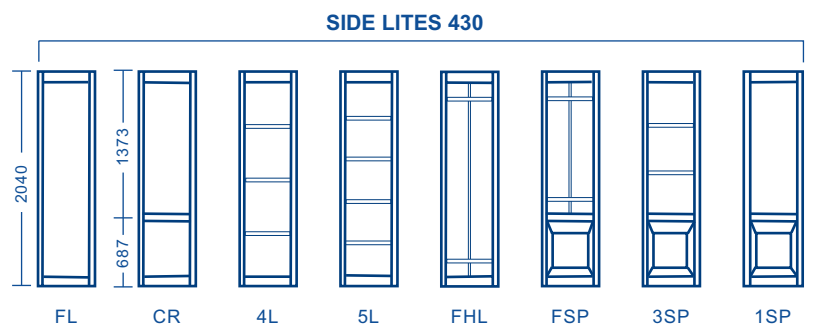

All windows and doors are designed to 700pa velocity and 150pa water rating. For higher ratings consult Trend® Windows & Doors.

bifold doors



widen your thinking

Trend® Bi-fold doors give you extra breathing space, folding the outside in and capturing more of the natural light. They give you the flexibility to open up some or all of a room while making more of your available space when compared to traditional doors.

We can also custom build bi-fold doors to your design, giving you even greater scope to add character and style to your home.

Quality stainless steel hardware combined with durable maintenance free aluminium, guarantees years of trouble free use. And you can choose from a range of powder coated or timber grain finishes.

features & benefits

- 1 Energy Efficiency Options
Trend® Thermashield® in various glazing styles are available to help reduce energy consumption. Trend® Thermashield® means greater control, bigger savings and most importantly one less thing to worry about. Energy efficient options to u-value of 3.4 and SHGC 0.36 are available for Trend® Bifold door.
- 2 Acoustic options
SoundMizer® acoustic solutions in various STC ratings, are available to STC 35 for Trend® Bifold door. SoundMizer® acoustic solutions can reduce aircraft, highway traffic, railway and other annoying noise problems. For information or technical details contact Trend®.
- 3 Door Hardware
Stainless steel hardware is provided as standard. Door hardware, hinges and drop bolts are available in three finishes, stainless steel, gold and black powder coat.
- 4 Safety Glazing
Toughened Safety A Grade Glass with a visual motif at the mid point to provide added safety. Laminated Glass is used in all non standard door sizes. Double Glazing is available for energy efficiency requirements.
- 5 Frames
The weight of the bifold doors must be considered in the structural beam calculation of the overall structure. The bifold door and frame are not structural elements and the head of the frame should be attached to the structural beam.

Maximum Frame Height is 2700mm
Maximum Frame Width is 6062mm
Maximum Door Leaf Size is 870mm
Maximum Weight in one direction is 180kg
- 6 Protective Wrapping
Protective wrapping for delivery to site is an option for all Trend® products.
- 7 Options
Wide range of powdercoat finishes including Timber finishes available.
NOTE: Available open out only.

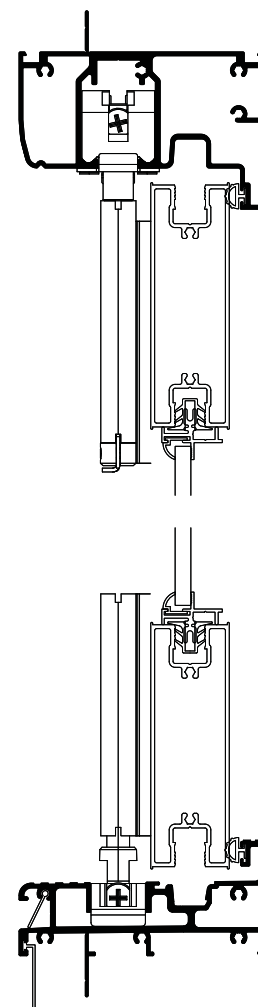

ordering details

All doors are illustrated as viewed from outside. Codes shown are for plain doors.

The first two numbers of code indicate approximate height, the last two numbers indicate approximate width.

Sash Style Options:

Standard option is:
Eg door code ABF2214/2L
O indicates ovolo sash style.
Eg door code AOBF2214/2LCL
T indicates Thermashield® double glazed sash style. Eg door code ATBF2214/2L
M indicates Acoustic sash style (SoundMizer®).
Eg door code AMBF2214/2L

Bar Options:

CL indicates Colonial Bar.
Eg door code ABF2214/2LCL
FED indicates Federation Bar.
Eg door code ABF2214/2LFED

Configuration Options:

Configuration is shown at the end of the code.
Eg door code ABF2220/1L2R (1Left, 2Right)

Note:

The weight of the bifold doors must be considered in the structural beam calculation of the overall structure.































The bifold door and frame are not structural elements and the head of the frame should be

attached to the structural beam.
Available open out only.

Maximum frame height 2700.
Maximum door leaf size 870.
Maximum weight in one direction 180kg.
Maximum width size is 6.065 metres.
Maximum width of 6 Panel is 5300mm.
Maximum width of 7 Panel is 6065mm.

* Refer to Special Products on page 129 for Bar Layout Options

bifold door systems

STUD OPENING DOOR		FRAME WIDTH + 56mm				
		Frame Width	Leaf Directions	Leaf #	Door Code	
FRAME HEIGHT + 56mm 2165 STANDARD HEIGHT 2700MAX. HEIGHT	 2 PANELS 1800 MAX. WIDTH	1388		2L	ABF2214/2L ABF2216/2L ABF2218/2L	
		1588		2R	ABF2214/2R ABF2216/2R ABF2218/2R	
		1788				
	 3 PANELS 2700 MAX. WIDTH	2043		3L	ABF2220/3L ABF2223/3L ABF2226/3L	
		2343		3R	ABF2220/3R ABF2223/3R ABF2226/3R	
		2643				
		2046		2L 1R	ABF2220/2L1R ABF2223/2L1R ABF2226/2L1R	
		2346		1L 2R	ABF2220/1L2R ABF2223/1L2R ABF2226/1L2R	
		2646				
	 4 PANELS 3500 MAX. WIDTH	2700		3L 1R	ABF2227/3L1R ABF2231/3L1R ABF2235/3L1R	
		3100		1L 3R	ABF2227/1L3R ABF2231/1L3R ABF2235/1L3R	
		3500				
2696			2L 2R	ABF2227/2L2R ABF2231/2L2R ABF2235/2L2R		
3096			4L	ABF2227/4L ABF2231/4L ABF2235/4L		
3496			4R	ABF2227/4R ABF2231/4R ABF2235/4R		
						
						
 5 PANELS 4400 MAX. WIDTH	3350		5L	ABF2234/5L ABF2239/5L ABF2244/5L		
	3860		5R	ABF2234/5R ABF2239/5R ABF2244/5R		
	4360					
	3360		4L 1R	ABF2234/4L1R ABF2239/4L1R ABF2244/4L1R		
	3860		1L 4R	ABF2234/1L4R ABF2239/1L4R ABF2244/1L4R		
	4360					
	3355		3L 2R	ABF2234/3L2R ABF2239/3L2R ABF2244/3L2R		
	3855		2L 3R	ABF2234/2L3R ABF2239/2L3R ABF2244/2L3R		
	4355					

features & benefits

- 1 Energy Efficiency Options
Trend® Thermashield® in various glazing styles are available to help reduce energy consumption. Trend® Thermashield® means greater control, bigger savings and most importantly one less thing to worry about. Energy efficient options to u-value of 3.4 and SHGC 0.36 are available for Trend® Bifold door.
- 2 Acoustic options
SoundMizer® acoustic solutions in various STC ratings, are available to STC 35 for Trend® Bifold door. SoundMizer® acoustic solutions can reduce aircraft, highway traffic, railway and other annoying noise problems. For information or technical details contact Trend®.
- 3 Door Hardware
Stainless steel hardware is provided as standard. Door hardware, hinges and drop bolts are available in three finishes, stainless steel, gold and black powder coat.
- 4 Safety Glazing
Toughened Safety A Grade Glass with a visual motif at the mid point to provide added safety. Laminated Glass is used in all non standard door sizes. Double Glazing is available for energy efficiency requirements.
- 5 Frames
The weight of the bifold doors must be considered in the structural beam calculation of the overall structure. The bifold door and frame are not structural elements and the head of the frame should be attached to the structural beam.

Maximum Frame Height is 2700mm
Maximum Frame Width is 6062mm
Maximum Door Leaf Size is 870mm
Maximum Weight in one direction is 180kg
- 6 Protective Wrapping
Protective wrapping for delivery to site is an option for all Trend® products.
- 7 Options
Wide range of powdercoat finishes including Timber finishes available.
NOTE: Available open out only.

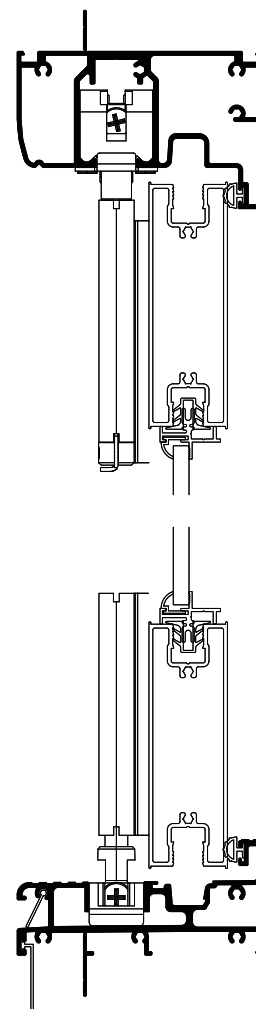

ordering details

All doors are illustrated as viewed from outside. Codes shown are for plain doors.

The first two numbers of code indicate approximate height, the last two numbers indicate approximate width.

Sash Style Options:

Standard option is:

Eg door code ABF2214/2L

O indicates ovolo sash style.

Eg door code AOBF2214/2LCL

T indicates Thermashield® double glazed sash style. Eg door code ATBF2214/2L

M indicates Acoustic sash style (SoundMizer®).

Eg door code AMBF2214/2L

Bar Options:

CL indicates Colonial Bar.

Eg door code ABF2214/2LCL

FED indicates Federation Bar.

Eg door code ABF2214/2LFED

Configuration Options:

Configuration is shown at the end of the code.

Eg door code ABF2220/1L2R (1Left, 2Right)

Note:

The weight of the bifold doors must be considered in the structural beam calculation of the overall structure.

The bifold door and frame are not structural elements and the head of the frame should be attached to the structural beam.

Available open out only.

Maximum frame height 2700.

Maximum door leaf size 870.

Maximum weight in one direction 180kg.

















Maximum width size is 6.065 metres.

Maximum width of 6 Panel is 5300mm.

Maximum width of 7 Panel is 6065mm.

* Refer to Special Products on page 129 for Bar Layout Options

bifold door systems

FRAME WIDTH + 56mm		Frame Width	Leaf Directions	Leaf #	Door Code	
<p>STUD OPENING DOOR</p> <p>FRAME HEIGHT + 56mm</p> <p>2165 STANDARD HEIGHT 2700 MAX. HEIGHT</p>	 <p>6 PANELS 5300 MAX. WIDTH</p>	4002		6L	ABF2240/6L ABF2246/6L ABF2252/6L	
		4602		6R	ABF2240/6R ABF2246/6R ABF2252/6R	
		5202		4L 2R	ABF2240/4L2R ABF2246/4L2R ABF2252/4L2R	
				2L 4R	ABF2240/2L4R ABF2246/2L4R ABF2252/2L4R	
		 <p>7 PANELS 6065 MAX. WIDTH</p>	4008		3L 3R	ABF2240/3L3R ABF2246/3L3R ABF2252/3L3R
			4608		5L 1R	ABF2240/5L1R ABF2246/5L1R ABF2252/5L1R
	5208			1L 5R	ABF2240/1L5R ABF2246/1L5R ABF2252/1L5R	
	4653			7L	ABF2247/7L ABF2253/7L ABF2261/7L	
	5353			7R	ABF2247/7R ABF2253/7R ABF2261/7R	
	6053					
	4662			5L 2R	ABF2247/5L2R ABF2254/5L2R ABF2261/5L2R	
			5362		2L 5R	ABF2247/2L5R ABF2254/2L5R ABF2261/2L5R
					4L 3R	ABF2247/4L3R ABF2254/4L3R ABF2261/4L3R
		6062		3L 4R	ABF2247/3L4R ABF2254/3L4R ABF2261/3L4R	
				1L 6R	ABF2247/1L6R ABF2254/1L6R ABF2261/1L6R	
				6L 1R	ABF2247/6L1R ABF2254/6L1R ABF2261/6L1R	

entry frames



first in-first impressions

They say you never get a second chance to make a first impression.

Trend® Entry Frames are all about creating a lasting first impression. Elegantly grand or stylishly minimalist, contemporary or traditional.

Whatever your preference, we'll help you create something special. Something that's more than just a front entry.

quantum xp[®] quality speaks for itself

Quantum XP[®] windows and doors open a new era in aluminium.

The patented Van Door sealing system helps create superior levels of quality, durability and practicality. Major improvements in thermal insulation, reduce heating and cooling costs and at the same time minimise dust, condensation and noise.

Quantum XP[®] also gives aluminium a fresh aesthetic look – the 55mm sash enhances the clean lines of contemporary homes and gives the solid feel of timber in more traditional homes.

The Quantum range has the flexibility to suit all types of building design. The robust high end features mean Quantum windows and doors can be confidently used in the harshest cold, marine, desert or tropical environments.

So take a fresh look at aluminium and build Quantum XP[®] quality into your home.

quantum xp[®]

Quantum XP[®] Windows

Awning	69
Casement	73
Premium Sliding	77

Quantum Doors

Sliding	81
Sliding Stacker	85

awning windows



eye to the future

When you're looking for quality and style make sure you're looking out at the world through Quantum XP® Awning Windows.

Maximising space and light with contemporary, clean designs awning windows are great for creating a sense of size. Perfect for showing off the view.

On a practical level, high quality optional stainless steel chain winders stop windows slamming, while the hood protects against the elements.

features & benefits

- 1 Energy Efficiency Options
Trend® Thermashield® in various glazing styles are available to help reduce energy consumption. Trend® Thermashield® means greater control, bigger savings and most importantly one less thing to worry about. Energy efficient options to u-value of 4.0 and SHGC 0.37 are available for Quantum XP® Awning window.
- 2 Acoustic options
SoundMizer® acoustic solutions in various STC ratings, are available to STC 39 for Quantum XP® Awning window. SoundMizer® acoustic solutions can reduce aircraft, highway traffic, railway and other annoying noise problems. For information or technical details contact Trend®.
- 3 Key Lock Chain Winder
Quantum XP® Awning window winder mechanism is designed specifically for high performance, security and reliability. With a Polesium™ cover and base combined with a stainless steel chain for long life and reliability, the XP winder can be used in even the harshest environment without worry of corrosion. The robust mechanisms are mounted securely to the window with a concealed 4 point fixing.

Keyed lock is standard for added security.
- 4 Continuous Hinge Hood
The sash is protected from the weather by a continuous hinge hood that supports the sash and keeps the rain where it belongs on the outside.
- 5 Glazing
Quantum XP® Premium sash is also available in 16mm double glazing for energy efficiency applications. Acoustic solutions are also available to high STC ratings.
- 6 Frames
Quantum XP® Awning Premium frame is 65mm with the window sash 55mm wide. Quantum XP® has a truly solid look, reminiscent of timber, and is extremely popular in both traditional and contemporary house designs.
- 7 Window Placement
Care should be taken with locating opening awning windows in pedestrian traffic areas.
- 8 Protective Wrapping
Protective wrapping for delivery to site is a standard for all Quantum XP® products.
- 9 Options
Easy to fit flyscreens can be fitted and removed from the inside. Wide range of powdercoat finishes available including timber powdercoat finishes.

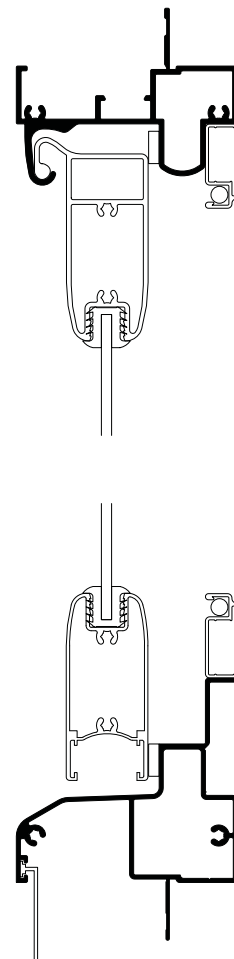

ordering details

All windows are illustrated as viewed from outside. Codes shown are for plain windows. Manufactured from 65mm aluminium extrusion. The first two numbers of code indicate approximate height, the last two numbers indicate approximate width.

Sash Style Options:

Standard option is:

Eg window code QPA0606

O indicates Ovolo sash style with Ovolo

Glazing Bar. Eg window code QOPA0606CL

T indicates Thermashield® double glazed sash

style. Eg window code QTPA0606

N indicates Sentinel sash style.

Eg window code QNPA0606

M indicates Acoustic sash style (SoundMizer®)

Eg window code QMPA0606

Bar Options:

CL indicates Colonial Bar.

Eg window code QPA0606CL

FED indicates Federation Bar.

Eg window code QPA0606FED

Configuration Options:

A indicates Awning

F indicates Fixed

AA indicates Awning\Awning

AF indicates Awning\Fixed

FA indicates Fixed\Awning

FF indicates Fixed\Fixed

AAA indicates Awning\Awning\Awning

AFA indicates Awning\Fixed\Awning

FAF indicates Fixed\Awning\Fixed

FFF indicates Fixed\Fixed\Fixed

T after the size indicates a Transom

General:

Black hardware is supplied as standard

No sill reveal to 2100 high windows

* Refer to Special Products on page 129 for Bar Layout Options

quantum[®] awning windows

STUD OPENING WINDOW		666	906	966	1146	1256	1626	1856	2226	2456	2706
		610	850	910	1090	1200	1570	1800	2170	2400	2650
656	600										
		QPA0606	QPA0608	QPA0609	QPA0611	QPA0612	QPAF0616	QPAF0618	QPAF0622	QPAFA0624	QPAFA0627
996	940										
		QPA0906	QPA0908	QPA0909	QPA0911	QPA0912	QPAF0916	QPAF0918	QPAF0922	QPAFA0924	QPAFA0927
1086	1030										
		QPA1006	QPA1008	QPA1009	QPA1011	QPA1012	QPAF1016	QPAF1018	QPAF1022	QPAFA1024	QPAFA1027
1256	1200										
		QPA1206	QPA1208	QPA1209	QPA1211	QPA1212	QPAF1216	QPAF1218	QPAF1222	QPAFA1224	QPAFA1227
1426	1370										
		QPA1406	QPA1408	QPA1409	QPA1411	QPA1412	QPAF1416	QPAF1418	QPAF1422	QPAFA1424	QPAFA1427
1856	1800										
		QPA1806T	QPA1808T	QPA1809T	QPA1811T	QPA1812T	QPAF1816T	QPAF1818T	QPAF1822T	QPAFA1824T	QPAFA1827T
2091	2035										
		QPA2106T	QPA2108T	QPA2109T	QPA2111T	QPA2112T	QPAF2116T	QPAF2118T	QPAF2122T	QPAFA2124T	QPAFA2127T
2091	2035										
		QPA2106	QPA2108								

notes

Hinged across the top, the sash of the Quantum XP[®] awning windows swings out from the bottom, giving your home good ventilation – even in wet weather. The sash design offers a wide viewing area, while its excellent sealing qualities ensure added climate control.

In gusty conditions, the sturdy chain winder mechanism prevents the window slamming.

* Also available in Colonial and Federation Bar styles.

The opposite page are window codes for Quantum XP[®] Premium products (55mm sash). For information on double-glazing or wind ratings, please contact Trend[®] Windows & Doors Sales Representative.

casement windows



make a statement

If you're planning to make a bold statement, Quantum XP® Casement windows may be precisely what you're looking for.

Their classic design brings character and romance to any home. Strong angular lines created by the premium 55mm sash gives a solid feel reminiscent of timber with all the strength and practicality of top quality aluminium.

features & benefits

- 1 Energy Efficiency Options
Trend® Thermashield® in various glazing styles are available to help reduce energy consumption. Trend® Thermashield® means greater control, bigger savings and most importantly one less thing to worry about. Energy efficient options to u-value of 5.9 and SHGC 0.25 are available for Quantum XP® Casement window.
- 2 Acoustic options
SoundMizer® acoustic solutions in various STC ratings, are available to STC 39 for Quantum XP® Casement window. SoundMizer® acoustic solutions can reduce aircraft, highway traffic, railway and other annoying noise problems. For information or technical details contact Trend®.
- 3 Operator
Quantum XP® Windows foldaway operator mechanism is designed for ease of operation and folds neatly into the housing when not in use. The arms are solid die-cast metal and the housing is coated in E-gard (Multi stage coating process that produces a greater, more durable finish). The robust mechanism is mounted securely to the window with concealed 6 point fixing. Operating handle is available in black or white only. Stainless steel arms are optional.
- 4 Side Sash Latch
Handle is operated by a 180° rotation from open to closed position and is concealed within the window frame. Operation pulls in sash for a tighter seal against the weather and improved security. Side sash latch is available in black or white only.
- 5 Opening
Casement allows a 90° opening for a wider viewing area and excellent ventilation control. The 90° opening makes it convenient for cleaning both sides of the sash.
- 6 Glazing
Quantum XP® Premium sash frames are available in 16mm double glazing for energy efficiency applications. Acoustic solutions are also available to high STC ratings.
- 7 Frame
Quantum XP® Casement frame is 65mm wide with a 55mm wide sash for greater strength and security. The sash has aesthetically pleasing lines and a smooth rounded profile that has a truly solid look. Reminiscent of timber, Quantum XP® Casement is extremely popular in both traditional and contemporary house designs.
 - Wind structurally rated to 1500Pa
 - Water pascals rated to 450Pa
 - Maximum sash height is 2035mm (Max height 2100)*
 - Maximum sash width is 850mm
 - Maximum sash width is 720mm for casement heights between 1800mm and 2035mm*
- 8 Window Placement
Care should be taken when locating opening casement windows in pedestrian traffic areas.
- 9 Protective Wrapping
Protective wrapping for delivery to site is a standard for all Quantum XP® products.
- 10 Options
Stainless steel hardware upgrade available.
Easy to fit flyscreens that can be removed from the inside.
Wide range of powdercoat finishes available including timber powdercoat finishes.
Also available in Colonial, Federation and Ovolo styles.

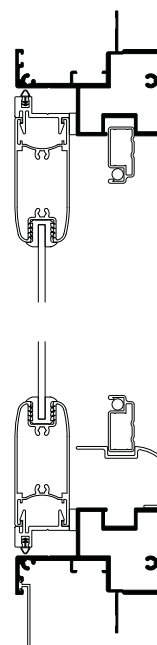

ordering details

All windows are illustrated as viewed from outside. Codes shown are for plain windows. Manufactured from 65mm aluminium extrusion. The first two numbers of code indicate approximate height, the last two numbers indicate approximate width.

Sash Style Options:

Standard option is:
Eg window code QPC0906
O indicates standard sash with Ovolo Glazing Bar. Eg window code QOPC0906CL
T indicates Thermashield® double glazed sash style. Eg window code QPTC0906

Bar Options:

CL indicates Colonial Bar.
Eg window code QPC0906CL
FD indicates Federation Bar.
Eg window code QPC0906FD

Configuration Options:

L indicates Left Hand Hinge
R indicates Right Hand Hinge
F indicates Fixed
LL indicates Left Hand\Left Hand
LR indicates Left Hand\Right Hand
LF indicates Left Hand\Fixed
RR indicates Right Hand\Right Hand
FR indicates Fixed\Right Hand

FF indicates Fixed\Fixed
LFR indicates Left Hand\Fixed\Right Hand
LLL indicates Left Hand\Left Hand\Left Hand
RRR indicates Right Hand\Right Hand\Right Hand
FLF indicates Fixed\Left Hand\Fixed
FRF indicates Fixed\Right Hand\Fixed
LRR indicates Left Hand\Right Hand\Right Hand
LLR indicates Left Hand\Left Hand\Right Hand
FFF indicates Fixed\Fixed\Fixed
T after the size indicates a Transom

* Refer to Special Products on page 129 for Bar Layout Options

quantum[®] casement windows

STUD OPENING WINDOW		666	776	906	1256	1626	1856	2226	2456	2706
		610	720	850	1200	1570	1800	2170	2400	2650
996	940									
1086	1030									
1256	1200									
1426	1370									
1856	1800									
2091	2035									
2091	2035									

notes

Quantum XP[®] Casement Windows is available in a Premium Sash featuring a substantial 55mm wide sash giving a strong and secure look reminiscent of timber. Ease of operation is facilitated by an operating mechanism specifically designed to fit and complement the Quantum XP[®] Casement window.

For information on double-glazing or wind ratings, please contact a Trend[®] Windows & Doors sales representative. Trend[®] Ovolo Individual Glazing Systems are available.

* Maximum sash width 720mm.

Also available in Federation and Colonial Bar styles.

* The opposite page are window codes for Quantum XP[®] Premium products (55mm frames)

sliding windows



slide into the future

With its patented Van Door sealing system the Quantum XP® sliding windows is the number one choice when quality matters, giving your home a premium look with clean uncluttered lines that perfectly frame a view or garden.

Quantum XP® sliding windows guarantee a first class lifestyle that makes the most of warm summer evenings or winter sun.

Extra durable double rollers ensure the aluminium frames always glide smooth and true.

features & benefits

- 1 Energy Efficiency Options
Trend® Thermashield® in various glazing styles are available to help reduce energy consumption. Trend® Thermashield® means greater control, bigger savings and most importantly one less thing to worry about. Energy efficient options to u-value of 4.7 and SHGC 0.39 are available for Quantum XP® Premium Sliding window.
- 2 Acoustic options
SoundMizer® acoustic solutions in various STC ratings, are available to STC 39 for Quantum XP® Premium Sliding window. SoundMizer® acoustic solutions can reduce aircraft, highway traffic, railway and other annoying noise problems. For information or technical details contact Trend®.
- 3 Security
Quantum XP® Premium Sliding Window is available with an optional concealed integral ventlock which allows the window to be deadlocked while partly open to allow for ventilation. Optional deadlock and fire egress features also available.
- 4 Fire Safety Egress
Fire egress security screen pin system available which allows for rapid removal of barrier screens in the event of an emergency.
- 5 Glazing
Quantum XP® Premium sash frames are available in 16mm double glazing for energy efficient applications. Acoustic solutions are also available to high STC ratings.
- 6 Frames
Quantum XP® Premium sash frame is 65mm with the window sash 55mm wide. Quantum XP® has a truly solid look that is reminiscent of timber and is extremely popular in both traditional and contemporary house designs.
- 7 Window Rollers
The Premium range uses a heavy duty dual wheel system for smooth operation.
- 8 Protective Wrapping
Protective wrapping for delivery to site is a standard for all Quantum XP® products.
- 9 Options
Easy to fit tension loaded flyscreens can be fitted and removed from the inside. Wide range of powdercoat finishes available including timber powdercoat finishes. Also available in Colonial, Federation and Ovolo styles.

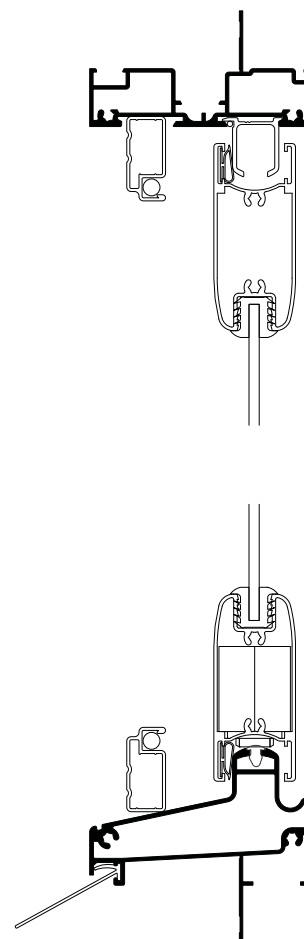

ordering details

All windows are illustrated as viewed from outside. Codes shown are for plain windows. Manufactured from 65mm aluminium extrusion & 55mm Sash material. The first two numbers of code indicate approximate height, the last two numbers indicate approximate width.

Sash Style Options:

Standard option is:

Eg window code QPSF0906

T indicates Thermashield® double glazed sash style. Eg window code QPTSF0906

M indicates Acoustic Option (SoundMizer®).
Eg window code QPMSF0906

Bar Options:

CL indicates Colonial Bar.

Eg window code QPSF0906CL

FED indicates Federation Bar.

Eg window code QPSF0906FED

Configuration Options:

SF indicates Sliding/Fixed

FS indicates Fixed/Sliding

SFS indicates Sliding/Fixed/Sliding

F indicated Fixed

T after the size indicates a Transom

* Refer to Special Products on page 129 for Bar Layout Options

quantum[®] premium sliding windows

		666	906	966	1146	1256	1626	1856	2226	2456	2706
		610	850	910	1090	1200	1570	1800	2170	2400	2650
STUD OPENING WINDOW	656										
	996										
	1086										
	1256										
	1426										
	1596										
	1856										
	2091										
	2035										

notes

For greater strength and security, Quantum XP[®] Windows are manufactured with a sturdy

65mm frame. Premium sash (55mm wide) has a truly solid look reminiscent of timber.

Also available in Ovolo, Colonial and Federation bar styles.

Vent locks are available but need to be requested on order.

For information on double-glazing or wind ratings, please contact a Trend[®] Windows & Doors sales representative.

sliding doors





strength of purpose

Want a better quality of life?

You'll appreciate the difference

Quantum® sliding doors

bring to your home.

Sturdy top quality construction and materials create one of the strongest sliding doors available.

Gliding smooth and true, blending outdoors seamlessly with indoors - these sliding walls of glass add a fresh dimension to any type of home from contemporary to more traditional designs.

Features include energy saving options, matching screen or barrier doors and a wide choice of colours.

features & benefits

- 1 Energy Efficiency Options
Trend® Thermashield® in various glazing styles are available to help reduce energy consumption. Trend® Thermashield® means greater control, bigger savings and most importantly one less thing to worry about. Energy efficient options to u-value of 3.0 and SHGC 0.41 are available for Quantum Sliding Door.
 - 2 Acoustic options
SoundMizer® acoustic solutions in various STC rating are available to STC 38 for Quantum Sliding Door. SoundMizer® acoustic solutions can reduce aircraft, highway traffic, railway and other annoying noise problems. For information or technical details contact Trend®.
 - 3 Locks
Sliding doors are fitted with double cylinder deadlock as standard
 - 4 Safety Glazing
Toughened Safety A Grade Glass with a visual motif at the mid point to provide added safety. Laminated Glass is used in all non standard door sizes.
18mm Double Glazing is available for energy efficiency requirements.
 - 5 Protected Rolling Track
An extruded aluminium splayed threshold protects both glass door and flydoor rolling tracks.
 - 6 Simple Access
The aluminium threshold features the Easyrider™ sill which is ideal for wheelchair access.
 - 7 Heavy Duty Rollers
Quantum door uses a heavy duty, double bogey roller system for smooth operation. The marine alloy aluminium carriage reduces the chance of corrosion ensuring a long and smooth operation.
 - 8 Frames
Quantum Door frame is 101.6mm wide with the sash 50mm wide. Reminiscent of timber, Quantum Sliding Door is extremely popular in both traditional and contemporary house designs.
- Maximum Door Height is 2700mm.
Maximum Door Panels 1500mm**
- 9 Interlockers
Five types of interlockers are available. Quantum Door rates to 2200 pascals (kPa) - structural.
 - 10 Optional Heavy Duty Barrier and Insect Screen Door
The sturdy extruded aluminium, external sliding flydoor is fitted with spring loaded acetal wheels that ensure the insect screen door stays on the track and opens smoothly.
 - 11 Build-In Accessories
 - 180° non-load-bearing couplers.
 - 135° non-load-bearing corner couplers.
 - 100mm aluminium architraves for replacement door installations.
 - Adjustable aluminium storm mould.
 - Extruded aluminium 180° mullion covers to hide load-bearing posts.
 - 12 Security
Quantum Sliding Door has a double parrot beak with a 2 point locking system. Striker plate is mounted with full fixing to jamb for added security.
 - 13 Protective Wrapping
Protective wrapping for delivery to site is optional for all Quantum sliding door product.
 - 14 Options
Colonial Bar, Federation Bar Layouts and Ovolo adaptor are available. Wide range of powdercoat finishes including timber finishes available.

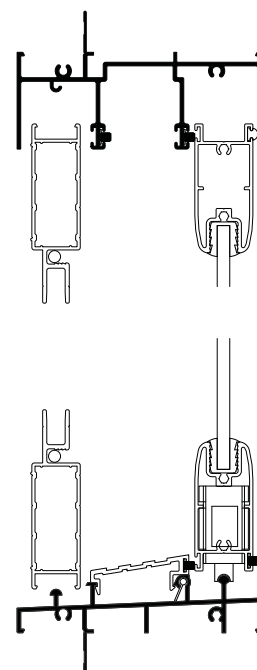

ordering details

All doors are illustrated as viewed from outside. Codes shown are for plain doors. The first two numbers of code indicate approximate height, the last two numbers indicate approximate width.

Sash Style Options:

Standard option is:
Eg door code QXD2118
O indicates ovolo sash style.
Eg door code QOXD2118
T indicates Thermashield® double glazed sash style. Eg door code QTXD2118
M indicates Acoustic sash style (SoundMizer®).
Eg door code QMXD2118
S indicates Sump Sill.
Eg door code QSXD2118

Bar Options:

CL indicates Colonial Bar.
Eg door code QXD2118CL
FD indicates Federation Bar.
Eg door code QXD2118FD

Configuration Options:

XF indicates Sliding/Fixed
FX indicates Fixed/Sliding
FXF indicates Fixed/Sliding/Fixed
FXXF indicates Fixed/Sliding/Sliding/Fixed

General:

Black hardware is supplied as standard
Two and Three panels doors available as reverse to brochure. Four panel doors have a prefix of QXXD.

* Also available in Colonial, Federation and Ovolo design styles.

Note:

Door heights not available in all wind pascal ratings. For information on double-glazing, different glass types or wind ratings, please contact a Trend® Windows & Doors sales representative. Pa refers to Pascal rating (wind pressure).

* Refer to Special Products on page 129 for Bar Layout Options

quantum® sliding doors

STUD OPENING	1626	1856	2226	2456	3066
	1570	1800	2170	2400	3010
DOOR SIZE					
2756 2456 2156 2700 2400 2100	QXD2116	QXD2118	QXD2122	QXD2124	QXD2130
	QXD2416	QXD2418	QXD2422	QXD2424	QXD2430
	QXD2716	QXD2718	QXD2722	QXD2724	QXD2730

STUD OPENING	2768	3323	3668
	2712	3267	3612
DOOR SIZE			
2756 2456 2156 2700 2400 2100	QXD2127	QXD2132	QXD2136
	QXD2427	QXD2432	QXD2436
	QXD2727	QXD2732	QXD2736

STUD OPENING	3624	4364	4824
	3568	4308	4768
DOOR SIZE			
2756 2456 2156 2700 2400 2100	QXXD2135	QXXD2143	QXXD2148
	QXXD2435	QXXD2443	QXXD2448
	QXXD2735	QXXD2743	QXXD2748

sliding stacker doors





a better way of living

Quantum XP® Stacker doors offer top quality Alfresco living.

Superior craftsmanship, materials and fittings ensure lasting good looks. These glide-away glass walls provide broad expanses of glass that let the light flow in but can also create a stylish outdoor room that lets you live expansively.

features & benefits

- 1 Energy Efficiency Options
Trend® Thermashield® in various glazing styles are available to help reduce energy consumption. Trend® Thermashield® means greater control, bigger savings and most importantly one less thing to worry about. Energy efficient options to u-Value of 3.0 and SHGC 0.41 are available for Quantum Sliding Stacker Door.
- 2 Acoustic options
SoundMizer® acoustic solutions in various STC rating are available to STC 38 for Quantum Sliding Stacker Door. SoundMizer® acoustic solutions can reduce aircraft, highway traffic, railway and other annoying noise problems. For information or technical details contact Trend®.
- 3 Locks
Sliding Stacker Doors are fitted with double cylinder deadlock as standard
- 4 Safety Glazing
Toughened Safety A Grade Glass with a visual motif at the mid point to provide added safety. Laminated Glass is used in all non standard door sizes. 18mm Double Glazing is available for energy efficiency requirements.
- 5 Protected Rolling Track
An extruded aluminium splayed threshold protects both glass door and flydoor rolling tracks.
- 6 Simple Access
The aluminium threshold features the Easyrider™ sill which is ideal for wheelchair access.
- 7 Heavy Duty Rollers
Quantum door uses a heavy duty, double bogey roller system for smooth operation. The marine alloy aluminium carriage reduces the chance of corrosion ensuring a long and smooth operation.
- 8 Frames
Quantum Door frame is 101.6mm wide with the sash 50mm wide. Reminiscent of timber, Quantum Sliding Stacker Door is extremely popular in both traditional and contemporary house designs.

Maximum Door Height is 2700mm
Maximum Door Width is 4473mm (up to 3 panel door)
Maximum Door Width is 6390mm (up to 6 panel door)
- 9 Interlockers
Five types of interlockers are available. Quantum Door rates to 2200 pascals (kPa) - structural.
- 10 Optional Heavy Duty Barrier and Insect Screen Door
The sturdy extruded aluminium, external sliding flydoor is fitted with spring loaded acetal wheels that ensure the insect screen door stays on the track and opens smoothly.
- 11 Build-In Accessories
 - 180° non-load-bearing couplers.
 - 135° non-load-bearing corner couplers.
 - 100mm aluminium architraves for replacement door installations.
 - Adjustable aluminium storm mould.
 - Extruded aluminium 180° mullion covers to hide load-bearing posts.
- 12 Security
Quantum Sliding Stacker Door has a double parrot beak with a 2 point locking system. Striker plate is mounted with full fixing to jamb for added security.
- 13 Protective Wrapping
Protective wrapping for delivery to site is optional for all Quantum Sliding Stacker Door product.
- 14 Options
Colonial Bar, Federation Bar Layouts and Ovolo adaptor are available. Wide range of powdercoat finishes including timber finishes available.

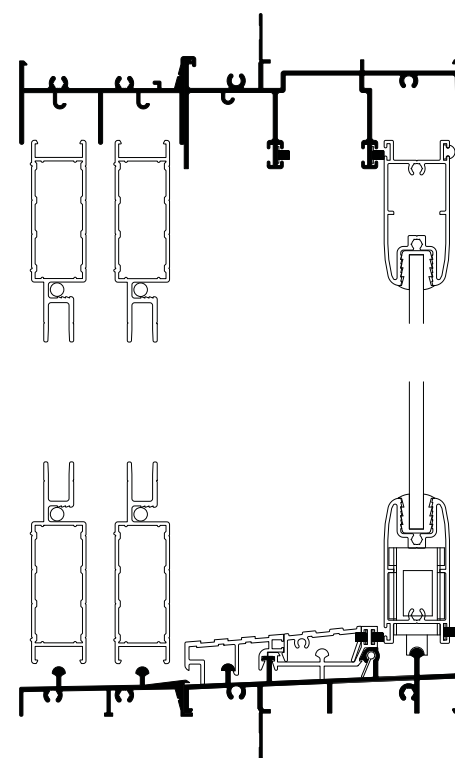

ordering details

All doors are illustrated as viewed from outside. Codes shown are for plain doors. The first two numbers of code indicate approximate height, the last two numbers indicate approximate width.

Sash Style Options:

Standard option is:
Eg door code QKXD2123
O indicates ovolo sash style.
Eg door code QOKXD2123
T indicates Thermashield® double glazed

sash style. Eg door code QTKXD2123
M indicates Acoustic sash style (SoundMizer®).
Eg door code QMKXD2123
S indicates Sump Sill.
Eg door code QSKXD2123

Bar Options:

CL indicates Colonial Bar.
Eg door code QKXD2123CL
FD indicates Federation Bar.
Eg door code QKXD2123FD

Configuration Options:

XXF indicates Slide/Slide/Fixed
FXX indicates Fixed/Slide/Slide
FXXXXF indicates Fixed/Slide/Slide/Slide/Slide/Fixed

General:

Black hardware is supplied as standard

* Refer to Special Products on page 129 for Bar Layout Options

quantum® sliding stacker doors

STUD OPENING DOOR SIZE	2369	2714	3269	3614	4529
	2313	2658	3213	3558	4473
2756 2456 2156 2700 2400 2100					
	QKXD2123	QKXD2126	QKXD2132	QKXD2135	QKXD2145
	QKXD2423	QKXD2426	QKXD2432	QKXD2435	QKXD2445
	QKXD2723	QKXD2726	QKXD2732	QKXD2735	QKXD2745

STUD OPENING DOOR SIZE	4646	5336	6446
	4590	5280	6390
2756 2456 2156 2700 2400 2100			
	QKXD2146	QKXD2153	QKXD2164
	QKXD2446	QKXD2453	QKXD2464
	QKXD2746	QKXD2753	QKXD2764

notes

Trend® Aluminium Stacker Doors modern bold clean lines and elegant styling offers uninterrupted views perfectly. Quality construction ensures ease of use, long life and security. All stacker doors are fitted with Grade A safety glass.

Door heights not available in all wind pascal ratings. For information on double-glazing, different glass types or wind ratings, please contact a Trend® Windows & Doors sales representative.

* Also available in Colonial, Federation and Ovolo design styles.

xtreme[®] quality for climate xtremes

We live in a changing world. Due to bushfires our living environment is becoming more extreme. In fact many homes lost to bush fires actually survive the main fire, only to fall victim to embers floating through shattered windows or doors.

That's why Trend has developed the Xtreme[®] range of aluminium windows and doors. They take the top quality Quantum range a step further – changing the design to protect Australian homes against the extremes of nature.

Featuring Pyro-Protec Seals with 5mm toughened glass, Xtreme[®] window systems are designed to withstand up to 40kw/m² of heat flux (CSIRO tested).

These are combined with our patented Van Door system which is a crucial element in helping a house survive a bushfire.

Xtreme[®] Windows & Doors are compliant to Section 8 Construction Service Bushfire Attack Level 40 (BAL-40), Radiant Heat Level 40kW/m², AS3959 (2009). For full details of Standards requirements for individual products please refer to Trend[®] Windows & Doors Technical Department.

It's a hard world out there - use Xtreme[®] to help your home tough it out.

xtreme[®]

Xtreme[®] Windows

Awning	91
Premium Sliding	95

Xtreme[®] Doors

Sliding	99
Hinged	103
Bifold	107

awning windows



stylish protection

Xtreme[®] awning windows help make the most of Australia's beautiful natural environment while protecting you from it at the same time.

Awning windows capture the breeze and give you plenty of space and light. Should the worst happen, close them up tight and they'll play a major part in helping your home survive.

Featuring Pyro-Protect™ Sealing and 5mm toughened glass, these windows are designed to withstand up to 40kw/m² of heat flux (CSIRO tested) – equivalent to an extreme bush fire, to help keep the house sealed against smoke and embers.



Winner
Design EX 2006
Product Design
Best New Product
Awards -
Surface Finishes



Winner
Australian Windows
Association 2006
Design Awards -
Most Innovative
Component

features & benefits

- 1 **Bushfire Features**
Xtreme® Bushfire Windows & Doors have been tested to withstand temperatures up to 40kWm² without failure from either the glazing or from the window system itself, to help prevent internal ignition of houses and loss of precious possessions.
- 2 **Xtreme® Bushfire Windows & Doors System**
Features include patented Van Door® and Pyro-Protect™ Sealing Systems acting to protect the home against wind, water, noise dust and bushfire penetration. Trend® has combined the technologically advanced Quantum XP® Windows system with Pyro-Protect™ seals, glazing systems and 5mm standard toughened glass to produce Xtreme® Windows and Doors.
- 3 **Energy Efficiency Options**
Trend® Thermashield® in various glazing styles are available to help reduce energy consumption. Trend® Thermashield® means greater control, bigger savings and most importantly one less thing to worry about. Energy efficient options to u-value of 4.4 and SHGC 0.42 are available for Xtreme® Awning window.
- 4 **Acoustic options**
SoundMizer® acoustic solutions in various STC ratings, are available to STC 31 for Xtreme® Bushfire Awning window. SoundMizer® acoustic solutions can reduce aircraft, highway traffic, railway and other annoying noise problems. For information or technical details contact Trend®.
- 5 **Key Lock Chain Winder**
Xtreme® Windows winder mechanism is designed specifically for high performance, security and reliability. With a Polesium™ cover and base can be combined with a stainless steel chain for long life and reliability, the XP winder can be used in even the harshest environment without worry of corrosion. The robust mechanisms are mounted securely to the window with a concealed 4 point fixing. Keyed lock is standard for added security.
- 6 **Continuous Hinge Hood**
The sash is protected from the weather by a continuous hinge hood that supports the sash and keeps the rain where it belongs - on the outside.
- 7 **Glazing**
Xtreme® Premium Awning sash frames have 5mm toughened glass as standard and is available in 6mm single and 16mm double glazing for energy efficiency applications. Acoustic solutions are also available to high STC ratings.
- 8 **Frames**
Xtreme® Bushfire Windows & Doors Premium frame is 65mm with the window sash 55mm wide. Xtreme® has a truly solid look, reminiscent of timber, and is extremely popular in both traditional and contemporary house designs.
- 9 **Window Placement**
Care should be taken with locating opening awning windows in pedestrian traffic areas.
- 10 **Protective Wrapping**
Protective wrapping for delivery to site is a standard for all Xtreme® products.
- 11 **Options**
Easy to fit flyscreens can be fitted and removed from the inside. Wide range of powdercoat finishes available including timber powdercoat finishes.

*Xtreme® Windows & Doors are compliant to Section 8 Construction Service Bushfire Attack Level 40 (BAL-40), Radiant Heat Level 40kW/m², AS3959 (2009). For full details of Standards requirements for individual products please refer to Trend Windows & Doors Technical Department.

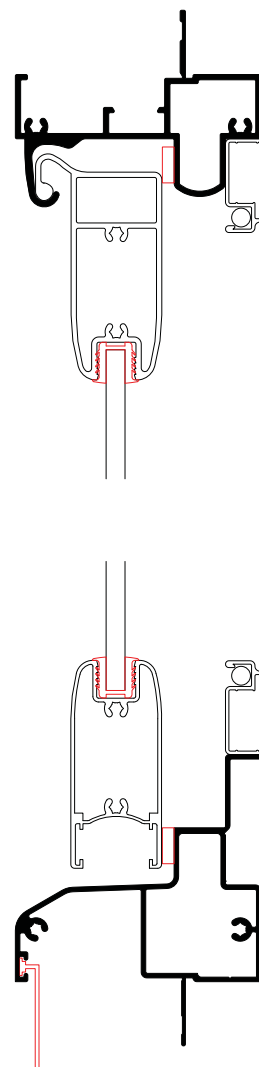

ordering details







































































All windows are illustrated as viewed from outside. Codes shown are for plain windows. Manufactured from 65mm aluminium extrusion. The first two numbers of code indicate approximate height, the last two numbers indicate approximate width.

Sash Style Options:
E indicates standard Xtreme Sash.
Eg window code QPA0906E

Configuration Options:
A indicates Awning
AF indicates Awning/Fixed

AA indicates Awning/Awning
AFA indicates Awning/Fixed/Awning
T after the size indicates a Transom

xtreme[®] awning windows

WINDOW		STUD OPENING									
		666	906	966	1146	1256	1626	1856	2226	2456	2706
		610	850	910	1090	1200	1570	1800	2170	2400	2650
656	600										
996	940										
1086	1030										
1256	1200										
1426	1370										
1856	1800										
2091	2035										

premium sliding windows



tough and sleek

Nature can be both beautiful and cruel. Xtreme[®] sliding windows are specifically built to handle both.

They open up your home to broad vistas and summer breezes while ensuring you have a high level of protection from bushfires.

Featuring Pyro-Protect™ Sealing and 5mm toughened glass, these windows are designed to withstand up to 40kw/m² of heat flux (CSIRO tested) – equivalent to an extreme bush fire. While our patented Van Door system keeps the house sealed against smoke and embers.



Winner
Design EX 2006
Product Design
Best New Product
Awards -
Surface Finishes



Winner
Australian Windows
Association 2006
Design Awards -
Most Innovative
Component

features & benefits

- 1 **Bushfire Features**
Xtreme® Bushfire Windows & Doors have been tested to withstand temperatures up to 40kW/m² without failure from either the glazing or from the window system itself, to help prevent internal ignition of houses and loss of precious possessions.
 - 2 **Xtreme® Bushfire Windows & Doors System**
Features include patented Van Door® and Pyro-Protect™ Sealing Systems acting to protect the home against wind, water, noise dust and bushfire penetration. Trend® has combined the technologically advanced Quantum XP Windows® system with Pyro-Protect™ seals glazing systems and 5mm standard toughened glass to produce Xtreme® Windows and Doors.
 - 3 **Energy Efficiency Options**
Trend® Thermashield® in various glazing styles are available to help reduce energy consumption. Trend® Thermashield® means greater control, bigger savings and most importantly one less thing to worry about. Energy efficient options to u-value of 4.0 and SHGC 0.46 are available for Xtreme® Sliding window.
 - 4 **Acoustic options**
SoundMizer® acoustic solutions in various STC ratings, are available to STC 31 for Xtreme® Bushfire Windows & Doors Sliding window. SoundMizer® acoustic solutions can reduce aircraft, highway traffic, railway and other annoying noise problems. For information or technical details contact Trend®.
 - 5 **Security**
Xtreme® Premium Sliding Window is available with an optional concealed integral ventlock which allows the window to be deadlocked while partly open to allow for ventilation. Optional deadlock and fire egress features are also available.
 - 6 **Fire Safety Egress**
Fire egress security screen pin system available which allows for rapid removal of barrier screens in the event of an emergency.
 - 7 **Glazing**
Xtreme® Premium sash frames have 5mm toughened glass as standard and is available in 6mm single and 16mm double glazing for energy efficiency applications. Acoustic solutions are also available to high STC ratings.
 - 8 **Frames**
Xtreme® Bushfire Windows & Doors Premium frame is 65mm with the window sash 55mm wide. Xtreme® has a truly solid look, reminiscent of timber, and is extremely popular in both traditional and contemporary house designs.
 - 9 **Window Rollers**
The Premium range uses a heavy duty, dual wheel system for smooth operation.
 - 10 **Protective Wrapping**
Protective wrapping for delivery to site is a standard for all Xtreme® products.
 - 11 **Options**
Easy to fit tension loaded flyscreens can be fitted and removed from the inside. Wide range of powdercoat finishes available including timber powdercoat finishes.
- *Xtreme® Windows & Doors are compliant to Section 8 Construction Service Bushfire Attack Level 40 (BAL-40), Radiant Heat Level 40kW/m², AS3959 (2009). For full details of Standards requirements for individual products please refer to Trend Windows & Doors Technical Department.

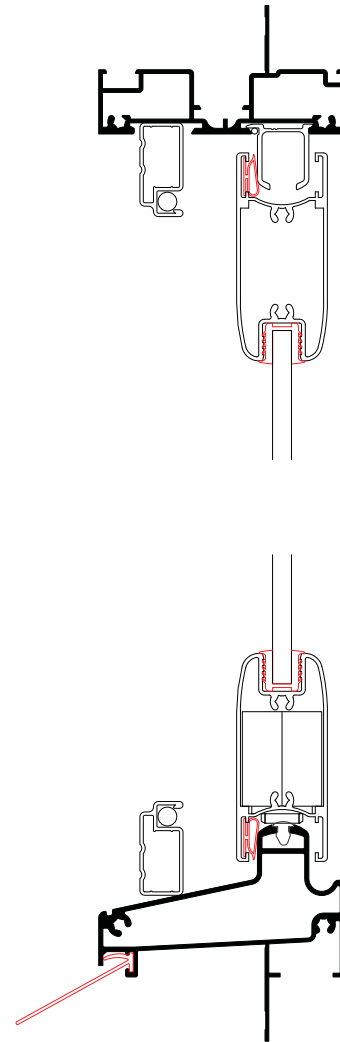

ordering details

















































































All windows are illustrated as viewed from outside. Codes shown are for plain windows. Manufactured from 65mm aluminium extrusion & 55mm Sash material. The first two numbers of code indicate approximate height, the last two numbers indicate approximate width.

Sash Style Options:
E indicates Xtreme Option.
Eg window code QPSF0906E

Configuration Options:
SF indicates Sliding/Fixed
FS indicates Fixed/Sliding

SFS indicates Sliding/Fixed/Sliding
F indicated Fixed
T after the size indicates a Transom

xtreme[®] premium sliding windows

STUD OPENING WINDOW	666	906	966	1146	1256	1626	1856	2226	2456	2706
	610	850	910	1090	1200	1570	1800	2170	2400	2650
656 600										
996 940										
1086 1030										
1256 1200										
1426 1370										
1696 1540										
1856 1800										
2091 2035										

sliding doors



ultimate safeguard

Xtreme[®] sliding doors open up your home to the best of your natural surroundings while protecting it against the worst.

Perfect for capturing bushy views, broad vistas and summer breezes they also give the highest levels of protection from bushfires.

Featuring Pyro-Protect™ Sealing and 5mm toughened glass designed to withstand up to 40kw/m² of heat flux (CSIRO tested) – equivalent to an extreme bush fire.



Winner
Design EX 2006
Product Design
Best New Product
Awards -
Surface Finishes



Winner
Australian Windows
Association 2006
Design Awards -
Most Innovative
Component

features & benefits

- 1 **Bushfire Features**
Xtreme® Bushfire Windows & Doors have been tested to withstand temperatures up to 40kW/m² without failure from either the glazing or from the window system itself, to help prevent internal ignition of houses and loss of precious possessions.
- 2 **Xtreme® Bushfire Windows & Doors System**
Features include patented Van Door® and Pyro-Protect™ Sealing Systems acting to protect the home against wind, water, noise dust and bushfire penetration. Trend® has combined the technologically advanced Quantum XP Windows® system with Pyro-Protect™ seals glazing systems and 6mm standard toughened glass to produce Xtreme® Windows and Doors.
- 3 **Energy Efficiency Options**
Trend® Thermashield® in various glazing styles are available to help reduce energy consumption. Trend® Thermashield® means greater control, bigger savings and most importantly one less thing to worry about. Energy efficient options to u-value of 3.6 and SHGC 0.57 are available for Xtreme® Sliding Door.
- 4 **Acoustic options**
SoundMizer® acoustic solutions in various STC rating are available to STC 28 for Xtreme® Sliding Door. SoundMizer® acoustic solutions can reduce aircraft, highway traffic, railway and other annoying noise problems. For information or technical details contact Trend®.
- 5 **Locks**
Sliding doors are fitted with a double cylinder deadlock as standard.
- 6 **Safety Glazing**
Toughened Safety A Grade Glass with a visual motif at the mid point to provide added safety. Double Glazing is available for energy efficiency requirements.
- 7 **Heavy Duty Rollers**
Xtreme® Sliding Door uses a heavy duty, dual wheel roller system for smooth operation. Glass door panels roll on heavy duty adjustable acetel wheels, that are perfectly matched to the sill rail to ensure efficient running.
- 8 **Frames**
Xtreme® Bushfire Sliding Door frame is 101.6mm wide with the sash 55mm wide. The sash has aesthetically pleasing lines and a smooth rounded profile that has a truly solid look. Reminiscent of timber, Xtreme® is extremely popular in both traditional and contemporary house designs.

Maximum Door Height is 2400mm.
Maximum Door Width is 4760mm (up to 4 panel door)
- 9 **Optional Heavy Duty Barrier and Insect Screen Door**
The sturdy extruded aluminium, external sliding barrier door is fitted with dual lock that ensure the safety and security while opening.
- 10 **Build-In Accessories**
 - 180° non-load-bearing couplers.
 - 135° non-load-bearing corner couplers.
 - 100mm aluminium architraves for replacement door installations.
 - Adjustable aluminium storm mould.
 - Extruded aluminium 180° mullion covers to hide load-bearing posts.
- 11 **Security**
Xtreme® Sliding Door has a double parrot beak with a 2 point locking system. Striker plate is mounted with full fixing inside jamb for added security.
- 12 **Protective Wrapping**
Protective wrapping for delivery to site is a standard for all Xtreme® products.
- 13 **Options**
Wide range of powdercoat finishes including timber finishes available.

*Xtreme® Windows & Doors are compliant to Section 8 Construction Service Bushfire Attack Level 40 (BAL-40), Radiant Heat Level 40kW/m², AS3959 (2009). For full details of Standards requirements for individual products please refer to Trend Windows & Doors Technical Department.

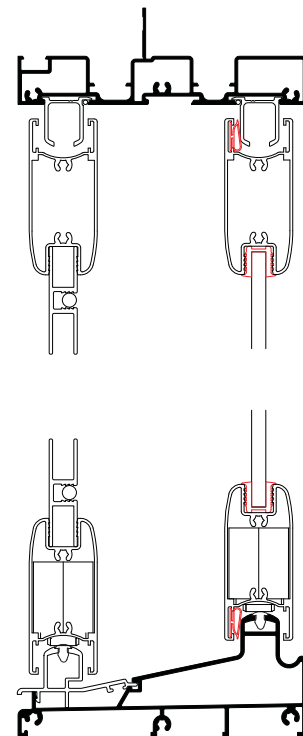

General:

Two and Three panels doors available as reverse to brochure
Four panel doors have a prefix of QPFXF

ordering details

All doors are illustrated as viewed from outside. Codes shown are for plain doors.

The first two numbers of code indicate approximate height, the last two numbers indicate approximate width.





Sash Style Options:



E indicates Xtreme sash style.
Eg door code QPXF2118E

Configuration Options:

XF indicates Sliding/Fixed
FX indicates Fixed/Sliding
FXF indicates Sliding/Fixed/Sliding
FXXF indicates Fixed/Sliding/Sliding/Fixed

xtreme[®] sliding doors

STUD OPENING	1626	1856	2226	2456
	DOOR SIZE	1570	1800	2170
2456 2156				
	2400 2100	QPXF2116E QPXF2416E	QPXF2118E QPXF2418E	QPXF2122E QPXF2422E

STUD OPENING	2761	3316	3661
	DOOR SIZE	2705	3260
2456 2156			
	2400 2100	QPFXF2127E QPFXF2427E	QPFXF2132E QPFXF2432E

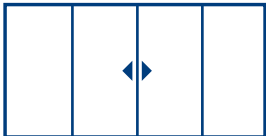
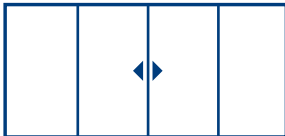
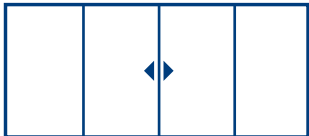
STUD OPENING	3616	4356	4816
	DOOR SIZE	3560	4300
2456 2156			
	2400 2100	QPFXFXF2135E QPFXFXF2435E	QPFXFXF2143E QPFXFXF2443E

hinged doors



more than a door

Xtreme[®] hinged doors give a warm welcome for friends and family while ensuring there's no way in for a bushfire.

They not only look great they perform to the highest standards. Pyro-Protect[™] Sealing, 5mm toughened glass and strong aluminium frames are designed to withstand up to 40kw/m² of heat flux (CSIRO tested) – equivalent to an extreme bush fire.



Winner
Design EX 2006
Product Design
Best New Product
Awards -
Surface Finishes



Winner
Australian Windows
Association 2006
Design Awards -
Most Innovative
Component

features & benefits

- 1 Bushfire Features
Xtreme® Bushfire Windows & Doors have been tested to withstand temperatures up to 40kW/m² without failure from either the glazing or from the window system itself, to help prevent internal ignition of houses and loss of precious possessions.
- 2 Xtreme® Bushfire Windows & Doors System
Features include Pyro-Protect™ Sealing Systems acting to protect the home against wind, water, noise dust and bushfire penetration. Trend® has combined the hinged door with Pyro-Protect™ glazing seals systems with 6mm standard toughened glass to produce Xtreme® Hinged Doors.
- 3 Energy Efficiency Options
Trend® Thermashield® in various glazing styles are available to help reduce energy consumption. Trend® Thermashield® means greater control, bigger savings and most importantly one less thing to worry about. Energy efficient options to u-value of 6.0 and SHGC 0.27 are available for Trend® Xtreme® Bushfire Hinged Door.
- 4 Acoustic options
SoundMizer® acoustic solutions in various STC ratings, are available to STC 27 for Trend® Xtreme® Bushfire Hinged Door. SoundMizer® acoustic solutions can

reduce aircraft, highway traffic, railway and other annoying noise problems. For information or technical details contact Trend®.

- 5 Safety Glazing
Toughened Safety A Grade Glass with a visual motif at the mid point to provide added safety. Double Glazing is available for energy efficiency requirements.
- 6 Locks
Standard patio deadlock is fitted for security. Optional three point locking is also available.
- 7 Hinges
The door is hung on special offset fast-fix hinges to eliminate binding. The door can also be supplied with Parliament hinges where the door is to swing out flush to brickwork.
- 8 Direction of Opening
The door can only be ordered as open out both in single and double doors only.
- 9 Drained Sill
Standard on the door is the fully drained sill to improve the weathering on the door.
- 10 Protective Wrapping
Protective wrapping for delivery to site is a standard for all Xtreme® products.

- 11 Options
Wide range of powdercoat finishes including timber finishes available.

*Xtreme® Windows & Doors are compliant to Section 8 Construction Service Bushfire Attack Level 40 (BAL-40), Radiant Heat Level 40kW/m², AS3959 (2009). For full details of Standards requirements for individual products please refer to Trend Windows & Doors Technical Department.

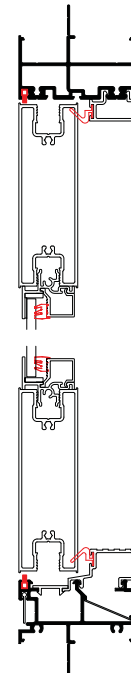

ordering details

All doors are illustrated as viewed from outside. Codes shown are for plain doors.

The number in the code indicates width of the frame to suit either a 620, 720 or 820 door. AP Indicates Aluminium Provincial Door.

When specifying door type, firstly select frame size. Eg AP898

Select door style by placing the code after the frame size. Eg AP898/FL

Opening

OI indicates door Opens In. Eg AP898/FL-OI
OO indicates doors Opens Out.
Eg AP898/FL-OO

Sash Style Options:

E indicates Xtreme sash style.
Eg door code AP898/CR-OI E

General:

Black hardware is supplied as standard

Notes:

- AP indicates Aluminium Provincial Door.
- 1) When specifying door type, firstly select frame size, eg AP898
 - 2) Select door type by placing a code after frame size, eg AP898/FL E
Code: E = Xtreme® Bushfire Product

xtreme[®] hinged doors

STUD OPENING DOOR SIZE	854	954	1377	1577	1777
		798	898	1321	1521

2174 2118 OI & OO					
	AP798 E	AP898 E	AP1321 E	AP1521 E	AP1721 E

DOORS

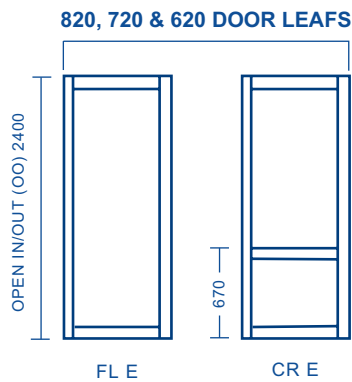

notes

All windows and doors are designed to 700pa wind velocity and 150pa water rating.

For higher ratings consult Trend[®] Windows & Doors sales personnel.

AP indicates Aluminium Provincial Door.

1) When specifying door type, firstly select frame size, eg AP898

2) Select door type by placing a code after frame size, eg AP898/FL E
Code: E = Xtreme[®] Bushfire Product

bifold doors



beat the heat

Xtreme[®] bi-fold doors also perform a two-fold job. First they add style - opening up living areas to views and cool breezes.

At the same time they also provide high levels of protection from bushfires. So you can enjoy the best of indoor outdoor living knowing that the indoors is protected from the worst of the outdoors.

Pyro-Protect[™] Sealing and 5mm toughened glass helps these doors withstand up to 40kw/m² of heat (CSIRO tested) – equivalent to an extreme bush fire. Helping keep the house sealed against smoke and embers.



Winner
Design EX 2006
Product Design
Best New Product
Awards -
Surface Finishes



Winner
Australian Windows
Association 2006
Design Awards -
Most Innovative
Component

features & benefits

1 Bushfire Features

Xtreme® Bushfire Windows & Doors have been tested to withstand temperatures up to 40kW/m² without failure from either the glazing or from the window system itself, to help prevent internal ignition of houses and loss of precious possessions.

2 Xtreme® Bushfire Windows & Doors System

Features include Pyro-Protect™ Sealing Systems acting to protect the home against wind, water, noise dust and bushfire penetration. Trend® has combined the technologically advanced Quantum Windows® system with Pyro-Protect™ glazing seal system with 6mm standard toughened glass to produce Xtreme® Bifold Doors.

3 Energy Efficiency Options

Trend® Thermashield® in various glazing styles are available to help reduce energy consumption. Trend® Thermashield® means greater control, bigger savings and most importantly one less thing to worry about. Energy efficient options to u-value of 4.0 and SHGC 0.52 are available for Trend® Xtreme® Bifold Door.

4 Acoustic options

SoundMizer® acoustic solutions in various STC ratings, are available to STC 26 for Trend® Xtreme® Bifold Door. SoundMizer® acoustic solutions can reduce aircraft, highway traffic, railway and other annoying noise problems. For information or technical details contact Trend®.

5 Door Hardware

Stainless steel hardware is provided as standard. Door hardware, hinges and drop bolts are available in three finishes, stainless steel, gold and black powder coat.

6 Safety Glazing

Toughened Safety A Grade Glass with a visual motif at the mid point to provide added safety. Double Glazing is available for energy efficiency requirements.

7 Frames

The weight of the bifold doors must be considered in the structural beam calculation of the overall structure. The bifold door and frame are not structural elements and the head of the frame should be attached to the structural beam.

Maximum Frame Height is 2400mm
Maximum Frame Width is 6065mm
Maximum Door Leaf Size is 870mm
Maximum Weight in one direction is 180kg

8 Protective Wrapping

Protective wrapping for delivery to site is a standard for all Xtreme® products.

9 Options

Wide range of powdercoat finishes including Timber finishes available.

NOTE: Available open out only.

*Xtreme® Windows & Doors are compliant to Section 8 Construction Service Bushfire Attack Level 40 (BAL-40), Radiant Heat Level 40kW/m², AS3959 (2009). For full details of Standards requirements for individual products please refer to Trend Windows & Doors Technical Department.

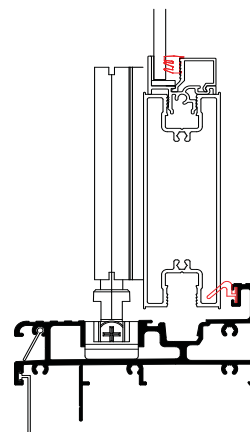
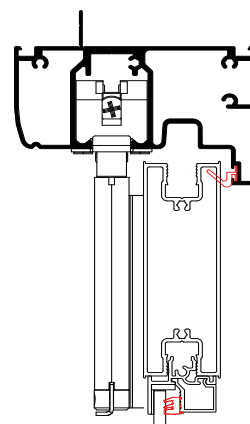

ordering details

All doors are illustrated as viewed from outside. Codes shown are for plain windows.

The first two numbers of code indicate approximate height, the last two numbers indicate approximate width.

Sash Style Options:

E indicates Xtreme sash style.
Eg door code ABF2214/2LE

Configuration Options:

Configuration is shown at the end of the code.
Eg door code ABF2220/1L2R (1Left, 2Right)

notes





































The weight of the bifold doors must be considered in the structural beam calculation of the overall structure.

The bifold door and frame are not structural elements and the head of the frame should be attached to the structural beam.

Available open out only.

Maximum frame height 2400mm.
Max door leaf size 870mm.
Max frame width is 6062mm.
Max weight in one direction 180kg.

xtreme[®] bifold system

STUD OPENING DOOR		FRAME WIDTH + 56mm	Frame Width	Leaf Directions	Leaf #	Door Code
FRAME HEIGHT + 56mm 2165 STANDARD HEIGHT 2400 MAX. HEIGHT	2 PANELS 1800 MAX. WIDTH	1388		2L	ABF2214/2L E	
		1588		2R	ABF2216/2L E	
		1788		2R	ABF2218/2L E	
	3 PANELS 2700 MAX. WIDTH	2043		3L	ABF2220/3L E	
		2343		3R	ABF2223/3L E	
		2643		3R	ABF2226/3L E	
		2046		2L 1R	ABF2220/2L1R E	
		2346		1L 2R	ABF2223/2L1R E	
		2646		1L 2R	ABF2226/2L1R E	
	4 PANELS 3500 MAX. WIDTH	2700		3L 1R	ABF2220/1L2R E	
		3100		1L 3R	ABF2223/1L2R E	
		3500		1L 3R	ABF2226/1L2R E	
		2696		2L 2R	ABF2227/3L1R E	
		3096		4L	ABF2227/3L1R E	
		3496		4R	ABF2227/1L3R E	
				4R	ABF2231/1L3R E	
				4R	ABF2235/1L3R E	
	5 PANELS 4400 MAX. WIDTH	3350		5L	ABF2227/2L2R E	
		3860		2L 2R	ABF2231/2L2R E	
		4360		4L	ABF2235/2L2R E	
3360			4L 1R	ABF2227/4L E		
3860			4L	ABF2231/4L E		
4360			4R	ABF2235/4L E		
3355			3L 2R	ABF2227/4R E		
3855			4R	AB2231/4R E		
4355			4R	ABF2235/4R E		
5 PANELS 4400 MAX. WIDTH	3350		5L	ABF2234/5L E		
	3860		5L	ABF2239/5L E		
	4360		5L	ABF2244/5L E		
	3360		5R	ABF2234/5R E		
	3860		5R	ABF2239/5R E		
	4360		5R	ABF2244/5R E		
	3360		4L 1R	ABF2234/4L1R E		
	3860		4L 1R	ABF2239/4L1R E		
	4360		4L 1R	ABF2244/4L1R E		
	3360		1L 4R	ABF2234/1L4R E		
	3860		1L 4R	ABF2239/1L4R E		
	4360		1L 4R	ABF2244/1L4R E		

features & benefits

- 1 **Bushfire Features**
Xtreme® Bushfire Windows & Doors have been tested to withstand temperatures up to 40kW/m² without failure from either the glazing or from the window system itself, to help prevent internal ignition of houses and loss of precious possessions.
- 2 **Xtreme® Bushfire Windows & Doors System**
Features include Pyro-Protect™ Sealing Systems acting to protect the home against wind, water, noise dust and bushfire penetration. Trend® has combined the technologically advanced Quantum Windows® system with Pyro-Protect™ glazing seal system with 6mm standard toughened glass to produce Xtreme® Bifold Doors.
- 3 **Energy Efficiency Options**
Trend® Thermashield® in various glazing styles are available to help reduce energy consumption. Trend® Thermashield® means greater control, bigger savings and most importantly one less thing to worry about. Energy efficient options to u-value of 4.0 and SHGC 0.52 are available for Trend® Xtreme® Bifold Door.
- 4 **Acoustic options**
SoundMizer® acoustic solutions in various STC ratings, are available to STC 27 for Trend® Xtreme® Bifold Door. SoundMizer® acoustic solutions can reduce aircraft, highway traffic, railway and other annoying noise problems. For information or technical details contact Trend®.
- 5 **Door Hardware**
Stainless steel hardware is provided as standard. Door hardware, hinges and drop bolts are available in three finishes, stainless steel, gold and black powder coat.
- 6 **Safety Glazing**
Toughened Safety A Grade Glass with a visual motif at the mid point to provide added safety. Double Glazing is available for energy efficiency requirements.
- 7 **Frames**
The weight of the bifold doors must be considered in the structural beam calculation of the overall structure. The bifold door and frame are not structural elements and the head of the frame should be attached to the structural beam.
- 8 **Protective Wrapping**
Protective wrapping for delivery to site is a standard for all Xtreme® products.
- 9 **Options**
Wide range of powdercoat finishes including Timber finishes available.

Maximum Frame Height is 2400mm
Maximum Frame Width is 6065mm
Maximum Door Leaf Size is 870mm
Maximum Weight in one direction is 180kg

NOTE: Available open out only.

*Xtreme® Windows & Doors are compliant to Section 8 Construction Service Bushfire Attack Level 40 (BAL-40), Radiant Heat Level 40kW/m², AS3959 (2009). For full details of Standards requirements for individual products please refer to Trend Windows & Doors Technical Department.

ordering details

All doors are illustrated as viewed from outside. Codes shown are for plain windows.

The first two numbers of code indicate approximate height, the last two numbers indicate approximate width.

Sash Style Options:
E indicates Xtreme sash style.
Eg door code ABF2214/2LE

Configuration Options:
Configuration is shown at the end of the code.
Eg door code ABF2220/1L2R (1Left, 2Right)

notes

The weight of the bifold doors must be considered in the structural beam calculation of the overall structure.





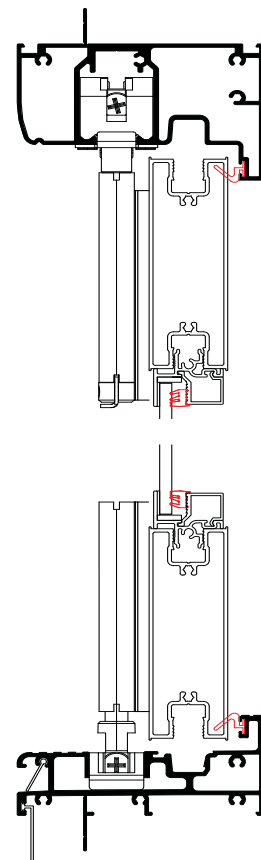

The bifold door and frame are not structural elements and the head of the frame should be attached to the structural beam.

Available open out only.

Maximum frame height 2400mm.
Max door leaf size 870mm.
Max frame width is 6062mm.
Max weight in one direction 180kg.



xtreme[®] bifold system

FRAME WIDTH + 56mm		Frame Width	Leaf Directions	Leaf #	Door Code	
STUD OPENING DOOR	6 PANELS 5300 MAX. WIDTH	4002		6L	ABF2240/6L E ABF2246/6L E ABF2252/6L E	
		4602		6R	ABF2240/6R E ABF2246/6R E ABF2252/6R E	
		5202		4L 2R	ABF2240/4L2R E ABF2246/4L2R E ABF2252/4L2R E	
				2L 4R	ABF2240/2L4R E ABF2246/2L4R E ABF2252/2L4R E	
		7 PANELS 6065 MAX. WIDTH	4008		3L 3R	ABF2240/3L3R E ABF2246/3L3R E ABF2252/3L3R E
					5L 1R	ABF2240/5L1R E ABF2246/5L1R E ABF2252/5L1R E
	1L 5R				ABF2240/1L5R E ABF2246/1L5R E ABF2252/1L5R E	
	4653			7L	ABF2247/7L E ABF2253/7L E ABF2261/7L E	
				7R	ABF2247/7R E ABF2253/7R E ABF2261/7R E	
						5L 2R
	2165 STANDARD HEIGHT 2400 MAX. HEIGHT	4662		2L 5R	ABF2247/2L5R E ABF2254/2L5R E ABF2261/2L5R E	
				4L 3R	ABF2247/4L3R E ABF2254/4L3R E ABF2261/4L3R E	
6062					3L 4R	ABF2247/3L4R E ABF2254/3L4R E ABF2261/3L4R E
		1L 6R	ABF2247/1L6R E ABF2254/1L6R E ABF2261/1L6R E			
		6L 1R	ABF2247/6L1R E ABF2254/6L1R E ABF2261/6L1R E			

crestlite®



commercial breakthrough

As Australia's largest supplier of windows and doors with nine factories across the country Trend® is uniquely positioned to offer complete façade systems for shopfronts, factories, high rises and speciality residential projects with its Crestlite® range.

Trend® Crestlite® offers top quality aluminium commercial framing custom built to your design. Specialities include large area glazing solutions - emphasising thermal efficiency to reduce building running costs.

While employee and customer safety is ensured with the latest EH&S policies followed to the letter.

Trend® Crestlite® can provide a total solution from design through to installation and certification. No job is too small and everything we do meets AS3900 quality specifications.

Simply give us a call to discuss your ideas.

crestlite[®]



commercial & semi commercial

The Crestlite® range of products features commercial and semi commercial windows and doors for residential, shopfront, factories, high-rise and apartments.

Crestlite® offset frames can have any of the Trend® range of operable windows inserted into the frame in either single or double-glazed.

The Trend® Commercial division specialises in offering a complete facade system, supply, installation and certification. Trend® has the capacity and experience

to offer all aluminium glazing, glass and aluminium louvres and toughened glass assemblies.

Trend® operates with a quality system equal to AS3900 and recognises the need to prepare project specific quality plans as well as maintaining up to date EH&S policies in accordance with the required industry codes of practice.

For further information on Crestlite® products, contact your local Trend® sales office.

thermashield®



energy efficiency

All Trend® Windows & Doors products in the Thermashield® range are rated to WERS (Windows Energy Rating Scheme) which is approved by The AFRC (Australian Fenestration Rating Council) the only recognised body in Australia for energy rating windows and doors.

The NFRC (National Fenestration Rating Council) also recognises the above ratings when determining energy requirements.



Member #M0418



putting energy efficiency first ...

The only thing predictable about the weather is that it can and will exert an impact on your comfort and lifestyle.

When it comes to battling the heat and cold, energy efficient double glazing and low-e glass can offer significant savings by reducing expensive energy bills. When it comes to reducing carbon footprints and helping create a better environment, you cannot go past Trend® Windows & Doors Thermashield®.

Windows and doors which utilise the technologically advanced properties of the Thermashield® system offer a much more precise way to shield yourself and others from weather extremes.

Thermashield® also makes it easy for you to evaluate the level of protection you require for each specific window and door, and to choose accordingly. In turn, this translates into cost savings by reducing heating and cooling bills.

All Trend® Windows & Doors products in the Thermashield® range are rated to WERS (Windows Energy Rating Scheme) which is approved by The AFRC (Australian Fenestration Rating Council) the only recognised body in Australia for energy rating windows and doors.

The NFRC (National Fenestration Rating Council) also recognises the above ratings when determining energy requirements.

Thermashield® means greater control, bigger savings and, most importantly, one less thing to worry about.

Thermashield® putting CLIMATE CONTROL together

Find out more today.



energy efficiency starts at home

To get the best energy savings and the most comfort, different windows and doors are required for different climates.

For simplicity's sake, these are:

Cold climates, where the largest energy load is in heating the home. Melbourne, Hobart, Tamworth and Canberra are typical cold climates.

Hot climates, where the largest energy load is in cooling the home. Brisbane, Cairns and Darwin are typical hot climates.

Mixed climates, where the energy load is similar for heating and cooling. Sydney, Adelaide and Perth are typical mixed climates.

In order to make the best choice of window or door for your home, you also need to weigh up factors like u-Value and SHGC. Air Infiltration is also important to think about when considering windows and doors, as this is a major source of heat gain and loss. The lower the u-Value, the more effective it is at preventing heat transfer (in or out) of a window. The u-Value is a measure of the rate of non-solar heat loss or gain through any given product.

To prevent heat gain, the lower a window's Solar Heat Gain Coefficient (SHGC), the less heat enters a home from solar radiation. The SHGC is a number between 0 and 1 which represents the fraction of solar radiation admitted through a window, including what is absorbed and subsequently released inward.

Sunlight can fade and degrade many organic materials, like carpet, fabrics, paper, artwork, paints and wood. The main offender is ultraviolet radiation, which is the most energy intensive and thus most likely to break chemical bonds. Window and glass selection can influence the type and intensity of transmitted radiation.

With Trend® Thermashield®, in cold climate areas it is now possible to have lower heat loss, less air leakage, and warmer window surfaces that improve comfort and minimise condensation. u-Values that are lower (around 1.5-2.3) provide excellent performance.

Homes that require significant heating with older style (single-glazed) windows are a major source of unwanted heat loss, discomfort, and condensation problems. They feel colder because more heat is radiated from a person's body to the glass, which is at a much lower temperature. Cold glass also creates uncomfortable drafts, as air next to the window is cooled and drops to the floor.

With Trend® Thermashield®, in hot climate areas you can significantly reduce solar heat gain and improve comfort while retaining clear views and daylight.

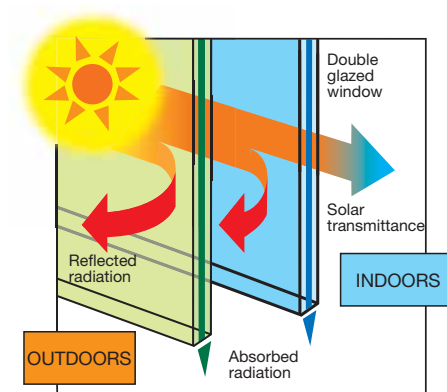
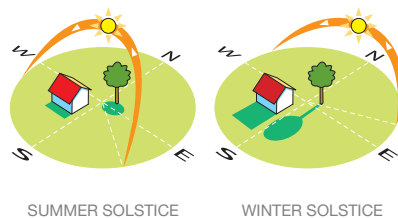



When strong direct sunlight strikes interior surfaces, it creates overheating and discomfort. Windows with low solar heat gain low-e glass (spectrally selective) can reduce this effect, while still providing light and view. Shading of windows is also very effective. Trend® Thermashield® window cooling options are recommended here. In these areas the lower the SHGC (Around 0.5 or lower) the better protection from solar radiation heating the home.

In most climates, savings can be improved even further by substituting glass with a near-invisible low emissivity (or 'low-e') coating. However, while a low-e coating on simple single glazing reduces that part of the heat transfer, it does nothing to reduce conductive and convective heat flow. A much better solution is to reduce all three forms of heat transfer. To do this, you need an insulating glass unit (IGU or double-glazing).

The most common filling gas between the panes of an IGU is dry air. The narrowest air gap used is 6mm, but

wider gaps (10-20mm) will improve the performance. For even greater performance, the IGU should have a low-e coating on at least one pane and argon gas fill between the panes. Correct installation around windows and doors will also improve comfort by reducing cold air leakage.

High-performance windows systems like Trend® Thermashield® make homes more comfortable, reduce annual energy bills, and lessen peak heating and cooling loads. This means you can use a smaller heating or cooling system. It's also much easier on the environment. Trend® Thermashield® frames with low thermal conductivity and low air infiltration complemented by energy efficient glass balances the entire window system.

Trend® Thermashield® means greater control, bigger savings and, most importantly, one less thing to worry about.



protection from extremes

COLD CLIMATE

In climates where the largest energy load is in heating the home, the following Thermashield® window options are recommended.

We have listed your options broadly from 2 to 7½ stars (the stars to the far left of the table). The more stars, the more protection from the cold.

THERMASHIELD HEATING SYSTEM								
STAR RATING	PRODUCT	ID CODE NUMBER	Glazing	U Value	SHGC	HEATING % IMPROVEMENT	COOLING % IMPROVEMENT	
★★	Trend Aluminium Sliding Door	TND-017-03	5mm Gry	6.4	0.54	8	30	
	Quantum Sliding Door	TND-017-03	5mm Gry	6.4	0.54	8	30	
	Trend Aluminium Sliding Window	TND-001-11	12.38mm Lam	6.3	0.57	10	28	
★★★	Quantum Sliding Door	TND-017-05	6.38mm Lam	6.3	0.7	17	15	
	Xtreme Bifold Door	TND-022-01	5mm Clr Toughen	6.0	0.59	17	28	
	Trend Aluminium Double Hung Window	TND-020-01	3mm Clr	6.3	0.75	18	10	
★★★★	Trend Aluminium Sliding Window	TND-001-08	6.38mm CP	4.7	0.44	25	46	
	Trend Aluminium Hinged Door	TND-021-06	6.38mm CP Gry	4.5	0.36	25	52	
	Trend Aluminium Sliding Door	TND-017-07	6.38mm CP Gry	4.6	0.43	27	47	
★★★★★	Trend Aluminium Sliding Window	TND-001-16	4mm Gry / 10 Ar / 4mm Clr	4.2	0.46	32	47	
	Trend Aluminium Bifold Door	TND-026-02	4mm Gry / 10 Ar / 4mm Clr	4.0	0.38	32	53	
	Quantum Sliding Window	TND-004-14	4mm Gry / 8 Ar / 4mm	4.1	0.46	35	46	
★★★★★★	Trend Aluminium Bifold Door	TND-026-01	4mm Clr / 10 Ar / 4mm Clr	4.0	0.52	39	44	
	Trend Aluminium Sliding Window	TND-001-14	4mm Clr / 10 / 4mm EA	3.7	0.54	41	43	
	Quantum Sliding Window	TND-004-18	3mm Clr / 10 Ar / 3mm Clr	4.1	0.59	41	37	
★★★★★★★	Quantum Sliding Window	TND-004-15	4mm / 8 Ar / 4mm EA	3.5	0.54	45	44	
	Xtreme Sliding Door	TND-006-04	5mm Clr Tgn / 6 / 5mm Low E Tgn	3.6	0.57	45	42	
	Trend Aluminium Sliding Door	TND-017-09	4mm Clr / 10 Ar / 4mm Clr	3.8	0.62	46	36	
★★★★★★★★	Quantum Sliding Window	TND-004-19	3mm Clr / 10 / 3mm EA	3.4	0.55	47	44	
	Quantum Awning Window	TND-005-14	4mm Clr / 8 Ar / 4mm Clr	4.5	0.51	52	42	
	Trend Aluminium Sliding Door	TND-017-11	4mm Clr / 10 Ar / 4mm EA	3.0	0.59	53	43	
★★★★★★★★★	Meranti Awning Window	TND-010-09	6.38mm CP Gry	3.1	0.33	59	61	
	Cedar Casement Window	TND-008-08	6.38mm CP	3.2	0.36	60	59	
	Trend Aluminium Awning Window	TND-002-15	4mm Clr / 10 Ar / 4mm Clr	4.1	0.57	61	39	
★★★★★★★★★★	Cedar Awning Window	TND-007-16	4mm Gry / 6 / 4mm Clr	2.8	0.37	64	60	
	Trend Aluminium Awning Window	TND-002-17	4mm Clr / 10 Ar / 4mm EA	3.5	0.53	66	45	
	Synergy uPVC Casement Window	TND-013-12	6 Caribia / 14 Ar / 4mm EA	1.9	0.23	66	74	
★★★★★★★★★★★	Synergy Casement Window	TND-013-07	4mm Gry / 17 Ar / 4mm EA	1.9	0.28	69	70	
	Cedar Awning Window	TND-007-10	3mm Clr / 8 / 3mm Clr	2.8	0.51	73	50	
	Meranti Awning Window	TND-010-10	3mm Clr / 8 / 3mm Clr	2.8	0.51	73	50	
★★★★★★★★★★★★	Meranti Casement Window	TND-011-11	4mm Clr / 12 Ar / 4mm Clr	2.5	0.51	75	51	
	Synergy uPVC Awning Window	TND-013-01	4mm / 16 / 4mm EA	2.0	0.47	78	57	
	Synergy uPVC Casement Window	TND-013-01	4mm / 16 / 4mm EA	2.0	0.47	78	57	
★★★★★★★★★★★★★	Meranti Awning Window	TND-010-13	4mm Clr / 12 Ar / 4mm EA	1.9	0.47	79	57	
	Cedar Casement Window	TND-008-13	4mm Clr / 12 Ar / 4mm EA	2.0	0.48	80	56	
	Synergy uPVC Casement Window	TND-013-05	4mm / 17 Ar / 4mm EA	1.9	0.47	80	57	



protection from extremes

HOT CLIMATE

In climates where the largest energy load is in cooling the home, the following Thermashield® window options are recommended.

We have listed your options broadly from 2 to 6 stars (the stars to the far left of the table). The more stars, the more protection from the heat.

THERMASHIELD COOLING SYSTEM							
STAR RATING	PRODUCT	ID CODE NUMBER	Glazing	U Value	SHGC	COOLING % IMPROVEMENT	HEATING % IMPROVEMENT
★★	Quantum Awning Window	TND-005-04	5mm Gry	6.4	0.44	37	23
	Trend Aluminium Sliding Window	TND-001-20	5mm Clr / 10 / 4mm Clr	4.3	0.57	38	36
	Trend Aluminium Double Hung Window	TND-029-01	4mm Clr / 10 / 4mm Clr	4.1	0.58	38	38
★★☆	Quantum Awning Window	TND-005-02	4mm EA	5.4	0.43	43	37
	Trend Aluminium Awning Window	TND-002-14	4mm Clr / 10 / 4mm EA	3.7	0.53	44	64
	Trend Aluminium Bifold Door	TND-026-01	4mm Clr / 10 Ar / 4mm Clr	4.0	0.52	44	39
★★★	Quantum Sliding Door	TND-017-10	4mm Gry / 10 Ar / 4mm Clr	3.8	0.46	49	38
	Trend Aluminium Awning Window	TND-002-13	4mm Gry / 10 / 4mm Clr	4.2	0.42	50	52
	Quantum Sliding Window	TND-004-10	6.38mm CP Gry	4.7	0.39	50	24
★★★★☆	Trend Aluminium Sliding Window	TND-001-18	4mm Gry / 10 Ar / 4mm EA	3.5	0.42	53	38
	Quantum Casement Window	TND-023-06	6.38mm CP Gry	5.9	0.25	53	20
	Trend Aluminium Awning Window	TND-002-18	4mm Gry / 10 Ar / 4mm EA	3.5	0.41	54	60
★★★★★	Trend Aluminium Sliding Door	TND-017-12	4mm Gry / 10 Ar / 4mm EA	3.0	0.41	56	44
	Quantum Sliding Door	TND-017-12	4mm Gry / 10 Ar / 4mm EA	3.0	0.41	56	44
	Trend Aluminium Bifold Door	TND-026-04	4mm Gry / 10 Ar / 4mm EA	3.4	0.34	59	36
★★★★★☆	Synergy uPVC Awning Window	TND-013-09	5mm Gry / 14 Ar / 5mm	2.4	0.33	64	67
	Synergy uPVC Casement Window	TND-013-09	5mm Gry / 14 Ar / 5mm	2.4	0.33	64	67
	Synergy uPVC Sliding Door	TND-014-11	6 Caribia / 14 Ar / 4mm	2.6	0.33	64	45
★★★★★★	Cedar Double Hung Window	TND-025-07	5mm Gry / 6 Ar / 5mm EA	2.2	0.34	65	49
	Synergy uPVC Sliding Door	TND-014-04	4mm Gry / 17 Ar / 4mm EA	1.9	0.35	66	53
	Synergy uPVC Casement Window	TND-013-11	6 Caribia / 14 Ar / 4mm	2.4	0.26	69	63
★★★★★★☆	Synergy uPVC Awning Window	TND-013-07	4mm Gry / 17 Ar / 4mm EA	1.9	0.28	70	69
	Synergy uPVC Casement Window	TND-013-07	4mm Gry / 17 Ar / 4mm EA	1.9	0.28	70	69
	Synergy uPVC Sliding Door	TND-014-12	6 Caribia / 14 Ar / 4 EA	1.9	0.28	70	49
★★★★★★★	Synergy uPVC Awning Window	TND-013-12	6 Caribia / 14 Ar / 4mm EA	1.9	0.23	74	66
	Synergy uPVC Casement Window	TND-013-12	6 Caribia / 14 Ar / 4mm EA	1.9	0.23	74	66
	Synergy uPVC Casement Window	TND-013-14	6 Solarcool Gry / 14 Ar / 4mm	2.4	0.19	74	57

MIXED CLIMATE

In climates where the energy load for both heating and cooling the home are similar, the following Thermashield® window options are recommended.

THERMASHIELD MIXED SYSTEM								
STAR RATING	PRODUCT	ID CODE NUMBER	Glazing	U Value	SHGC	COOLING % IMPROVEMENT	HEATING % IMPROVEMENT	
★★	Trend Aluminium Double Hung Window	TND-029-01	4mm Clr / 10 / 4mm Clr	4.1	0.58	38	38	
	Quantum Sliding Window	TND-004-18	3mm Clr / 10 Ar / 3mm Clr	4.1	0.59	37	41	
	Quantum Sliding Door	TND-017-06	6.38mm CP	4.6	0.63	31	37	
★★★☆☆	Trend Aluminium Sliding Window	TND-001-17	4mm Clr / 10 Ar / 4mm EA	3.5	0.55	43	44	
	Trend Aluminium Double Hung Window	TND-029-03	4mm Clr / 10 / 4mm EA	3.6	0.54	44	43	
	Trend Aluminium Awning Window	TND-002-14	4mm Clr / 10 / 4mm EA	3.7	0.53	44	64	
★★★★	Trend Aluminium Bifold Door	TND-026-03	4mm / 10 Ar / 4mm EA	3.4	0.49	49	44	
	Quantum Sliding Window	TND-004-15	4mm / 8 Ar / 4mm EA	3.5	0.54	44	45	
	Trend Aluminium Awning Window	TND-002-13	4mm Gry / 10 / 4mm Clr	4.2	0.42	50	52	
★★★★★☆☆	Quantum Sliding Window	TND-004-16	4mm Gry / 8 Ar / 4mm EA	3.5	0.42	53	39	
	Quantum Awning Window	TND-005-17	4mm Gry / 8 Ar / 4mm EA	4.0	0.38	54	51	
	Trend Aluminium Awning Window	TND-002-18	4mm Gry / 10 Ar / 4mm EA	3.5	0.41	54	60	
★★★★★★	Trend Aluminium Sliding Door	TND-017-12	4mm Gry / 10 Ar / 4mm EA	3.0	0.41	56	44	
	Quantum Sliding Door	TND-017-12	4mm Gry / 10 Ar / 4mm EA	3.0	0.41	56	44	
	Meranti Awning Window	TND-010-12	4mm Gry / 12 Ar / 4mm Clr	2.5	0.39	60	69	
★★★★★★★☆☆	Synergy uPVC Casement Window	TND-013-09	5mm Gry / 14 Ar / 5mm	2.4	0.33	64	67	
	Cedar Casement Window	TND-008-14	4mm Gry / 12 Ar / 4mm EA	2.0	0.37	64	74	
	Meranti Casement Window	TND-011-14	4mm Gry / 12 Ar / 4mm EA	2.0	0.37	64	74	
★★★★★★★★	Synergy uPVC Sliding Door	TND-014-04	4mm Gry / 17 Ar / 4mm EA	1.9	0.35	66	53	
	Synergy uPVC Awning Window	TND-013-11	6 Caribia / 14 Ar / 4mm	2.4	0.26	69	63	
	Cedar Awning Window	TND-007-14	4mm Gry / 12 Ar / 4mm EA	1.9	0.36	65	73	
★★★★★★★★★☆☆	Synergy uPVC Sliding Door	TND-014-12	6 Caribia / 14 Ar / 4mm EA	1.9	0.28	70	49	
	Synergy uPVC Awning Window	TND-013-07	4mm Gry / 17 Ar / 4mm EA	1.9	0.28	70	69	
	Synergy uPVC Casement Window	TND-013-07	4mm Gry / 17 Ar / 4mm EA	1.9	0.28	70	69	
★★★★★★★★★★	Synergy uPVC Casement Window	TND-013-14	6 Solarcool Gry / 14 Ar / 4mm	2.4	0.19	74	57	
	Synergy uPVC Awning Window	TND-013-12	6 Caribia / 14 Ar / 4mm EA	1.9	0.23	74	66	
	Synergy uPVC Casement Window	TND-013-12	6 Caribia / 14 Ar / 4mm EA	1.9	0.23	74	66	

soundmizer[®]



combat the noise

With the constant need to combat extremes of noise, windows and doors can often be the weakest link in the isolation of noise from outside a home.

Since sound is energy, effective barriers must have mass and density and a low resonant frequency to stop or reflect the energy.

Trend® SoundMizer® products are high performance, acoustic options designed to minimise troublesome noise.

Trend® understands this requirement. Efficient acoustic management starts with the SoundMizer® collection from Trend®.

Solutions up to rW 43 can be achieved with single and secondary glazing elements for any noisy environment.

For details of individual test results, consult the Trend® Sales Executive in your area or call 13 72 74 to be transferred to the nearest sales office.

trend[®] acoustic STC/Rw ratings chart

Primary Windows & Doors

Acoustic STC/Rw Rating	Trend [®] Awning Window	Trend [®] Sliding Door Maximum Panel Weight 80kgs	Trend [®] Sliding Window Maximum Sash Weight 44kgs	Trend [®] Double Hung Window	Trend [®] /Crestlite [®] Fixed Window	Trend [®] Hinged Door Maximum Panel Weight 40kgs	Trend [®] Bifold Door Maximum Panel Weight 40kgs
24	✓	✓	✓	✓	✓	✓	✓
25	✓	✓	✓	✓	✓	✓	✓
26	✓	✓	✓	✓	✓	✓	✓
27	✓	✓	✓	✓	✓	✓	✓
28	✓	✓	✓	✓	✓	✓	✓
29	✓	✓	✓	✓	✓	✓	✓
30	✓	✓	✓	✓	✓	✓	✓
31	✓	✓	✓	✓	✓	✓	✓
32	✓	✓	✓	✓	✓	✓	✓
33	✓	✓	✓	✓	✓	✓	✓
34	✓	✓	✓	✗	✓	✓	✓
35	✓	✓	✓	✗	✓	✓	✓
36	✓	✓	✓	✗	✓	✗	✗
37	✓	✓	✗	✗	✓	✗	✗
38	✓	✓	✗	✗	✓	✗	✗
39	✓	✗	✗	✗	✓	✗	✗

Secondary Windows & Doors

Acoustic STC/Rw Rating	Quantum® Awning Window	Quantum® Sliding Window
24	✓	✓
25	✓	✓
26	✓	✓
27	✓	✓
28	✓	✓
29	✓	✓
30	✓	✓
31	✓	✓
32	✓	✓
33	✓	✓
34	✓	✓
35	✓	✓
36	✓	✓
37	✓	✓
38	✓	✓
39	✓	✓

Acoustic STC/Rw Rating	Trend® Awning Window	Trend® Sliding Door Maximum Panel Weight 80kgs	Trend® Sliding Window Maximum Sash Weight 44kgs	Quantum® Sliding Window
37	✓	✓	✓	✓
38	✓	✓	✓	✓
39	✓	✓	✓	✓
40	✓	✓	✓	✓
41	✓	✓	✓	✓
42	✓	✓	✓	✓
43	✓	✓	✓	✓
44	✓	✓	✓	✓
45	✓	✓	✓	✓
46	✓	✓	✓	✓



For details of individual test results, consult the Trend® Sales Executive in your area or call 137274 to be transferred to the nearest sales office

special products

The only limit is imagination.
Do it your way.

Are you looking for grand expanse
of glass to run the entire length of
a waterfront apartment? A uniquely
glazed archway to give a house
extra character?

Perhaps you want round windows
or there's a particular tint or colour
you have in mind.

At Trend® we'll work with you
to design and build exactly the
window or windows you have in
mind. All you have to do is ask.

federation bar layouts

DOUBLE HUNG WINDOWS

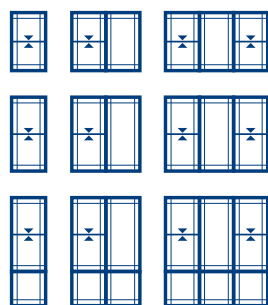

AWNING WINDOWS

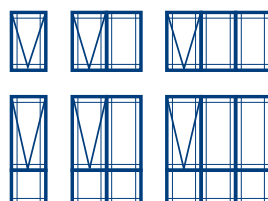

CASEMENT WINDOWS

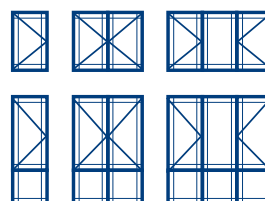

SLIDING WINDOWS

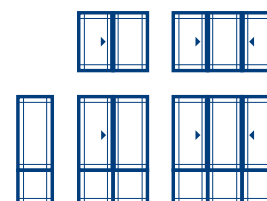

BAY DOUBLE HUNG & SLIDING WINDOWS

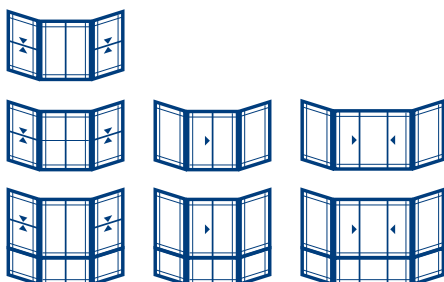

SLIDING DOORS

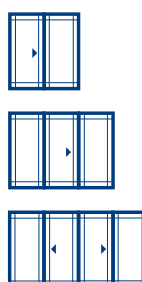

SLIDING WINDOWS

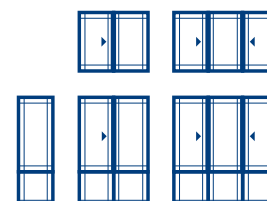

customised windows

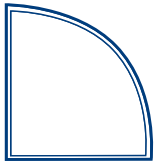

QUARTER ROUND

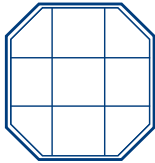

HEXAGONAL

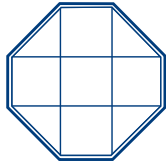

OCTAGONAL

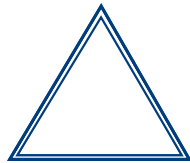

TRIANGULAR

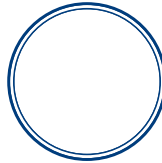

PORTHOLE

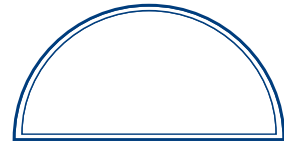

HALF ROUND

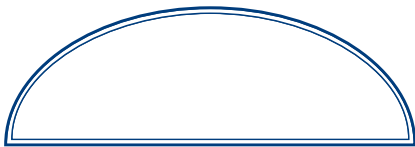

SEGMENTED HEAD

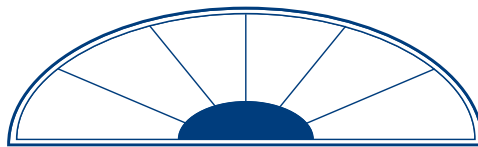

ELLIPTICAL HEAD - CEDAR ONLY

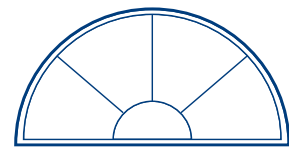

HALF ROUND COLONIAL

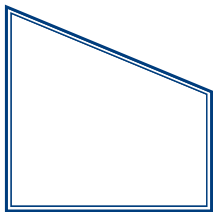

RAKED 1

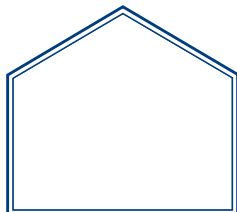

RAKED 2

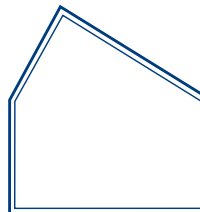

RAKED 3

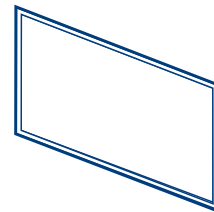

OBLIQUE

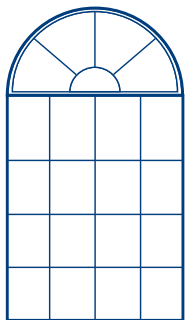

QUARTER ROUND LONG

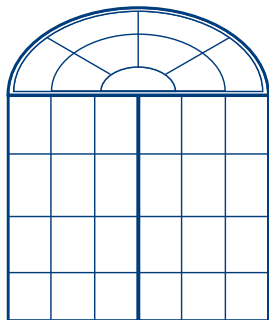

EXTERIOR QUARTER ROUND

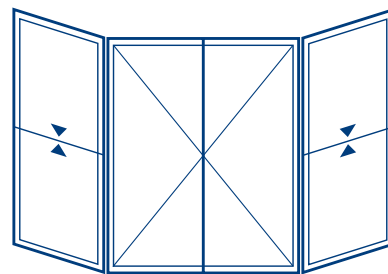

135° BAY

ovolo glazing bar



the individual touch

Trend's unique Ovolo glazing bar system combines the classic colonial style characteristics of small individual panes of glass with all the functionality of modern aluminium. Ideal for creating that Federation 'timber framed' feeling Ovolo glazing is an option on most types of Trend[®] windows as well as sliding and hinged doors.



OPTIONAL OVOLO
GLAZING BAR



Compliance Certificate

*Trend Windows and Doors is a participating member of the **AWA Accreditation Program**, a **7 year Guarantee** against faulty workmanship and materials, (subject to TWD's warranty clause in our terms and conditions of sale) is committed to the **Industry Code of Practice** and has met the requirements of the annual **AWA Compliance Audit** conducted by a **NATA** accredited audit.*

*This certifies that at the time of delivery, the windows and / or doors supplied by Trend Windows and Doors Pty Limited to the address site below were manufactured and glazed in accordance with **Australian Standards AS2047 - 1999 and AS1288 - 2006** to suit the nominated design wind pressures of: pa as per details supplied to Trend Windows and Doors Pty Limited at the time of order.*

Trend Windows and Doors Pty Limited accepts no responsibility for the installation of windows and / or doors.

Please note that windows and / or doors must be installed in the nominated locations for which they are designed, in accordance with the window industry and manufactures guidelines and recognized building practices. The installation of windows and / or doors shall be carried out so that the requirements of AS2047 - 1999 and AS1288 - 2006 are satisfied.

Builder

Address/Lot No

MACS #

*Signed for and on behalf of
Trend Windows & Doors*

Date



Accreditation No. 13739

This inspection service is accredited by the National Association of Testing Authorities Australia. The service reported herein have been performed in accordance with the scope of accreditation



installation instructions

Ensure the correct glass type and window rating has been specified for the particular application.

When fixing frames follow these simple steps:

1. Fit flashing to window surround as required. *Refer Trend® Installation Detail*
2. Frame must be packed plumb, square and not twisted between the opening. Ensure the sill is fully supported, failure to do so may result in sill roll on sliding windows.
3. Secure aluminium windows by nailing through reveal. Timber windows should be secured by back nailing through stud, not face of frame to stud. Alternatively, on cavity brick construction use galvanised building lugs located at 450mm maximum centres.
4. Keep sash closed whilst installing frames.
5. Sill bricks should be at least 15mm clear of window frame to allow for settlement.
6. Do not stand on the windows, or use them as a support for scaffolding, or slide material through the frame.
7. Do not permit weight of eaves or arch bars to bear on aluminium or timber frames.
8. Remove cement mortar dropping from windows immediately, taking care to avoid scratching glass and frames, as permanent damage can result.

No guarantee will be given if aluminium painted surfaces come into contact with acid when cleaning brickwork. Refer Terms and Conditions of Sale for full details.

NOTE: The aluminium sill and outside brick skin must be separated with an isolator to prevent possible reaction between brick and mortar and the aluminium frame which can lead to crevice corrosion.

The sill must be level side to side and front to back and fully supported during and after construction.

window ratings

All Trend® Windows are made to meet Australian Standards regulations AS2047 and AS1288.

These standards relate to the glass type, wind pressure and water penetration ratings of the window. However, as weather conditions vary it is essential that the correct window rating or design wind speed for the specific location be supplied to Trend® Windows & Doors prior to quoting and manufacture. This is further explained in AS2047.

The applicant for building approval or the approving authority shall nominate the window rating appropriate to the location of the building.

The minimum rating for each wind classification and a guide to the design wind pressure are set out in AS2047.

The minimum rating for housing is set out in AS2047.1, and the design window pressure for buildings other than housing shall be established appropriate to the location of the building.

Information on determining the window rating specification is available from AS4055, the Australian Window Association or Trend® Windows & Doors.

Compliance to Standards:

It is important to ensure that a valid compliance certificate is obtained for presentation to certifier/regulator to prove compliance to BCA and AS codes. An example of this is shown opposite.

care & maintenance

On site, windows and doors should be stored in a clean dry area free from cement, lime, paint, acid etc.

During installation they must be protected from building fall-out such as wet plaster, mortar, paint and welding splatter.

Remove wet plaster, cement, mortar and other droppings immediately, using ample clean water and a sponge or rag, to avoid permanent staining or scratching of finished surfaces.

If removal is delayed and scraping becomes necessary the surface finish may suffer. Door tracks and window sills should be protected from planks, scaffolding and barrows, and kept clean of grit and dirt.

Acid used for cleaning brickwork must be prevented from dripping onto aluminium or timber surfaces. Should this fail the acid must be immediately washed off with ample clean water.

If stripable coatings or pressure sensitive tapes are used to protect exposed surfaces, care must be taken not to damage the finish during their removal. Prolonged exposure to sunlight can make them increasingly difficult to remove.

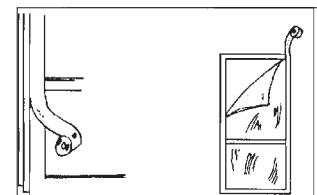
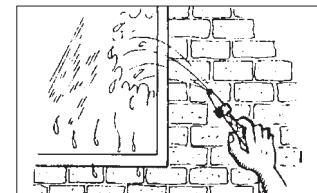
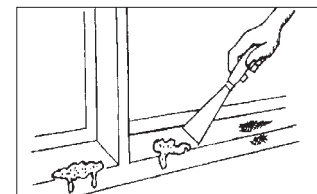
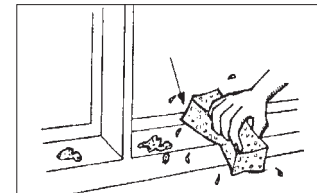
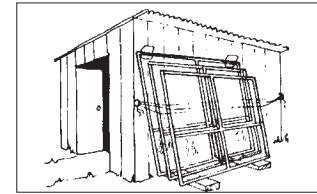

maintenance conditions

1. All powdercoated surfaces should be cleaned using a soft cloth or sponge with a solution of warm water. Where the atmosphere is deemed to be non-hazardous eg. rural, the period between cleaning frequency can be extended up to twelve months. In industrial environments or environments with atmospheric pollution the normal frequency of cleaning should be at not more than three monthly intervals. However where there is high atmospheric pollution, such as a marine/coastal environment, cleaning should be conducted at monthly intervals.
2. Remove cement mortar dropping from windows immediately, taking care to avoid scratching glass and frames,

as permanent damage can result. Trend® Windows & Doors will not be liable for any damage that may occur if the timber or aluminium painted surfaces come into contact with acid when cleaning brickwork.

3. Timber products **MUST BE** sealed (within one (1) month of delivery) with two coats of paint, varnish or sealer to both faces and edges including top and bottom. Exterior quality finishes in light reflective colours (not DARK colours) must be applied to all products exposed to direct sunlight or the elements.

guarantee

- a) The benefits conferred by guarantees herein are in addition to all other rights and remedies in respect of the goods or services of which a consumer has under the Trade Practices Act ("the Act") and similar State and Territory laws.
- (b) Trend® Windows & Doors guarantees the product(s) supplied against defects arising from faulty workmanship or materials for a period of seven years (12 months for moving hardware and parts) from date of delivery and guarantees that services will be rendered with due care and skill. These guarantees shall be effective provided the following general and specific warranty conditions are complied with:-
- (i) The product is installed and maintained in accordance with the manufacturer's and/or the Australian Window Association - industry recommendations where applicable, and has not been subject to misuse, abuse or neglect.
 - (ii) Timber products are to be sealed (within one (1) month of delivery) with two coats of paint. Varnish or sealer to both faces and edges including top and bottom. Exterior quality finishes in light reflective colours (NOT dark colours) must be applied to all products exposed to direct sunlight or the elements.
 - (iii) All solid construction timber doors must be hung with three (3) 100mm hinges.
 - (iv) A warp in a door will not be considered a defect unless it exceeds 5mm.
 - (v) Aluminium product surfaces which have been treated with a powdercoat finish provide a much higher resistance to scratching or scuffing and protects against normal weather conditions; however Trend® Windows & Doors does not warrant against fading or colour change due to normal weather conditions which will cause any coloured surface to fade or darken gradually.
- (c) The Customer's attention is drawn to Section 68A of the Act which has the effect of enabling suppliers in respect of contracts for the supply of goods or services not being goods or services of a kind ordinarily acquired for personal, domestic or household use or consumption to limit their liability in certain circumstances for breach of certain of the conditions and warranties implied by the Act.
- (d) Conditional upon the goods or services provided by Trend® Windows & Doors not being of a kind ordinarily acquired for personal, domestic or household use or consumption and subject to any specific warranty or condition set forth herein and any warranty as to title implied by Section 69 of the Act and provided that in the circumstances it is fair and reasonable the liability of the Company is limited.
- (a) In the case of goods, any one of the following as determined by Trend® Windows & Doors:-
 - (i) the replacement of the goods or the supply of equivalent goods; or
 - (ii) the repair of goods; or
 - (iii) the refund of moneys paid;
 - (b) In the case of services, one of the following as determined by Trend® Windows & Doors:-
 - (i) the supplying of the services again; or
 - (ii) the refund of moneys paid
 If the goods or services supplied are not in accordance with the warranties then the Customer will advise the Company in writing to replace or repair the goods, resupply the services or make the payment as the case may be.
- (e) To the full extent permitted by law, but subject always to the above terms, all conditions and warranties not expressly contained herein are hereby expressly negated and excluded.
- (f) Subject to 8(c) and (d) above, Trend® Windows & Doors liability for any breach of contract or for any negligent act or omission is limited to the cost of replacement of the goods or supply of equivalent goods and shall not extend to consequential loss, loss of profits or any liability for damage to property or death of or injury to persons howsoever caused.
- (g) If the goods or services provided by the Company are acquired for personal, domestic or household use and are not of merchantable quality or fit for the particular purpose advised by the Customer to Trend® Windows & Doors or in accord with a description or sample given by Trend® Windows & Doors to the Customer or free from any legal restriction on ownership then the Customer shall have the right to return the goods and claim a refund; and may be entitled to consequential damages.

other trend® products

contact your nearest sales office for other Trend® brochures



*western red cedar
range selector*



*meranti
range selector*



*energy efficiency
thermashield®*



*crestlite® commercial
range selector*

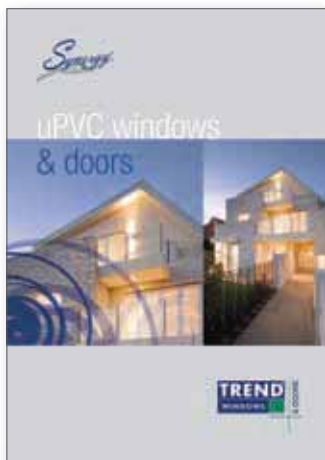

*synergy® uPVC
windows & doors*



*xtreme® bushfire
technical manual*

contact trend® windows & doors

SYDNEY

HEAD OFFICE
44-52 Mandoon Road,
Girraween NSW 2145
Tel: (02) 9840 2000
Fax: (02) 9840 2100

3/384 Eastern Valley Way,
Chatswood 2067
Tel: (02) 9882 1155
Fax: (02) 9882 1566

WOLLONGONG

Tel: (02) 4256 1966
Fax: (02) 4256 3863

NOWRA

Unit 1A, 175 Princes Highway
South Nowra NSW 2541
Tel: (02) 4423 1500
Fax: (02) 4423 5100

NEWCASTLE

56-60 Munibung Road,
Cardiff NSW 2285
Tel: (02) 4956 7133
Fax: (02) 4956 9146

OURIMBAH

5 Catamaran Road,
Ourimbah NSW 2258
Tel: (02) 4389 1402
Fax: (02) 4389 8460

PORT MACQUARIE

2/11 Blackbutt Road,
Port Macquarie NSW 2444
Tel: (02) 6581 5100
Fax: (02) 6581 4056

TAMWORTH

7-11 Hume Street,
Tamworth NSW 2340
Tel: (02) 6765 4066
Fax: (02) 6765 2584

DUBBO

1/55 Douglas Mawson Drive,
Dubbo NSW 2830
Tel: (02) 6884 4055
Fax: (02) 6884 4057

ACT

74 Sheppard Street,
Hume ACT 2620
Tel: (02) 6260 1266
Fax: (02) 6260 1381

VICTORIA

92 Canterbury Road,
Bayswater North VIC 3153
Tel: (03) 9751 7000
Fax: (03) 9751 7010

36 Oliphant Way,
Seaford VIC 3198
Tel: (03) 9770 8888
Fax: (03) 9775 1811

72-74 Main Road,
Ballarat VIC 3350
Tel: (03) 5338 7837
Fax: (03) 5331 3335

TASMANIA

GP Glass
14 Kelcey Tier Road,
Spreyton TAS 7310
Tel: (03) 6427 3166
Fax: (03) 6427 3161

ADELAIDE

15-17 Indama Street,
Regency Park SA 5010
Tel: (08) 8347 0866
Fax: (08) 8347 0522

BRISBANE/ GOLD COAST

134 Lahrs Road,
Ormeau QLD 4208
Tel: (07) 5549 4100
Fax: (07) 5549 4111

SUNSHINE COAST

27-43 Skyreach Street,
Caboolture QLD 4510
Tel: (07) 5428 9200
Fax: (07) 5428 9222

Trend® National Customer Assistance Centre

13 72 74

(between 8:30am - 4:30pm EST, M-F) Product not available in WA

www.trendwindows.com.au

email: info@trendwindows.com.au



Trend® Windows & Doors Pty Limited, ABN 96 000 433 492
TM denotes a trademark and ® denotes a registered trademark
owned by Trend® Windows & Doors Pty Limited. © owned by
Trend® Windows & Doors Pty Limited - TREND150_MAY09