

A light blue square logo containing the text "STORMTECH Pty Ltd".

STORMTECH Pty Ltd

Product Guide

Architectural grates + drains

The Slimline series is a patented, Australian designed lineal grated drain system that can be used anywhere a high performance, high quality contemporary style drainage solution is needed.

Stormtech grates are made of stainless steel and are manufactured in Australia to ensure consistent high quality and timely supply.

Stormtech Product Guide

CONTENTS

ARG Series Grate and Fittings	Page 1-4	PHI Series Grate and Fittings	Page 12-13
ARI Series Grate and Fittings	Page 5-6	PSG Series Grate and Fittings	Page 14-16
ARIC Series Grate and Fittings	Page 7	PSI Series Grate and Fittings	Page 17-18
TIFG Series Grate and Fittings	Page 7	Custom Projects	Page 19
TIFI Series Grate and Fittings	Page 8	Slot Drain	Page 20
PHG Series Grate and Fittings	Page 9-11	Special Assemblies	Page 20-21

All information effective 1st October 2010



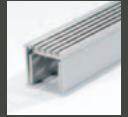

ARG Series

Modular site finish system, wedge wire grate, manufactured from stainless steel combined with a UPVC channel available in 38mm, 65mm and 100mm grate widths and depths of 25mm and 40mm.

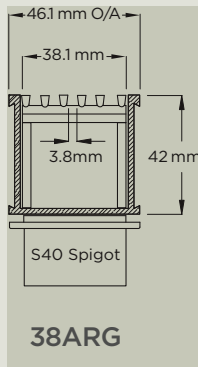

Kits | 38ARG

Modular kit with architectural stainless steel grate, UPVC channel and fittings.

Width : 38mm | Depth : 40mm
Stainless Steel Grade 316

PRODUCT	LENGTH - UP TO -
38ARG1200	1200mm
38ARG2400	2400mm
38ARG3600	3600mm
38ARG4800	4800mm
38ARG6000	6000mm
38ARG7200	7200mm
38ARG8400	8400mm

Grates Only | 38AR

Architectural stainless steel grate.

Width : 38mm | Depth : 40mm
Stainless Steel Grade 316

PRODUCT	LENGTH
38AR1200	1200mm

Channel and Fitting Components | 38AR

PRODUCT	ITEM DESCRIPTION
38G3000	Grey UPVC channel Depth: 40mm Length: 3000mm
38G1500	Grey UPVC channel Depth: 40mm Length: 1500mm
E38	Pair of PVC stop ends for 38G channel
F40	40mm floor flange
GA40	Pair of PVC angle joiners for 65G and 38G channels
GJ40	Pair of PVC joiners for 65G and 38G channels
S40	Spigot for 38G channel (fit into 40mmDWV pipe)

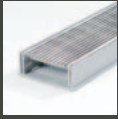

65ARG25 | 65mm x 25mm

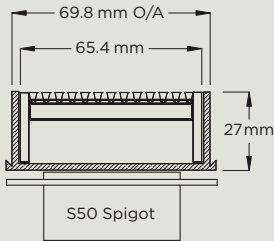

65ARG25

Kits | 65ARG25

Modular kit with architectural stainless steel grate, UPVC channel and fittings.

Width : 65mm | Depth : 25mm
Stainless Steel Grade 304

Grates Only | 65AR25

Architectural stainless steel grate.

Width : 65mm | Depth : 25mm
Stainless Steel Grade 304

PRODUCT	LENGTH
65AR25-0750	750mm
65AR25-0900	900mm
65AR25-1000	1000mm
65AR25-1200	1200mm

PRODUCT	LENGTH - UP TO -
65ARG25-0750	750mm
65ARG25-0900	900mm
65ARG25-1000	1000mm
65ARG25-1200	1200mm
65ARG25-1500	1500mm
65ARG25-1650	1650mm
65ARG25-1800	1800mm
65ARG25-1900	1900mm
65ARG25-2000	2000mm
65ARG25-2100	2100mm
65ARG25-2200	2200mm
65ARG25-2400	2400mm
65ARG25-2500	2500mm
65ARG25-2700	2700mm
65ARG25-2800	2800mm
65ARG25-3000	3000mm
65ARG25-3600	3600mm
65ARG25-4200	4200mm
65ARG25-4500	4500mm
65ARG25-4800	4800mm
65ARG25-5400	5400mm
65ARG25-5700	5700mm
65ARG25-6000	6000mm

Channel and Fitting Components | 65AR25

PRODUCT	ITEM DESCRIPTION
65G25-3000	Grey UPVC channel Depth: 25mm Length: 3000mm
65G25-1500	Grey UPVC channel Depth: 25mm Length: 1500mm
E65G25	Pair of PVC stop ends for 65G25 channel
GA25	Pair of PVC angle joiners for 65G25 channel
GJ25	Pair of PVC joiner strips for 65G25 channel
S50	Spigot for 65G channel (fit into 50mm DWV)
F50	50mm floor flange

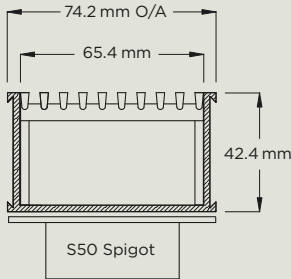
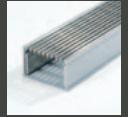

65ARG40

Kits | 65ARG40

Modular kit with architectural stainless steel grate, UPVC channel and fittings.

Width : 65mm | Depth : 40mm
Stainless Steel Grade 316

Grates Only | 65AR40

Architectural stainless steel grate.

Width : 65mm | Depth : 40mm
Stainless Steel Grade 316

PRODUCT	LENGTH
65AR40-0900	900mm
65AR40-1200	1200mm

PRODUCT	LENGTH - UP TO -
65ARG40-0900	900mm
65ARG40-1200	1200mm
65ARG40-1800	1800mm
65ARG40-2100	2100mm
65ARG40-2400	2400mm
65ARG40-2700	2700mm
65ARG40-3000	3000mm
65ARG40-3600	3600mm
65ARG40-4200	4200mm
65ARG40-4500	4500mm
65ARG40-4800	4800mm
65ARG40-5400	5400mm
65ARG40-5700	5700mm
65ARG40-6000	6000mm

Channel and Fitting Components | 65AR40

PRODUCT	ITEM DESCRIPTION
65G40-3000	Grey UPVC channel Depth: 40mm Length: 3000mm
65G40-1500	Grey UPVC channel Depth: 40mm Length: 1500mm
E65G40	Pair of PVC stop ends for 65G40 channel
F50	50mm floor flange
S50	Spigot for 65G channel (fit into 50mm DWV)
GA40	Pair of PVC angle joiners for 65G and 38G channels
GJ40	Pair of PVC joiner strips for 65G and 38G channels

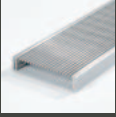

100ARG20 | 100mm x 20mm

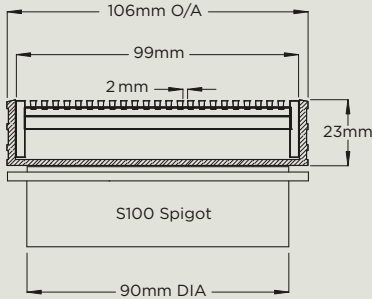

100ARG

Kits | 100ARG20

Modular kit with architectural stainless steel grate, UPVC channel and fittings.

Width : 100mm | Depth : 20mm
Stainless Steel Grade 316

PRODUCT	LENGTH - UP TO -
100ARG20-0900	900mm
100ARG20-1000	1000mm
100ARG20-1200	1200mm
100ARG20-1800	1800mm
100ARG20-1900	1900mm
100ARG20-2000	2000mm
100ARG20-2100	2100mm
100ARG20-2200	2200mm
100ARG20-2400	2400mm
100ARG20-2700	2700mm
100ARG20-2800	2800mm
100ARG20-2900	2900mm
100ARG20-3000	3000mm
100ARG20-3200	3200mm
100ARG20-3400	3400mm
100ARG20-3600	3600mm
100ARG20-3700	3700mm
100ARG20-3800	3800mm
100ARG20-3900	3900mm
100ARG20-4000	4000mm
100ARG20-4200	4200mm
100ARG20-4400	4400mm
100ARG20-4500	4500mm
100ARG20-4600	4600mm
100ARG20-4700	4700mm
100ARG20-4800	4800mm
100ARG20-4900	4900mm
100ARG20-5000	5000mm
100ARG20-5100	5100mm
100ARG20-5200	5200mm
100ARG20-5400	5400mm
100ARG20-5500	5500mm
100ARG20-5700	5700mm
100ARG20-5800	5800mm
100ARG20-6000	6000mm

Grates Only | 100AR20

Architectural stainless steel grate.

Width : 100mm | Depth : 20mm

Stainless Steel Grade 316

PRODUCT	LENGTH
100AR20-0900	900mm
100AR20-1000	1000mm
100AR20-1200	1200mm

Channel and Fitting Components | 100AR20

PRODUCT	ITEM DESCRIPTION
100G3000	Grey 100G UPVC channel Depth: 20mm Length: 3000mm
100G1500	Grey 100G UPVC channel Depth: 20mm Length: 1500mm
E100	Pair of PVC Stop ends for 100G channel
S100	Spigot for 100G channel (fits 100mm DWV pipe)
S80	Spigot for 100G channel (fits 80mm DWV pipe)
100GA	Angle joiner for 100G channel
100GJ	Joiner strips for 100G channel

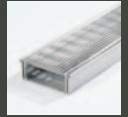

ARI Series

Modular all stainless steel system (with architectural grate, stainless steel channel and fittings) available in 65mm width grate.

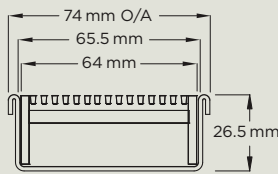

65ARI25

Kits | 65ARI25

Modular kit with architectural stainless steel grate, channel and fittings.

Width : 65mm | Depth : 25mm
Stainless Steel Grade 304

Grates Only | 65AR25

Architectural stainless steel grate.

Width : 65mm | Depth : 25mm
Stainless Steel Grade 304

PRODUCT	LENGTH
65AR25-0750	750mm
65AR25-0900	900mm
65AR25-1000	1000mm
65AR25-1200	1200mm

PRODUCT	LENGTH - UP TO -
65ARI25-0750	750mm
65ARI25-0900	900mm
65ARI25-1000	1000mm
65ARI25-1200	1200mm
65ARI25-1500	1500mm
65ARI25-1650	1650mm
65ARI25-1800	1800mm
65ARI25-1900	1900mm
65ARI25-2000	2000mm
65ARI25-2100	2100mm
65ARI25-2200	2200mm
65ARI25-2400	2400mm
65ARI25-2500	2500mm
65ARI25-2700	2700mm
65ARI25-2800	2800mm
65ARI25-3000	3000mm

Channel and Fitting Components | 65AR25

PRODUCT	ITEM DESCRIPTION
65I25-0900	Stainless steel channel (Grade 304) Depth: 25mm Length: 900mm
65I25-1200	Stainless steel channel (Grade 304) Depth: 25mm Length: 1200mm
65IS25-50	Spigot section for 65I 25 stainless steel channel with 51mm outlet
E65I25	Pair of stainless steel stop ends for 65I25 channel
GAI25	Stainless steel angle joiner for 65I25 channels
GJI25	Stainless steel joiner strips for 65I25 channels

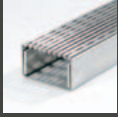

65ARI40 | 65mm x 40mm

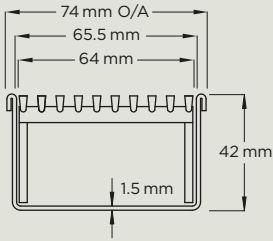

65ARI40

Kits | 65ARI40

Modular kit with architectural stainless steel grate, channel and fittings.

Width : 65mm | Depth : 40mm

Stainless Steel Grade:

Grate : Grade 316

Channel + Fittings : Grade 304

Grates Only | 65AR40

Architectural stainless steel grate.

Width : 65mm | Depth : 40mm

Stainless Steel Grade 316

PRODUCT	LENGTH
65AR40-0900	900mm
65AR40-1200	1200mm

PRODUCT	LENGTH - UP TO -
65ARI40-0900	900mm
65ARI40-1200	1200mm
65ARI40-1800	1800mm
65ARI40-2100	2100mm
65ARI40-2400	2400mm
65ARI40-2700	2700mm
65ARI40-3000	3000mm
65ARI40-3600	3600mm
65ARI40-4200	4200mm
65ARI40-4500	4500mm
65ARI40-4800	4800mm
65ARI40-5400	5400mm
65ARI40-5700	5700mm
65ARI40-6000	6000mm

Channel and Fitting Components | 65AR40

PRODUCT	ITEM DESCRIPTION
65I40-0900	Stainless steel channel (Grade 304) Depth: 40mm Length: 900mm
65I40-1200	Stainless steel channel (Grade 304) Depth: 40mm Length: 1200mm
E65I40	Pair of stainless steel stop ends for 65I40 channel
GAI40	Stainless steel angle joiner for 65I40 channels
GJI40	Stainless steel joiner strips for 65I40 channels
65IS40-50	Spigot section for 65I40 stainless steel channel with 51mm outlet

65ARIC | 65mm x 25mm



65TIFG | 65mm x 40mm

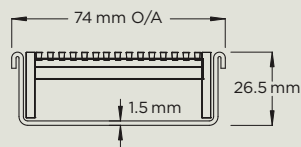
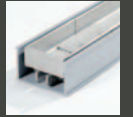

65ARIC25

ARIC Series

Completed all stainless steel non adjustable unit with architectural grate, stainless steel channel and fittings. Available in 65mm width.

Kits | 65ARIC25

Finished unit with architectural stainless steel grate and channel and centre outlet.

Width : 65mm | Depth : 25mm
Stainless Steel Grade 316

PRODUCT	LENGTH
65ARIC25-0900	900mm
65ARIC25-1000	1000mm

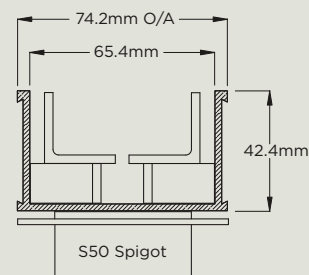

65TIFG40

TIFG Series

Modular system with stainless steel tile insert frame, UPVC channel and fittings. Available in 65mm width.

Kits | TIFG40

65mm wide modular kit with stainless steel tile insert frame, UPVC channel and fittings.

Width : 65mm | Depth : 40mm
Stainless Steel Grade:
 Tile Insert Frame : Grade 316

PRODUCT	LENGTH - UP TO -
65TIFG40-10	1000mm
65TIFG40-20	2000mm
65TIFG40-30	3000mm
65TIFG40-40	4000mm
65TIFG40-50	5000mm

Components | 65TIF40

PRODUCT	ITEM DESCRIPTION
65TIF40-1000	Stainless steel tile insert frame with adjustable ends Depth: 40mm Length: 1000mm
65G40-3000	Grey UPVC channel Depth: 40mm Length: 3000mm
65G40-1500	Grey UPVC channel Depth: 40mm Length: 1500mm
E65G40	Pair of PVC stop ends for 65G40 channel
F50	50mm floor flange
S50	Spigot for 65G channel (fit into 50mm DWV)
GA40	Pair of PVC angle joiners for 65G and 38G channels
GJ40	Pair of PVC joiner strips for 65G and 38G channels



65TIFI | 65mm x 40mm



TIFI Series

Modular all stainless steel system with tile insert frame, stainless steel channel and fittings.
Available in 65mm width.

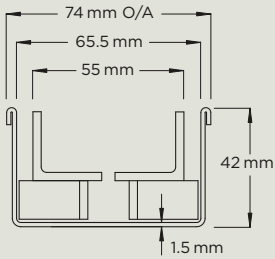

65TIFI40

Kits | 65TIFI

Modular kit with architectural stainless steel insert frame channel and fittings.

Width : 65mm | Depth : 40mm

Stainless Steel Grade:

Tile Insert Frame : Grade 316

Channel + Fittings : Grade 304

PRODUCT	LENGTH - UP TO -
65TIFI40-10	1000mm
65TIFI40-20	2000mm
65TIFI40-30	3000mm
65TIFI40-40	4000mm
65TIFI40-50	5000mm

Frame Only | 65TIF40

Stainless steel Tile Insert Frame with adjustable ends,

Width : 65mm | Depth : 40mm

Stainless Steel Grade 316

PRODUCT	LENGTH
65TIF40-1000	1000mm

Channel and Fitting Components | 65TIF40

PRODUCT	ITEM DESCRIPTION
65I40-0900	Stainless steel channel (Grade 304) Depth: 40mm Length: 900mm
65I40-1200	Stainless steel channel (Grade304) Depth: 40mm Length: 1200mm
E65I40	Pair of stainless steel stop ends for 65I40 channel
GAI40	Stainless steel angle joiner for 65I40 channels
GJI40	Stainless steel joiner strips for 65I40 channels
65IS40-50	Spigot section for 65I40 stainless steel channel with 51mm outlet

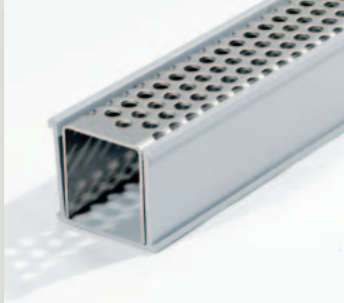
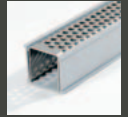

PHG Series

Modular system featuring punched hole stainless steel grate and UPVC channel and fittings.

Available in 38mm and 65mm grate widths, and depths of 25mm and 40mm.

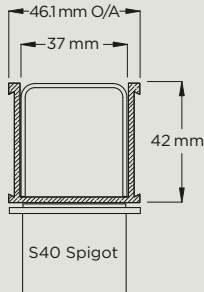

38PHG

Kits | 38PHG

Modular kit with punched hole stainless steel grate, UPVC channel and fittings.

Width : 38mm | Depth : 40mm
Stainless Steel Grade 316

PRODUCT	LENGTH - UP TO -
38PHG1200	1200mm
38PHG2400	2400mm
38PHG3600	3600mm
38PHG4800	4800mm
38PHG6000	6000mm

Grates Only | 38PH

Punched hole stainless steel grate.

Width : 38mm | Depth : 40mm
Stainless Steel Grade 316

PRODUCT	LENGTH
38PH1200	1200mm

Channel and Fitting Components | 38PH

PRODUCT	ITEM DESCRIPTION
38G3000	Grey UPVC channel Depth: 40mm Length: 3000mm
38G1500	Grey UPVC channel Depth: 40mm Length: 1500mm
E38	Pair of PVC stop ends for 38G channel
F40	40mm floor flange
GA40	Pair of PVC angle joiners for 65G and 38G channels
S40	Spigot for 38G channel (fit into 40DWV pipe)

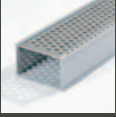

65PHG25 | 65mm x 25mm

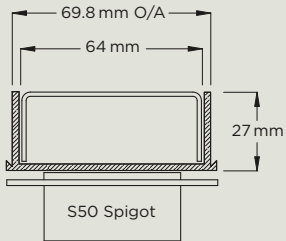

65PHG25

Kits | 65PHG25

Modular kit with punched hole stainless steel grate, UPVC channel and fittings.

Width : 65mm | Depth : 25mm
Stainless Steel Grade 316

PRODUCT	LENGTH - UP TO -
65PHG25-1200	1200mm
65PHG25-2400	2400mm
65PHG25-3600	3600mm
65PHG25-4800	4800mm
65PHG25-6000	6000mm

Grates Only | 65PH25

Punched hole stainless steel grate.

Width : 65mm | Depth : 25mm
Stainless Steel Grade 316

PRODUCT	LENGTH
65PH25-1200	1200mm

Channel and Fitting Components | 65PH25

PRODUCT	ITEM DESCRIPTION
65G25-3000	Grey UPVC channel Depth: 25mm Length: 3000mm
65G25-1500	Grey UPVC channel Depth: 25mm Length: 1500mm
E65G25	Pair of PVC stop ends for 65G25 channel
GA25	Pair of PVC angle joiners for 65G25 channel
GJ25	Pair of PVC joiner strips for 65G25 channel
S50	Spigot for 65G channel (fit into 50mm DWV)

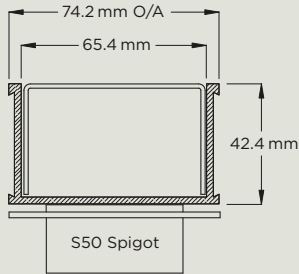
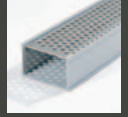

65PHG40

Kits | 65PHG40

Modular kit with punched hole stainless steel grate, UPVC channel and fittings.

Width : 65mm | Depth : 40mm
Stainless Steel Grade 316

PRODUCT	LENGTH - UP TO -
65PHG40-1200	1200mm
65PHG40-2400	2400mm
65PHG40-3600	3600mm
65PHG40-4800	4800mm
65PHG40-6000	6000mm

Grates Only | 65PH40

Punched hole stainless steel grate.

Width : 65mm | Depth : 40mm
Stainless Steel Grade 316

PRODUCT	LENGTH
65PH40-1200	1200mm

Channel and Fitting Components | 65PH40

PRODUCT	ITEM DESCRIPTION
65G40-3000	Grey UPVC channel Depth: 40mm Length: 3000mm
65G40-1500	Grey UPVC channel Depth: 40mm Length: 1500mm
E65G40	Pair of PVC stop ends for 65G40 channel
F50	50mm floor flange
S50	Spigot for 65G channel (fit into 50mm DWV)
GA40	Pair of PVC angle joiners for 65G and 38G channels
GJ40	Pair of PVC joiner strips for 65G and 38G channels

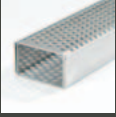

65PHI25 | 65mm x 25mm



PHI Series

Modular all stainless steel system with punched hole grate, channel and fittings.

Available in 65mm grate width, with depths of 25mm and 40mm.

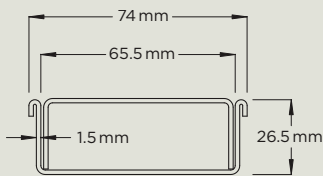

65PHI25

Kits | 65PHI25

Modular kit with punched hole stainless steel grate, channel and fittings.

Width : 65mm | Depth : 25mm

Stainless Steel Grade:

Grate : Grade 316

Channel + Fittings : Grade 304

PRODUCT	LENGTH - UP TO -
65PHI25-1200	1200mm
65PHI25-2400	2400mm
65PHI25-3600	3600mm
65PHI25-4800	4800mm
65PHI25-6000	6000mm

Grate Only | 65PH25

Punched hole stainless steel grate.

Width : 65mm | Depth : 25mm

Stainless Steel Grade 316

PRODUCT	LENGTH
65PH25-1200	1200mm

Channel and Fitting Components | 65PH25

PRODUCT	ITEM DESCRIPTION
65I25-0900	Stainless steel channel (Grade 304) Depth: 25mm Length: 900mm
65I25-1200	Stainless steel channel (Grade 304) Depth: 25mm Length: 1200mm
65IS25-50	Spigot section for 65I 25 stainless steel channel with 51mm outlet
E65I25	Pair of stainless steel stop ends for 65I25 channel
GAI25	Stainless steel angle joiner for 65I25 channels
GJI25	Stainless steel joiner strips for 65I25 channels

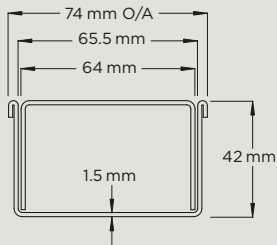
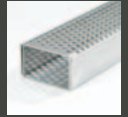

65PHI40

Kits | 65PHI40

Modular kit with punched hole stainless steel grate, channel and fittings.

Width : 65mm | Depth : 40mm

Stainless Steel Grade:

Grate : Grade 316

Channel + Fittings : Grade 304

PRODUCT	LENGTH - UP TO -
65PHI40-1200	1200mm
65PHI40-2400	2400mm
65PHI40-3600	3600mm
65PHI40-4800	4800mm
65PHI40-6000	6000mm

Grate Only | 65PH40

Punched hole stainless steel grate.

Width : 65mm | Depth : 40mm

Stainless Steel Grade 316

PRODUCT	LENGTH
65PH40-1200	1200mm

Channel and Fitting Components | 65PH40

PRODUCT	ITEM DESCRIPTION
65I40-0900	Stainless steel channel (Grade 304) Depth: 40mm Length : 900mm
65I40-1200	Stainless steel channel (Grade 304) Depth: 40mm Length: 1200mm
65IS40-50	Spigot section for 65I40 stainless steel channel with 51mm outlet
E65I40	Pair of stainless steel stop ends for 65I40 channel
GAI40	Stainless steel angle joiner for 65I40 channels
GJI40	Stainless steel joiner strips for 65I40 channels

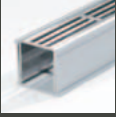

38PSG | 38mm x 40mm



PSG Series

Modular system with punched slot stainless steel grate combined with a UPVC channel and fittings.

38mm width grate available in 40mm depth and 65mm width grate available in 25mm and 40mm depth.

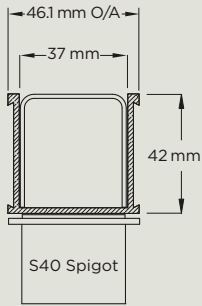

38PSG

Kits | 38PSG

Modular kit with punched slot stainless steel grate, UPVC channel and fittings.

Width : 38mm | Depth : 40mm
Stainless Steel Grade 316

PRODUCT	LENGTH - UP TO -
38PSG1200	1200mm
38PSG2400	2400mm
38PSG3600	3600mm
38PSG4800	4800mm
38PSG6000	6000mm

Grate Only | 38PS

Punched slot stainless steel grate.

Width : 38mm | Depth : 40mm
Stainless Steel Grade 316

PRODUCT	LENGTH
38PS1200	1200mm

Channel and Fitting Components | 38PS

PRODUCT	ITEM DESCRIPTION
38G3000	Grey UPVC Channel Depth: 40mm Length: 3000mm
38G1500	Grey UPVC Channel Depth: 40mm Length: 1500mm
E38	Pair of PVC Stop ends for 38G channel
F40	40mm Floor Flange
GA40	Pair of PVC angle joiners for 65G and 38G channels
GJ40	Pair of PVC joiner strips for 65G and 38G channels
S40	Spigot for 38G Channel (fit into 40DWV pipe)

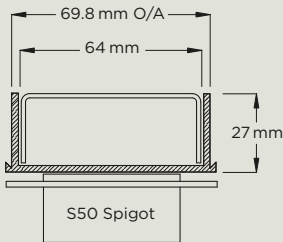

65PSG25

Kits | 65PSG25

Modular kit with punched slot stainless steel grate, UPVC channel and fittings.

Width : 65mm | Depth : 25mm
Stainless Steel Grade 316

PRODUCT	LENGTH - UP TO -
65PSG25-1200	1200mm
65PSG25-2400	2400mm
65PSG25-3600	3600mm
65PSG25-4800	4800mm
65PSG25-6000	6000mm

Grate Only | 65PS25

Punched slot stainless steel grate.

Width : 65mm | Depth : 25mm
Stainless Steel Grade 316

PRODUCT	LENGTH
65PS25-1200	1200mm

Channel and Fitting Components | 65PS25

PRODUCT	ITEM DESCRIPTION
65G25-3000	Grey UPVC channel Depth: 25mm Length: 3000mm
65G25-1500	Grey UPVC channel Depth: 25mm Length: 1500mm
E65G25	Pair of PVC stop ends for 65G25 channel
GA25	Pair of PVC angle joiners for 65G25 channel
GJ25	Pair of PVC joiner strips for 65G25 channel
S50	Spigot for 65G channel (fit into 50mm DWV)



65PSG40 | 65mm x 40mm

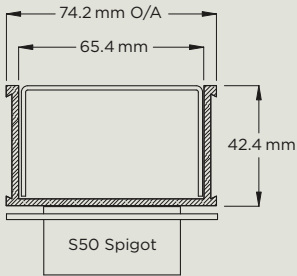

65PSG40

Kits | 65PSG40

Modular kit with punched slot stainless steel grate, UPVC channel and fittings.

Width : 65mm | Depth : 40mm
Stainless Steel Grade 316

PRODUCT	LENGTH - UP TO -
65PSG40-1200	1200mm
65PSG40-2400	2400mm
65PSG40-3600	3600mm
65PSG40-4800	4800mm
65PSG40-6000	6000mm

Grate Only | 65PS40

Punched slot stainless steel grate.

Width : 65mm | Depth : 40mm
Stainless Steel Grade 316

PRODUCT	LENGTH
65PS40-1200	1200mm

Channel and Fitting Components | 65PS40

PRODUCT	ITEM DESCRIPTION
65G40-3000	Grey UPVC Channel Depth: 40mm Length: 3000mm
65G40-1500	Grey UPVC Channel Depth: 40mm Length: 1500mm
E65G40	Pair of PVC stop ends for 65G40 channel
F50	50mm Floor Flange
S50	Spigot for 65G channel (fit into 50mm DWV)
GA40	Pair of PVC angle joiners for 65G and 38G channels
GJ40	Pair of PVC joiner strips for 65G and 38G channels

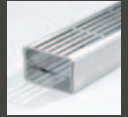

PSI Series

Modular all stainless steel system with punched slot grate, channel and fittings.

Available in 65mm grate width, with depths of 25mm and 40mm.

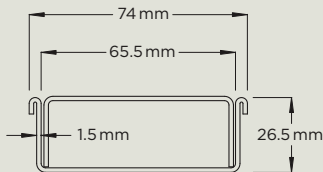

65PSI25

Kits | 65PSI25

Modular kit with punched slot stainless steel grate, channel and fittings.

Width : 65mm | Depth : 25mm

Stainless Steel Grade:

Grate : Grade 316

Channel + Fittings : Grade 304

PRODUCT	LENGTH - UP TO -
65PSI25-1200	1200mm
65PSI25-2400	2400mm
65PSI25-3600	3600mm
65PSI25-4800	4800mm
65PSI25-6000	6000mm

Grate Only | 65PS25

Punched slot stainless steel grate.

Width : 65mm | Depth : 25mm

Stainless Steel Grade 316

PRODUCT	LENGTH
65PS25-1200	1200mm

Channel and Fitting Components | 65PS25

PRODUCT	ITEM DESCRIPTION
65I25-0900	Stainless steel channel (Grade 304) Depth: 25mm Length: 900mm
65I25-1200	Stainless steel channel (Grade 304) Depth: 25mm Length: 1200mm
65IS25-50	Spigot section for 65I25 stainless steel channel with 51mm outlet
E65I25	Pair of stainless steel stop ends for 65I25 channel
GAI25	Stainless steel angle joiner for 65I25 channels
GJI25	Stainless steel joiner strips for 65I25 channels

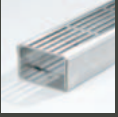

65PSI40 | 65mm x 40mm

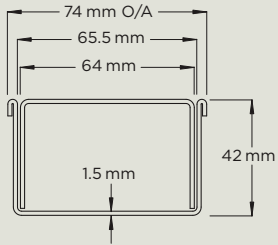

65PSI40

Kits | 65PSI40

Modular kit with punched slot stainless steel grate, channel and fittings.

Width : 65mm | Depth : 40mm

Stainless Steel Grade:

Grate : Grade 316

Channel + Fittings : Grade 304

PRODUCT	LENGTH - UP TO -
65PSI40-1200	1200mm
65PSI40-2400	2400mm
65PSI40-3600	3600mm
65PSI40-4800	4800mm
65PSI40-6000	6000mm

Grate Only | 65PS40

Punched slot stainless steel grate.

Width : 65mm | Depth : 40mm

Stainless Steel Grade 316

PRODUCT	LENGTH
65PS40-1200	1200mm

Channel and Fitting Components | 65PS40

PRODUCT	ITEM DESCRIPTION
65I40-0900	Stainless steel channel (Grade 304) Depth: 40mm Length: 900mm
65I40-1200	Stainless steel channel (Grade 304) Depth: 40mm Length: 1200mm
65IS40-50	Spigot section for 65I 40 stainless steel channel with 51mm outlet
E65I40	Pair of stainless steel stop ends for 65I40 channel
GAI40	Stainless steel angle joiner for 65I40 channels
GJI40	Stainless steel joiner strips for 65I40 channels

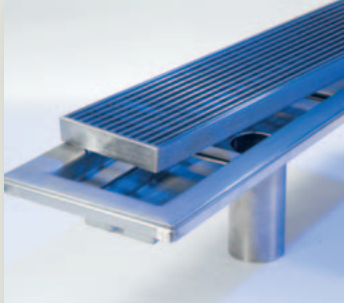
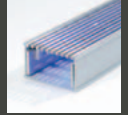

Custom Projects

For site specific needs, Stormtech can customise any drainage requirement to achieve maximum efficiency.

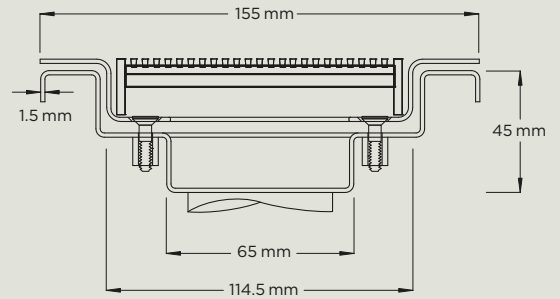

VC155-45

PRODUCT	ITEM DESCRIPTION
65ARI	65mm wide stainless steel grate and stainless steel channel (Grade 316) Depth: minimum 20mm, maximum 40mm. Finished to custom length.
100ARI	100mm wide stainless steel grate and stainless steel channel (Grade 316) Depth: minimum 20mm, maximum 40mm. Finished to custom length.
100TIFI40	100mm wide stainless steel Tile Insert Frame and stainless steel channel (Grade 316) Depth: 40mm. Finished to custom length.
VC155-45	Stainless steel vinyl clamp Depth: 45mm Width: 155mm Outlet: 50mm. Finished to custom length
LED1000	LED strip complete with adaptor to be fitted to any grate Length: 1000mm

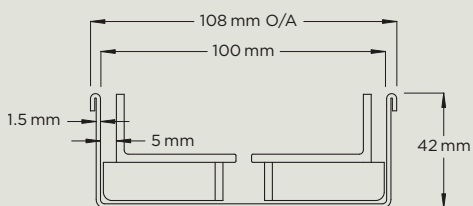
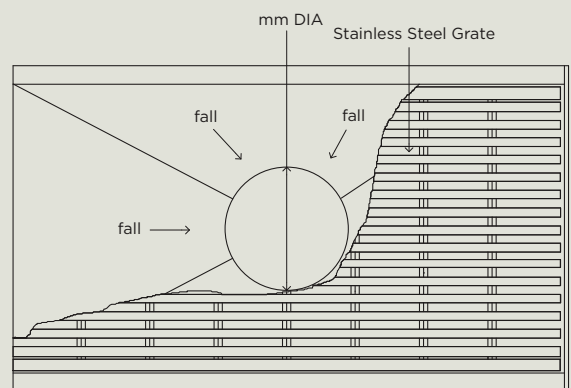
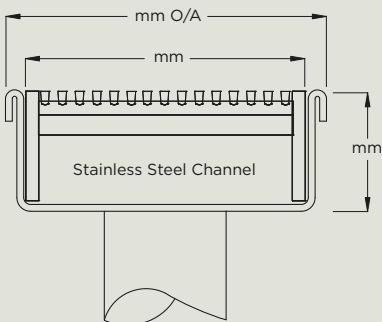

100TIFI40



Slot Drain | 25mm

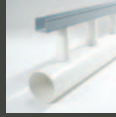

Special Assembly | 65mm



Slot Drain

The original Stormtech Slot Drain features a 25mm opening, draining into a concealed 90mm drainpipe.

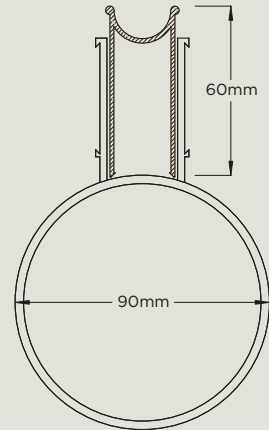

Slot Drain

Components | 25mm Slot Drain

PRODUCT	ITEM DESCRIPTION
SD90	90mm drain with UPVC beige insert (no holes) Length: 3000mm
SDi	Replacement Slot Drain insert (no holes) Length: 3000mm
SDh	10mm holes at 50mm centres
SDj	SD Joiner



Special Assembly Series

Utilising a UPVC channel connected to sockets at 200mm intervals.

Available in 38mm and 65mm width top channel, completed with a grate from the AR, PH or PS series.

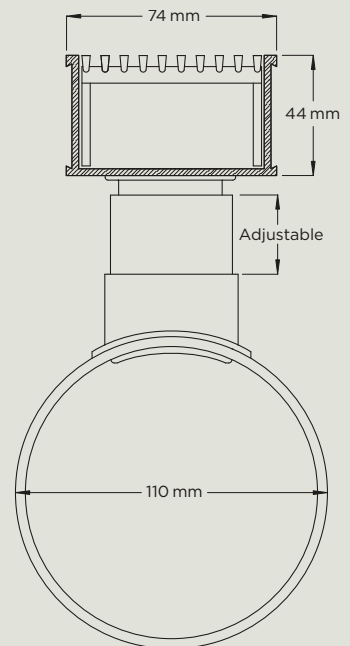

65G100

Components | 65mm Special Assembly

PRODUCT	ITEM DESCRIPTION
65G100	65G channel and 100mm drain pipe assembly. Length: 3000mm
65G90	65G channel and 90mm drain pipe assembly. Length: 3000mm
E65G40	Pair of PVC stop ends for 65G40 channel
GA40	Pair of PVC angle joiners for 65G and 38G channels
GJ40	Pair of PVC joiner strips for 65G and 38G channels

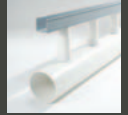

Components | 65mm Special Assembly (continued)

PRODUCT	ITEM DESCRIPTION
65AR40-0900	65mm wide architectural stainless steel grate (Grade 316) Depth: 40mm Length: 900mm
65AR40-1200	65mm wide architectural stainless steel grate (Grade 316) Depth: 40mm Length: 1200mm
65PH40-1200	Punched hole stainless steel grate (Grade 316) Depth: 40mm Length: 1200mm
65PS40-1200	65mm wide punched slot stainless steel grate (Grade 316) Depth: 40mm Length: 1200mm

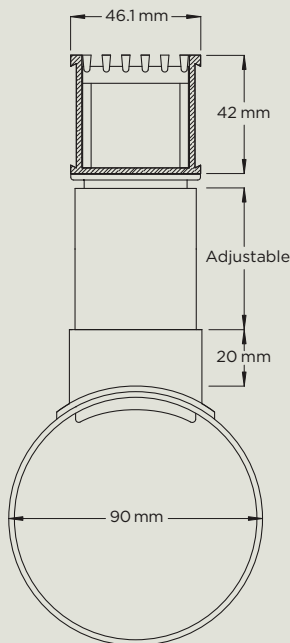

38G90

Components | 38mm Special Assembly

PRODUCT	ITEM DESCRIPTION
38G100	38G channel & 100mm drain pipe assembly. 3000mm
38G90	38G channel & 90mm drain pipe assembly. 3000mm
E38	Pair of PVC stop ends for 38G channel
GA40	Pair of PVC angle joiners for 65G and 38G channels
GJ40	Pair of PVC joiner strips for 65G and 38G channels
38AR1200	38mm wide architectural stainless steel grate (Grade 316) Depth: 40mm Length: 1200mm
38PH1200	38mm wide punched hole grate (Grade 316) Depth: 40mm Length: 1200mm
38PS1200	38mm wide punched slot grate (Grade 316) Depth: 40mm Length: 1200mm

Sockets

PRODUCT	ITEM DESCRIPTION
SOC09	40mm to 90mm socket
SOC10	40mm to 100mm socket
SOC15	40mm to 150mm socket



www.stormtech.com.au

PRODUCT DETAILS

For full product details, including assembly and installation information, visit our website.

TECHNICAL DRAWINGS

To assist planning your project We provide complete CAD files for download from our website.

DISTRIBUTORS

To find a distributor near you, please visit our website or call our office.

StormtechTM

Stormtech Pty Ltd | Unit 11, 10 Central Avenue, South Nowra, NSW, 2541 Australia

Telephone +61 2 4423 1989 **Facsimile** +61 2 4423 5552 **Email** info@stormtech.com.au