

SUPA/TILE 10

Premium Fully Accessible Ceiling System

NEW!

- Slim Line Joints
- 100% Accessibility
- Creative Design



SUPATILE 10

Premium Fully Accessible Ceiling System

Does your ceiling system provide all these benefits?

- ✓ - 100% accessibility to services in the ceiling cavity
- ✓ - Fits into standard ceiling suspension systems
- ✓ - Allows minimal ceiling cavity space
- ✓ - Service panels for lights, exit signs and other fixtures
- ✓ - Quick to install = lower costs
- ✓ - Visual appeal with design flexibility
- ✓ - A range of contemporary timber finishes
- ✓ - Demarcation of specific areas
- ✓ - Acoustic panels for noise reduction
- ✓ - Perimeter upstand for floating ceilings
- ✓ - Provides Green Star credit points
- ✓ - Fire Retardant choices available
- ✓ - Easy to wipe clean
- ✓ - Outstanding in durability

Supatile 10 ticks all the boxes!

Patent 2010100117

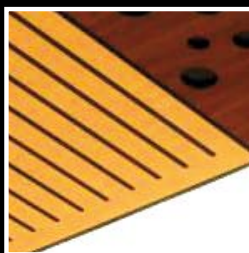
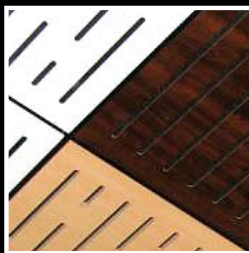
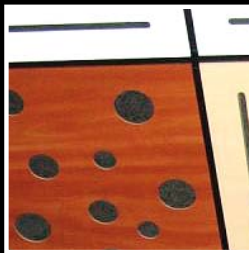
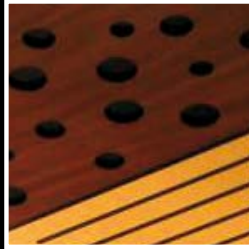

SUPAFINISH Concept Veneers & Colours



Hoop Pine



Fusion Maple



Beech



Tasmanian Oak

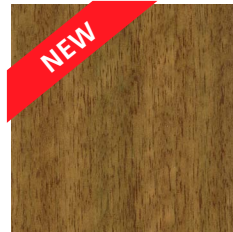

Spotted Gum

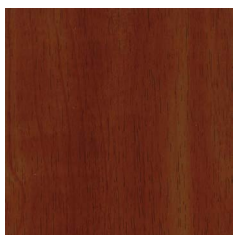

Smooth Mahogany

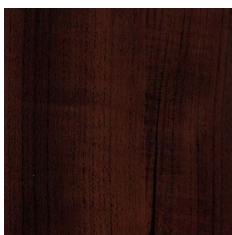

Cracked Cherry

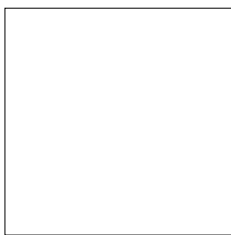

White

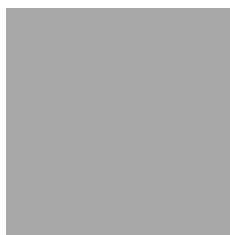

Matt Silver



Black

SUPATILE 10 Decorative & Acoustic Options

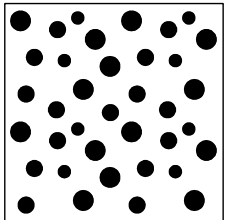

Bubbles

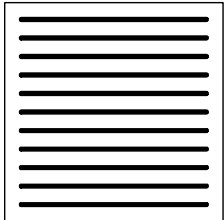

Stripe

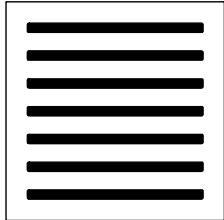

Zebra

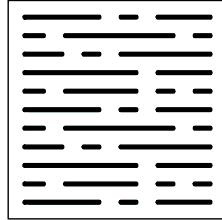

Cyberspace

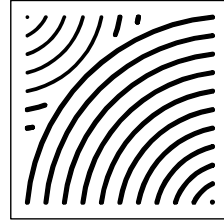

Ripple

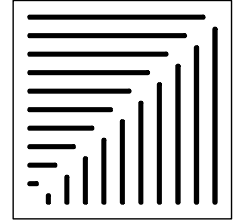

Angle

* Also available as a solid panel 'Smooth'

SUPATILE 10 Acoustic Service Panels Suits services up to 150mm diameter

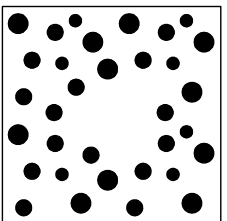

Bubbles SP

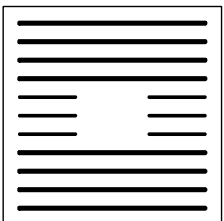

Stripe SP

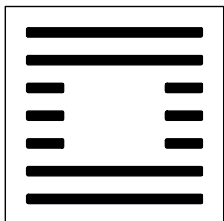

Zebra SP

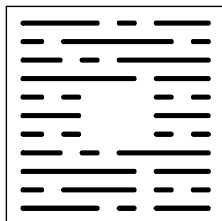

Cyberspace SP

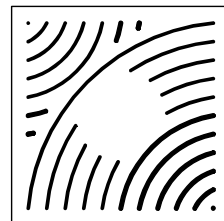

Ripple SP



Angle SP

SUPATILE 10 How it works...

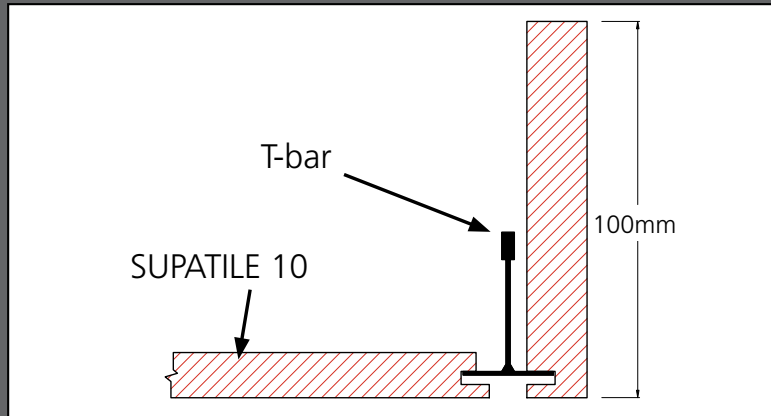
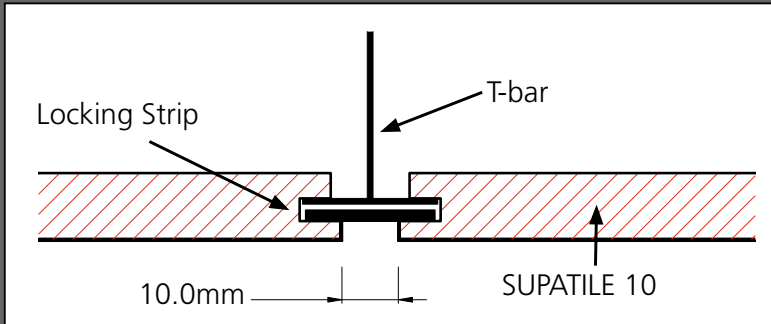

Suggested Specification Wording

SUPATILE FEATURE CEILING

- ➔ Ceiling to be SUPATILE 10 shadowline grid system.
- ➔ Grid to be 600x600 modules in black colour to be supplied and installed in accordance with SUPAWOOD's SUPATILE 10 Framing Requirements.
- ➔ Panel Finish to be ... with matching edges.
- ➔ Acoustic tile pattern to be ... in locations shown on RCP.
- ➔ Panel installation to be in accordance with SUPAWOOD's SUPATILE 10 Panel installation and removal procedure and AS/NZS 2785.

For more product information:

SUPAWOOD produce an extensive range of market-leading panel systems and are looking forward to working with you to deliver on your requirements.

Website: www.supawood.com.au

Phone: Toll Free 1800 002 123

Fax: 02 6331 8885

Email: supatile@supawood.com.au

Patent 2010100117

