

# ARCHITECTURAL GRATES + DRAINS



Stormtech

™



**Grate** Innovation + Design.



## STANDARD INSTALLATION

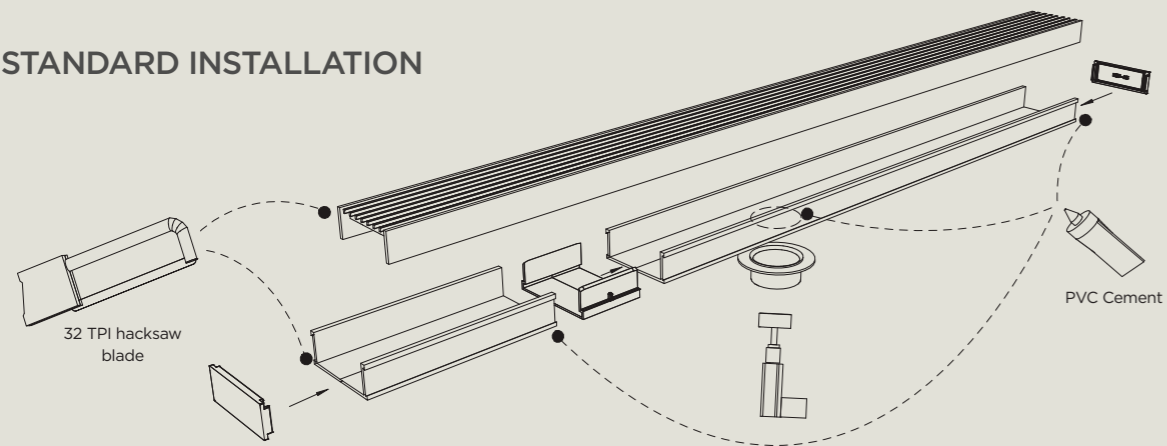

These drawings illustrate our standard installation.

Product specific diagrams and CAD drawings are available from our website.

Contact us to assist with product selection for AS3500 installation requirements.

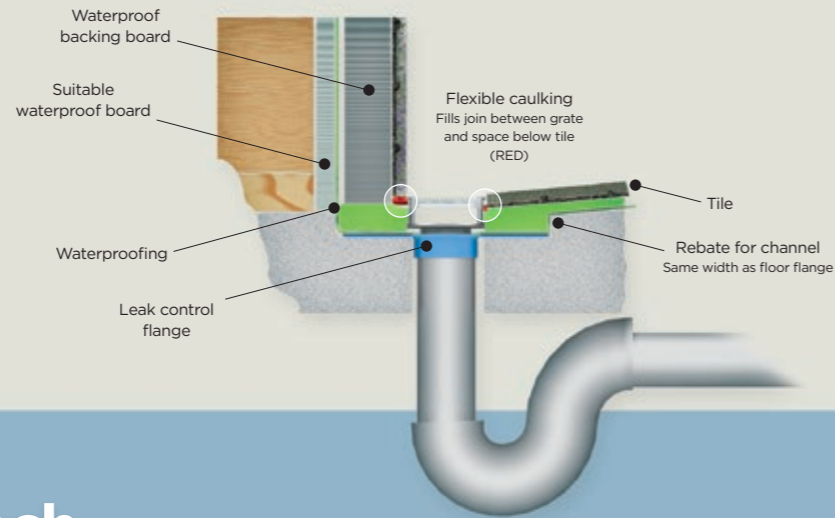

## Slimline by Stormtech.



Grate versatility.

## WELCOME

The Slimline series is a patented, Australian designed and made lineal grated drain system that can be used anywhere a high performance, high quality contemporary style drainage solution is needed.

Stormtech grates are made of stainless steel and are manufactured in Australia to ensure consistent high quality and timely supply.



## ARCHITECTURAL AND RESIDENTIAL

**Balconies**

**Bathrooms**

**Courtyards**

**Doortracks**

**Driveways**

**Paved Areas**

**Patios**

**Pools**

**Suspended Slabs**

**Thresholds**

**Wet Areas**



A narrow profile and high efficiency lineal drainage system that creates an aesthetically pleasing solution to the traditional grated drain.

The quality finish, blends well with designed contours and suits a variety of surfaces including pavers, tiles, concrete and vinyl.





**Grate  
versatility.**



**Grate  
simplicity.**



## COMMERCIAL PROJECTS

- Airports**
- Carparks**
- Parks and Playgrounds**
- Public Areas**
- Sporting Grounds**
- Gymnasiums**
- Thresholds**

The range of Stormtech Slimline products are suitable for many commercial purposes and large-scale outdoor applications.

Aesthetically pleasing, they provide extreme efficiency and ease of access in high traffic areas.



## HOSPITALS AND AGED CARE

- Bathrooms**
- Doortracks**
- Dining areas**
- Outdoor areas**
- Showers**
- Thresholds**

Originally designed for those with special needs, Stormtech Slimline grates allow hobless entry to the shower and more room to manoeuvre in the bathroom. The shower floor falls in one direction, giving greater stability to a wheelchair or stool, and avoids rocking.

Stormtech Slimline grates allow disabled people a greater self-sufficiency in the bathroom.

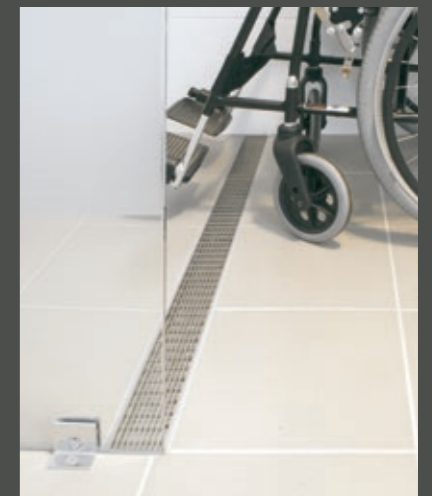



Grate  
innovation.

## HOSPITALITY

Bars and Restaurants

Bathrooms and Showers

Hotels and Resorts

Kitchens

Pools

Thresholds

Unique in their efficiency and versatility, Stormtech grates are ideal for new construction as well as retrofitting during renovation.

Providing a beautiful finish and ease of access for architectural requirements.



## PRODUCT RANGE

### AR Series



Available in kits or individual components.

Modular site finish system, featuring the original, architectural wedge wire grate, manufactured from 316 grade stainless steel combined with a UPVC or stainless steel channel.

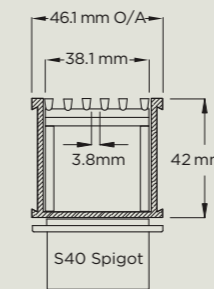

38ARG

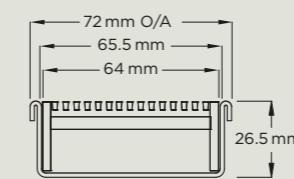

65ARI25

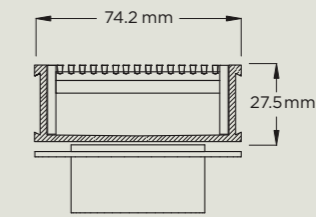

65ARG25

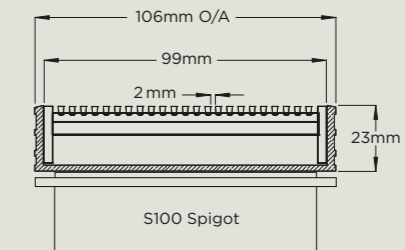

100ARG20

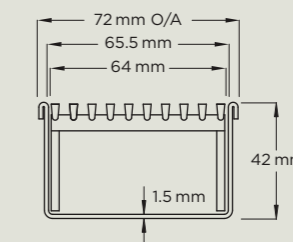

65ARI40

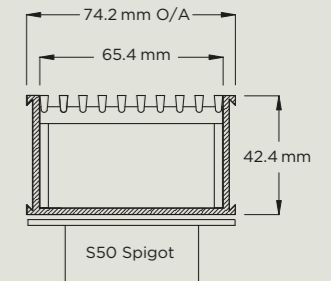

65ARG40

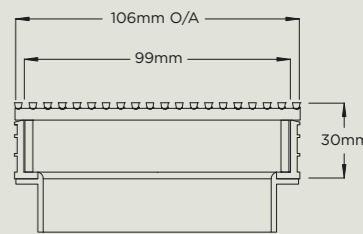

100ARG30

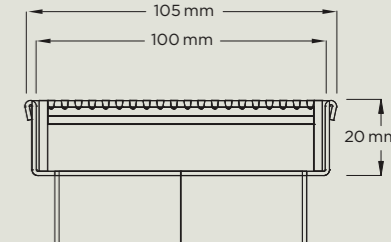

100ARI20

### MND Series



This decorative grate series incorporates Marc Newson's signature tessellated hexagonal pattern and is available in five distinct finishes.

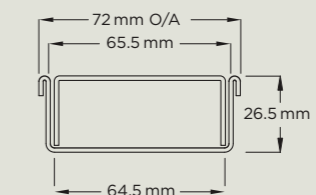

65MNDI25

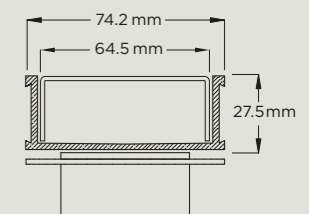

65MNDG25

## ARIC Series



The ARIC Series is a fully finished ready to install all stainless featuring a wedge wire architectural stainless steel grate and channel manufactured from 316 marine grade. Available in 25mm, 65mm and 100mm wide.

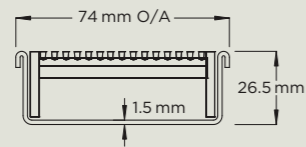

65ARIC25

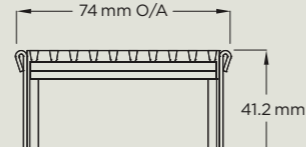

65ARIC40

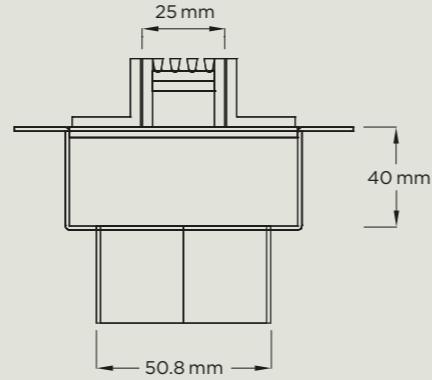

25SDIF

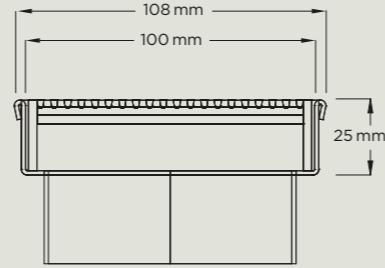

100ARIC25

## PS Series



Featuring a stainless steel slot perforated grate combined with a UPVC or stainless channel.

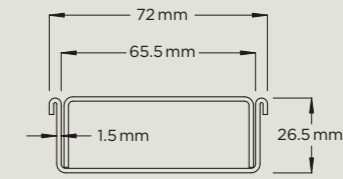

65PSI25

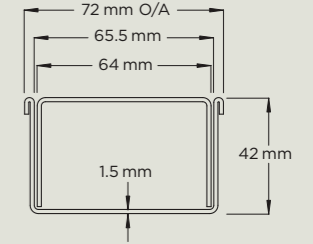

65PSI40

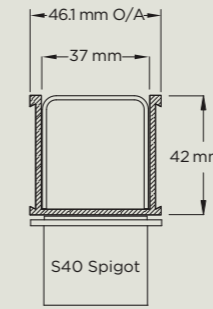

38PSG

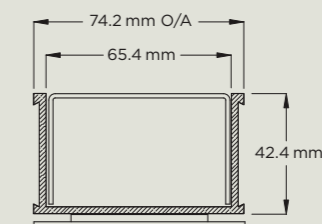

65PSG40

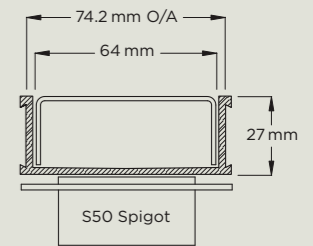

65PSG25

Available in kits or individual components.

## TIF Series



Featuring a 316 grade stainless steel tile insert frame, the TIF series is designed to blend the drainage system perfectly with your chosen solid surface finish.

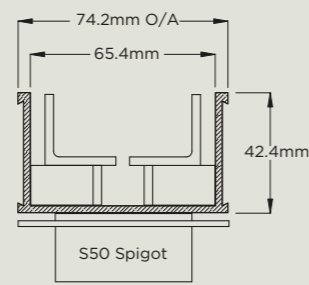

65TIFG40

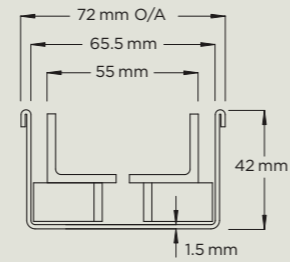

65TIFI40

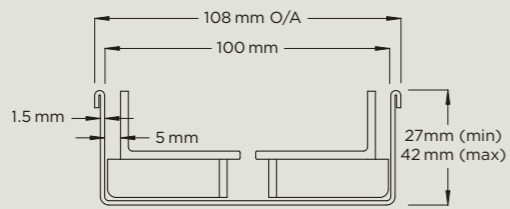

100TIFI

(Custom Fabrication)

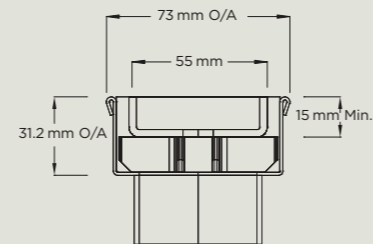

65TIFI30

## PH Series



Featuring 316 grade stainless steel circular hole punched grate, combined with a PVC or stainless steel channel.

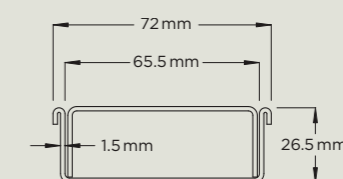

65PHI25

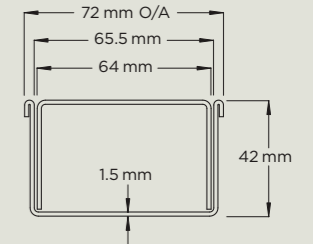

65PHI40

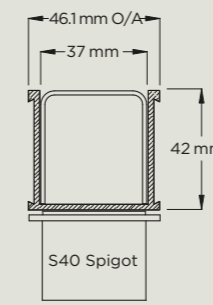

38PHG

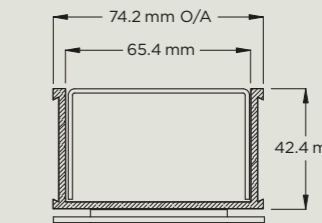

65PHG40

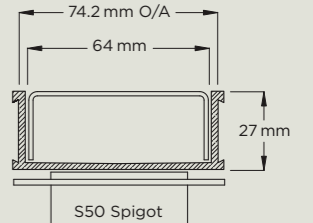

65PHG25

Available in kits or individual components.

Available in kits or individual components.



**SQ Series**

A more traditional square drain, manufactured from 316 grade stainless steel. Available with an architectural wedgewire grate, or a tile insert frame to incorporate any chosen tile or solid floor surface material.

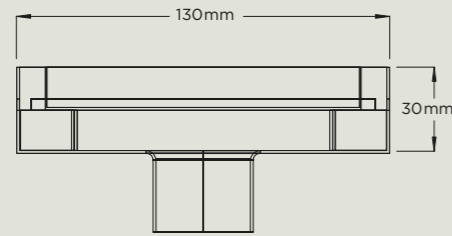

**SQ100TIF**

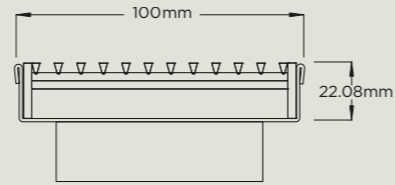

**SQ100AR**

**Slot Drain**

Ideal for stormwater run-off and surface water drainage around driveways, paved areas, sporting areas and garden edges.

The original Stormtech Slot Drain features a 25mm opening, draining into a concealed 90mm drainpipe.

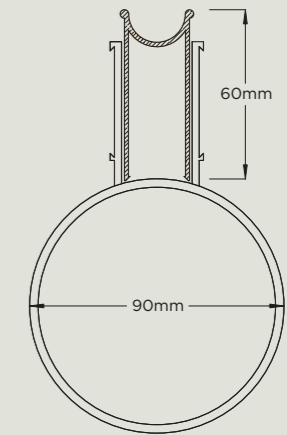

**Slot Drain**

**Threshold Series**

Featuring a linear stainless steel architectural, wedgewire grate, with an integrated concealed channel section which connects all sub sill sections for doortracks and thresholds. Allows doorsills to be drained while having internal and external floor surfaces with zero stepdown.

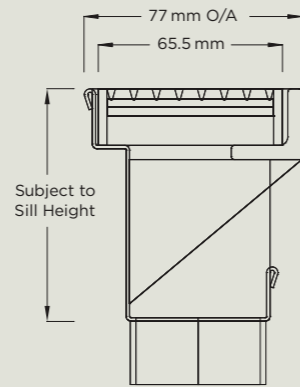

**65ARTDI**

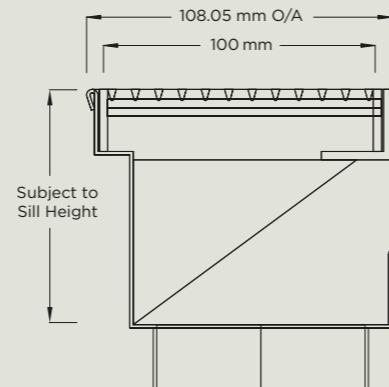

**100ARTDI**

**Vinyl Clamp**

Allows lineal grate use in a vinyl floor environment. Suitable for hospitals, commercial kitchens, schools, etc.

Stainless steel channel and screwdown flange mechanically clamp the vinyl beneath.

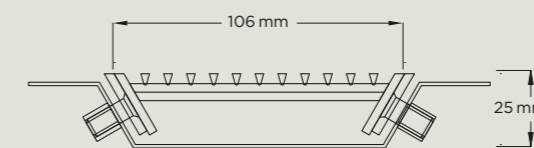
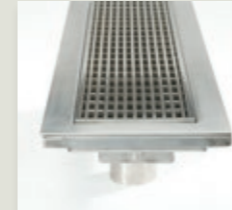

**VC155-25**

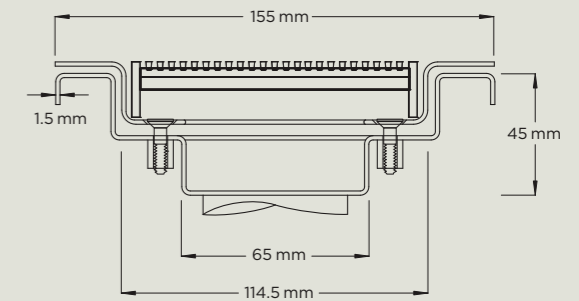

**VC155-45**

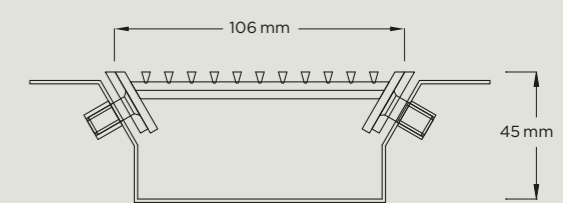

**VC155-42**

**Special Assembly**

The Special Assembly series has been developed for high capacity drainage needs, providing greater flexibility in landscape and pool design.

Utilising a UPVC channel connected via downpipes at 200mm intervals to sockets in the drain pipe below.

This drainage system is available in 38mm and 65mm width top channel. It is then completed with a stainless steel grate from the AR, PH or PS series, as a separate item.

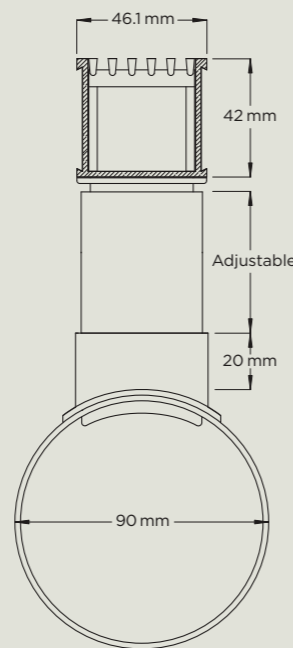

**38G90**

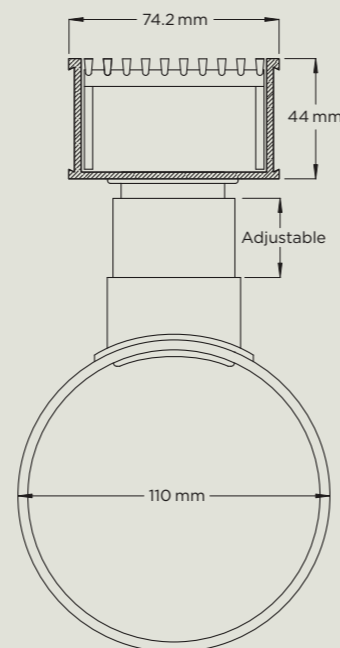

**65G100**

**Custom Design**

For site specific needs or unusual situations, Stormtech can customise any drainage requirements to achieve maximum efficiency.

To create a luxurious ambience, a waterproof LED strip can be fitted to any Stormtech grate.

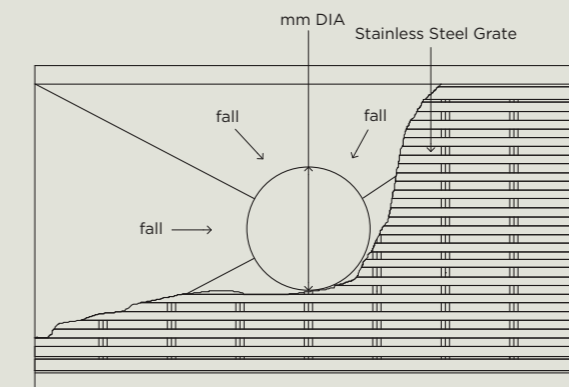
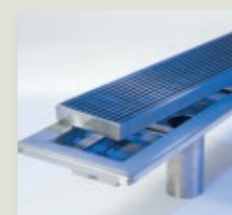

**OUTLET**

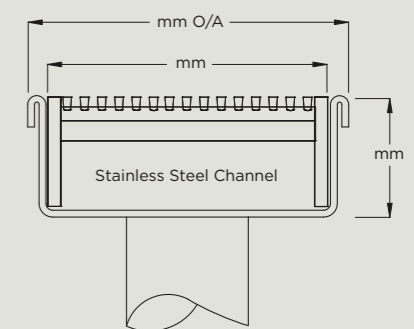

**CHANNEL**

#### PRODUCT DETAILS

For full product details, including assembly and installation information, visit our website.

#### DISTRIBUTORS

To find a distributor near you, please visit our website or call our office.

#### TECHNICAL DRAWINGS

To assist planning your project we provide complete CAD files for download from our website.

[www.stormtech.com.au](http://www.stormtech.com.au)

**Telephone** 1300 653 403

**Email** [info@stormtech.com.au](mailto:info@stormtech.com.au)