

Architecturally Designed for the Inspired Kitchen, Cabinet & Bathroom Pulls

The New Euro '08 Collection has arrived...

The latest styles and designs from Europe's leading manufactures including Confalonieri of Italy, Egoki of Spain & Furnipart of Denmark just to name a few.

Bellevue Imports Pty Ltd.

Delivering the Highest Quality & Latest in European Designed & Manufactured Architectural Hardware

Call 1300 369 395, www.Bellevueimports.com.au or email info@bellevueimports.com.au for more information

Inspiration.....

For as long as we can remember we have been striving to create, design and build. Our conscious effort to better ourselves; willingness to take risks has separated us from the rest.

“We look, we touch, we consider and we are inspired”

For over 21 years Bellevue has also been inspired...Inspired to source and stock from all over the world products that create visual attraction and differentiation without compromising quality, design or affordability.

Today Bellevue has represented nothing but the best in architecturally inspired hardware and accessories. The relationship between design and form, form and function, aesthetics and practicality are all symbiotic.

The creation of a handle is more than the handle itself; it's the connection provided between its form and its function; its personality and its aesthetic appeal; its design and the environment. Quality & design are cultural; inspired by generations past.

The importance of the handle cannot be underestimated. It is an indispensable object; it can hinder ones advance or facilitate movement in spaces of everyday life. Without it, we would have to redefine our entire way of life.

Relevant is also the handle size. It is a small sculpture; a point of difference of visual attraction on surfaces that are all too often anonymous or redundant. The opening and closing of a door is a highly symbolic gesture which has not lost its meaning over time; taking design by the hand.

A key distinction of the Bellevue name is the significant number of interpretations of the “design” concept. The modern handle lives somewhere in the middle of the equation, geometry and the organic; the practical and the inspired.

A handles form is unique, a challenge to design and create. It represented personality and function in its truest form. Inspires designs, their materialization and transformation into a handle is evident in the number of designs which exist in the Bellevue range.

“Inspiration is true design,embrace it”

About Bellevue

1983.....

In 1983 while renovating his own home Aron Midler (founder of Bellevue Imports) experienced something I am sure was not uncommon at the time; the inability to find high quality and uniquely designed architectural furniture.

Frustrated with what he did find, Aron spoke to a number of leading Architects and Interior Designers who all agreed that the Australian market could benefit significantly if products available overseas were available locally.

Recognising the gap in the Australian market place for these types of uniquely designed products, he took the opportunity to work with the leading manufacturer of Kitchen and Cabinet Handles available; Confalonieri and Cosma of Italy, Didheya of Spain, Omp Porro of Italy, Leitner of Austria as well as many others from all over the world to form Bellevue Imports.

Today.....

For over 21 years Bellevue Imports has been providing Australia and New Zealand with the best and most extensive range of architectural hardware and accessories available, all of which have been, and are recognised as world class in quality, design and craftsmanship.

Since Bellevue's inception Aron's commitment in bringing to Australia the newest and most comprehensive range of architectural products has not wavered.

To date Bellevue has supplied countless projects, from Kitchen renovations, cabinet makers, new homes and residential renovations to apartments, large commercial projects and resorts.

Bellevue's products are available Australia and New Zealand wide from various of resellers or on a direct basis (based on location). For your nearest reseller location, please visit our web site at www.BellevueImports.com.au

Bellevue is proud to be a leader in the architectural cabinet furniture market and will continue its tradition to provide products that are unique, visually distinctive, affordable and just as importantly, stocked locally, in quantity.

Euro '08 Collection - Flat Cabinet Pull Range

Art:	E155			
Size	Length	Height	Centres	Projection
A	250mm	8mm	224mm	32mm
Finish	Chrome, Satin Nickel			



Art:	E156			
Size	Length	Height	Centres	Projection
A	250mm	8mm	224mm	32mm
Finish	Chrome, Satin Nickel			



Art:	A6645			
Size	Length	Height	Centres	Projection
A	330mm	8mm	160mm	30mm
B	250mm	8mm	160mm	30mm
Finish	Chrome, Satin Nickel			

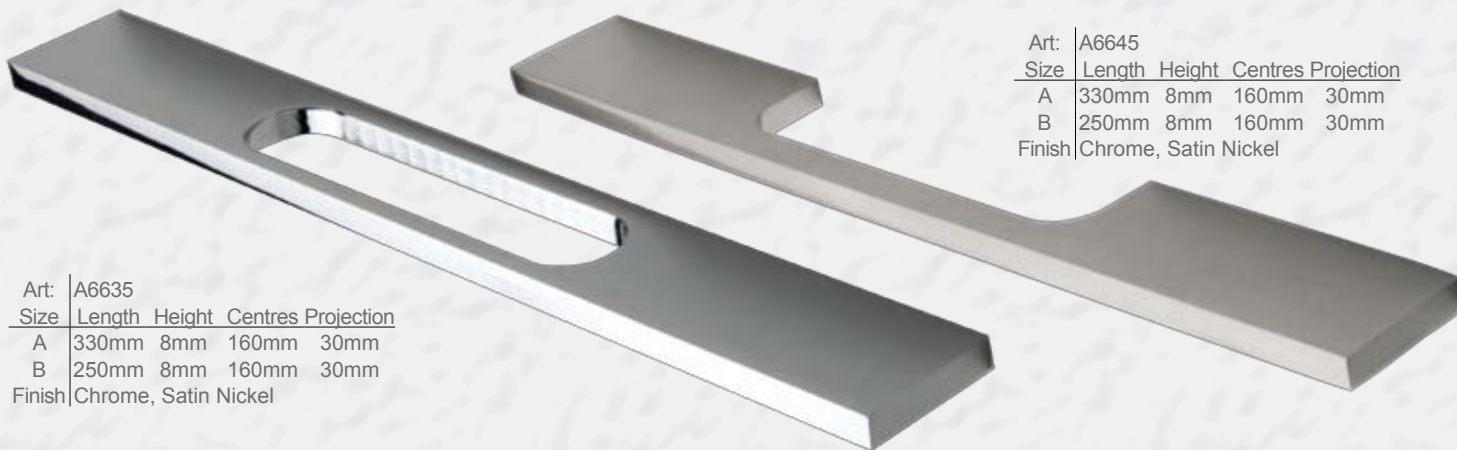

Art:	A6635			
Size	Length	Height	Centres	Projection
A	330mm	8mm	160mm	30mm
B	250mm	8mm	160mm	30mm
Finish	Chrome, Satin Nickel			

Art:	W454			
Size	Length	Height	Centres	Projection
A	800mm	12mm	736mm	30mm
B	500mm	12mm	352mm	30mm
C	400mm	12mm	288mm	30mm
Finish	Chrome, SAA			

*Long lengths up to 800mm
Ideal for Pot Draws*

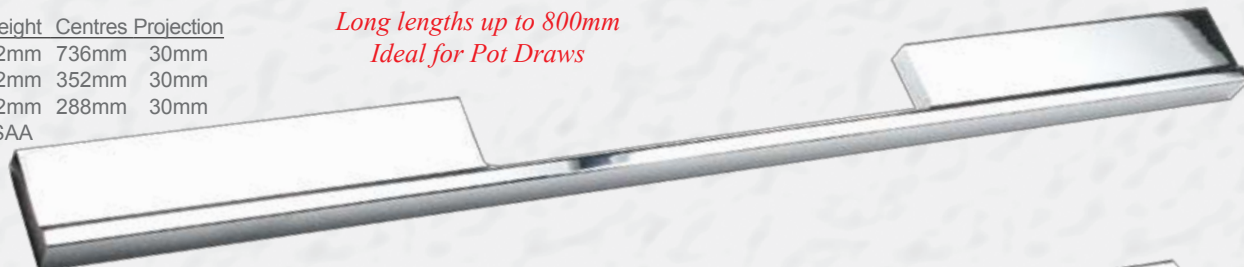

Art:	W455			
Size	Length	Height	Centres	Projection
A	500mm	12mm	288 & 160mm	30mm
B	400mm	12mm	224 & 160mm	30mm
C	300mm	12mm	128 & 160mm.	30mm
Finish	Chome, SAA			

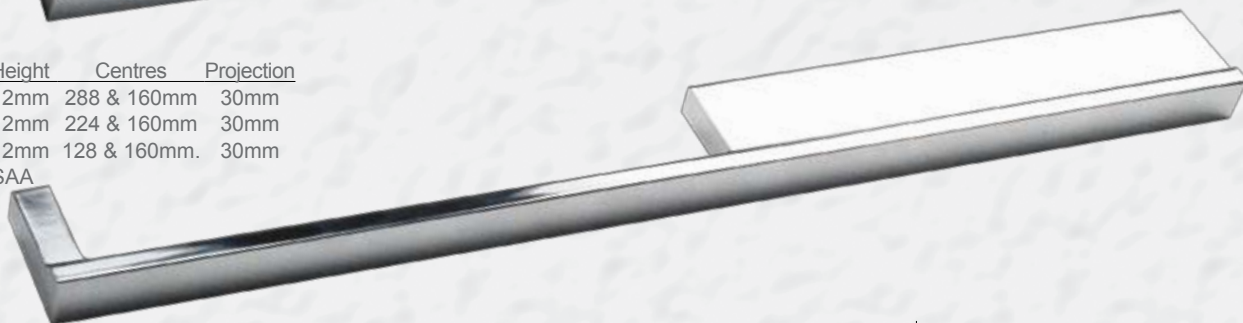

Art:	A6230			
Size	Length	Height	Centres	Projection
A	384mm	10mm	320mm	30mm
B	288mm	10mm	224mm	30mm
C	192mm	10mm	128mm	30mm
Finish	Chome, Satin Nickel			



Art:	Z9204			
Size	Length	Height	Centres	Projection
A	327mm	8mm	320mm	40mm
B	199mm	8mm	192mm	40mm
Finish	Chrome, Satin Nickel			

Euro '08 Collection - Flush Cabinet Pull Range



Art:	S3001		
Size	Length	Height	
	23mm	52mm	
Finish	Chrome, Satin Nickel		



Art:	S3002		
Size	Length	Height	
	23mm	52mm	
Finish	Chrome, Satin Nickel		

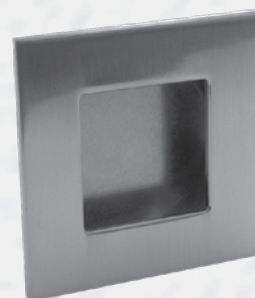

Art:	301156		
Size	Length	Height	
	49mm	50mm	
Finish	Chrome, Satin Nickel		



Art:	Z9305			
Size	Length	Height	Centres	
	58mm	71mm	32mm	
Finish	Chrome, Satin Nickel			



Art:	60587			
Size	Length	Height		
A	30mm	40mm		
Finish	Chrome, Satin Nickel, Brass			



Art:	60587A			
Size	Length	Height		
A	30mm	40mm		
Finish	Chrome, Satin Nickel, Brass			



Art:	Z9303			
Size	Length	Height	Centres	
A	118mm	59mm	96mm	
B	80mm	43mm	64mm	
Finish	Chrome, Satin Nickel			



Art:	BI60 or BI70			
BI70	70mm Diameter, Depth 15mm			
BI60	60mm Diameter, Depth 15mm			
Finish	Chrome, Satin Nickel, Brass			



Art:	60595/50 or 60595/40			
/50	50mm Diameter, Depth 10mm			
/40	40mm Diameter, Depth 10mm			
Finish	Chrome, Satin Nickel, Brass			

Pull Handles - Ideal for draws and cupboards



Art:	70978 - <i>by Confalonieri of Italy</i>			
Size	Length	Height	Projection	
A	137mm	69mm	4 & 10mm	
B	69mm	69mm	4 & 10mm	
Finish	Satin Nickel, Silver			

Euro '08 Collection - Flush Cabinet Pull Range

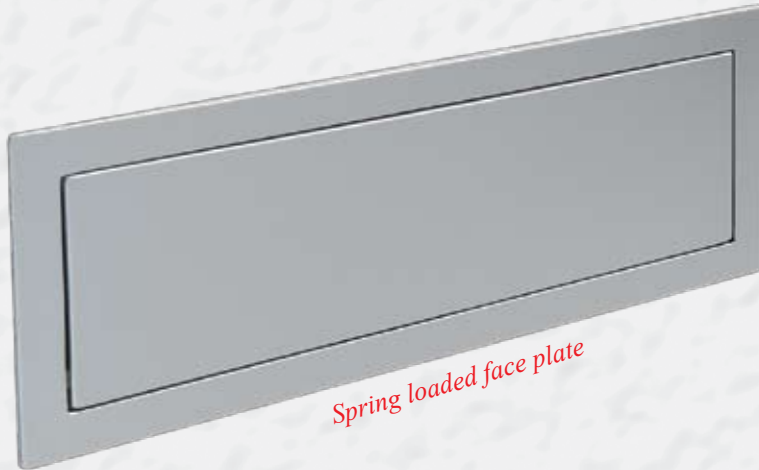

Art:	70917 <i>by Confalonieri of Italy</i>		
Size	Length	Height	
A	154mm	56mm	
B	56mm	56mm	
Finish	Chrome, Satin Nickel, Silver		

Spring loaded face plate



Spring loaded face plate

Art:	70912 <i>by Confalonieri of Italy</i>		
Size	Length	Height	
	280mm	40mm	
Finish	Chrome, Satin Nickel		



Art:	70946 <i>by Confalonieri of Italy</i>		
Size	Length	Height	
	204mm	60mm	
Finish	Silver		



Art:	S2002			
Size	Length	Height	Centres	Projection
A	160.5mm	30.6mm	128mm	12mm
Finish	Chrome, Satin Nickel			

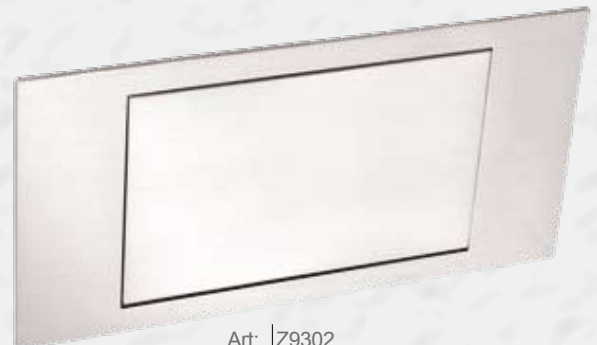

Art:	Z9302			
Size	Length	Height	Centres	
	140mm	70mm	96mm	
Finish	Chrome, Satin Nickel			

Art:	Z9300		
Size	Length	Height	
A	160mm	50mm	
B	70mm	70mm	
Finish	Chrome, Satin Nickel		



Art:	Z9301		
Size	Length	Height	
	150mm	75mm	
Finish	Silver, Satin Nickel		

Euro '08 Collection - Cabinet Pull Range

Ideal for Kitchen Drawers, Cupboards, Pot Drawers Draws



All Ideally Priced for Large Projects

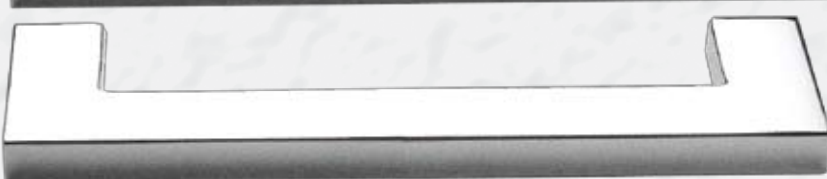
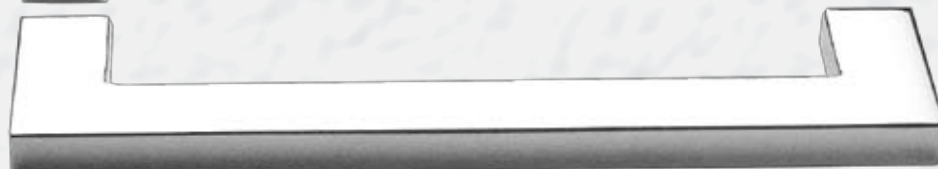

Art:	Z9207 - 8 x 14mm Flat			
Size	Length	Height	Centres	Projection
A	463mm	8mm	448mm	34mm
B	271mm	8mm	256mm	34mm
C	207mm	8mm	192mm	34mm
D	143mm	8mm	128mm	34mm
Finish	Chrome, Satin Nickel			

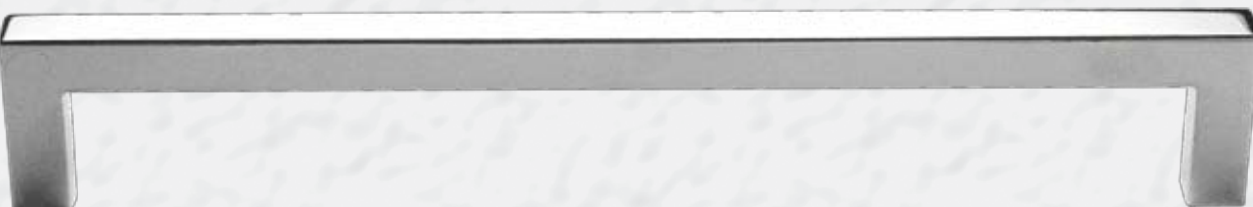

7 Sizes to choose from - 106 up to 458mm



Art:	Z9206 - 10 x 10mm Square			
Size	Length	Height	Centres	Projection
A	458mm	10mm	448mm	30mm
B	330mm	10mm	320mm	30mm
C	234mm	10mm	224mm	33mm
D	202mm	10mm	192mm	30mm
E	170mm	10mm	160mm	30mm
F	138mm	10mm	128mm	30mm
G	106mm	10mm	96mm	30mm
Finish	Chrome, Satin Nickel			



Art:	Z9208 - 14 x 14mm Square			
Size	Length	Height	Centres	Projection
A	526mm	14mm	512mm	42mm
B	462mm	14mm	448mm	42mm
C	334mm	14mm	320mm	42mm
D	238mm	14mm	224mm	42mm
E	206mm	14mm	192mm	42mm
F	174mm	14mm	160mm	42mm
Finish	Satin Stainless Steel			

Euro Collection - Cabinet Pull Range

Ideal for Drawers, Pot Drawers, Pantry or Fridge Doors



Art:	650584			
Size	Length	Height	Centres	Projection
A	348mm	20mm	320mm	27mm
B	226mm	20mm	192mm	27mm
C	162mm	20mm	128mm	27mm
Finish	Satin Nickel			

All Ideally Priced for Large Projects

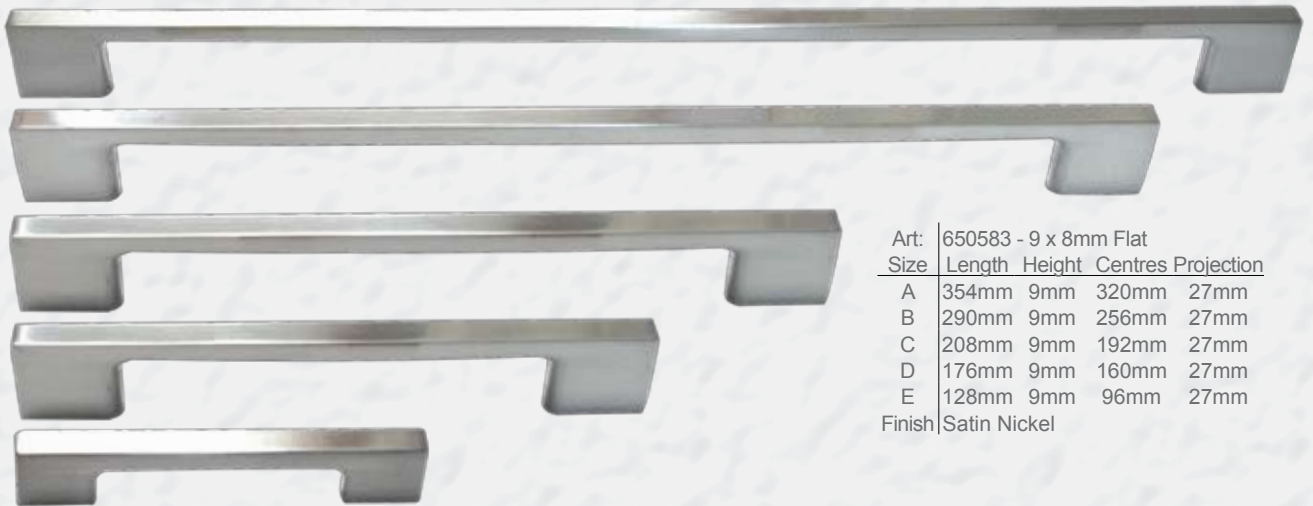

Art:	650583 - 9 x 8mm Flat			
Size	Length	Height	Centres	Projection
A	354mm	9mm	320mm	27mm
B	290mm	9mm	256mm	27mm
C	208mm	9mm	192mm	27mm
D	176mm	9mm	160mm	27mm
E	128mm	9mm	96mm	27mm
Finish	Satin Nickel			



Art:	89420 - 8 x 8mm Square			
Size	Length	Height	Centres	Projection
A	328mm	8mm	320mm	27mm
B	200mm	8mm	192mm	27mm
C	168mm	8mm	160mm	27mm
D	104mm	8mm	96mm	27mm
Finish	Satin Nickel			

Euro '08 Collection - Cabinet Pull Range

New Designs and Sizes from Europe
Ideal for Drawers, Pot Drawers, Pantry or Fridge Doors

Long lengths up to 1106mm

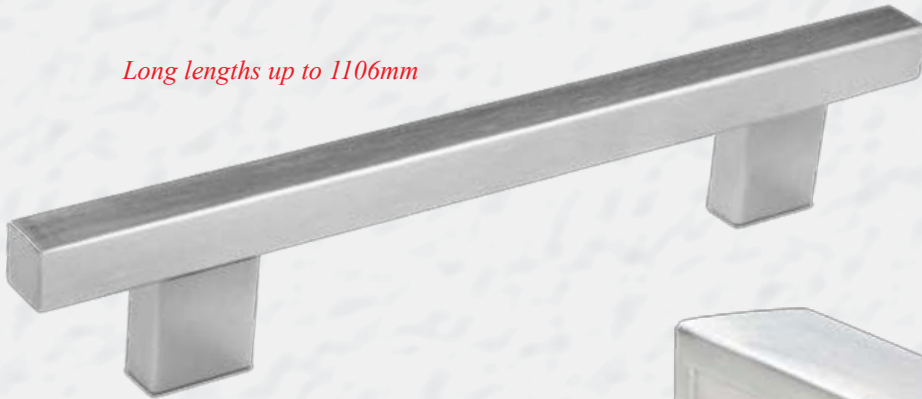

Art:	E1029 - 12 x 12mm Square			
Size	Length	Height	Centres	Projection
A	1106mm	12mm	1042mm	37mm
B	806mm	12mm	742mm	37mm
C	706mm	12mm	642mm	37mm
D	506mm	12mm	442mm	37mm
E	384mm	12mm	320mm	37mm
F	356mm	12mm	292mm	37mm
Finish	Satin Stainless Steel			

Art:	70996 - by Confalonieri of Italy			
Size	Length	Height	Centres	Projection
A	1007mm	15mm	992mm	43mm
B	515mm	15mm	500mm	43mm
C	335mm	15mm	320mm	43mm
D	239mm	15mm	224mm	43mm
Finish	Satin Stainless Steel			



Long lengths up to 10076mm

Art:	S2006			
Size	Length	Height	Centres	Projection
A	490mm	40mm	480mm	40mm
B	330mm	40mm	320mm	40mm
C	234mm	40mm	224mm	40mm
D	202mm	40mm	192mm	40mm
E	170mm	40mm	160mm	40mm
Finish	Satin Stainless Steel			



Long lengths up to 700mm

Art:	83974			
Size	Length	Height	Centres	Projection
A	700mm	12mm	622mm	29mm
B	400mm	12mm	322mm	29mm
C	200mm	12mm	122mm	29mm
Finish	SAA 12mm Square			



Art:	TA0227			
Size	Length	Height	Centres	Projection
A	370mm	8mm	320mm	34mm
B	273mm	8mm	224mm	34mm
C	210mm	8mm	160mm	34mm
D	177mm	8mm	128mm	34mm
E	145mm	8mm	96mm	34mm
Finish	Satin Nickel 8mm Square			



*Long lengths up to 800mm
Ideal for Pot Draws*

Art:	650627			
Size	Length	Height	Centres	Projection
A	320mm	25mm	310mm	30mm
B	160mm	25mm	150mm	30mm
Finish	Chrome / SAA			

Art:	47584			
Size	Length	Height	Centres	Projection
A	340mm	8mm	320mm	31mm
B	150mm	8mm	128mm	31mm
C	86mm	8mm	64mm	31mm
Finish	Chrome, Satin Chrome, Matt Nickel			

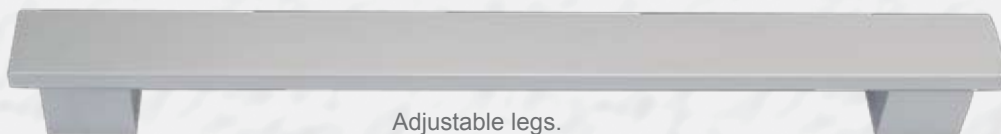

Adjustable legs.



Ideal for replacing existing handles no matter what the hole centres are. Just slide the legs to the appropriate position and lock into place.

Art:	70964 - by Confalonieri of Italy			
Size	Length	Height	Centres	Projection
A	345mm	25mm	custom	26mm
B	281mm	25mm	custom	26mm
Finish	Chrome, Silver			

Euro Collection - Cabinet Pull Range

Art:	12515			
Size	Length	Height	Centres	Projection
A	144mm	25mm	128mm	24mm
H	208mm	25mm	192mm	24mm
Finish	Silver, Chrome, Satin Nickel			



All Ideally Priced for Large Projects



Art:	301191			
Size	Length	Height	Centres	Projection
	166mm	20mm	160mm	30mm
Finish	Chrome, Satin Nickel			

Art:	301019			
Size	Length	Height	Centres	Projection
	135mm	12mm	128mm	27mm
Finish	Chrome, Satin Nickel			



Art:	301138			
Size	Length	Height	Centres	Projection
	193mm	7mm	180mm	29mm
Finish	Chrome, Satin Nickel			

Art:	12382G			
Size	Length	Height	Centres	Projection
	198mm	12mm	159mm	29mm
Finish	Chrome, Satin Nickel, Silver			



Art:	301137			
Size	Length	Height	Centres	Projection
	96mm	14mm	90mm	24mm
Finish	Chrome, Satin Nickel			



Art:	12496			
Size	Length	Height	Centres	Projection
A	150mm	9mm	128mm	27mm
Finish	Chrome, Silver, Satin Nickel			



Art:	49090			
Size	Length	Height	Centres	Projection
A	395mm	15mm	384mm	35mm
B	140mm	15mm	128mm	35mm
C	76mm	15mm	64mm	35mm
Finish	SAA			



Euro '08 - Collection

Art:	E4010			
Size	Length	Height	Centres	Projection
A	232mm	7mm	192mm	40mm
B	168mm	7mm	128mm	40mm
C	136mm	7mm	96mm	40mm
D	40mm	7mm		40mm
Finish	Chrome, Satin Nickel, SAA			



Art:	650443			
Size	Length	Height	Centres	Projection
	54mm	5mm	32mm	42mm
Finish	Powder Coat Satin Chrome			



Art:	217021			
Size	Length	Height	Centres	Projection
	44mm	1.5mm	32mm	46mm
Finish	Chrome, Silver, Matt Nickel			

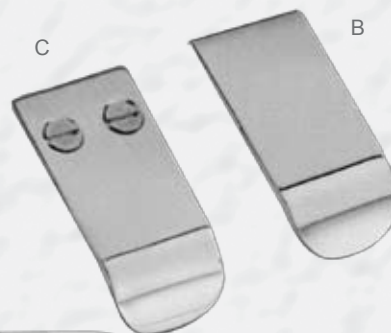

Art:	70864 - by Confalonieri of Italy		
Size	Length	Height	Projection
B	22mm	2mm	48mm
C	22mm	2mm	50mm
Finish	Chrome, Satin Chrome, Brass		

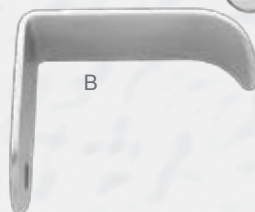

Art:	E4081			
Size	Length	Height	Centres	Projection
A	160mm	5mm	128mm	35mm
B	96mm	5mm	64mm	35mm
C	32mm	5mm	16mm	35mm
Finish	Chrome, Satin Nickel			



Art:	Z9205			
Size	Length	Height	Centres	Projection
A	237mm	45mm	192mm	34mm
B	45mm	16mm	34mm	
Finish	Chrome, Satin Nickel			



Art:	W441			
Size	Length	Height	Centres	Projection
A	118mm	9mm	96mm	30mm
B	55mm	9mm	32mm	30mm
Finish	Chrome, Satin Nickel			



Art:	Z9200			
Size	Length	Height	Centres	Projection
A	511mm	9mm	448mm	35mm
B	383mm	9mm	320mm	35mm
C	255mm	9mm	192mm	35mm
Finish	Chrome, Satin Nickel			

Long lengths up to 511mm

Angled down with a with a recessed finger grip

Euro '08 Collection



Under Side is Hollow for Grip



Corner View

Art:	89040			
Size	Length	Height	Centres	Projection
A	330mm	25mm	320mm	27mm
B	170mm	25mm	160mm	27mm
C	74mm	25mm	64mm	27mm
Finish	Satin Nickel			



Art:	12485B			
Size	Length	Height	Centres	Projection
B	120mm	25mm	96mm	25mm
Finish	Chrome, Satin Nickel			



Art:	216958			
Size	Length	Height	Centres	Projection
	39mm	7mm	32mm	17mm
Finish	Chrome, Silver			



Art:	E016		
Size	Length	Height	Projection
A	25mm	25mm	30mm
B	20mm	20mm	28mm
C	15mm	15mm	25mm
Finish	Satin Stainless Steel		



Art:	12586C			
Size	Length	Height	Centres	Projection
C	80mm	25mm	64mm	21mm
Finish	Chrome, Satin Nickel, Silver			



Art:	E207			
Size	Length	Height	Centres	Projection
	44mm	27mm	16mm	20mm
Finish	Chrome, Satin Nickel			

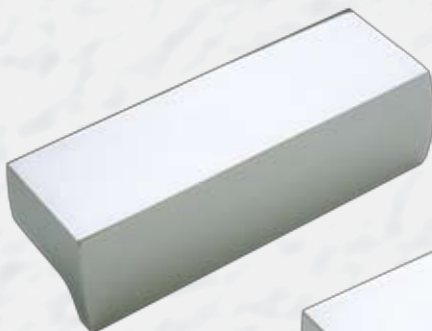

Art:	301055		
Size	Length	Height	Projection
	25mm	25mm	25mm
Finish	Chrome, Satin Nickel		



Art:	591126			
Size	Length	Height	Centres	Projection
	126mm	14mm	96mm	18mm
Finish	Silver, Nickel			

Art:	301152			
Size	Length	Height	Centres	Projection
A	59mm	18mm	50mm	20mm
B	30mm	18mm	20mm	20mm
Finish	Chrome, Satin Nickel			



Art:	591052			
Size	Length	Height	Centres	Projection
	52mm	14mm	32mm	18mm
Finish	Silver, Nickel			

Art:	40757		
Size	Length	Height	Projection
	16mm	16mm	32mm
Finish	Silver		

Euro '08 Collection



Art:	Z9210			
Size	Length	Height	Centres	Projection
	108mm	14mm	64mm	25mm
Finish	Chrome, Satin Nickel			



Art:	Z9209			
Size	Length	Height	Centres	Projection
	190mm	14.5mm	128mm	25mm
Finish	Chrome, Satin Nickel			



Art:	Z9202			
Size	Length	Height	Centres	Projection
A	365mm	13mm	320mm	39mm
B	218mm	13mm	192mm	39mm
Finish	Chrome, Satin Nickel			



Art:	A6845			
Size	Length	Height	Centres	Projection
A	395mm	10mm	352mm	36mm
B	270mm	10mm	224mm	36mm
C	165mm	10mm	128mm	36mm
Finish	Chrome, Satin Nickel			



Art:	70156 - <i>by Confalonieri of Italy</i>			
Size	Length	Height	Centres	Projection
A	239mm	10mm	192mm	37mm
B	175mm	10mm	128mm	37mm
C	47mm	10mm	-	37mm
Finish	Chrome, Satin Nickel			



Art:	A6905			
Size	Length	Height	Centres	Projection
	195mm	8mm	160mm	34mm
Finish	Chrome, Satin Nickel			



Art:	S2001			
Size	Length	Height	Centres	Projection
A	232mm	20mm	224mm	30mm
B	152mm	20mm	128 or 96mm	30mm
Finish	Chrome, Satin Nickel			



Art:	Z9201			
Size	Length	Height	Centres	Projection
A	360mm	8mm	320mm	30mm
B	200mm	8mm	160mm	30mm
Finish	Chrome, Satin Nickel			

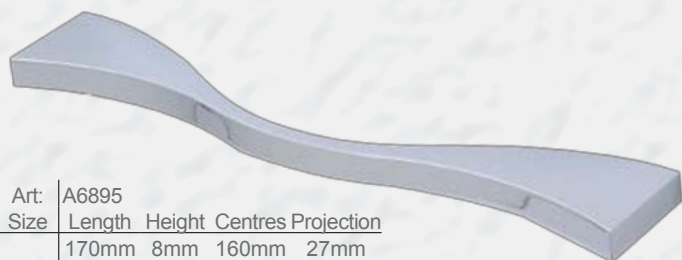

Art:	A6895			
Size	Length	Height	Centres	Projection
	170mm	8mm	160mm	27mm
Finish	Chrome, Satin Nickel			

Euro '08 Collection

*A versatile range of cabinet hardware that works horizontally or vertically.
Its all about design...be creative*

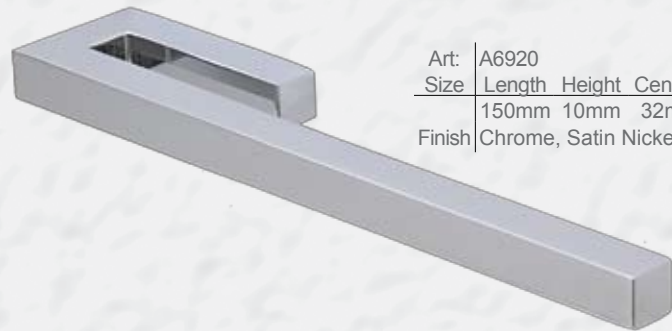

Art:	A6920			
Size	Length	Height	Centres	Projection
	150mm	10mm	32mm	30mm
Finish	Chrome, Satin Nickel			

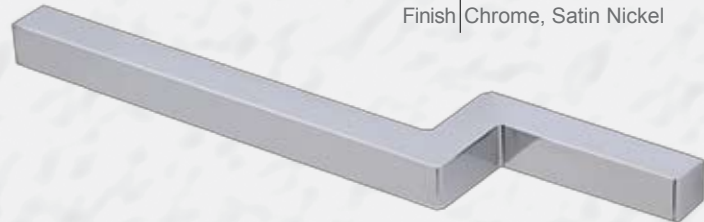

Art:	A6940			
Size	Length	Height	Centres	Projection
	150mm	10mm	32mm	30mm
Finish	Chrome, Satin Nickel			



Art:	A6950			
Size	Length	Height	Centres	Projection
	171mm	16mm	32mm	34mm
Finish	Chrome, Satin Nickel			

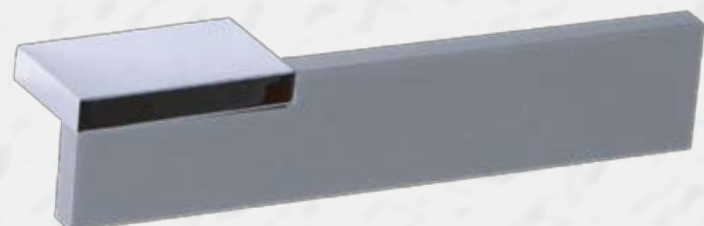

Art:	A6956			
Size	Length	Height	Centres	Projection
	150mm	30mm	32mm	30mm
Finish	Satin Nickel and Chrome			

Euro '08 Collection



Art:	70101 - <i>by Confalonieri of Italy</i>			
Size	Length	Height	Centres	Projection
A	180mm	23mm	32mm	23mm
B	94mm	20mm	16mm	21mm
Finish	Chrome, Satin Nickel			



Art:	A5920			
Size	Length	Height	Centres	Projection
	128mm	17 & 45mm	16mm	46mm
Finish	Chrome, Satin Nickel			



Art:	A5740			
Size	Length	Height	Centres	Projection
	160mm	35mm	16mm	28mm
Finish	SAA			



Art:	Z9203			
Size	Length	Height	Centres	Projection
	142mm	58mm	128mm	25mm
Finish	Chrome, Satin Nickel			



Art:	A5730			
Size	Length	Height	Centres	Projection
A	295mm	35mm	256mm	28mm
B	231mm	35mm	192mm	28mm
C	167mm	35mm	128mm	28mm
Finish	SAA			



Art:	A6125			
Size	Length	Height	Centres	Projection
	135mm	12mm	16mm	30mm
Finish	Chrome with Satin Nickel, Chrome with Brown Timber Resin			



Art:	A6400			
Size	Length	Height	Centres	Projection
A	228.5mm	20mm	128mm	26.5mm
B	164.5mm	20mm	64mm	26.5
Finish	Chrome with Satin Nickel			



Art:	A6660			
Size	Length	Height	Centres	Projection
A	301mm	13mm	288mm	37mm
B	205mm	13mm	192mm	37mm
C	141mm	13mm	128mm	37mm
Finish	Chrome with Satin Nickel, Chrome with Brown Timber Resin			



Art:	A6000			
Size	Length	Height	Centres	Projection
A	338mm	13mm	288mm	37mm
B	242mm	13mm	192mm	37mm
C	178mm	13mm	128mm	37mm
Finish	Chrome with Satin Nickel, Chrome with Brown Timber Resin			



Art:	A6820			
Size	Length	Height	Centres	Projection
B	240mm	35 & 16mm	224mm	27mm
C	170mm	35 & 16mm	160mm	27mm
Finish	Chrome, Satin Nickel			

Euro '08 Collection - Transparent Range

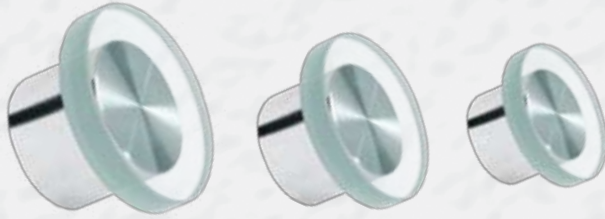

Art:	Z9100
Size	
A	60 x 27mm Diameter, 40mm Diameter Base
B	45 x 27mm Diameter, 30mm Diameter Base
C	34 x 27mm Diameter, 20mm Diameter Base
Finish	Chrome with Clear Glass



Art:	Z9102
Size	Length Height Centres Projection
A	212mm 50mm 192mm 38mm
B	212mm 40mm 192mm 38mm
C	50mm 50mm 32mm 38mm
Finish	Satin Nickel and Glass



Art:	Z9101
Size	Length Height Centres Projection
A	222mm 48mm 160mm 38mm
B	48mm 48mm 38mm
Finish	Chrome and Glass



Art:	W585
Size	Length Height Centres Projection
	234mm 32mm 224mm 29mm
Finish	Chrome and Glass



Art:	W596
Size	Length Height Centres Projection
A	231mm 34mm 192mm 29mm
B	64mm 34mm 16mm 29mm
C	32mm 34mm 16mm 29mm
Finish	Chrome and Glass

Euro '08 Collection - Timber Range



Art:	A6000			
Size	Length	Height	Centres	Projection
A	338mm	13mm	288mm	37mm
B	242mm	13mm	192mm	37mm
C	178mm	13mm	128mm	37mm
Finish	Chrome with Satin Nickel, Chrome with Brown Timber Resin			



Art:	A6660			
Size	Length	Height	Centres	Projection
A	301mm	13mm	288mm	37mm
B	205mm	13mm	192mm	37mm
C	141mm	13mm	128mm	37mm
Finish	Chrome with Satin Nickel, Chrome with Brown Timber Resin			

Art:	A6125			
Size	Length	Height	Centres	Projection
	135mm	12mm	16mm	30mm
Finish	Chrome with Satin Nickel, Chrome with Brown Timber Resin			



Art:	L881			
Size	Length	Height	Centres	Projection
A	429mm	13mm	416mm	33mm
B	237mm	13mm	224mm	33mm
C	141mm	13mm	128mm	33mm
Finish	Wenge / Satin chrome			

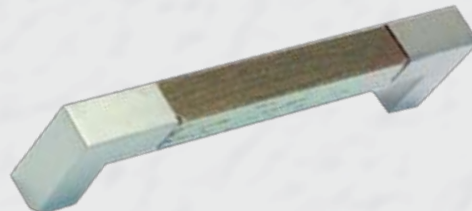

Art:	L013			
Size	Length	Height	Centres	Projection
A	180mm	10mm	128mm	27mm
B	100mm	10mm	64mm	27mm
C	50mm	10mm	32mm	27mm
Finish	Oak with SAA			



Euro '08 Collection - Knob and Finger Pull Range



Art: Z9212

Size	Diam	Centres	Projection
A	55mm	32mm	26mm
B	30mm		26mm

 Finish | Chrome, Satin Nickel



Art: W356

Size	Diam	Centres	Projection
	46mm	Single or	30mm
		16mm	

 Finish | Chrome, Satin Nickel



Art: W221

Size	Diam	Centres	Projection
	24mm		23mm

 Finish | Chrome, Satin Nickel

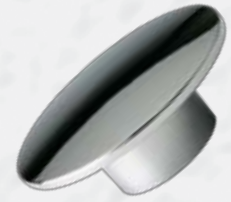

Art: E2087

Size	Diam	Centres	Projection
	60mm	16mm	23mm

 Finish | Chrome, Satin Nickel



Art: E2086

Size	Length	Height	Centres	Projection
A	60mm	60mm	16mm	23mm

 Finish | Chrome, Satin Nickel



Art: Z9211

Size	Length	Height	Centres	Projection
A	55mm	55mm	32mm	26mm

 Finish | Chrome, Satin Nickel



Art: 40789

Size	Length	Height	Centres	Projection
	36mm	50mm	32mm	29mm

 Finish | Chrome

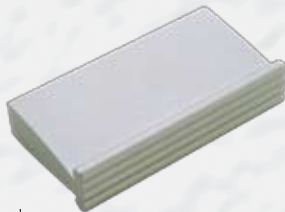

Art: 49163

Size	Length	Height	Centres	Projection
	45mm	9mm	32mm	24mm

 Finish | SAA

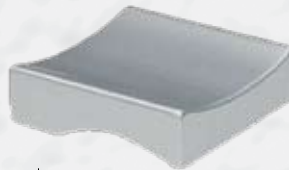

Art: 217001

Size	Length	Height	Centres	Projection
	28mm	8mm	16mm	28mm

 Finish | Chrome, Matt Nickel, Silver



Art: S2000

Size	Length	Height	Projection
A	15.5mm	15.5mm	24mm

 Finish | Chrome, Satin Nickel



Art: 60521

Size	Length	Projection
	17mm	25mm

 Finish | Chrome



Art: 12193C

Size	Length	Height	Centres	Projection
	35mm	6mm	23mm	25mm

 Finish | Chrome, Nickel, Matt Black

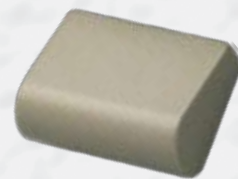

Art: 114030

Size	Length	Height	Centres	Projection
	26mm	10mm	16mm	20mm

 Finish | Nickel



Art: S3003

Size	Length	Height	Projection
	16mm	57mm	22mm

 Finish | Chrome, Satin Nickel



Art: S3005

Size	Length	Height	Projection
	16mm	52mm	17.5mm

 Finish | Chrome, Satin Nickel



Art: S3004

Size	Length	Height	Projection
	25mm	52mm	13.5mm

 Finish | Chrome, Satin Nickel



Art: 70999 - *by Confalonieri of Italy*

Size	Length	Height	Projection
	12mm	45mm	18mm

 Finish | Chrome, Satin Nickel

Euro Collection - Cabinet Pull Range



Art: 650590

Size	Length	Height	Centres	Projection
A	232mm	36mm	224mm	25mm
B	200mm	36mm	192mm	25mm
C	104mm	36mm	96mm	25mm

Finish: Satin Chrome / SAA



Art: 12569

Size	Length	Height	Centres	Projection
A	135mm	18mm	128mm	25mm
H	199mm	18mm	192mm	25mm

Finish: Silver, Satin Nickel, Chrome



Art: 41567

Size	Length	Height	Centres	Projection
	135mm	15mm	128mm	32mm

Finish: SAA, Matt Nickel



Art: 12535A

Size	Length	Height	Centres	Projection
A	157mm	19mm	128mm	25mm

Finish: Silver, Satin Nickel

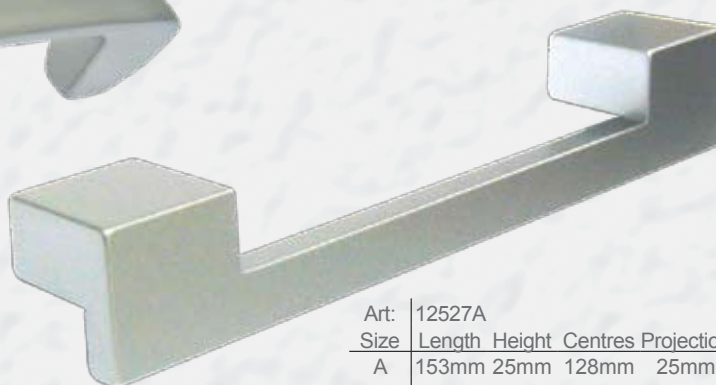

Art: 12527A

Size	Length	Height	Centres	Projection
A	153mm	25mm	128mm	25mm

Finish: Silver, Satin Nickel



Art: 301385

Size	Length	Height	Centres	Projection
	60mm	50mm	32mm	24mm

Finish: Chrome, Satin Nickel

Art: 217020

Size	Length	Height	Centres	Projection
A	160mm	40mm	96mm	24mm
B	40mm	40mm	16mm	19mm

Finish: Chrome

Euro Collection - Cabinet Pull Range



Art:	2026			
Size	Length	Height	Centres	Projection
A	257mm	10mm	224mm	40mm
B	193mm	10mm	160mm	40mm
Finish	Chrome, Satin Nickel			



A ridged underside for grip



Ribbed underside for grip

Art:	2024			
Size	Length	Height	Centres	Projection
A	405mm	2mm	320mm	30mm
B	245mm	2mm	160mm	30mm
Finish	Chrome, Satin Nickel			

Art:	12400H			
Size	Length	Height	Centres	Projection
H	220mm	20mm	192mm	30mm
Finish	Chrome, Matt Black, Satin Nickel			



Art:	40704			
Size	Length	Height	Centres	Projection
	140mm	40mm	128mm	27mm
Finish	Chrome			



Art:	46908			
Size	Length	Height	Centres	Projection
A	140mm	40mm	128mm	27mm
B	108mm	40mm	96mm	27mm
C	45mm	40mm	32mm	27mm
Finish	SAA			

Euro Collection - Cabinet Pull Range

Art:	301381			
Size	Length	Height	Centres	Projection
A	334mm	20mm	320mm	25mm
B	168mm	20mm	160mm	25mm
C	20mm	20mm		25mm
Finish	Chrome, Satin Nickel			



Long lengths up to 840mm

Ideal as Horizontal or Vertical pull handles

Art:	60401			
Size	Length	Height	Centres	Projection
A	840mm	15mm	736mm	21mm
B	540mm	15mm	448mm	21mm
C	240mm	15mm	160mm	21mm
Finish	SAA			



Ideal as Horizontal or Vertical pull handles

Long lengths up to 930mm

Art:	70980 - by Confalonieri of Italy			
Size	Length	Height	Centres	Projection
A	930mm	25mm	800mm	47mm
B	577mm	25mm	480mm	40mm
C	470mm	25mm	384mm	40mm
D	280mm	25mm	224mm	36mm
Finish	Silver			

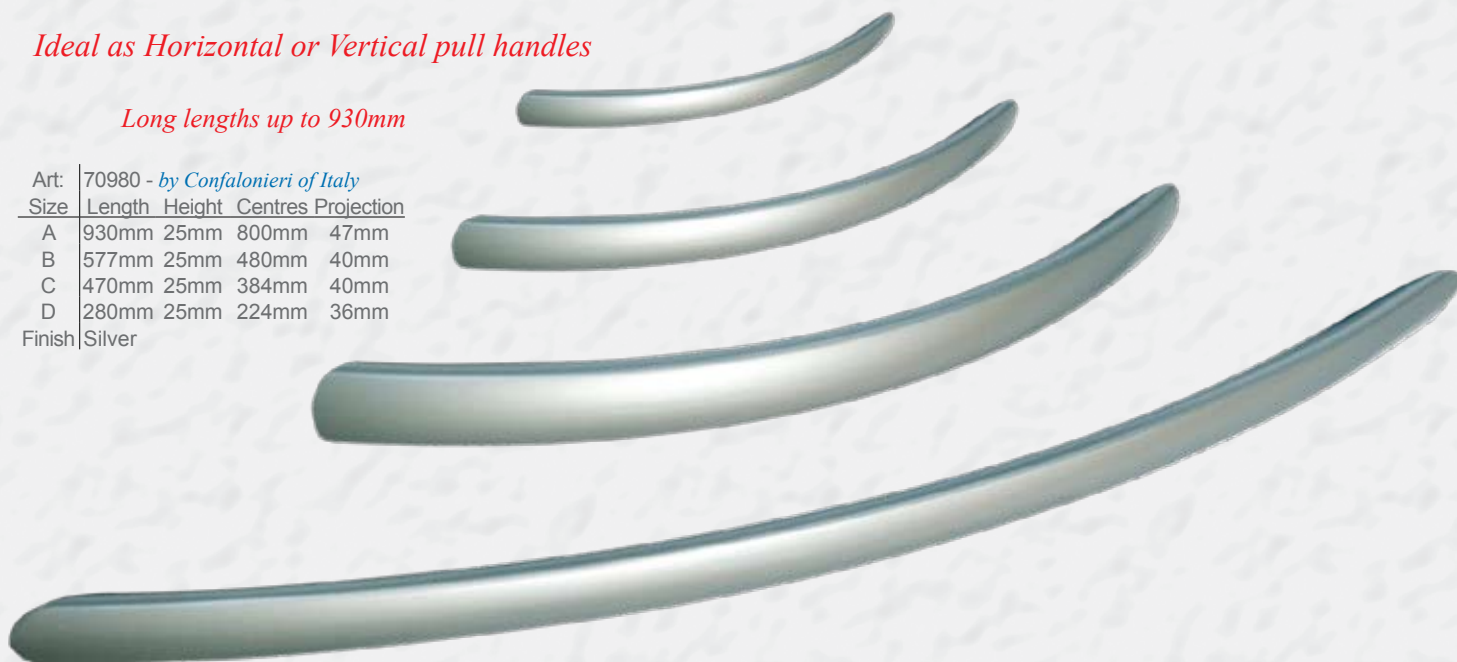

Euro Collection - Cabinet Pull Range



Art:	L292			
Size	Length	Height	Centres	Projection
A	100mm	23mm	64mm	27mm
B	42mm	23mm	32mm	27mm
C	26mm	23mm	16mm	27mm
Finish	SAA			

Side View

Art:	217022			
Size	Length	Height	Centres	Projection
A	231mm	5mm	192mm	37mm
B	167mm	5mm	128mm	37mm
Finish	Chrome, Matt Nickel, Silver			



Art:	12239			
Size	Length	Height	Centres	Projection
B	168mm	25mm	96mm	20mm
C	130mm	25mm	64mm	20mm
Finish	Satin Nickel, Matt Black			



Art:	12359B			
Size	Length	Height	Centres	Projection
	120mm	25mm	96mm	25mm
Finish	Chrome, Matt Black, Satin Nickel			



Art:	12145B			
Size	Length	Height	Centres	Projection
	70mm	3mm	32mm	28mm
Finish	Chrome, Matt Black, Satin Nickel			

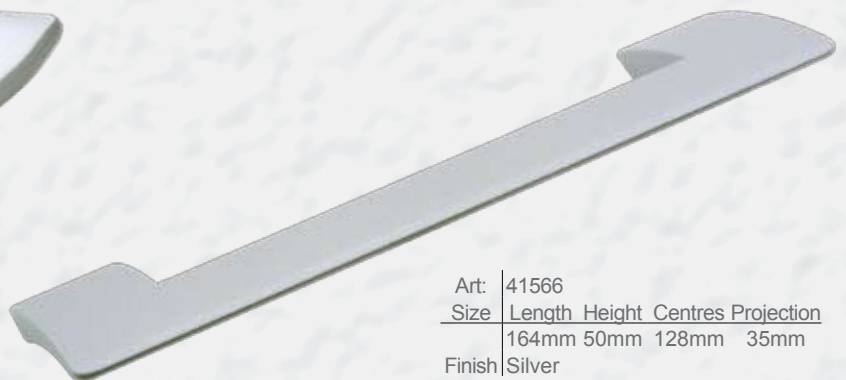

Art:	41566			
Size	Length	Height	Centres	Projection
	164mm	50mm	128mm	35mm
Finish	Silver			



Art:	12296B			
Size	Length	Height	Centres	Projection
	164mm	13mm	96mm	25mm
Finish	Matt Black, Nickel			

Art:	70969 - by Confalonieri of Italy			
Size	Length	Height	Centres	Projection
	68mm	10mm	32mm	29mm
Finish	Chrome, Satin Nickel			

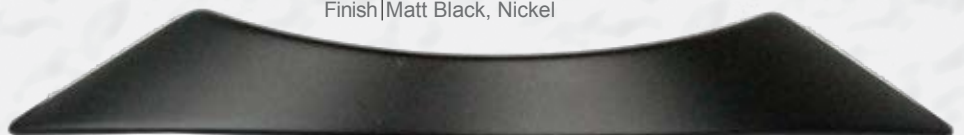

Euro Collection - Cabinet Pull Range



Art:	87211
Size	Length Height Centres Projection
Finish	171mm 45mm 160mm 2 & 12mm Powder Coat Satin Chrome



Art:	12364C
Size	Length Height Centres Projection
Finish	88mm 46mm 64mm 18mm Chrome, Satin Nickel



Art:	26001
Size	Length Height Projection
Finish	28 140mm 40mm 4 & 15mm 60 172mm 40mm 4 & 15mm 92 204mm 40mm 4 & 15mm SAA



Art:	119140
Size	Length Height Centres Projection
Finish	106mm 30mm 96mm 1 & 13mm Silver, Nickel



Art:	120140
Size	Length Height Centres Projection
Finish	139mm 40mm 128mm 2 & 15mm Chrome, Silver, Nickel



Long lengths up to 1130mm



Art:	E500
Size	Length Height Centres Projection
Finish	A 1130mm 40mm 1120mm 15mm B 330mm 40mm 320mm 15mm C 202mm 40mm 192mm 15mm E 138mm 40mm 128mm 15mm Satin Nickel

Art:	E5057
Size	Length Height Centres Projection
Finish	80mm 80mm 64mm 7 & 15mm Satin Nickel

Stainless Steel - Cabinet Pull Range

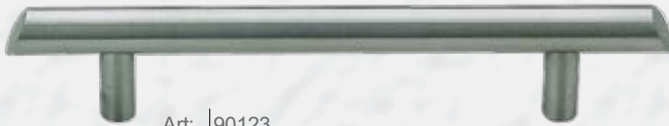

Art:	90123			
Size	Length	Height	Centres	Projection
A	176mm	10mm	128mm	26mm
B	144mm	10mm	96mm	26mm
Finish	Satin Stainless Steel			

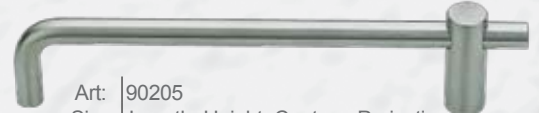

Art:	90205			
Size	Length	Height	Centres	Projection
A	120mm	5mm	96mm	31mm
B	85mm	5mm	64mm	31mm
Finish	Satin Stainless Steel			

Long lengths up to 1106mm



Art:	90159			
Size	Length	Height	Centres	Projection
A	125mm	10mm	96mm	35mm
B	90mm	10mm	64mm	35mm
Finish	Satin Stainless Steel			

Long lengths up to 1007mm

Art:	E1029			
Size	Length	Height	Centres	Projection
A	1106mm	12mm	1042mm	37mm
B	806mm	12mm	742mm	37mm
C	706mm	12mm	642mm	37mm
D	506mm	12mm	442mm	37mm
E	384mm	12mm	320mm	37mm
F	356mm	12mm	292mm	37mm
Finish	Satin Stainless Steel			



Art:	70996 - by <i>Confalonieri of Italy</i>			
Size	Length	Height	Centres	Projection
A	1007mm	15mm	992mm	43mm
B	515mm	15mm	500mm	43mm
C	335mm	15mm	320mm	43mm
D	239mm	15mm	224mm	43mm
Finish	Satin Stainless Steel			

Choice of sizes



Choice of sizes

Art:	Z9208			
Size	Length	Height	Centres	Projection
A	526mm	14mm	512mm	42mm
B	462mm	14mm	448mm	42mm
C	334mm	14mm	320mm	42mm
D	238mm	14mm	224mm	42mm
E	206mm	14mm	192mm	42mm
F	174mm	14mm	160mm	42mm
Finish	Satin Stainless Steel			

Art:	S2006			
Size	Length	Height	Centres	Projection
A	490mm	40mm	480mm	40mm
B	330mm	40mm	320mm	40mm
C	234mm	40mm	224mm	40mm
D	202mm	40mm	192mm	40mm
E	170mm	40mm	160mm	40mm
Finish	Satin Stainless Steel			

Choice of sizes



Art:	90200			
Size	Length	Height	Centres	Projection
A	448mm	12mm	384mm	35mm
B	352mm	12mm	288mm	35mm
C	256mm	12mm	192mm	35mm
D	192mm	12mm	128mm	35mm
Finish	Satin Stainless Steel 12mm Bar			

Stainless Steel - Cabinet Pull Range

Stainless Steel Cabinet Pulls are an ideal solution for external cupboards and doors. They can be used in all environments including those affected by sea air. These Cabinet Pulls are also available as back-to-back; ideal for glass shower doors etc. Contact Bellevue for more information.



Art:	E016		
Size	Length	Height Projection	
A	25mm	25mm	30mm
B	20mm	20mm	28mm
C	15mm	15mm	25mm
Finish	Satin Stainless Steel		



Art:	90325	
Size	Diameter	Projection
A	5mm	18mm
B	5mm	14mm
Finish	Satin Stainless Steel	



Art:	90129		
Size	Diameter	Projection	
A	35mm	28mm	
B	25mm	21mm	
C	20mm	18mm	
Finish	Satin Stainless Steel		



Art:	90127	
Size	Diameter	Projection
B	18mm	17mm
Finish	Satin Stainless Steel	



Art:	90126		
Size	Diameter	Projection	
A	25mm	30mm	
B	20mm	28mm	
C	15mm	26mm	
Finish	Satin Stainless Steel		



Art:	90125	
Size	Diameter	Projection
B	25mm	20mm
Finish	Satin Stainless Steel	



Art:	90158		
Size	Diameter	Projection	
A	30mm	31mm	
B	25mm	29mm	
C	20mm	25mm	
Finish	Satin Stainless Steel		



Art:	90130	
Size	Diameter	Projection
A	30mm	23mm
Finish	Satin Stainless Steel	



Art:	90209		
Size	Diameter	Projection	
A	20mm	28mm	
Finish	Satin Stainless Steel		



Art:	90326	
Size	Diameter	Projection
B	15mm	30mm
Finish	Satin Stainless Steel	



Art:	90207		
Size	Diameter	Projection	
	11mm	25mm	
Finish	Satin Stainless Steel		



Art:	90327	
Size	Diameter	Projection
A	25mm	34mm
B	15mm	24mm
Finish	Satin Stainless Steel	

Cabinet Pull Range

Art: 12311G
 Size Length Height Centres Projection
 206mm 28mm 192mm 37mm
 Finish Chrome, Satin Nickel



Art: 12181A
 Size Length Height Centres Projection
 135mm 15mm 128mm 26mm
 Finish Chrome, Satin Nickel, Black



Art: 12186
 Size Length Height Centres Projection
 139mm 15mm 128mm 27mm
 Finish Chrome Ends with Satin Insert
 Chrome Ends with Black Insert
 Chrome Ends with Nickel



Art: 12329A
 Size Length Height Centres Projection
 160mm 25mm 128mm 35mm
 Finish Chrome with Satin Nickel Insert



Art: 70956 - by Confalonieri of Italy
 Size Length Height Centres Projection
 78mm 35mm 64mm 35mm
 Finish Chrome, Satin Nickel



Art: 12385
 Size Length Height Centres Projection
 A 156mm 25mm 128mm 30mm
 B 123mm 20mm 96mm 28mm
 Finish Chrome, Satin Nickel



Art: 12297
 Size Length Height Centres Projection
 A 156mm 25mm 128mm 30mm
 B 123mm 25mm 96mm 28mm
 Finish Chrome, Satin Nickel

Art: 12124C
 Size Length Height Centres Projection
 42mm 14mm 32mm 26mm
 Finish Chrome, Brass, Nickel, Matt Black



Art: 12188A
 Size Length Height Centres Projection
 164mm 15mm 128mm 26mm
 Finish Chrome, Satin Nickel, Matt Black

Art: 12151B
 Size Length Height Centres Projection
 40mm 15mm 32mm 20mm
 Finish Chrome, Satin Nickel, Matt Black



Cabinet Pull Range

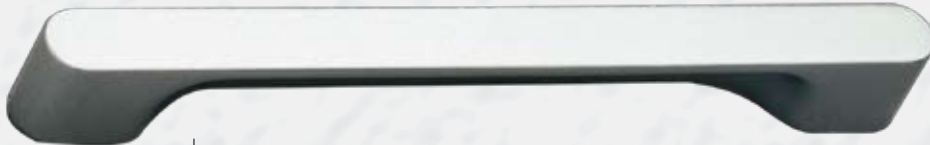

Art:	12428G			
Size	Length	Height	Centres	Projection
	170mm	14mm	160mm	23mm
Finish	Chrome, Satin Nickel			



Art:	150224 or 150320			
Size	Length	Height	Centres	Projection
320	330mm	10mm	320mm	30mm
224	234mm	10mm	224mm	30mm
Finish	Chrome, Satin Nickel, Matt Black			



Art:	12199			
Size	Length	Height	Centres	Projection
A	153mm	10mm	128mm	27mm
B	112mm	10mm	96mm	29mm
C	80mm	5mm	64mm	23mm
Finish	Chrome, Satin Nickel, Matt Black			



Art:	174197 or 174347			
Size	Length	Height	Centres	Projection
347	367mm	10mm	347mm	27mm
197	217mm	10mm	197mm	29mm
Finish	Chrome, Satin Nickel, Matt Black Gloss Black			

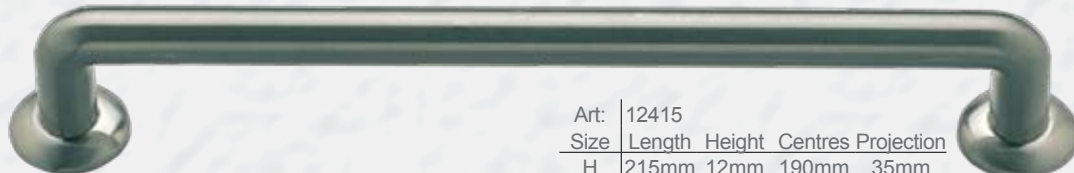

Art:	12415			
Size	Length	Height	Centres	Projection
H	215mm	12mm	190mm	35mm
G	183mm	12mm	160mm	35mm
Finish	Chrome, Satin Nickel			

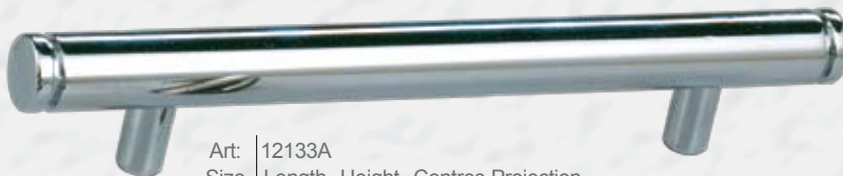

Art:	12133A			
Size	Length	Height	Centres	Projection
	190mm	15mm	128mm	30mm
Finish	Chrome, Satin Nickel			



Art:	12070B			
Size	Length	Height	Centres	Projection
	80mm	8mm	32mm	22mm
Finish	Brass, Chrome, Satin Nickel			

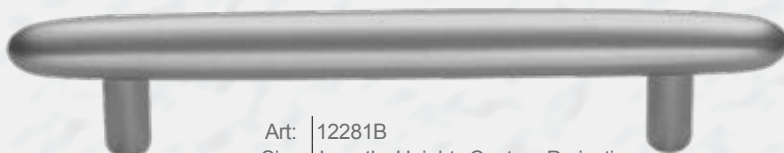

Art:	12281B			
Size	Length	Height	Centres	Projection
	137mm	15mm	96mm	28mm
Finish	Chrome, Satin Nickel, Matt Black			

Cabinet Pull Range

Art:	170160
Size	<u>Length</u> <u>Height</u> <u>Centres</u> <u>Projection</u>
	186mm 10mm 160mm 30mm
Finish	Chrome, Satin Nickel, Black, White

Art:	12101
Size	<u>Length</u> <u>Height</u> <u>Centres</u> <u>Projection</u>
A	148mm 10mm 128mm 26mm
B	113mm 10mm 96mm 24mm
C	76mm 10mm 64mm 23mm
Finish	Brass, Chrome, Silver, Satin Chrome, Black, White, Gun Metal



Art:	12134
Size	<u>Length</u> <u>Height</u> <u>Centres</u> <u>Projection</u>
A	150mm 6mm 128mm 25mm
B	114mm 6mm 96mm 18mm
Finish	Matt Black



Art:	60400
Size	<u>Length</u> <u>Height</u> <u>Centres</u> <u>Projection</u>
A	110mm 5mm 96mm 25mm
B	78mm 5mm 64mm 25mm
Finish	Brass, Chrome, Satin Nickel

Art:	12148
Size	<u>Length</u> <u>Height</u> <u>Centres</u> <u>Projection</u>
A	157mm 5mm 128mm 31mm
B	117mm 5mm 96mm 28mm
Finish	Chrome, Satin Nickel, Matt Black



Art:	12127B
Size	<u>Length</u> <u>Height</u> <u>Centres</u> <u>Projection</u>
	114mm 8mm 96mm 23mm
Finish	Chrome, Nickel, Matt Black, Gun Metal



Art:	12132
Size	<u>Length</u> <u>Height</u> <u>Centres</u> <u>Projection</u>
A	150mm 5mm 128mm 25mm
B	114mm 5mm 96mm 18mm
Finish	Chrome, Satin Nickel, White



Art:	12152A
Size	<u>Length</u> <u>Height</u> <u>Centres</u> <u>Projection</u>
	156mm 5mm 128mm 25mm
Finish	Chrome, Satin Nickel, Black



Art:	12277A
Size	<u>Length</u> <u>Height</u> <u>Centres</u> <u>Projection</u>
	154mm 10mm 128mm 27mm
Finish	Chrome, Satin Nickel, Black



Art:	12330A
Size	<u>Length</u> <u>Height</u> <u>Centres</u> <u>Projection</u>
A	162mm 16mm 128mm 25mm
Finish	Chrome, Satin Nickel, Matt Black



Cabinet Pull Range



Art:	583110
Size	Length Height Centres Projection
	130mm 5mm 96mm 26mm
Finish	Chrome, Nickel, Matt Black



Art:	583120
Size	Length Height Centres Projection
	85mm 5mm 64mm 24mm
Finish	Chrome, Nickel, Matt Black



Art:	583130
Size	Length Height Centres Projection
	50mm 5mm 32mm 17mm
Finish	Chrome, Nickel, Matt Black



Art:	4170
Size	Length Height Centres Projection
3	148mm 7mm 128mm 25mm
1	85mm 7mm 64mm 25mm
Finish	Satin Chrome, Matt Nickel



Art:	40742
Size	Length Height Centres Projection
	48mm 10mm 32mm 20mm
Finish	Pewter



Art:	584110
Size	Length Height Centres Projection
10	77mm 8mm 64mm 24mm
30	40mm 8mm 32mm 20mm
Finish	Chrome, Nickel, Gold



Art:	70833 - <i>by Confalonieri of Italy</i>
Size	Length Height Centres Projection
A	76mm 18mm 64mm 20mm
B	23mm 18mm 18mm 23mm
Finish	Chrome, Satin Nickel

Art:	60520
Size	Length Height Centres Projection
A	80mm 15mm 64mm 21mm
B	50mm 15mm 32mm 21mm
Finish	Brass, Chrome, Satin Nickel



Art:	12218C
Size	Length Height Centres Projection
	78mm 35mm 64mm 32mm
Finish	Chrome, Satin Nickel

Art:	537140
Size	Length Height Centres Projection
	90mm 5mm 32mm 19mm
Finish	Chrome, Nickel, Matt Black

Art:	12157C
Size	Length Height Centres Projection
A	80mm 9mm 64mm 24mm
Finish	Chrome, Black, White



Art:	12406E
Size	Length Height Centres Projection
	70mm 35mm 16mm 30mm
Finish	Chrome, Satin Nickel



Art:	12163
Size	Length Height Centres Projection
B	135mm 3mm 96mm 30mm
Finish	Chrome, Satin Nickel, Matt Black

Cabinet Pull Range



Art:	60105		
Size	Diameter	Projection	
A	35mm	38mm	
B	30mm	30mm	
C	25mm	28mm	
Finish	Brass, Chrome, Satin Nickel, Satin Chrome		



Art:	60163		
Size	Diameter	Projection	
A	35mm	25mm	
B	30mm	20mm	
Finish	Brass, Chrome		



Art:	60148		
Size	Diameter	Height	Projection
A	35mm	35mm	25mm
B	25mm	25mm	20mm
Finish	Brass, Satin Nickel		



Art:	11869		
Size	Diameter	Projection	
C	19mm	27mm	
D	16mm	23mm	
Finish	Chrome, Black		



Art:	23959		
Size	Diameter	Projection	
A	20mm	23mm	
B	14mm	19mm	
Finish	Brass, Chrome, Matt Black, Nickel		



Art:	23954		
Size	Length	Height	Projection
	34mm	21mm	21mm
Finish	Brass, Chrome, Satin Nickel		



Art:	60170		
Size	Diameter	Projection	
A	35mm	35mm	
B	25mm	25mm	
Finish	Brass, Chrome		



Art:	60461		
Size	Diameter	Projection	
	48mm	20mm	
Finish	Brass, Chrome, Satin Nickel		



Art:	23944		
Size	Diameter	Projection	
B	28mm	22mm	
C	25mm	20mm	
Finish	Brass, Chrome		



Art:	60444		
Size	Diameter	Height	Projection
A	20mm	33mm	24mm
Finish	Brass, Chrome, Satin Nickel		



Art:	23899		
Size	Diameter	Projection	
A	35mm	28mm	
B	30mm	24mm	
C	25mm	20mm	
Finish	Brass, Chrome		



Art:	60152		
Size	Diameter	Projection	
A	30mm	25mm	
B	25mm	20mm	
Finish	Brass, Chrome, Satin Nickel		



Cabinet Pull Range



Art:	30259		
Size	Length	Height	Projection
	30mm	13mm	24mm
Finish	Chrome, Satin Chrome		



Art:	30265		
Size	Length	Height	Projection
	30mm	30mm	24mm
Finish	Chrome, Satin Chrome		



Art:	60523		
Size	Length	Height	Projection
	30mm	27mm	25mm
Finish	Brass, Chrome, Satin Nickel, Satin Chrome		



Art:	23933A			
Size	Diameter	Height	Centres	Projection
	45mm	30mm	28mm	30mm
Finish	Chrome, Satin Nickel			



Art:	23952B	
Size	Diameter	Projection
	18mm	22mm
Finish	Brass, Chrome, Black, White	



Art:	60406		
Size	Length	Height	Projection
	20mm	48mm	18mm
Finish	Brass, Chrome, Satin Nickel		



Art:	23891	
Size	Diameter	Projection
A	30mm	35mm
B	25mm	30mm
C	20mm	25mm
Finish	Brass, Chrome, Black Chrome	



Art:	549740		
Size	Diameter	Height	Projection
	14mm	mm	21mm
Finish	Gold, Chrome, Matt Black, Nickel		



Art:	12235C		
Size	Diameter	Height	Projection
	38mm	42mm	23mm
Finish	Chrome, Matt Black, Satin Nickel		



Art:	Tube	
Size	Diameter	Projection
25	25mm	30mm
19	19mm	20mm
14	14mm	22mm
Finish	Brass, Chrome, Satin Nickel	



Art:	217000	
Size	Diameter	Projection
	24mm	32mm
Finish	Chrome, Silver, Matt Nickel	



Art:	23950C	
Size	Diameter	Projection
	13mm	23mm
Finish	Brass, Chrome, Black	



Art:	581710		
Size	Diameter	Height	Projection
	12mm	26mm	22mm
Finish	Chrome, Nickel, Matt Black		

Cabinet Pull Range



Art:	60108		
Size	Diameter	Projection	
A	28mm	28mm	
B	22mm	22mm	
Finish	Brass, Satin Nickel with Brass		



Art:	60106		
Size	Diameter	Projection	
A	28mm	30mm	
B	22mm	25mm	
Finish	Brass, Chrome / Brass, Satin Nickel / Brass		

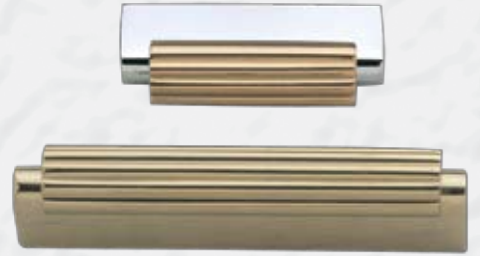

Art:	60409			
Size	Length	Height	Centres	Projection
A	80mm	12mm	64mm	20mm
B	50mm	12mm	32mm	20mm
Finish	Brass, Chrome with Brass			



Art:	12270B			
Size	Length	Height	Centres	Projection
	110mm	15mm	96mm	35mm
Finish	Satin Nickel with Chrome Brass with Chrome			



Art:	30293			
Size	Length	Height	Centres	Projection
A	80mm	12mm	64mm	20mm
Finish	Brass with satin chrome wire, Chrome with Satin Chrome wire			



Art:	30292			
Size	Length	Height	Centres	Projection
A	80mm	12mm	64mm	20mm
Finish	Brass with chrome ends			

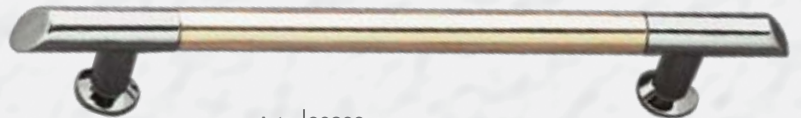

Art:	30293			
Size	Length	Height	Centres	Projection
B	145mm	10mm	96mm	28mm
Finish	Brass with Chrome Ends			



Art:	12032B			
Size	Length	Height	Projection	
	18m	50mm	20mm	
Finish	Brass, Antique Bronze			



Art:	60416			
Size	Length	Height	Centres	Projection
A	65mm	25mm	32mm	24mm
B	45mm	25mm	32mm	24mm
Finish	Chrome with Brass			



Art:	12223			
Size	Length	Height	Centres	Projection
B	135mm	14mm	96mm	27mm
C	102mm	14mm	64mm	27mm
Finish	Antique Bronze			



Art:	12208C			
Size	Length	Height	Centres	Projection
	85mm	24mm	64mm	21mm
Finish	Satin Nickel			



Art:	60161		
Size	Diameter	Projection	
A	32mm	26mm	
B	25mm	23mm	
Finish	Bronze		

Euro '08 Collection - Sliding Door Flush Pull Range



Art: 70913 - *by Confalonieri of Italy*
 Size | Height | Length
 A | 256mm | 80mm
 Finish | Chrome, Silver



Art: Z9301
 Size | Height | Length
 A | 150mm | 75mm
 Finish | Chrome, Satin Nickel



Art: 70978A-*by Confalonieri of Italy*
 Size | Height | Length
 A | 137mm | 69mm
 Finish | Satin Nickel, Silver



Art: H55
 Size | Length | Height
 A | 100mm | 50mm
 Finish | Polished Stainless, Satin Stainless



Art: D109 or D111
 Size | Height | Length
 D109 | 128mm | 37mm | Round End
 D111 | 128mm | 37mm | Square End
 Finish | Chrome, Satin Chrome, Brass

Art: TW01
 Size | Height | Length
 A | 120mm | 35mm
 Finish | Satin Stainless

Art: TW02
 Size | Height | Length
 A | 120mm | 38mm
 Finish | Satin Stainless



Art: 70989 - *by Confalonieri of Italy*
 Size | Height | Length
 A | 160mm | 31mm
 Finish | Chrome & Satin Chrome



Art: Z9300
 Size | Height | Length
 A | 160mm | 50mm
 Finish | Chrome, Satin Nickel



Art: BI150
 Size | Height | Length
 A | 150mm | 45mm
 Finish | Chrome, Satin Chrome



Art: D509
 Size | Height | Length
 A | 128mm | 37mm
 Finish | Black, White

Euro '08 Collection - Sliding Door Flush Pull & Bi Fold Range

Flush Pull & Bi Fold Range - Suitable for all sliding doors, concealed fixings, internal or external.



Art:	D129
Size	Length Height
B	65mm 65mm
Finish	Chrome, Satin Chrome, Brass



Art:	70978B - <i>by Confalonieri of Italy</i>
Size	Length Height
B	69mm 69mm
Finish	Chrome, Satin Nickel



Art:	Z9300
Size	Length Height
B	70mm 70mm
Finish	Chrome, Satin Nickel



Art:	301156
Size	Length Height
	49mm 50mm
Finish	Chrome, Satin Nickel



Art:	H28
Size	Length Height
B	76mm 76mm
Finish	Chrome, Satin Chrome



Art:	Z9304
Size	Length Height
A	118mm 59mm
B	80mm 43mm
Finish	Chrome, Satin Nickel



Art:	70946 - <i>by Confalonieri of Italy</i>
Size	Length Height
	200mm 60mm
Finish	Silver



Art:	T203
Size	90mm Diameter
Finish	Chrome, Satin Chrome



Art:	D124
Size	65mm Diameter
Finish	Chrome, Satin Chrome, Brass



Art:	BI60 or BI75
Size	60mm or 75mm Diameter
Finish	Chrome, Satin Chrome



Art:	60595
Size	50mm or 40mm Diameter
Finish	Chrome, Satin Chrome

Finger Pulls - Recessed in edge of a sliding door for when it's fully recessed into the sliding door cavity.



Art:	D126
Size	29mm Diameter
Finish	Chrome, Satin Chrome, Brass



Art:	60587
Size	Length Height
	30mm 40mm
Finish	Chrome, Satin Nickel, Brass



Art:	S3001
Size	Length Height
	23mm 52mm
Finish	Chrome, Satin Nickel



Art:	S3002
Size	Length Height
	23mm 52mm
Finish	Chrome, Satin Nickel



Euro '08 Collection - Sliding Door Flush Privacy Range

Sliding Door Privacy Sets - Concealed fixings, suitable for internal or external doors, supplied with or without lock.



D122 by Olivari

Patented design by *Nicola Novelletto*

Finish: Chrome, Satin Chrome, Brass

SuperInox (Stainless Steel), SuperInox Brass

BioChrome, BioSatin Chrome

Size: 65 x 65mm Diameter

Minimum Door Thickness 40mm



K13250 by Didheya of Spain

Finish: Polished or Satin Stainless Steel

Minimum Door Thickness 35mm



D127 by Olivari

Patented design by *Studio Olivari*

SuperInox (Stainless Steel), SuperInox Brass

BioChrome, BioSatin Chrome

Size: 65 x 65mm Diameter Suitable for sliding timber

Min Door Thickness 40mm



70978PS by Bellevue

Satin Nickel - 69 x 137mm

Suitable for sliding timber doors 38mm and up



K14250 by Didheya of Spain

Finish: Polished or Satin Stainless Steel

Minimum Door Thickness 35mm

Manufactures Profile - Gruppo Confalonieri of Italy

For over 22 years in Australia and New Zealand the name Bellevue Imports has been, and is synonymous with providing products that create visual attraction and differentiation without compromising quality, design or affordability. Bellevue's products have been used Australia and New Zealand wide, from small projects through to large (project pricing available). They are designed and manufactured by people from within the design industry; people who truly believe that design and quality are an integral part of creating something special and unique.

"The Italians; they have over 2000 years of history and culture, they know how to create something stylish, unique and memorable. Their architectural furniture is an example of their passion for creativity, simplicity and elegance in design. They do it better than anyone else, the end result is simply stunning" - Aron Midler- founder of Bellevue Imports when asked why bring Italian products to Australia.

Stylish, practical and importantly aesthetically pleasing to the eye, *Confalonieri* of Italy's products are considered by the design industry to be best in class for quality, affordability and design. As a result, they have been used worldwide in kitchens, offices, hotels, hospitals, residential & commercial applications of all types. With its' factory located in Italy & over 50 years of experience, *Confalonieri* is considered a world leader when it comes to the design needs of today, and tomorrow.

Bellevue is proud of its long association with *Confalonieri*, and will continue its association well into the future. Today *Confalonieri* is considered to be a leader and innovator in design and quality of Architectural furniture in Europe. For more than 50 years, *Confalonieri* has been recognised as an innovative manufacturer who has a history of pursuing excellence. Confalonieris' success is founded on a commitment to continually invest in research and technology; guaranteeing that their products will always meet the highest quality and design standards.

Design and quality are symbiotic, they go hand in hand.



The Confalonieri Factory in Italy

The complete *Confalonieri* range is available Australia and New Zealand wide from a range of resellers. Delivery is typically overnight to most locations. Bellevue welcomes any organisations interested in becoming a reseller of the *Confalonieri* range as well as any other products available from Bellevue Imports. For a complete list of resellers, please look at our web site at www.bellevueimports.com.au or alternatively call us on 1300 369 395 to discuss your requirements.





Bellevue Imports Pty Ltd

954 Glenhuntly Road, Caulfield South Victoria Australia 3162

Call Us Or Visit Our Web Site For Your Nearest Display Centre.

Phone: 1300 369 395

Fax: 03 9571 1347

Web: www.BellevueImports.com.au

eMail: Info@BellevueImports.com.au

CBV4/08