

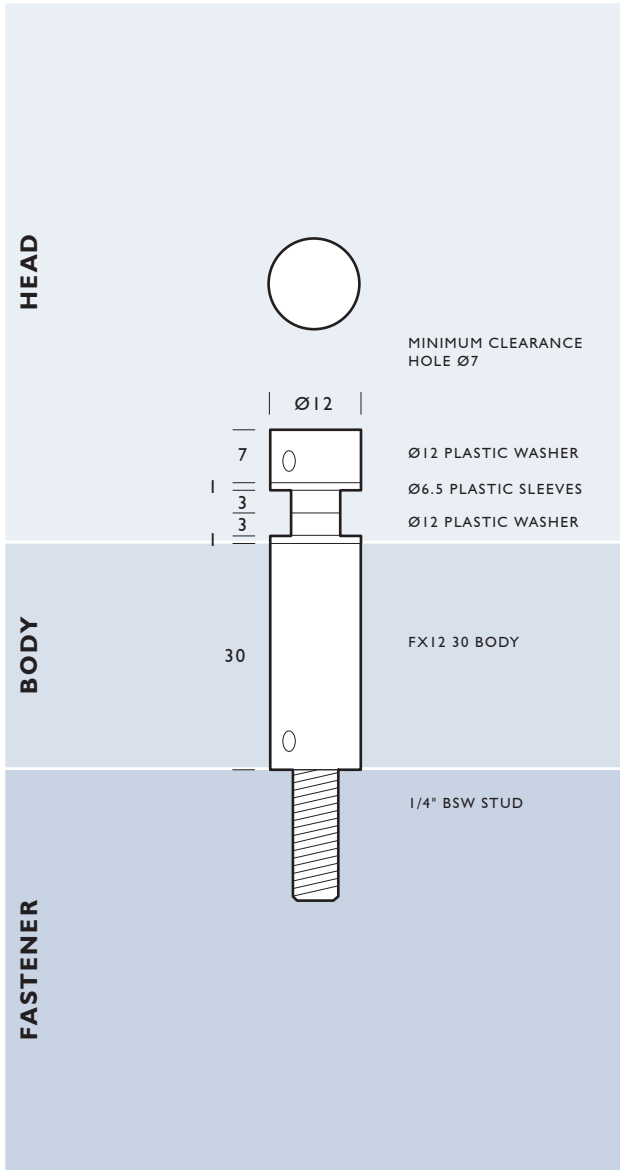

# 12mm DIAMETER PIN

# FX12 PIN



## HEADS:

FX12 HEAD



## FX12 HEAD PACK:



## BODIES:

FX12 20 BODY

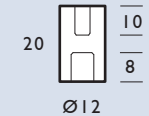

FX12 30 BODY

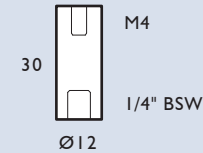

FX12 BW BODY WASHER

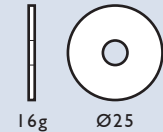

OPTIONAL LOAD SPREADING BODY WASHER

## FX TOOL:

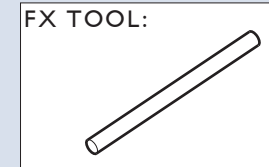

## FASTENERS: FASTENERS COME WITH COMPATIBLE 1/4" BSW STUD

FXNW NUT & WASHER

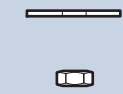

FXST SPRING TOGGLE

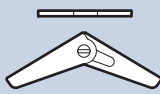

FXTI THREADED INSERT



FXLB LAG BOLT

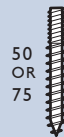

FXFP FACE PLATE

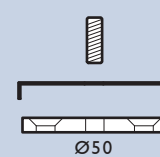

FXMA MASONRY ANCHOR



FXCA CAVITY ANCHOR



## LOCATION:

Interior and exterior (non-marine) applications

## PANEL THICKNESS:

Head Pack 4 - 6mm  
Optional studs available - 8, 10, 12, 16, 20mm

## MINIMUM CLEARANCE HOLE:

With isolating sleeves Ø7  
Without isolating sleeves Ø4.5

## THREAD:

Head - M4 x 4mm  
Fastener - 1/4" B.S.W x 8mm

## FINISH:

Satin Stainless Steel

## MATERIAL:

303 Grade Stainless Steel

## PRODUCT COMPLIANCY:

As FIX Systems are not certified engineers, it is the buyer's responsibility to ensure that the application of all FIX products is suitable for its intended use and that it is compliant with relevant safety standards.



19mm DIAMETER PIN

# FX19 PIN

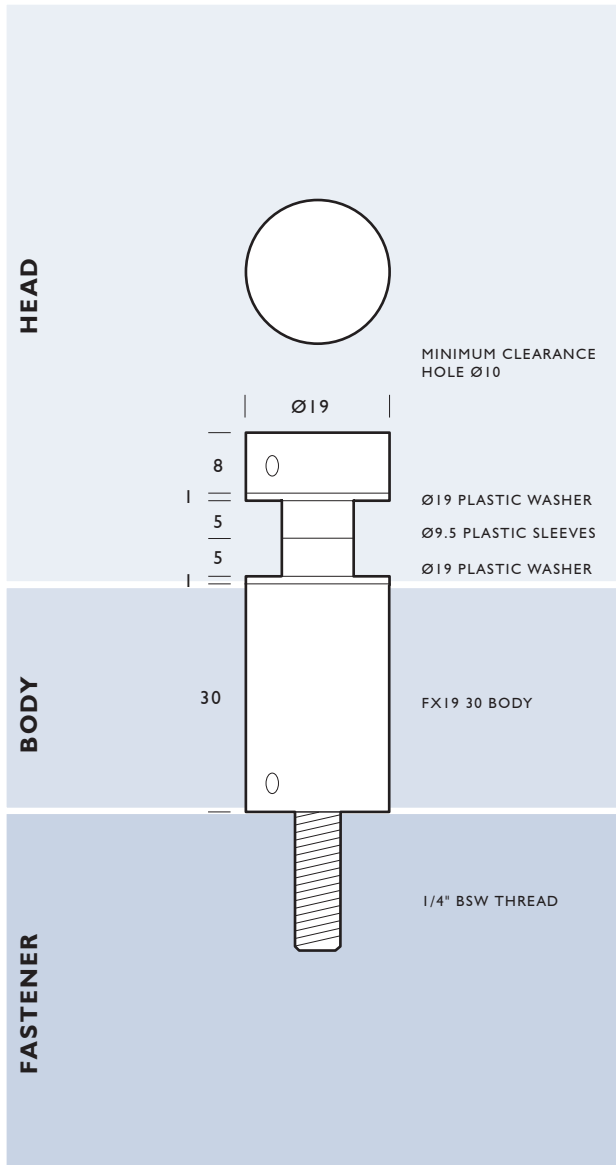

**HEADS:**

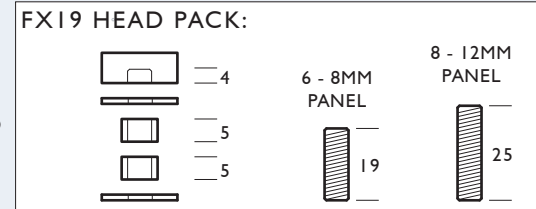
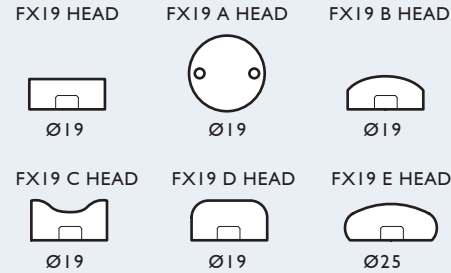

**BODIES:**

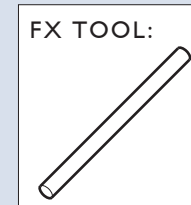
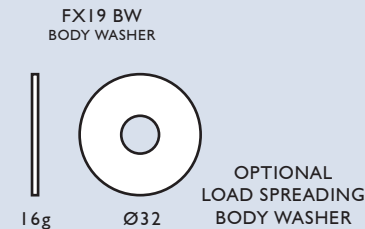
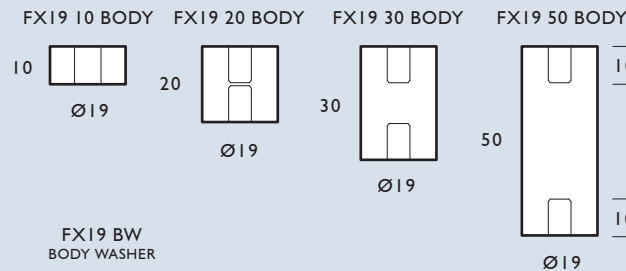

**FASTENERS:** FASTENERS COME WITH COMPATIBLE 1/4" BSW STUD

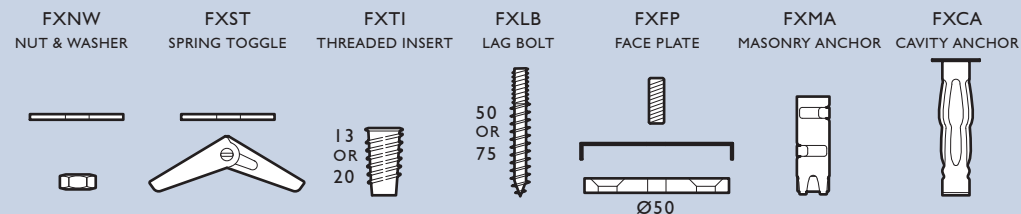

**LOCATION:**

Interior and exterior (non-marine) applications

**PANEL THICKNESS:**

Head Pack 6 - 12mm  
Optional studs available - 19, 22, 25, 27, 29, 32, 38, 51, 75, 100mm

**MINIMUM CLEARANCE HOLE:**

With isolating sleeve Ø10  
Without isolating sleeve Ø7

**THREAD:**

Head - 1/4" B.S.W x 4mm  
Fastener - 1/4" B.S.W x 8mm

**FINISH:**

Satin stainless steel

**MATERIAL:**

303 grade stainless steel

**PRODUCT COMPLIANCY:**

As FIX Systems are not certified engineers, it is the buyer's responsibility to ensure that the application of all FIX products is suitable for its intended use and that it is compliant with relevant safety standards.



# 19mm DIAMETER PANEL SCREW FIXING

# FX 19 PSF

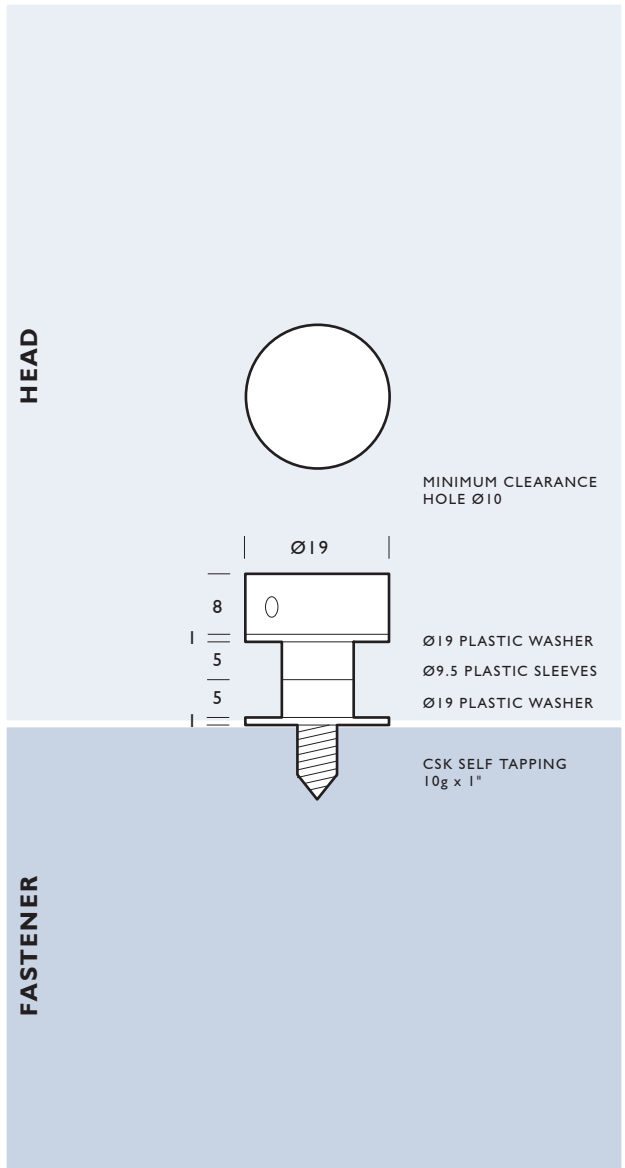

### HEADS:

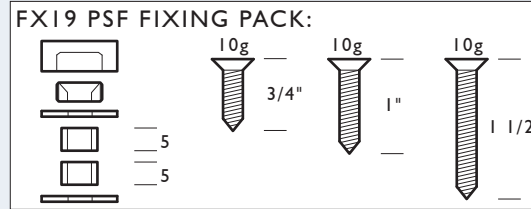
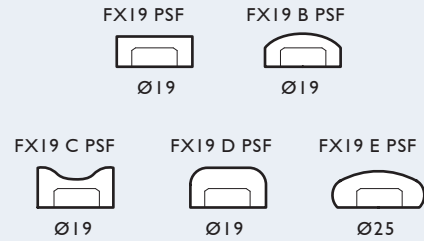

### BODIES:

FX19 10 BODY

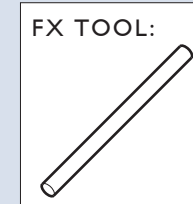
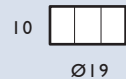

### FASTENERS: □ PLEASE NOMINATE REQUIRED SCREW LENGTH

- 1/4" B.S.W COUNTERSUNK MACHINE SCREWS
- 10g COUNTERSUNK SELF DRILLING SCREWS
- 10g COUNTERSUNK SELF TAPPING SCREWS

\*VARIOUS LENGTHS AVAILABLE

### LOCATIONS:

Interior and exterior (non-marine) applications

### PANEL THICKNESS:

Head Pack 6 - 12mm glass or 1 - 12mm other sheet materials.  
Can be used with any 10g countersunk self tapping, self drilling or machine screw.

### MINIMUM CLEARANCE HOLE:

With isolating sleeve Ø9.5  
Without isolating sleeve Ø7

### SCREW:

10g countersunk screw

### FINISH:

Satin Stainless Steel

### MATERIAL:

303 Grade Stainless Steel

### PRODUCT COMPLIANCY:

As FIX Systems are not certified engineers, it is the buyer's responsibility to ensure that the application of all FIX products is suitable for its intended use and that it is compliant with relevant safety standards.



19mm DIAMETER BACK TO BACK FIXING

# FX 19 BTB

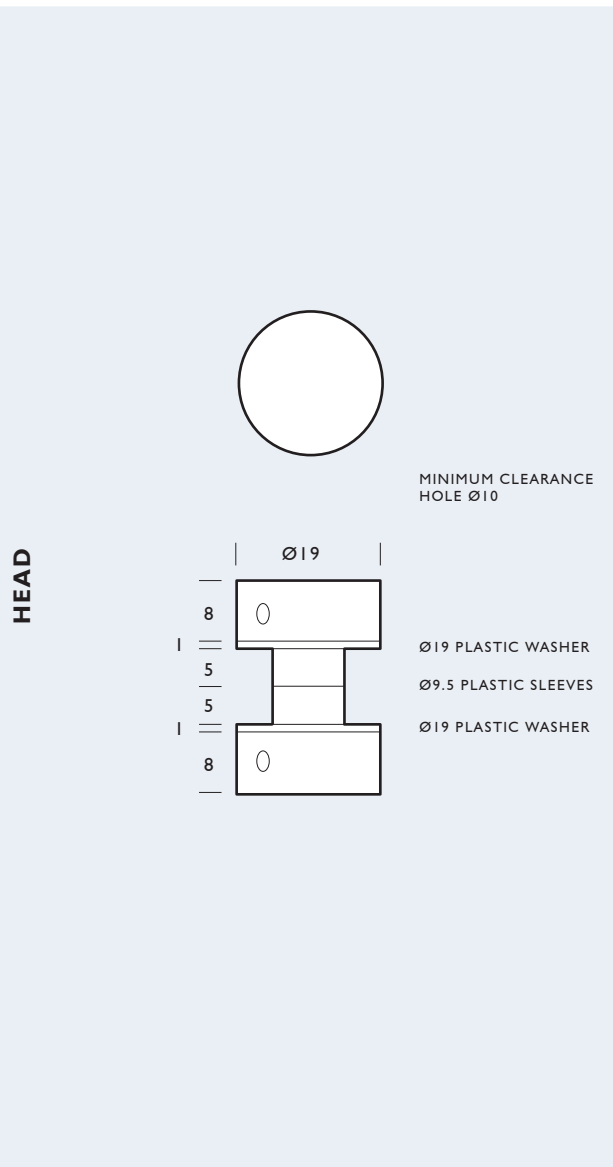

**HEADS:**

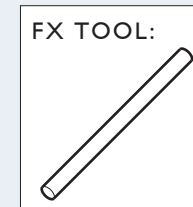
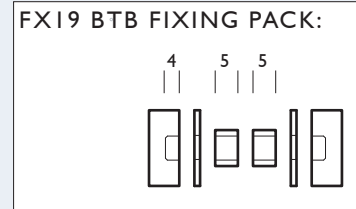

**FASTENERS:** □ PLEASE NOMINATE REQUIRED STUD LENGTH

1/4" WHITWORTH THREADED STUDS:

LENGTHS AS LISTED

- LENGTH 12MM LENGTH 16MM - LENGTH 19MM
- LENGTH 22MM LENGTH 25MM LENGTH 27MM
- LENGTH 29MM LENGTH 32MM LENGTH 38MM
- LENGTH 51MM LENGTH 75MM LENGTH 100MM

**LOCATIONS:**

Interior and exterior (non-marine) applications

**STUD OPTIONS:**

Optional studs available - 19, 22, 25, 27, 29, 32, 38, 51, 75, 100mm.

**MINIMUM CLEARANCE HOLE:**

With isolating sleeve Ø9.5  
Without isolating sleeve Ø7

**THREAD:**

Head - 1/4" B.S.W x 4mm

**FINISH:**

Satin Stainless Steel

**MATERIAL:**

303 Grade Stainless Steel

**PRODUCT COMPLIANCY:**

As FIX Systems are not certified engineers, it is the buyer's responsibility to ensure that the application of all FIX products is suitable for its intended use and that it is compliant with relevant safety standards.



## 25mm DIAMETER PIN

# FX25 PIN

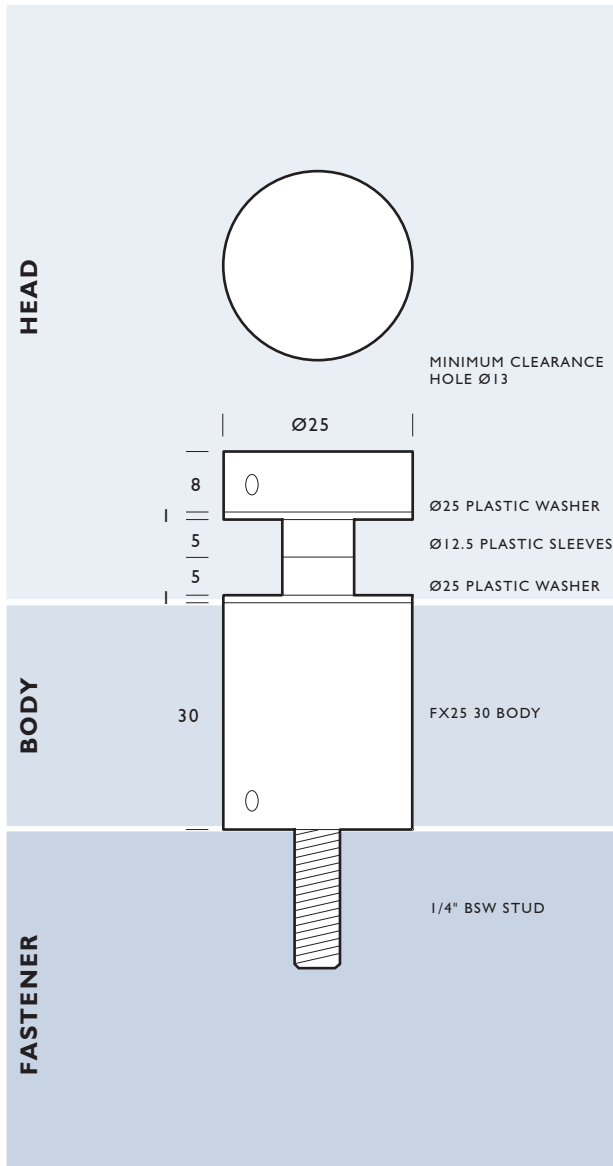

### HEADS:

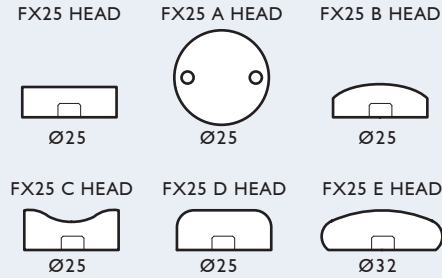

### FX25 HEAD PACK:

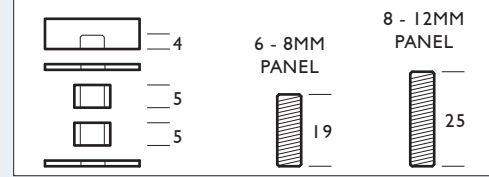

### BODIES:

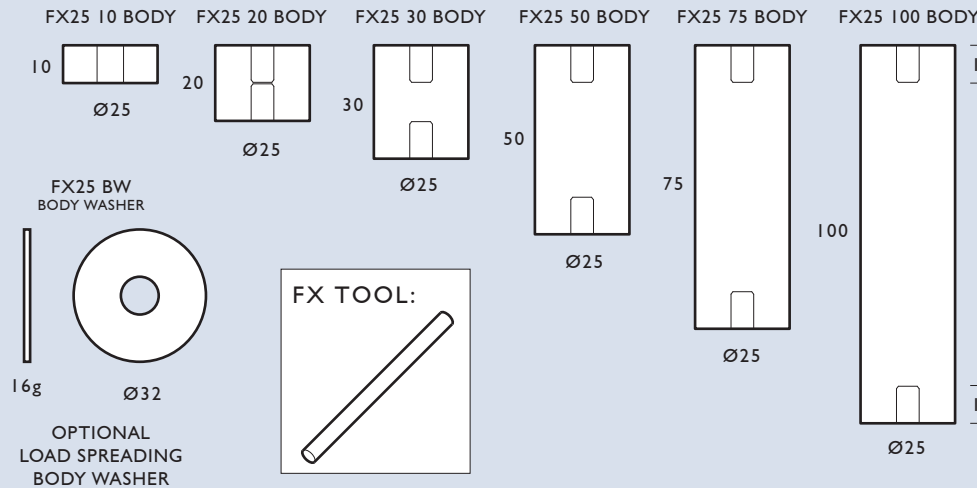

### FASTENERS: FASTENERS COME WITH COMPATIBLE 1/4" BSW STUD

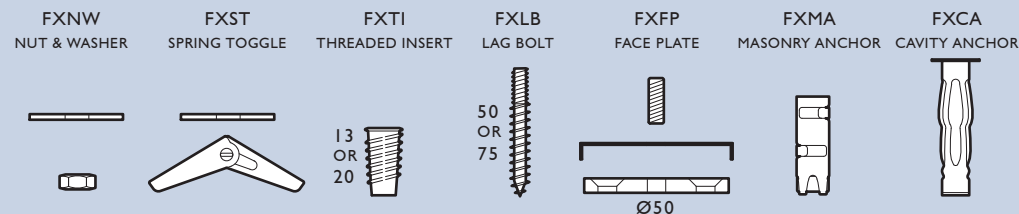

### LOCATIONS:

Interior and exterior (non-marine) applications

### PANEL THICKNESS:

Head Pack 6 - 12mm  
Optional studs available - 19, 22, 25, 27, 29, 32, 38, 51, 75, 100mm

### MINIMUM CLEARANCE HOLE:

With isolating sleeve Ø13  
Without isolating sleeve Ø7

### THREAD:

Head - 1/4" B.S.W x 4mm  
Fastener - 1/4" B.S.W x 8mm

### FINISH:

Satin Stainless Steel

### MATERIAL:

303 Grade Stainless Steel

### PRODUCT COMPLIANCY:

As FIX Systems are not certified engineers, it is the buyer's responsibility to ensure that the application of all FIX products is suitable for its intended use and that it is compliant with relevant safety standards.



## 25mm DIAMETER PANEL SCREW FIXING

# FX25 PSF

HEAD

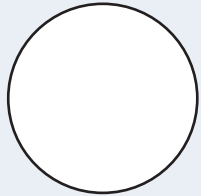

MINIMUM CLEARANCE HOLE Ø13

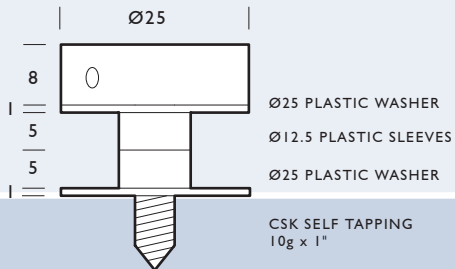

FASTENER

### HEADS:

FX25 PSF



FX25 A PSF

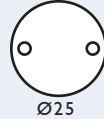

FX25 B PSF



FX25 C PSF

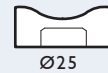

FX25 D PSF

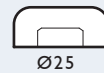

FX25 E PSF

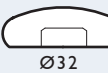

### FX25 PSF FIXING PACK:

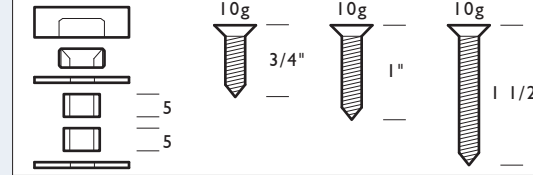

### BODIES:

FX25 10 BODY

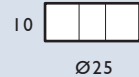

### FX TOOL:

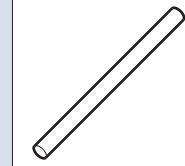

### FASTENERS: □ PLEASE NOMINATE REQUIRED SCREW LENGTH

- 1/4" B.S.W COUNTERSUNK MACHINE SCREWS
- 10g SELF DRILLING SCREWS
- 10g SELF TAPPING SCREWS

\*VARIOUS LENGTHS AVAILABLE

### LOCATIONS:

Interior and exterior (non-marine) applications

### PANEL THICKNESS:

Head Pack 6 - 12mm glass or 1 - 12mm other sheet materials.  
Can be used with any 10g countersunk self tapping, self drilling or machine screw.

### MINIMUM CLEARANCE HOLE:

With isolating sleeve Ø 13  
Without isolating sleeve Ø7

### SCREW:

10g countersunk screw

### FINISH:

Satin Stainless Steel

### MATERIAL:

303 Grade Stainless Steel

### PRODUCT COMPLIANCY:

As FIX Systems are not certified engineers, it is the buyer's responsibility to ensure that the application of all FIX products is suitable for its intended use and that it is compliant with relevant safety standards.



## 25mm DIAMETER BACK TO BACK FIXING

# FX25 BTB

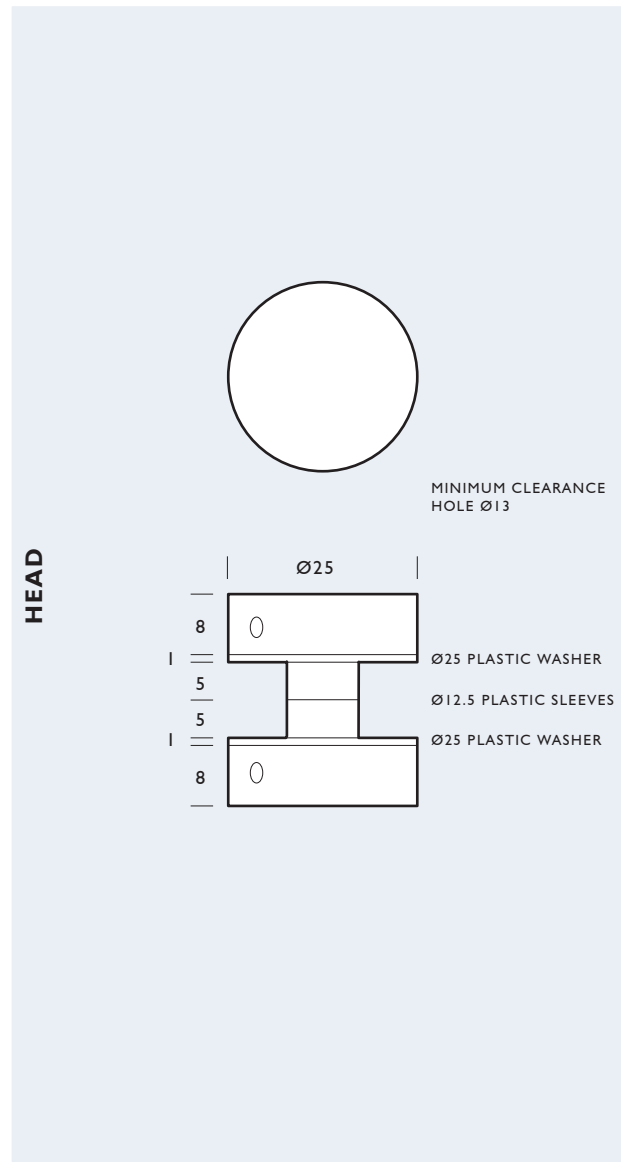

### HEADS:

FX25 HEAD



FX25 A HEAD

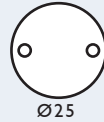

FX25 B HEAD



FX25 C HEAD

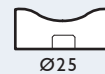

FX25 D HEAD



FX25 E HEAD



### FX25 BTB FIXING PACK:

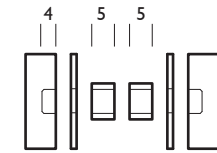

### FX TOOL:

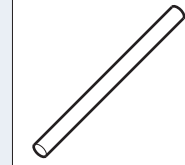

### FASTENERS: □ PLEASE NOMINATE REQUIRED STUD LENGTH

1/4" WHITWORTH THREADED STUDS:

LENGTHS AS LISTED

- LENGTH 12MM LENGTH 16MM - LENGTH 19MM
- LENGTH 22MM LENGTH 25MM LENGTH 27MM
- LENGTH 29MM LENGTH 32MM LENGTH 38MM
- LENGTH 51MM LENGTH 75MM LENGTH 100MM

### LOCATIONS:

Interior and exterior (non-marine) applications

### STUD OPTIONS:

Optional studs available - 19, 22, 25, 27, 29, 32, 38, 51, 75, 100mm

### MINIMUM CLEARANCE HOLE:

With isolating sleeve Ø13  
Without isolating sleeve Ø7

### THREAD:

Head - 1/4" B.S.W x 4mm

### FINISH:

Satin Stainless Steel

### MATERIAL:

303 Grade Stainless Steel

### PRODUCT COMPLIANCY:

As FIX Systems are not certified engineers, it is the buyer's responsibility to ensure that the application of all FIX products is suitable for its intended use and that it is compliant with relevant safety standards.





25mm DIAMETER COUNTERSUNK PIN

# FX25 CSP

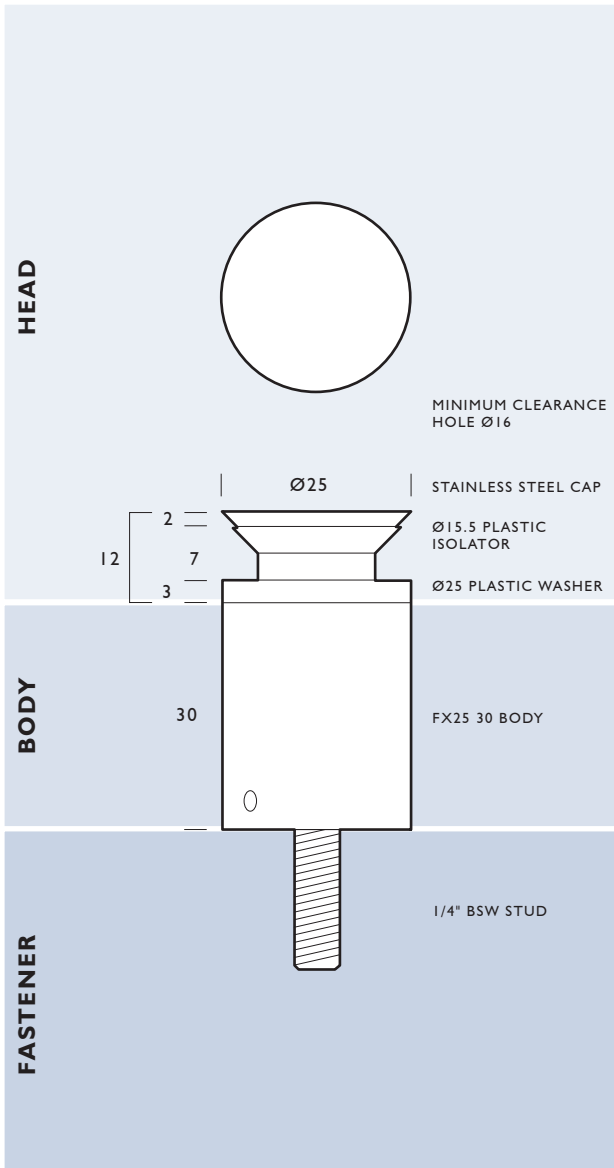

**HEADS:**

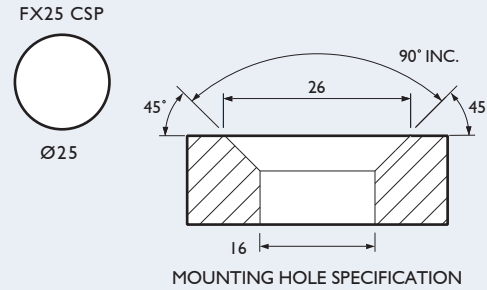

**FX25 CSP HEAD PACK:**

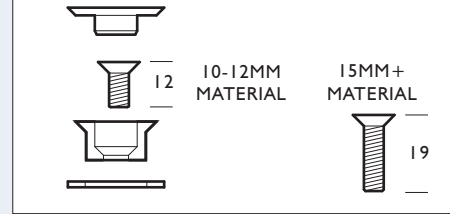

**LOCATIONS:**

Interior and exterior (non-marine) applications

**PANEL THICKNESS:**

Head Pack 10 - 15mm  
Optional 1/4" B.S.W countersunk machine screws available - 12, 19, 25, 32, 38, 44, 50 and 75mm

**MINIMUM CLEARANCE HOLE:**

The clearance hole is 16mm, which is then countersunk to 26mm. (refer diagram)

**THREAD:**

1/4" B.S.W countersunk machine screw  
Fastener - 1/4" B.S.W

**FINISH:**

Satin Stainless Steel

**MATERIAL:**

303 Grade Stainless Steel

**PRODUCT COMPLIANCY:**

As FIX Systems are not certified engineers, it is the buyer's responsibility to ensure that the application of all FIX products is suitable for its intended use and that it is compliant with relevant safety standards.

**BODIES:**

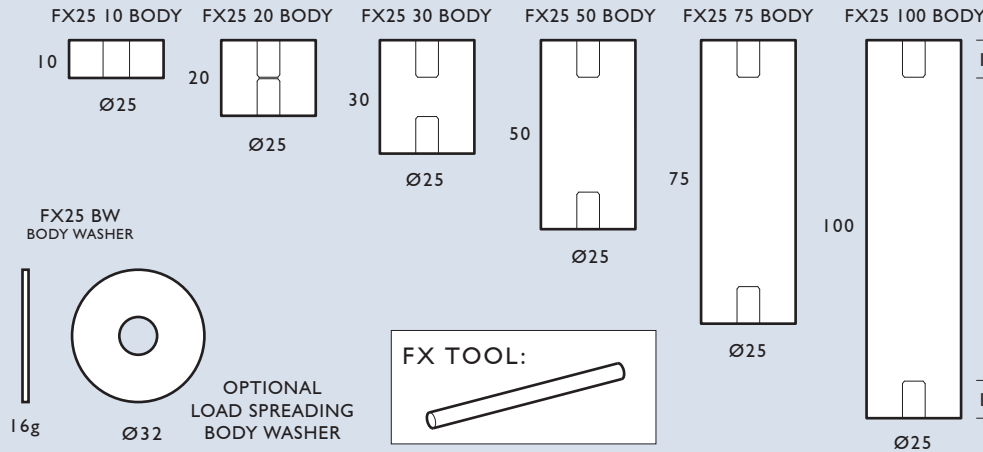

**FASTENERS:** FASTENERS COME WITH COMPATIBLE 1/4" BSW STUD

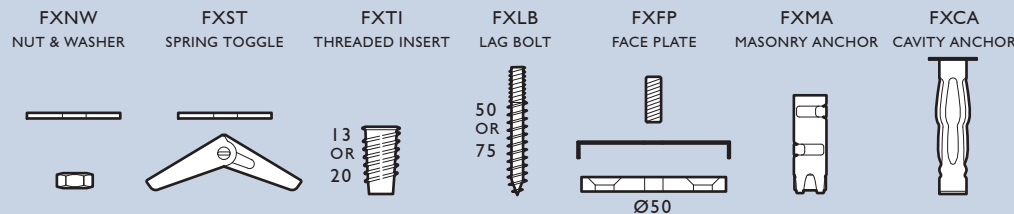

## 25mm DIAMETER COUNTERSUNK SCREW FIXING

# FX25 CSF

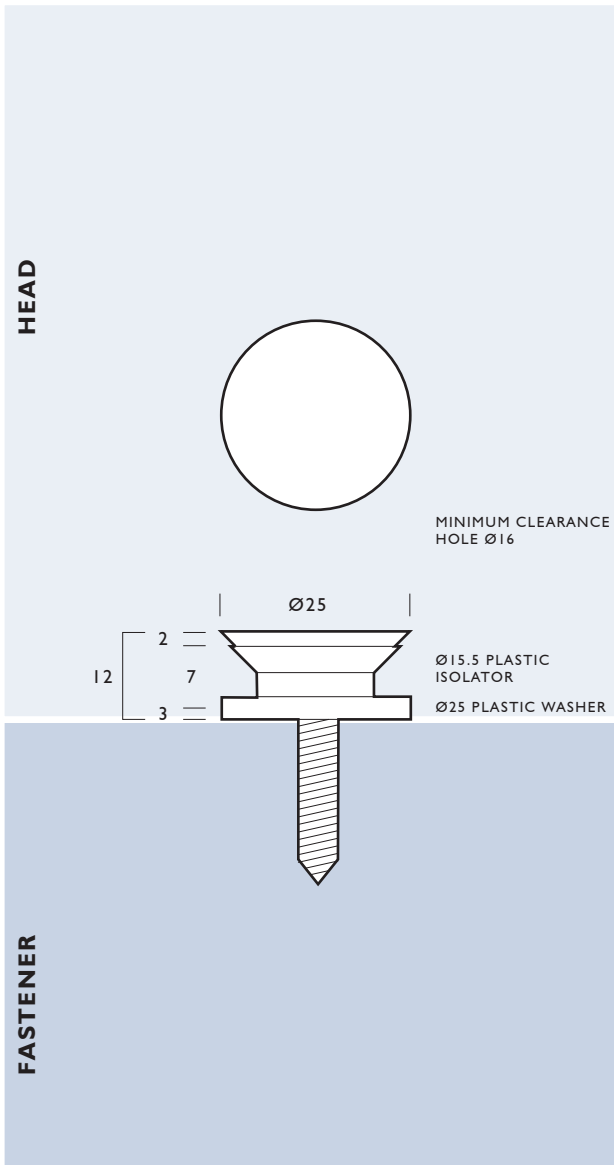

### HEADS:

FX25 CSF

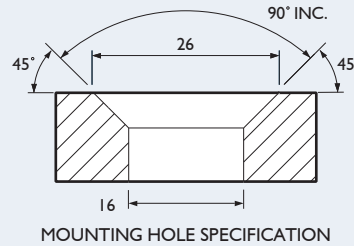
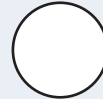

### FX25 CSF FIXING PACK:

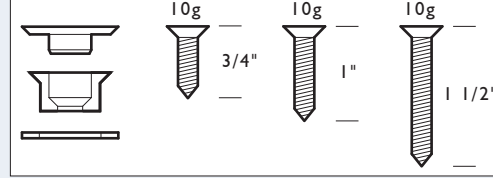

### BODIES:

FX25 10 BODY

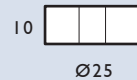

### FASTENERS: □ PLEASE NOMINATE REQUIRED SCREW LENGTH

- 1/4" B.S.W COUNTERSUNK MACHINE SCREWS
- 10g SELF DRILLING SCREWS
- 10g SELF TAPPING SCREWS

\*VARIOUS LENGTHS AVAILABLE

### LOCATIONS:

Interior and exterior (non-marine) applications

### PANEL THICKNESS:

Head Pack 10 - 12mm  
Can be used with any 10g countersunk self tapping, self drilling or machine screw

### MINIMUM CLEARANCE HOLE:

The clearance hole is 16mm, which is then countersunk to 26mm (refer diagram).

### SCREW:

10g countersunk screw

### FINISH:

Satin Stainless Steel

### MATERIAL:

303 Grade Stainless Steel

### PRODUCT COMPLIANCY:

As FIX Systems are not certified engineers, it is the buyer's responsibility to ensure that the application of all FIX products is suitable for its intended use and that it is compliant with relevant safety standards.



32mm DIAMETER COUNTERSUNK PIN

# FX32 CSP

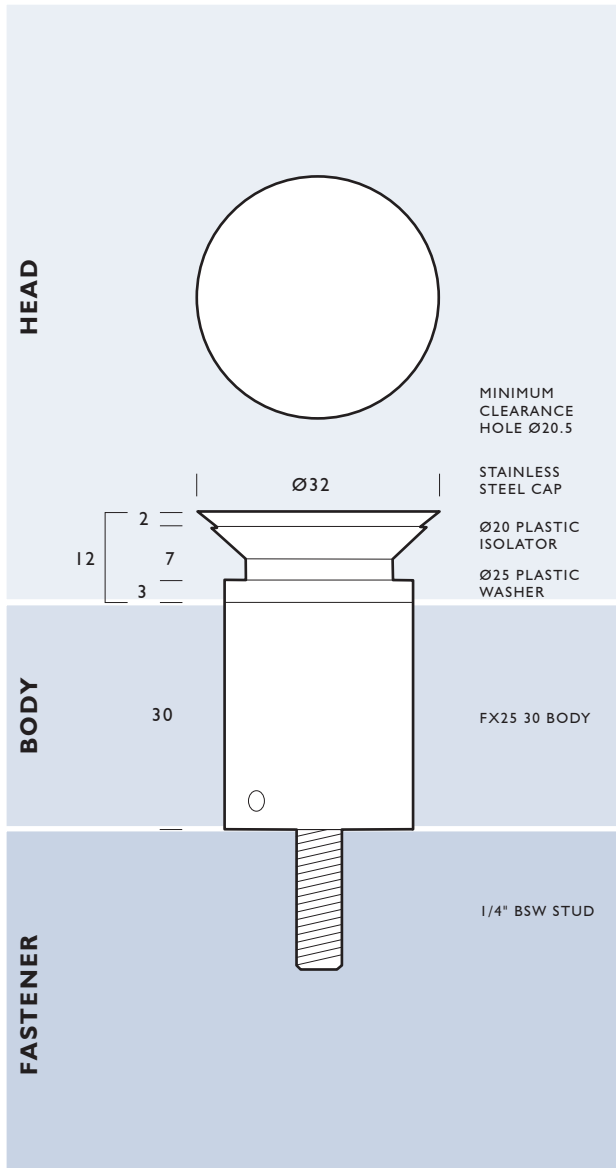

**HEADS:**

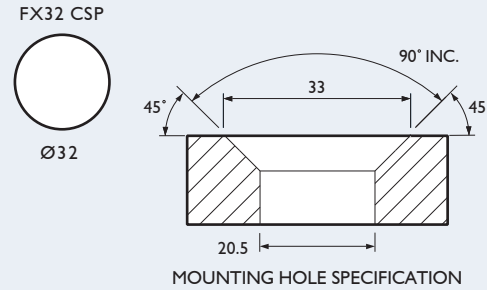

**FX32 CSP HEAD PACK:**

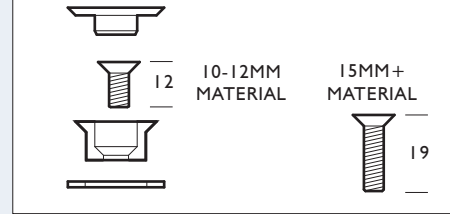

**BODIES:**

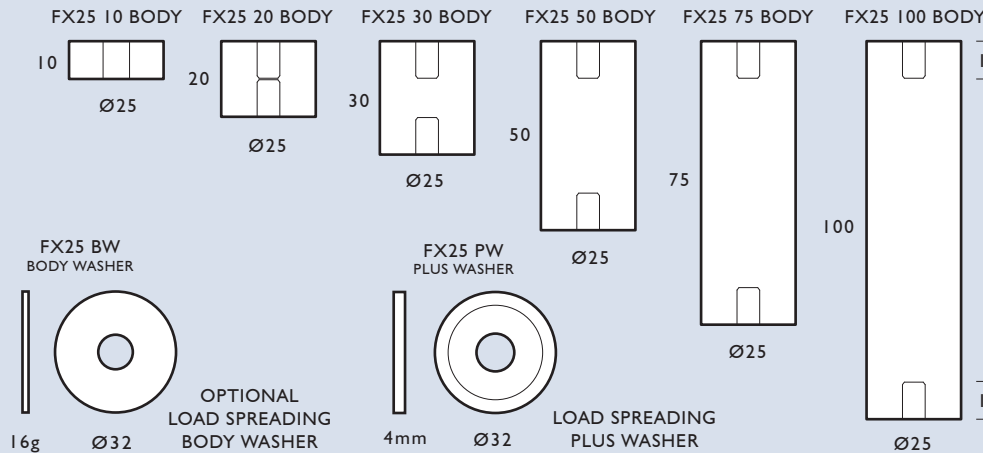

**FASTENERS:** FASTENERS COME WITH COMPATIBLE 1/4" BSW STUD

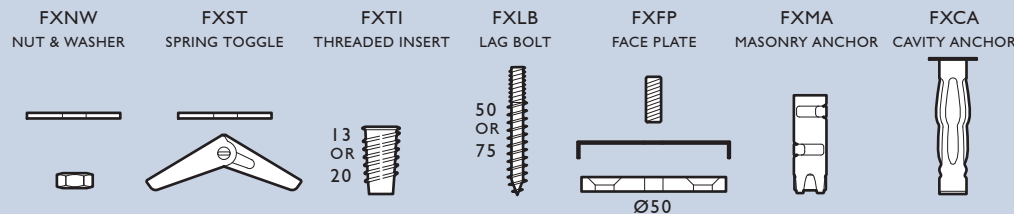

**LOCATIONS:**

Interior and exterior (non-marine) applications

**PANEL THICKNESS:**

Head Pack 10 - 15mm  
Optional 1/4" B.S.W countersunk machine screws available - 12, 19, 25, 32, 38, 44, 50 and 75mm

**MINIMUM CLEARANCE HOLE:**

The clearance hole is 20.5mm, which is then countersunk to 33mm (refer diagram).

**THREAD:**

1/4" B.S.W countersunk machine screw  
Fastener - 1/4" B.S.W

**FINISH:**

Satin Stainless Steel

**MATERIAL:**

303 Grade Stainless Steel

**PRODUCT COMPLIANCY:**

As FIX Systems are not certified engineers, it is the buyer's responsibility to ensure that the application of all FIX products is suitable for its intended use and that it is compliant with relevant safety standards.



25mm DIAMETER COUNTERSUNK PIN

# FX25 DUO CSK

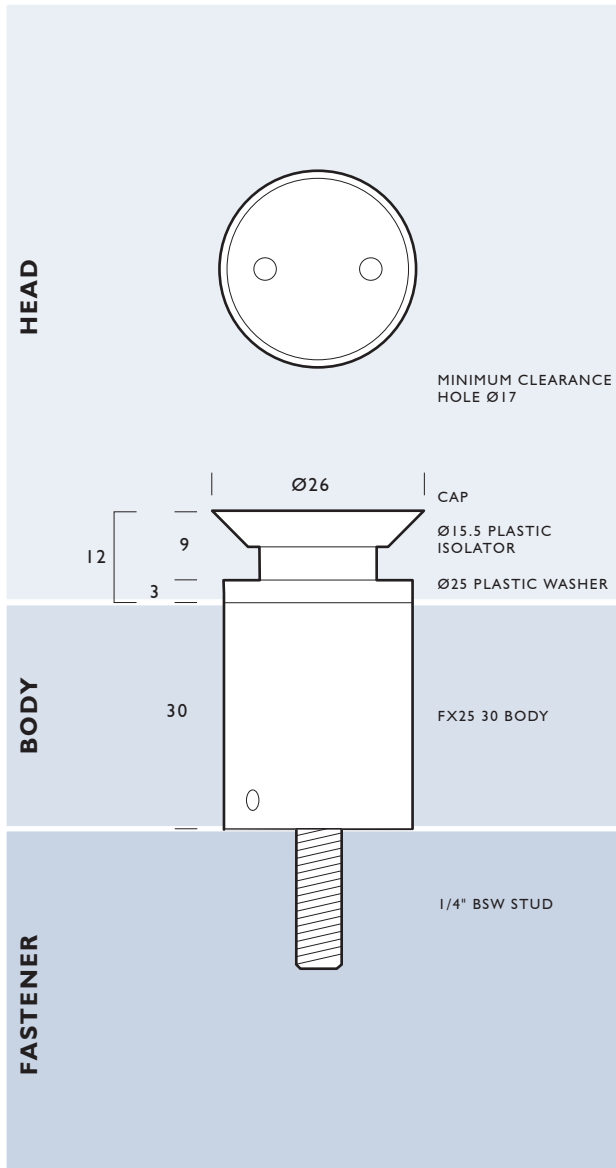

**HEADS:**

FX25 DUO CSK

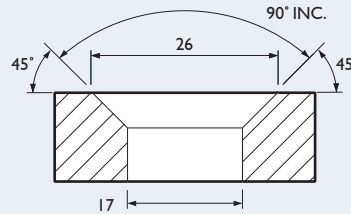

MOUNTING HOLE SPECIFICATION

**FX25 DUO CSK HEAD PACK:**

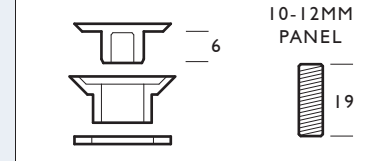

**LOCATIONS:**

Interior and exterior (non-marine) applications

**PANEL THICKNESS:**

Head Pack 10mm - 12mm  
Optional studs available - 19, 22, 25, 27, 29, 32, 38, 51, 75, 100mm

**MINIMUM CLEARANCE HOLE:**

The clearance hole is 17mm, which is then countersunk to 26mm (refer diagram).

**THREAD:**

Head - 1/4" B.S.W x 6mm  
Fastener - 1/4" B.S.W x 10mm

**FINISH:**

Satin Stainless Steel

**MATERIAL:**

303 Grade Stainless Steel

**PRODUCT COMPLIANCY:**

As FIX Systems are not certified engineers, it is the buyer's responsibility to ensure that the application of all FIX products is suitable for its intended use and that it is compliant with relevant safety standards.

**BODIES:**

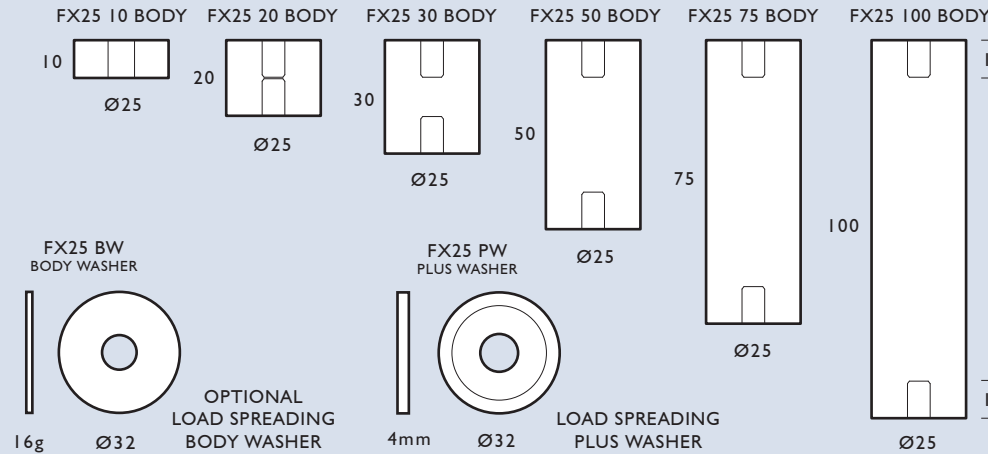

**FASTENERS:** FASTENERS COME WITH COMPATIBLE 1/4" BSW STUD

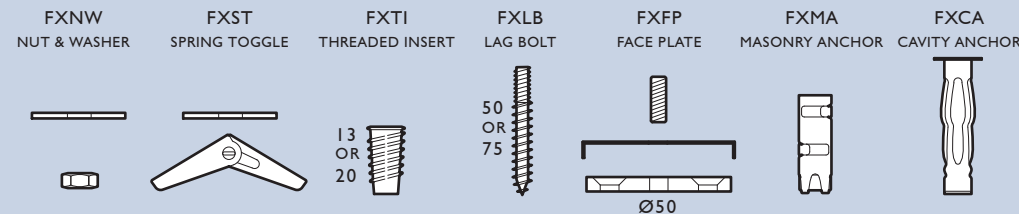

## 25mm DIAMETER COUNTERSUNK BACK FIXING

# FX25 CSA

HEAD

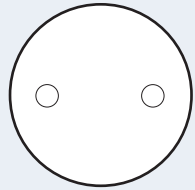

MINIMUM CLEARANCE HOLE Ø10

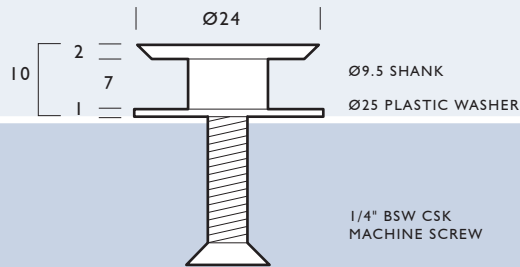

FASTENER

### HEADS:

FX25 CSA

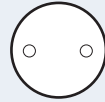

Ø25

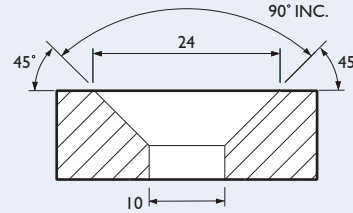

MOUNTING HOLE SPECIFICATION

### FX25 CSA FIXING PACK:

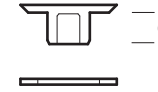

### BODIES:

FX25 10 BODY



Ø25

### FASTENERS: □ PLEASE NOMINATE REQUIRED SCREW LENGTH

- 1/4" B.S.W CSK MACHINE SCREWS

\*VARIOUS LENGTHS AVAILABLE

### LOCATIONS:

Interior and exterior (non-marine) applications

### PANEL THICKNESS:

Head Pack 10mm > (non-glass)  
Optional screws available - any 1/4" B.S.W machine screw

### MINIMUM CLEARANCE HOLE:

The clearance hole is 10mm, which is then countersunk to 24mm (refer diagram).

### THREAD:

Head - 1/4" B.S.W

### FINISH:

Satin Stainless Steel

### MATERIAL:

303 Grade Stainless Steel

### PRODUCT COMPLIANCY:

As FIX Systems are not certified engineers, it is the buyer's responsibility to ensure that the application of all FIX products is suitable for its intended use and that it is compliant with relevant safety standards.



## 25mm DIAMETER COUNTERSUNK BACK FIXING

# FX25 CSG

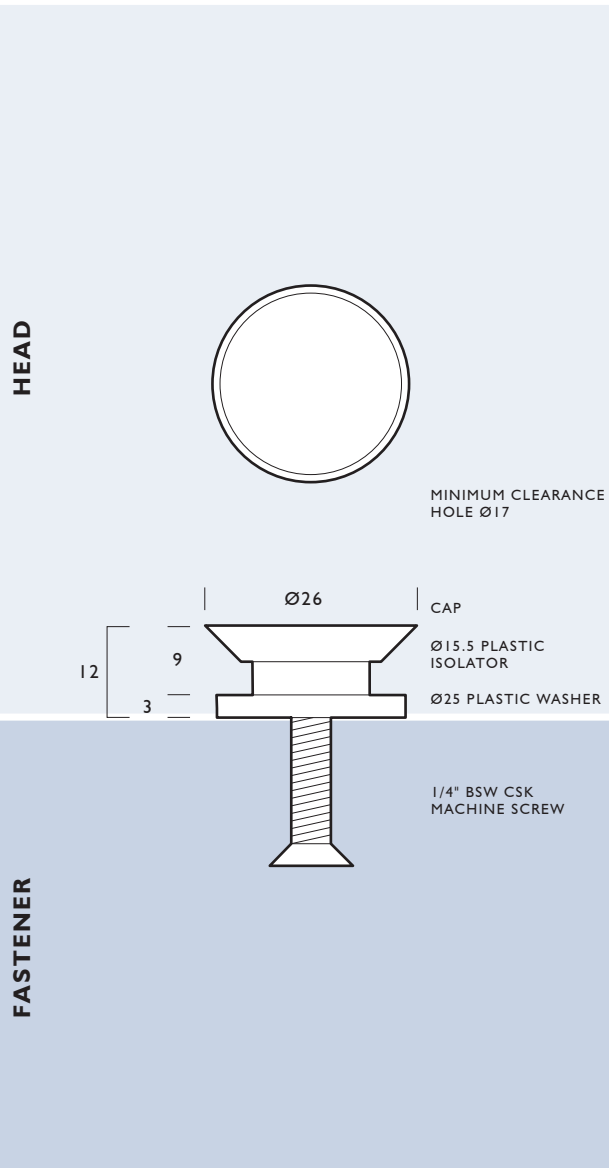

### HEADS:

FX25 CSG

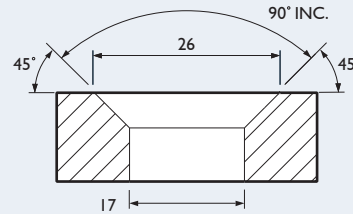
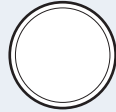

### FX25 CSG FIXING PACK:

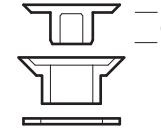

### BODIES:

FX25 10 BODY



### FASTENERS: □ PLEASE NOMINATE REQUIRED SCREW LENGTH

- 1/4" B.S.W CSK MACHINE SCREWS

\*VARIOUS LENGTHS AVAILABLE

### LOCATIONS:

Interior and exterior (non-marine) applications

### PANEL THICKNESS:

Head Pack 10mm - 12mm glass  
Optional screws available - any  
1/4" B.S.W machine screw

### MINIMUM CLEARANCE HOLE:

The clearance hole is 17mm, which is then countersunk to 26mm (refer diagram).

### THREAD:

Head - 1/4" B.S.W

### FINISH:

Satin Stainless Steel

### MATERIAL:

303 Grade Stainless Steel

### PRODUCT COMPLIANCY:

As FIX Systems are not certified engineers, it is the buyer's responsibility to ensure that the application of all FIX products is suitable for its intended use and that it is compliant with relevant safety standards.



## 25mm DIAMETER COUNTERSUNK BACK FIXING

# FX25 CSB

HEAD

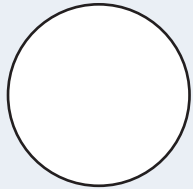

### HEADS:

FX25 CSB

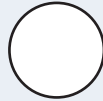

Ø25

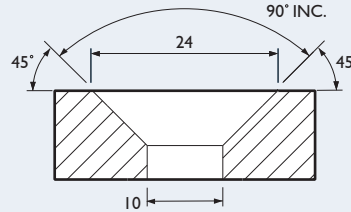

MOUNTING HOLE SPECIFICATION

### FX25 CSB FIXING PACK:

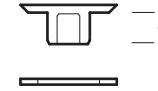

### LOCATIONS:

Interior and exterior (non-marine) applications

### PANEL THICKNESS:

Head Pack 10mm > (non-glass)  
Optional screws available - any 1/4" B.S.W machine screw

### MINIMUM CLEARANCE HOLE:

The clearance hole is 10mm, which is then countersunk to 24mm (refer diagram).

### THREAD:

Head - 1/4" B.S.W x 6mm

### FINISH:

Satin Stainless Steel

### MATERIAL:

303 Grade Stainless Steel

### PRODUCT COMPLIANCY:

As FIX Systems are not certified engineers, it is the buyer's responsibility to ensure that the application of all FIX products is suitable for its intended use and that it is compliant with relevant safety standards.

FASTENER

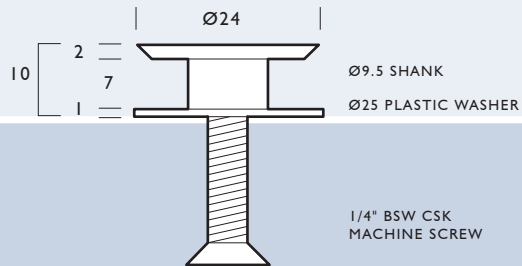

MINIMUM CLEARANCE HOLE Ø10

Ø24  
Ø9.5 SHANK  
Ø25 PLASTIC WASHER

1/4" BSW CSK MACHINE SCREW

### BODIES:

FX25 10 BODY



Ø25

### FASTENERS: □ PLEASE NOMINATE REQUIRED SCREW LENGTH

- 1/4" B.S.W CSK MACHINE SCREWS

\*VARIOUS LENGTHS AVAILABLE



## 25mm DIAMETER LOW PROFILE PIN

# FX25 TRI

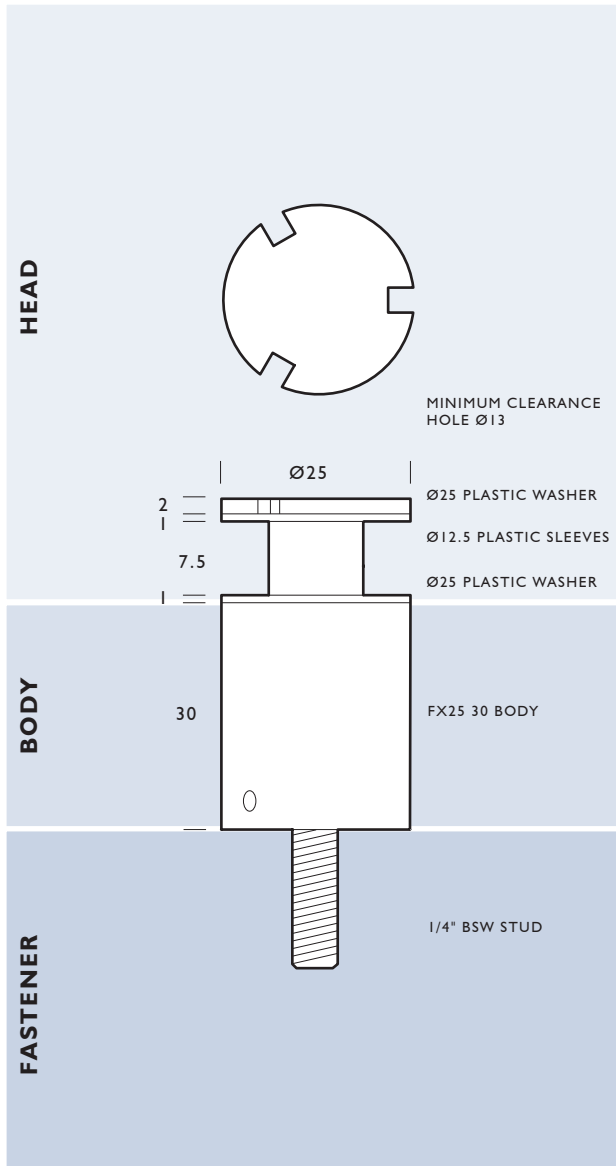

### HEADS:



### FX25 TRI HEAD PACK:

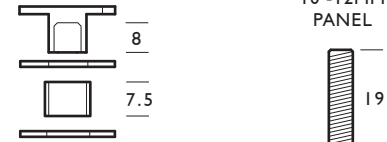

### BODIES:

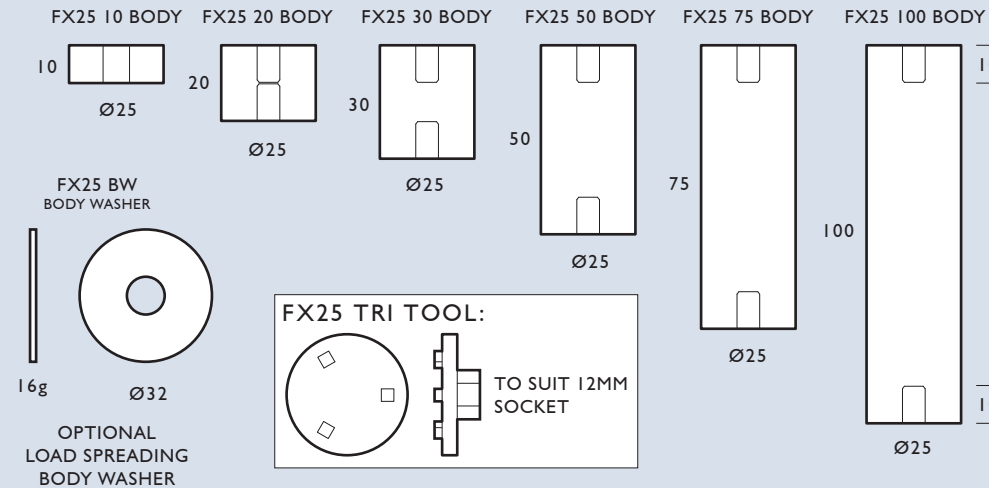

### FASTENERS: □ FASTENERS COME WITH COMPATIBLE 1/4" BSW STUD

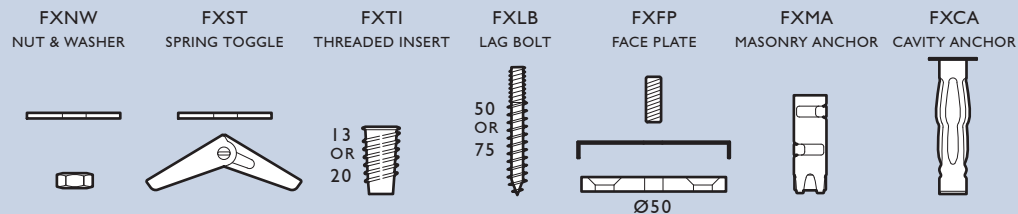

### LOCATIONS:

Interior and exterior (non-marine) applications

### PANEL THICKNESS:

Head pack 10 - 12mm  
Optional studs available - 19, 22, 25, 27, 29, 32, 38, 51, 75, 100mm

### MINIMUM CLEARANCE HOLE:

With isolating sleeve Ø13  
Without isolating sleeve Ø10

### THREAD:

Head - 1/4" B.S.W x 8mm  
Fastener - 1/4" B.S.W x 10mm

### FINISH:

Satin Stainless Steel

### MATERIAL:

303 Grade Stainless Steel

### PRODUCT COMPLIANCY:

As FIX Systems are not certified engineers; it is the buyer's responsibility to ensure that the application of all FIX products is suitable for its intended use and that it is compliant with relevant safety standards.





25mm DIAMETER LOW PROFILE PIN

# FX25 TRI PLUS

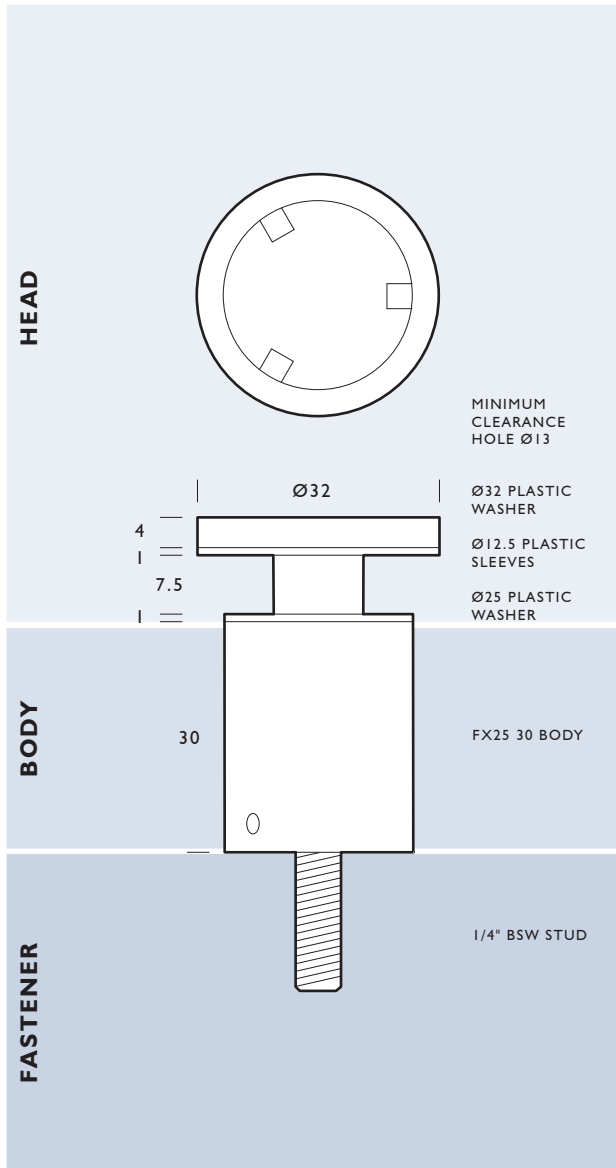

**HEADS:**

FX25 TRI PLUS



**FX25 TRI PLUS HEAD PACK:**

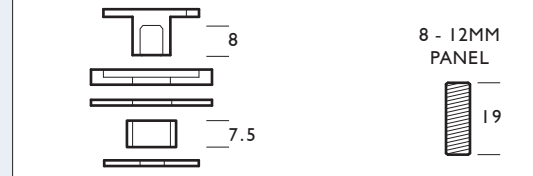

**BODIES:**

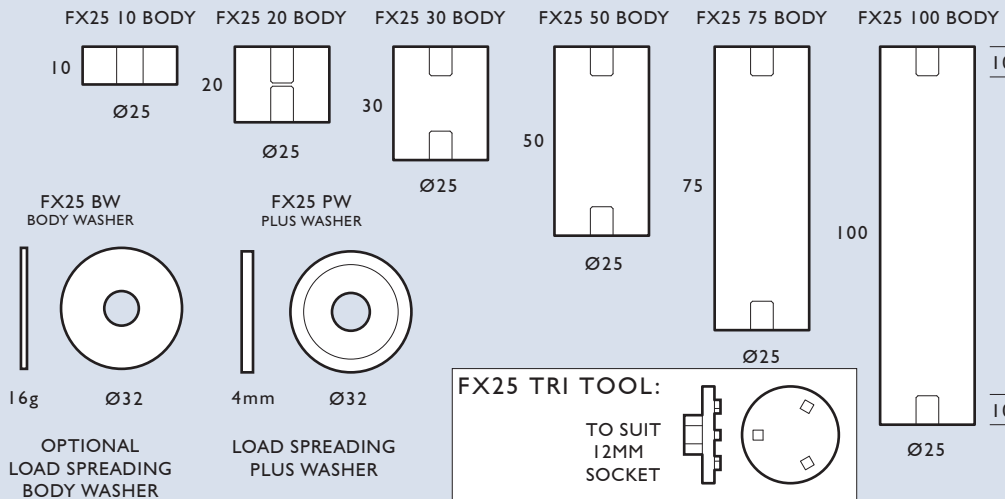

**FASTENERS:** FASTENERS COME WITH COMPATIBLE 1/4" BSW STUD

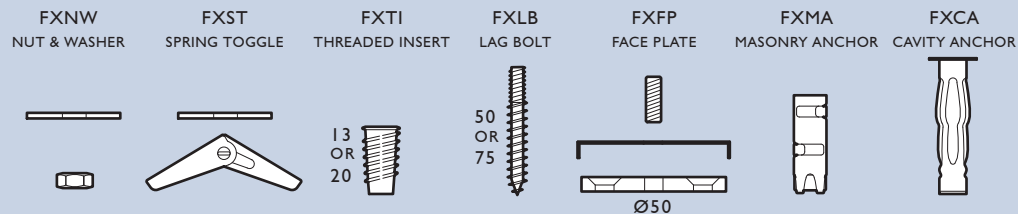

**LOCATIONS:**

Interior and exterior (non-marine) applications

**PANEL THICKNESS:**

Head Pack 8 - 12mm  
Optional studs available - 19, 22, 25, 27, 29, 32, 38, 51, 75, 100mm

**MINIMUM CLEARANCE HOLE:**

With isolating sleeve Ø13  
Without isolating sleeve Ø10

**THREAD:**

Head - 1/4" B.S.W x 8mm  
Fastener - 1/4" B.S.W x 10mm

**FINISH:**

Satin Stainless Steel

**MATERIAL:**

303 Grade Stainless Steel

**PRODUCT COMPLIANCY:**

As FIX Systems are not certified engineers, it is the buyer's responsibility to ensure that the application of all FIX products is suitable for its intended use and that it is compliant with relevant safety standards.



25mm DIAMETER UN-SEEN PIN

# FX25 USP

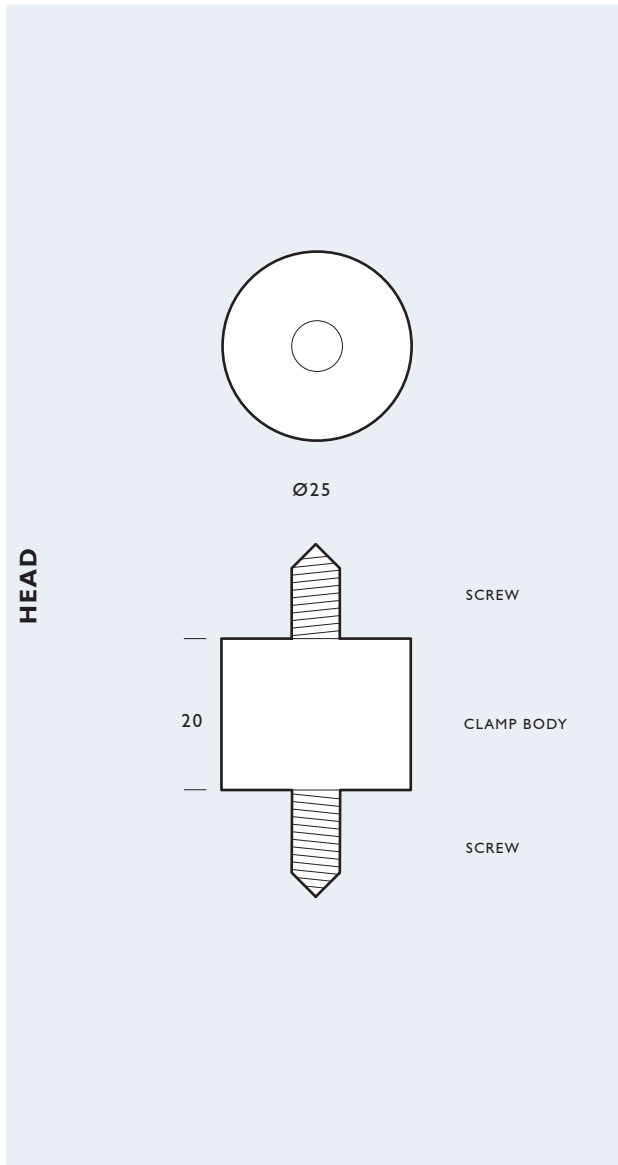

FX25 USP

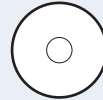

FX25 USP PACK:

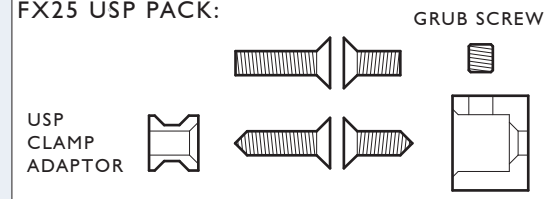

**LOCATIONS:**

Interior and exterior (non-marine) applications

**SCREWS:**

Countersunk 1/4" B.S.W machine thread or 10g countersunk self tapping thread

**FINISH:**

Satin Stainless Steel

**MATERIAL:**

303 Grade Stainless Steel

**PRODUCT COMPLIANCY:**

As FIX Systems are not certified engineers, it is the buyer's responsibility to ensure that the application of all FIX products is suitable for its intended use and that it is compliant with relevant safety standards.

**BODIES:**

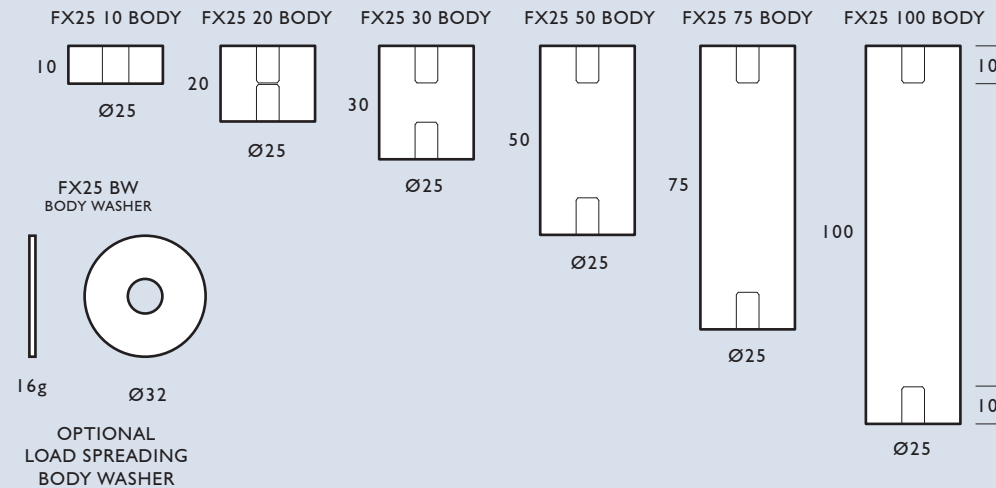

**FASTENERS:** FASTENERS COME WITH COMPATIBLE 1/4" BSW STUD

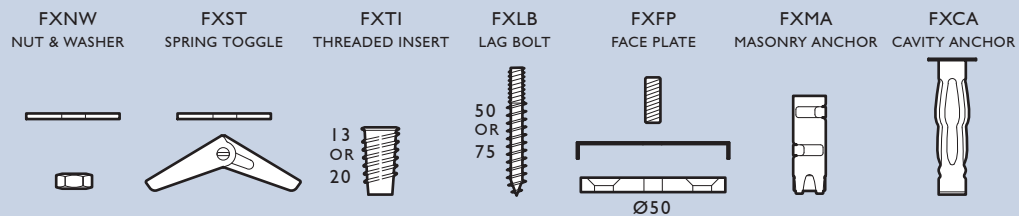

## 25mm DIAMETER WIRE CLAMP ASSEMBLY

# FX25 WCA

### FX25 WCA - SINGLE CLAMP

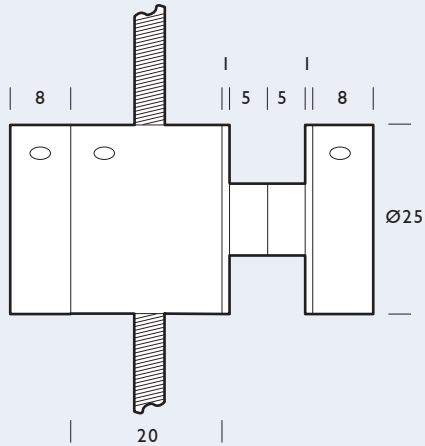

#### FX25 WCA SINGLE CLAMP PACK:

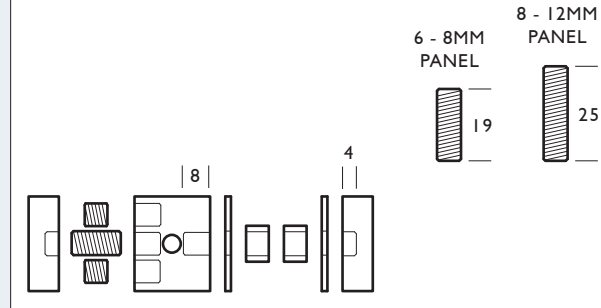

### FX25 WCA - DOUBLE CLAMP

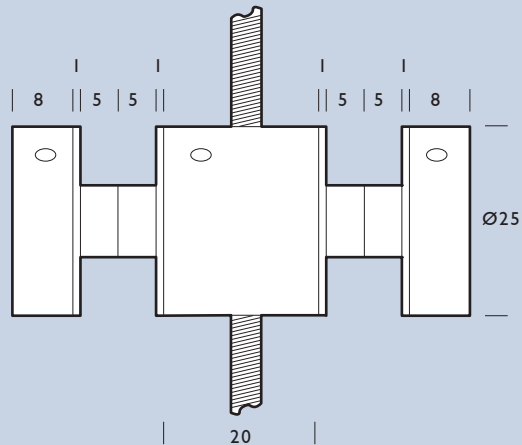

#### FX25 WCA DOUBLE CLAMP PACK:

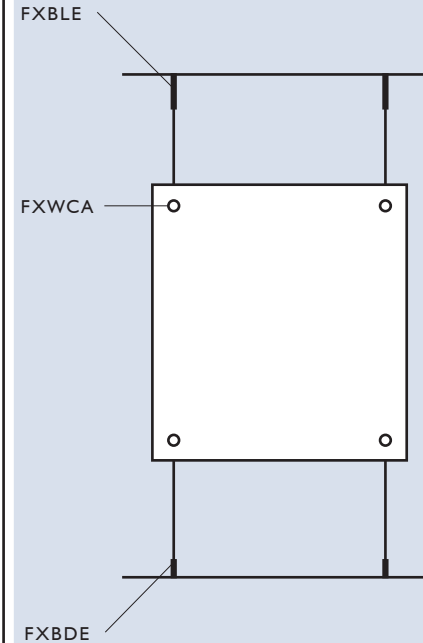
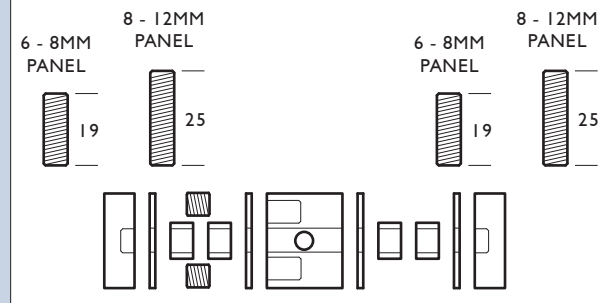

FXBDE

#### FX19/25 TOOL:

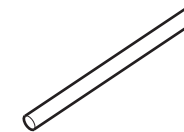

#### LOCATION:

Interior and exterior (non-marine) applications

#### PANEL THICKNESS:

Head Pack 6 - 12mm  
Optional studs available - 19, 22, 25, 27, 29, 32, 38, 51, 75, 100mm

#### MINIMUM CLEARANCE HOLE:

With isolating sleeve  $\varnothing 13$   
Without isolating sleeve  $\varnothing 7$

#### THREAD:

Head -  $\square$  1/4" B.S.W x 4mm  
Body -  $\square$  1/4" B.S.W x 8mm

#### FINISH:

Satin Stainless Steel

#### MATERIAL:

303 Grade Stainless Steel

#### PRODUCT COMPLIANCY:

As FIX Systems are not certified engineers, it is the buyer's responsibility to ensure that the application of all FIX products is suitable for its intended use and that it is compliant with relevant safety standards.

## 32mm DIAMETER STRUCTURAL PIN

# FX32 PIN

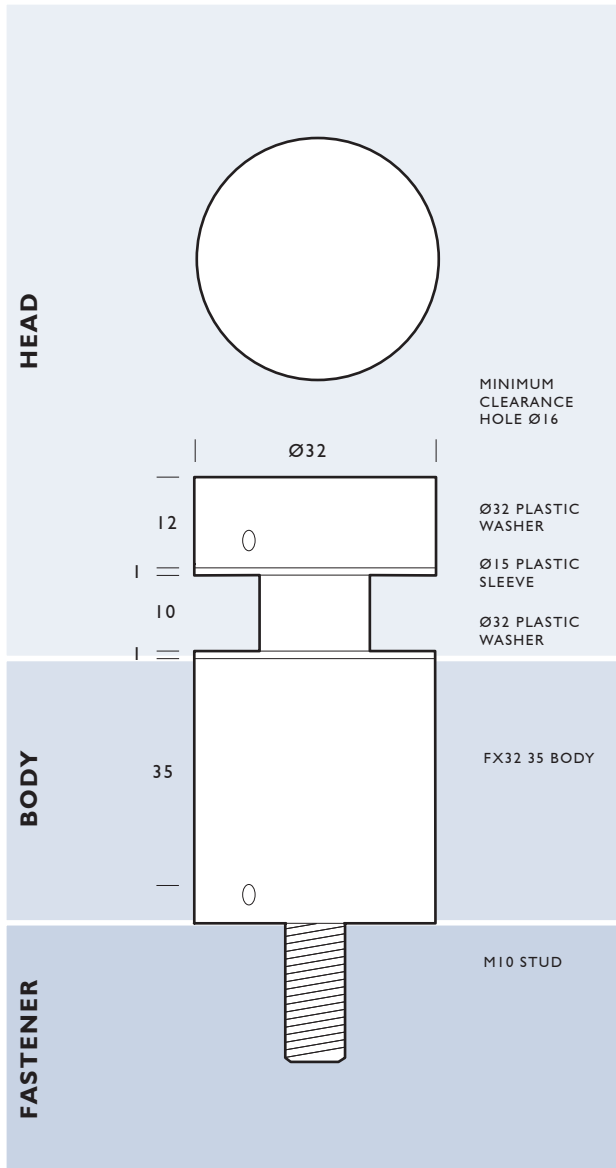

### HEADS:

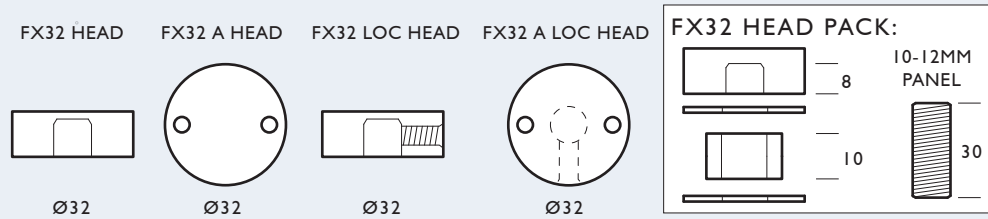

### BODIES:

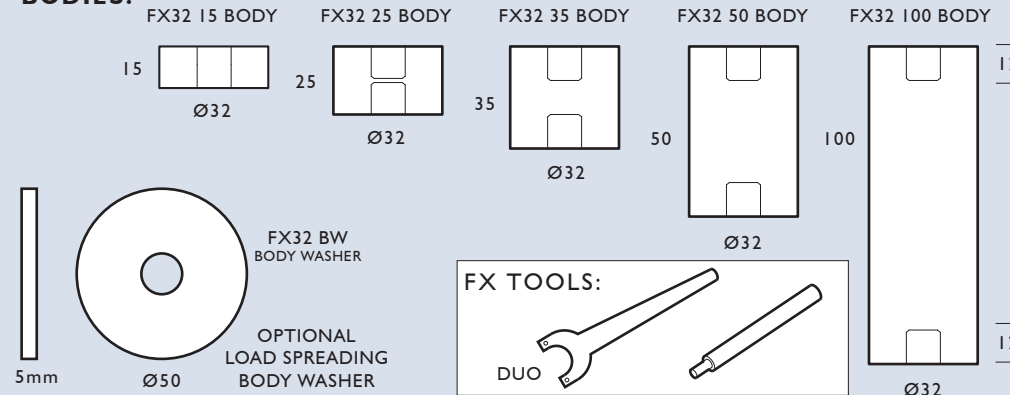

### FASTENERS:

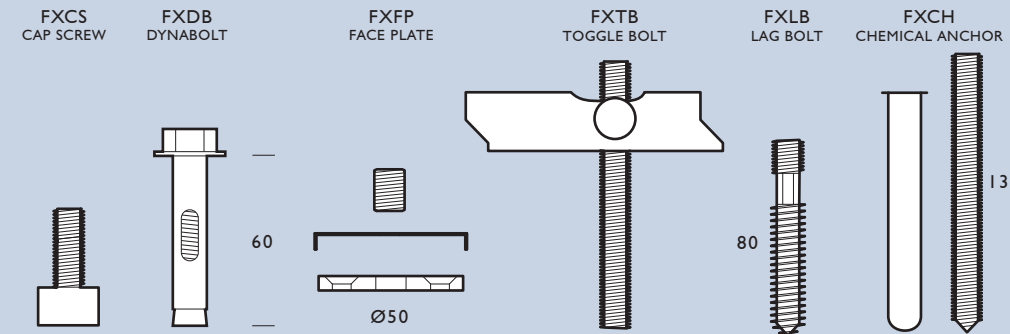

### LOCATIONS:

Interior and exterior applications

### PANEL THICKNESS:

Head Pack 10 - 12mm  
Optional studs available - 16, 20, 25, 30, 35, 40, 50, 100mm

### MINIMUM CLEARANCE HOLE:

With isolating sleeve Ø16  
Without isolating sleeve Ø10.5

### THREAD:

Head - M10 x 8mm  
Fastener - M10 x 12mm

### FINISH:

Satin Stainless Steel

### MATERIAL:

316 Grade Stainless Steel

### PRODUCT COMPLIANCY:

As FIX Systems are not certified engineers, it is the buyer's responsibility to ensure that the application of all FIX products is suitable for its intended use and that it is compliant with relevant safety standards.



## 32mm DIAMETER STRUCTURAL BACK TO BACK FIXING

# FX32 BTB

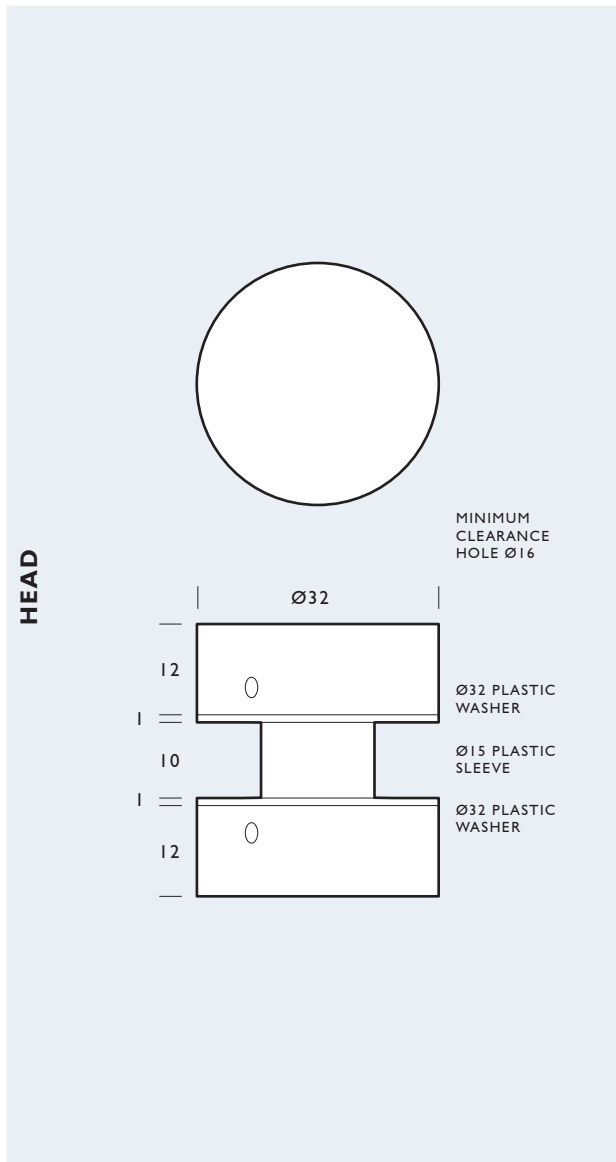

### HEADS:

FX32 HEAD

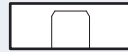

Ø32

FX32 A HEAD

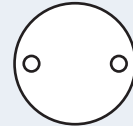

Ø32

FX32 BTB FIXING PACK:

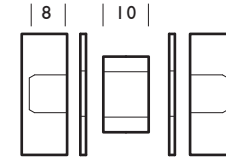

FX32 LOC HEAD



Ø32

FX32 A LOC HEAD



Ø32

FX TOOLS:

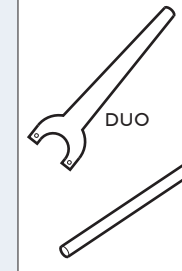

### FASTENERS: □ PLEASE NOMINATE REQUIRED STUD LENGTH

#### M10 THREADED STUDS:

LENGTHS AS LISTED

- LENGTH 16MM
- LENGTH 20MM
- LENGTH 25MM
- LENGTH 30MM
- LENGTH 35MM
- LENGTH 40MM
- LENGTH 50MM
- LENGTH 100MM
- CUSTOM

### LOCATIONS:

Interior and exterior applications

### STUD OPTIONS:

Optional studs available - 16, 20, 25, 30, 35, 40, 50, 100mm, custom

### MINIMUM CLEARANCE HOLE:

With isolating sleeve Ø16  
Without isolating sleeve Ø10.5

### THREAD:

Head - M10 x 8mm

### FINISH:

Satin Stainless Steel

### MATERIAL:

316 Grade Stainless Steel

### PRODUCT COMPLIANCY:

As FIX Systems are not certified engineers, it is the buyer's responsibility to ensure that the application of all FIX products is suitable for its intended use and that it is compliant with relevant safety standards.

32mm DIAMETER STRUCTURAL COUNTERSUNK PIN

# FX32 DUO CSK

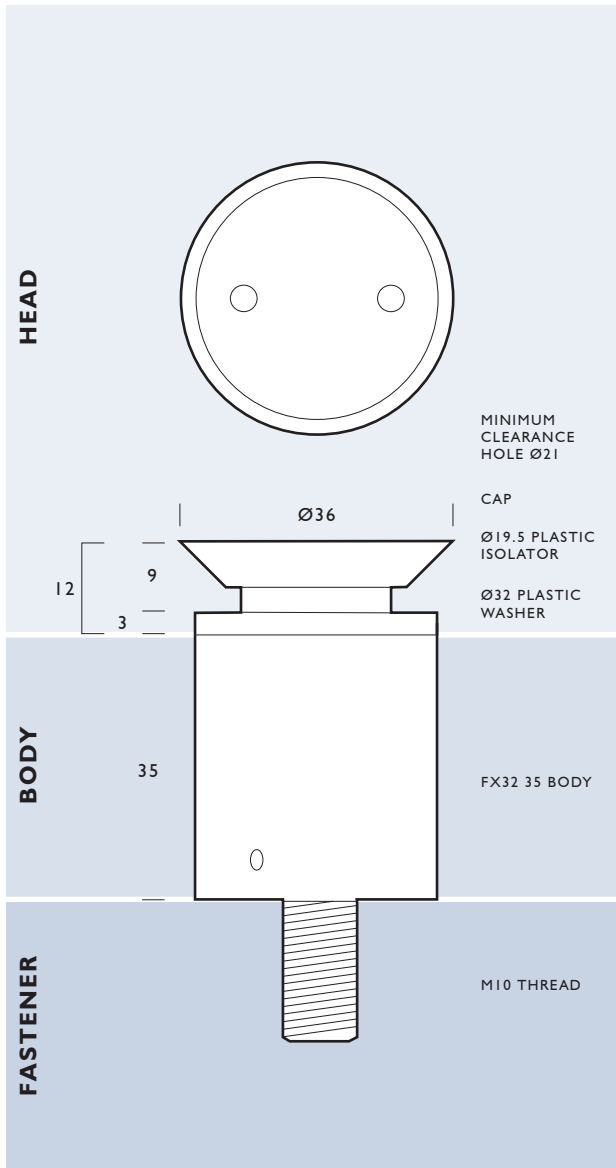

**HEADS:**

FX32 DUO CSK

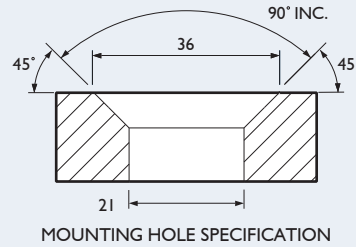
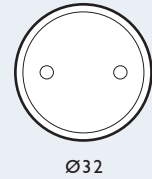

**FX32 DUO CSK HEAD PACK:**

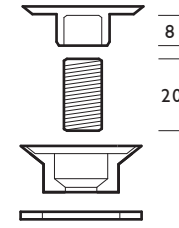

**BODIES:**

Ø32 + Ø50

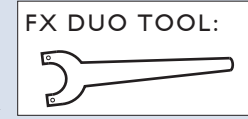
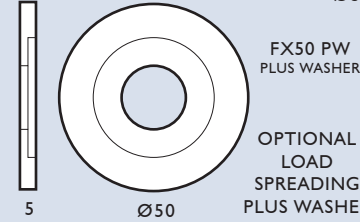
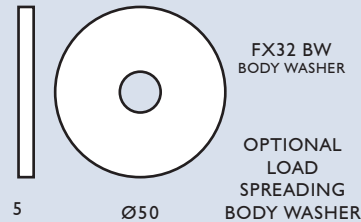
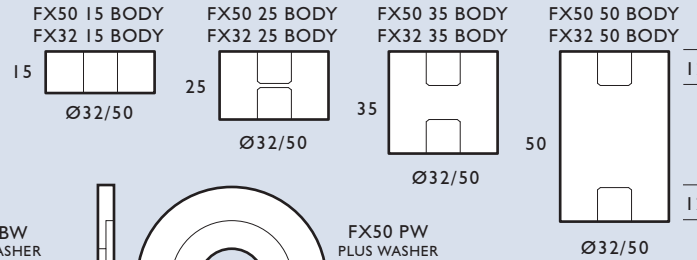

**FASTENERS:**

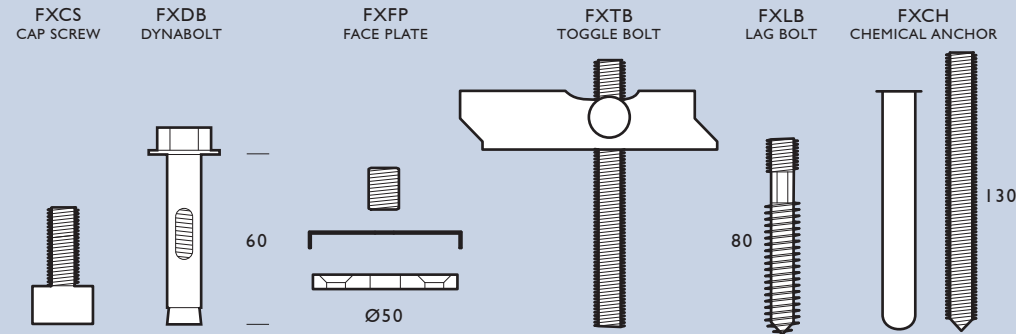

**LOCATIONS:**

Interior and exterior applications

**PANEL THICKNESS:**

Head Pack 10mm -12mm  
Optional studs available - 16, 20, 25, 30, 35, 40, 50mm

**MINIMUM CLEARANCE HOLE:**

The clearance hole is 21mm, which is then countersunk to 36mm (refer diagram).

**THREAD:**

Head - M10 x 8mm  
Fastener - M10 x 12mm

**FINISH:**

Satin Stainless Steel

**MATERIAL:**

316 Grade Stainless Steel

**PRODUCT COMPLIANCY:**

As FIX Systems are not certified engineers, it is the buyer's responsibility to ensure that the application of all FIX products is suitable for its intended use and that it is compliant with relevant safety standards.



# 32mm DIAMETER STRUCTURAL LOW PROFILE PIN

# FX32 TRI

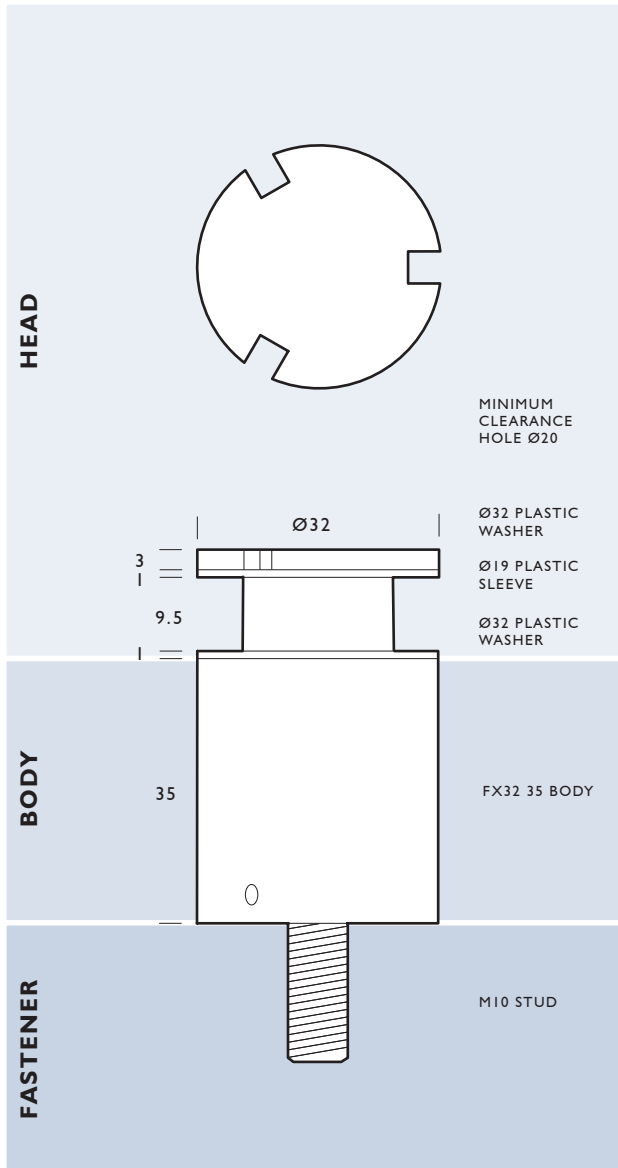

## HEADS:

FX32 TRI

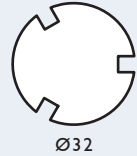

## FX32 TRI HEAD PACK:

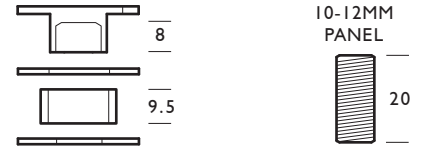

## BODIES:

FX32 15 BODY

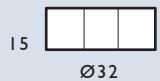

FX32 25 BODY

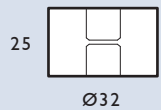

FX32 35 BODY

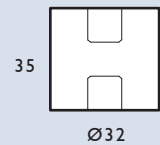

FX32 50 BODY

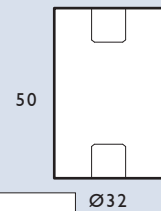

FX32 100 BODY

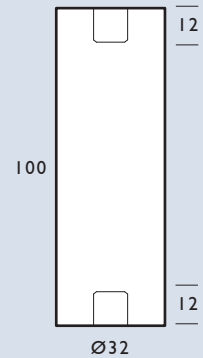

FX32 BW  
BODY WASHER

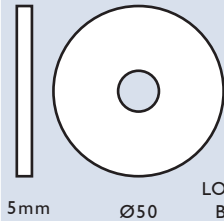

OPTIONAL  
LOAD SPREADING  
BODY WASHER

## FX32TRI TOOL:

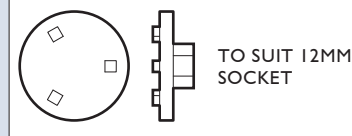

## FASTENERS:

FXCS  
CAP SCREW

FXDB  
DYNABOLT

FXFP  
FACE PLATE

FXTB  
TOGGLE BOLT

FXLB  
LAG BOLT

FXCH  
CHEMICAL ANCHOR

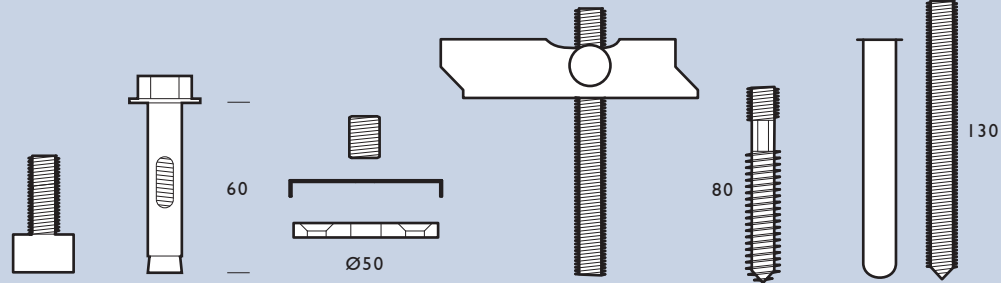

## LOCATIONS:

Interior and exterior applications

## PANEL THICKNESS:

Head Pack 10 - 12mm  
Optional studs available - 16, 20, 25, 30, 35, 40, 50mm, custom

## MINIMUM CLEARANCE HOLE:

With isolating sleeve Ø20  
Without isolating sleeve Ø17

## THREAD:

Head - M10 x 8mm  
Fastener - M10 X 12mm

## FINISH:

Satin Stainless Steel

## MATERIAL:

316 Grade Stainless steel

## PRODUCT COMPLIANCY:

As FIX Systems are not certified engineers, it is the buyer's responsibility to ensure that the application of all FIX products is suitable for its intended use and that it is compliant with relevant safety standards.



50mm DIAMETER STRUCTURAL LOW PROFILE PIN

# FX32 TRI PLUS

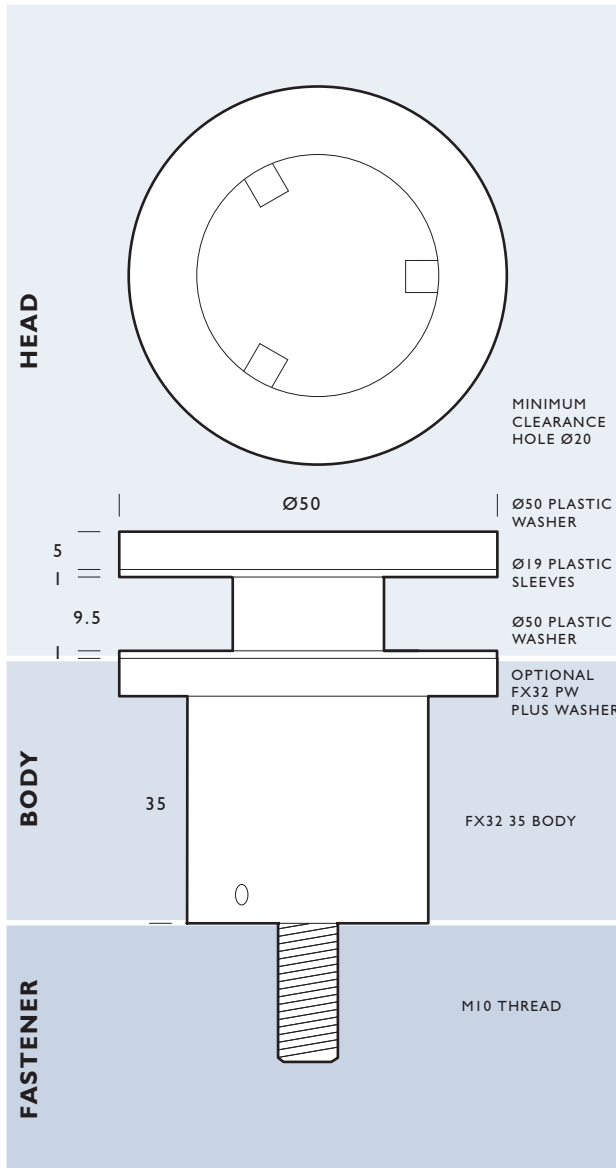

**HEADS:**

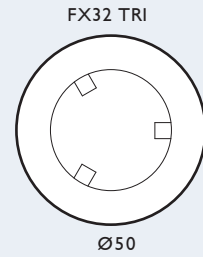

**FX32 TRI PLUS HEAD PACK:**

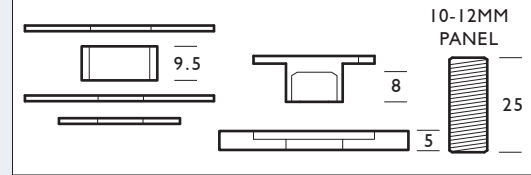

**BODIES:**

Ø32 + Ø50

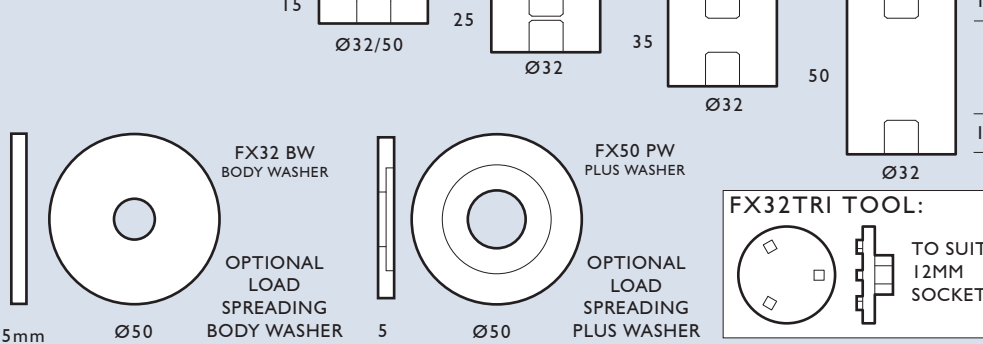

**FASTENERS:**

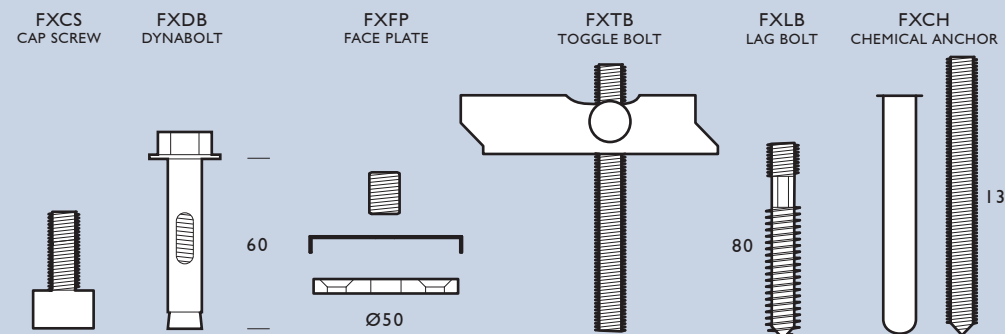

**LOCATIONS:**

Interior and exterior applications

**PANEL THICKNESS:**

Head Pack 10 - 12mm  
Optional studs available - 16, 20, 25, 30, 35, 40, 50mm, custom

**MINIMUM CLEARANCE HOLE:**

With isolating sleeve Ø20  
Without isolating sleeve Ø17

**THREAD:**

Head - M10 x 8mm  
Fastener - M10 x 12mm

**FINISH:**

Satin Stainless Steel

**MATERIAL:**

316 Grade Stainless Steel for exterior applications.

**PRODUCT COMPLIANCY:**

As FIX Systems are not certified engineers, it is the buyer's responsibility to ensure that the application of all FIX products is suitable for its intended use and that it is compliant with relevant safety standards.





32mm DIAMETER STRUCTURAL LOW PROFILE PIN

# FX32 DUO

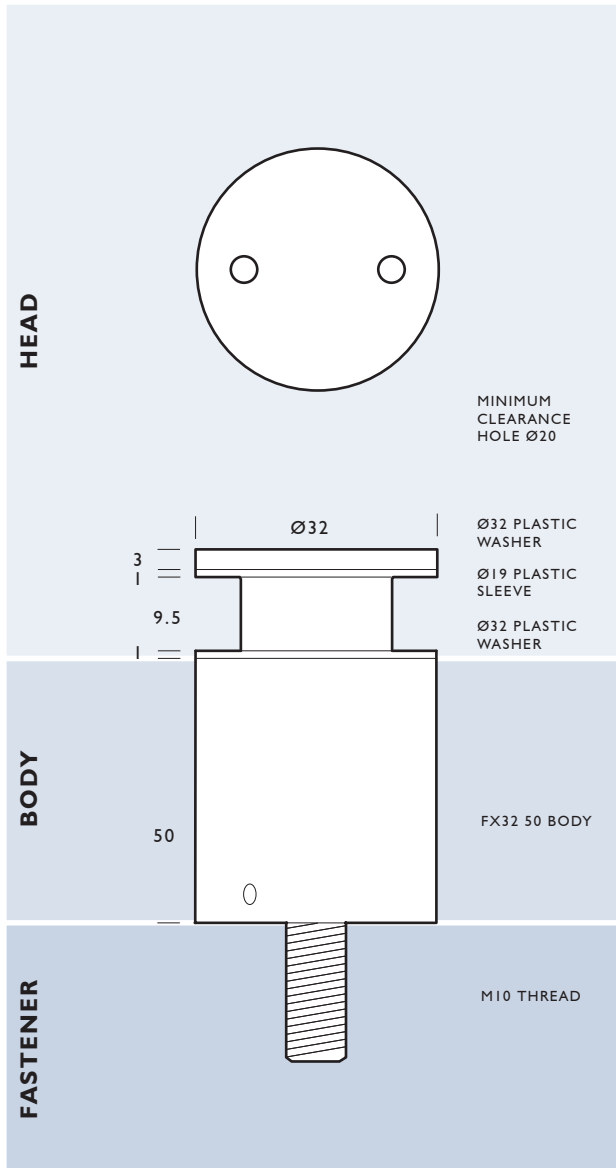

**HEADS:**

FX32 DUO

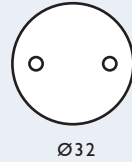

**FX32 DUO HEAD PACK:**

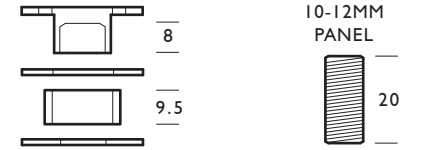

**BODIES:**

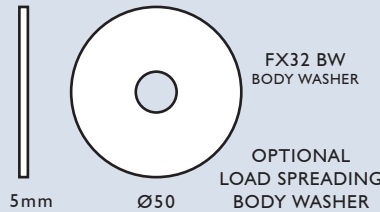
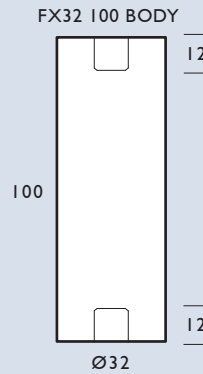
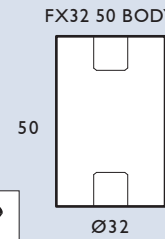
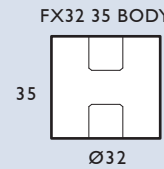
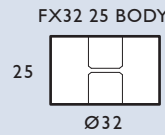
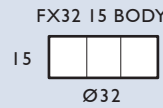

**FX TOOLS:**



**FASTENERS:**

FXCS  
CAP SCREW

FXDB  
DYNABOLT

FXFP  
FACE PLATE

FXTB  
TOGGLE BOLT

FXLB  
LAG BOLT

FXCH  
CHEMICAL ANCHOR

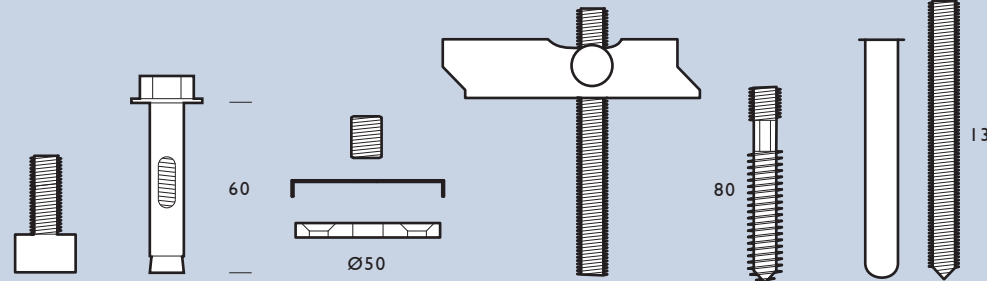

**LOCATIONS:**

Interior and exterior applications

**PANEL THICKNESS:**

Head Pack 10mm - 12mm  
Optional studs available - 16, 20, 25, 30, 35, 40, 50mm

**MINIMUM CLEARANCE HOLE:**

With isolating sleeve Ø20  
Without isolating sleeve Ø17

**THREAD:**

Head - M10 x 8mm  
Fastener - M10 x 12mm

**FINISH:**

Satin Stainless Steel

**MATERIAL:**

316 Grade Stainless Steel

**PRODUCT COMPLIANCY:**

As FIX Systems are not certified engineers, it is the buyer's responsibility to ensure that the application of all FIX products is suitable for its intended use and that it is compliant with relevant safety standards.



32mm DIAMETER STRUCTURAL LOW PROFILE PIN

# FX32 DUO PLUS

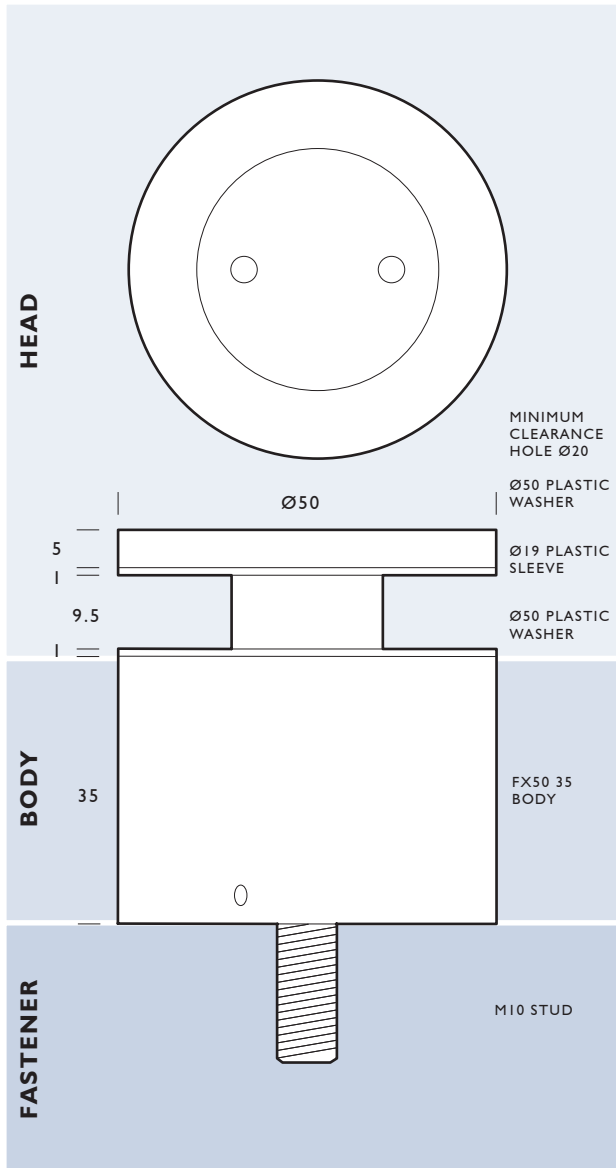

**HEADS:**

FX32 DUO PLUS

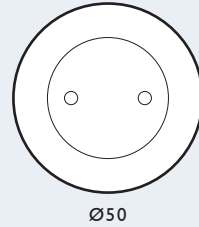

**FX32 DUO PLUS HEAD PACK:**

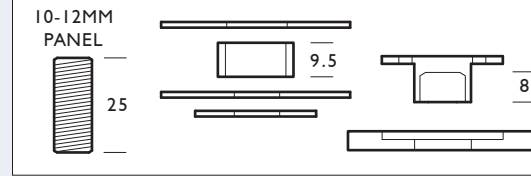

**BODIES:**

Ø32 + Ø50

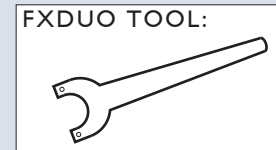
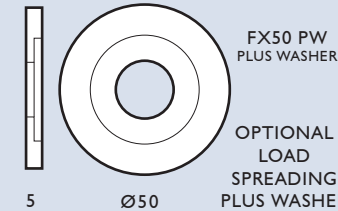
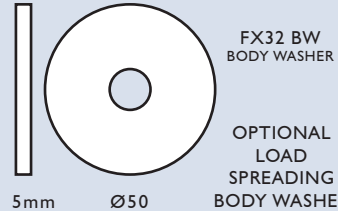
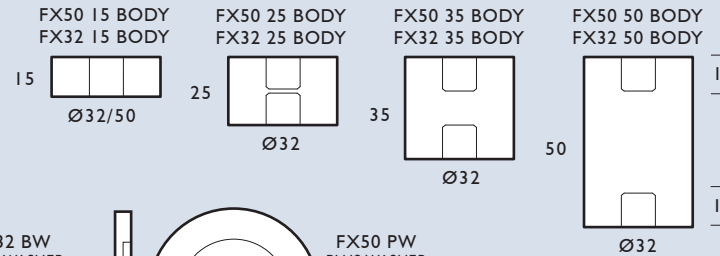

**FASTENERS:** FASTENERS COME WITH COMPATIBLE M10 STUD

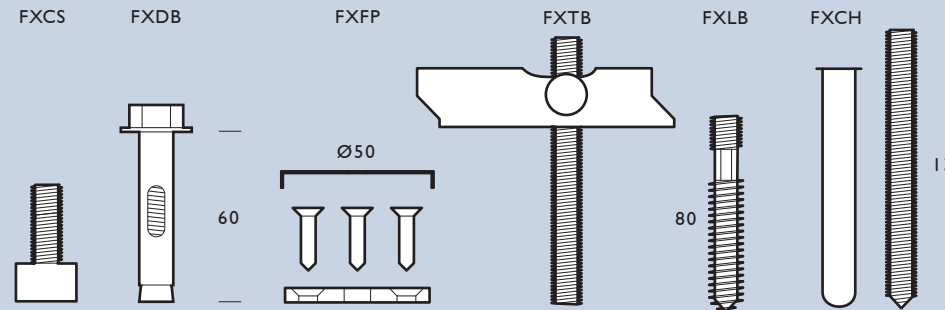

**LOCATIONS:**

Interior and exterior applications

**PANEL THICKNESS:**

Standard Head Pack - 10mm - 12mm  
Optional studs available - 16, 20, 25, 30, 35, 40, 50mm

**MINIMUM CLEARANCE HOLE:**

With isolating sleeve Ø20  
Without isolating sleeve Ø17

**THREAD:**

Head - M10 x 8mm  
Fastener - M10 x 12mm

**FINISH:**

Satin Stainless Steel

**MATERIAL:**

316 Grade Stainless Steel

**PRODUCT COMPLIANCY:**

As FIX Systems are not certified engineers, it is the buyer's responsibility to ensure that the application of all FIX products is suitable for its intended use and that it is compliant with relevant safety standards.



## 50mm DIAMETER STRUCTURAL PIN

# FX50 PIN

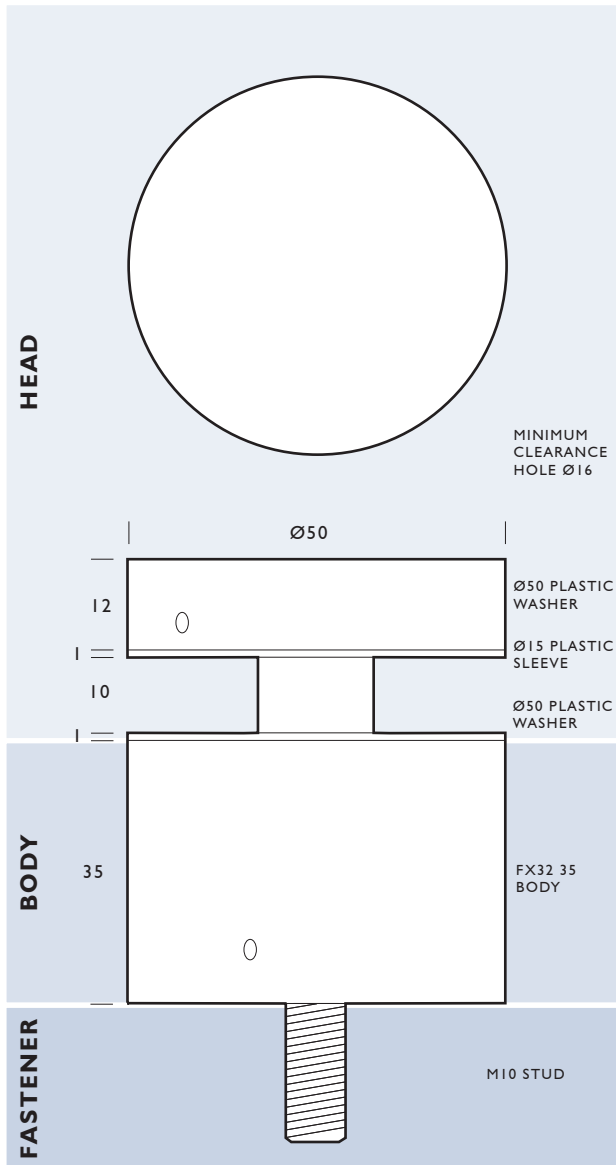

### HEADS:

FX50 HEAD

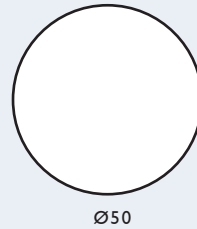

### FX50 HEAD PACK:

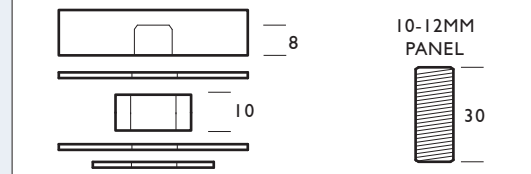

### BODIES:

Ø32 + Ø50

FX50 15 BODY  
FX32 15 BODY



FX50 25 BODY  
FX32 25 BODY

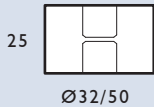

FX50 35 BODY  
FX32 35 BODY

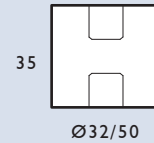

FX50 50 BODY  
FX32 50 BODY

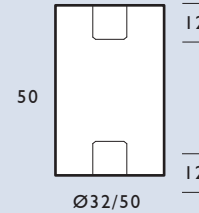

FX32 BW  
BODY WASHER

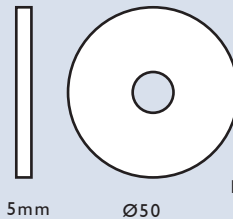

OPTIONAL  
LOAD SPREADING  
BODY WASHER

### FX TOOL:



### FASTENERS:

FXCS  
CAP SCREW

FXDB  
DYNABOLT

FXFP  
FACE PLATE

FXTB  
TOGGLE BOLT

FXLB  
LAG BOLT

FXCH  
CHEMICAL ANCHOR

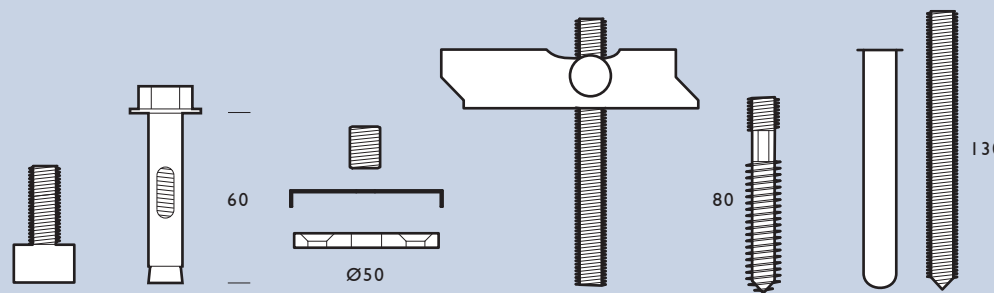

### LOCATIONS:

Interior and exterior applications

### PANEL THICKNESS:

Head Pack 10 - 12mm  
Optional studs available - 16, 20, 25, 30, 35, 40, 50mm

### MINIMUM CLEARANCE HOLE:

With isolating sleeve Ø16  
Without isolating sleeve Ø10.5

### THREAD:

Head - M10 x 8mm  
Fastener - M10 x 12mm

### FINISH:

Satin Stainless Steel

### MATERIAL:

316 Grade Stainless Steel

### PRODUCT COMPLIANCY:

As FIX Systems are not certified engineers, it is the buyer's responsibility to ensure that the application of all FIX products is suitable for its intended use and that it is compliant with relevant safety standards.



50mm DIAMETER STRUCTURAL LOW PROFILE PIN

# FX50 CAP

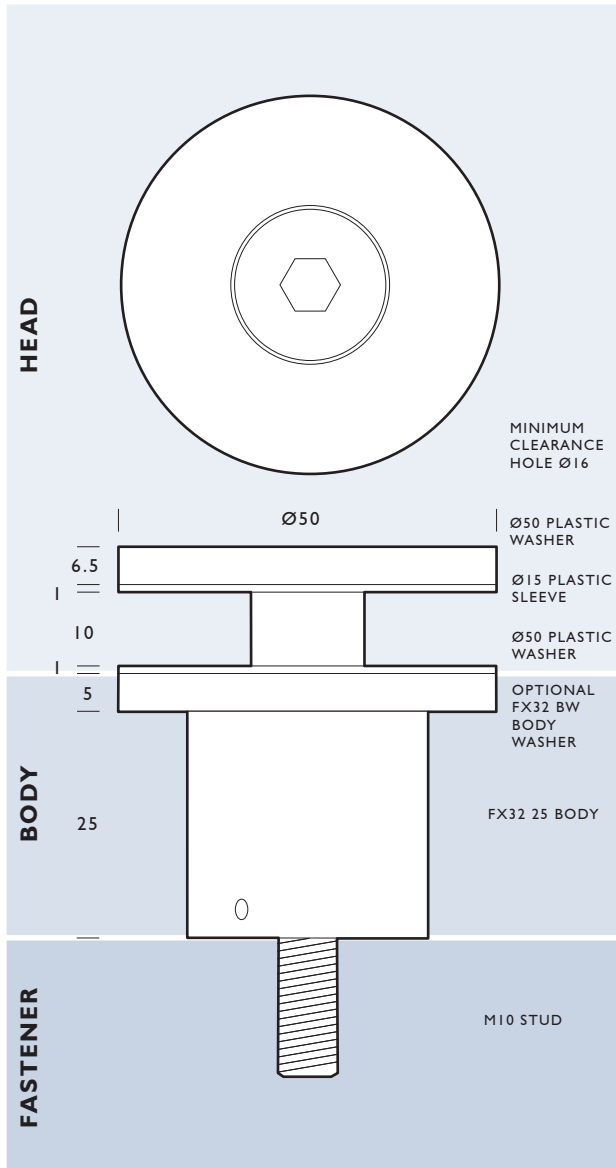

**HEADS:**

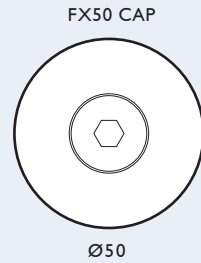

**FX50 CAP HEAD PACK:**

10-12MM PANEL

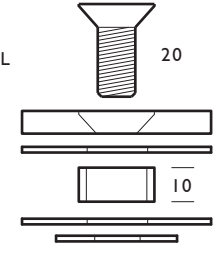

**BODIES:**

Ø32 + Ø50

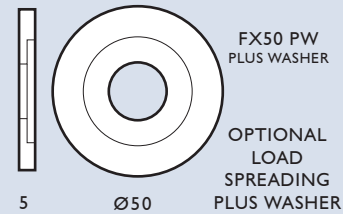
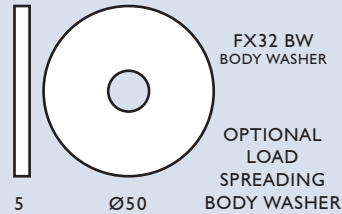
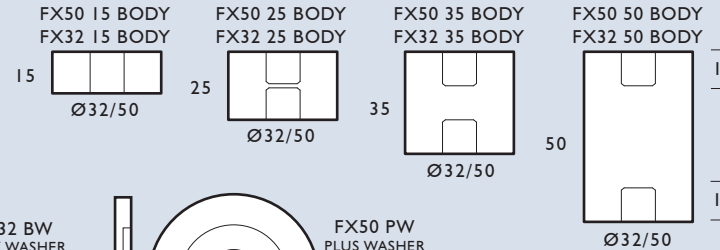

**FASTENERS:**

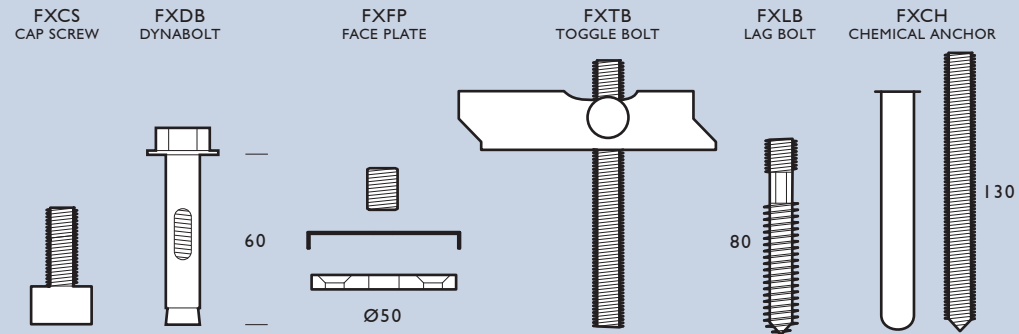

**LOCATIONS:**

Interior and exterior applications

**PANEL THICKNESS:**

Head Pack 10 - 12mm  
Optional M10 Countersunk Cap Screw 20, 25, 30, 35, 40, 50mm

**MINIMUM CLEARANCE HOLE:**

With isolating sleeve Ø16  
Without isolating sleeve Ø10.5

**SCREW:**

Countersunk M10 Cap Screw

**FINISH:**

Satin Stainless Steel

**MATERIAL:**

316 Grade Stainless Steel

**PRODUCT COMPLIANCY:**

As FIX Systems are not certified engineers, it is the buyer's responsibility to ensure that the application of all FIX products is suitable for its intended use and that it is compliant with relevant safety standards.



# BALUSTRADING

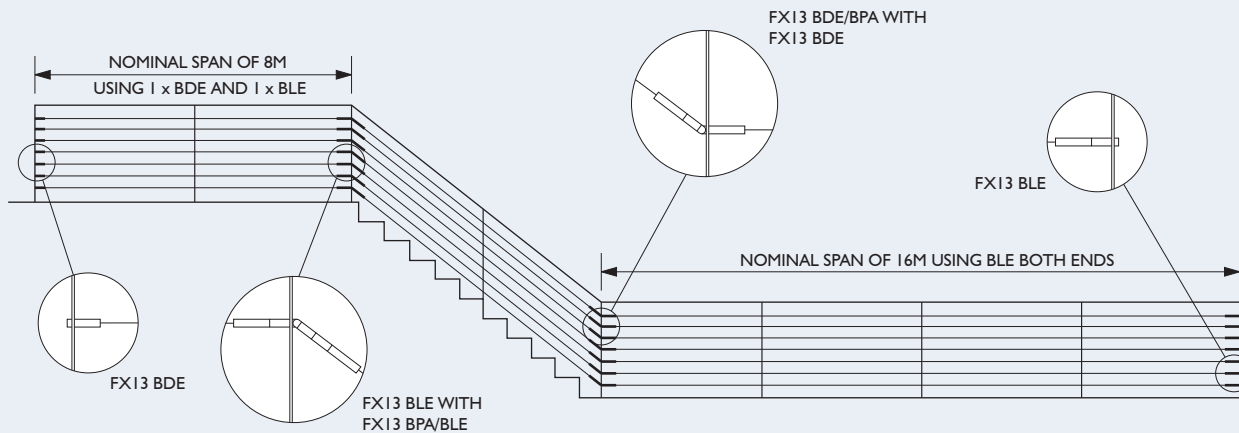

## SPANS:

For each FX13BLE a nominal span of 8m can be achieved, for spans between 8m and 16m an FX13BLE fitting is required at both ends. For spans greater than 16m, components can be mounted back to back.

## BUILDING CODES:

Please ensure that your balustrade layout conforms to appropriate building standards.

## FX13CBL:

Balustrade Cable

The FIX balustrade system requires the use of 1/8" dia. 7 x 7 strand 316 grade stainless wire.

## SWAGING:

For on site balustrade installation, a Swaging Tool #8 and wire-cutters are required.

## FASTENING:

As an alternative to FX BALUSTRADE HEAD, it is also possible to use FIX's range of M10 PIN Head options, FX M10 FACE PLATE, or any of our M10 fasteners as balustrade fasteners.

FLAT BAR WITH FX BALUSTRADE HEAD

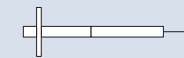

MASONRY WALL WITH M10 DYNABOLT

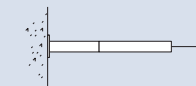

TUBE WITH FX BALUSTRADE HEAD (BLE RECESSED INTO TUBE)

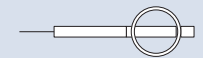

RHS WITH M10 NUTSERTS

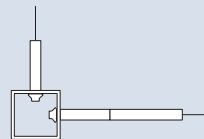

TIMBER WITH FACE PLATE

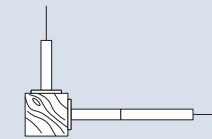

RHS WITH FX BALUSTRADE HEAD (BLE RECESSED INTO TUBE)



ANGLE WITH M10 SOCKET HEAD CAP SCREW

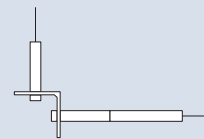

BACK - TO - BACK

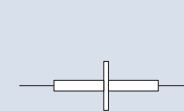

TUBE WITH M10 WELDED STUDS

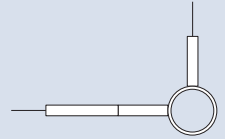

13mm DIAMETER BALUSTRADE LIVE END

# FXI3 BLE

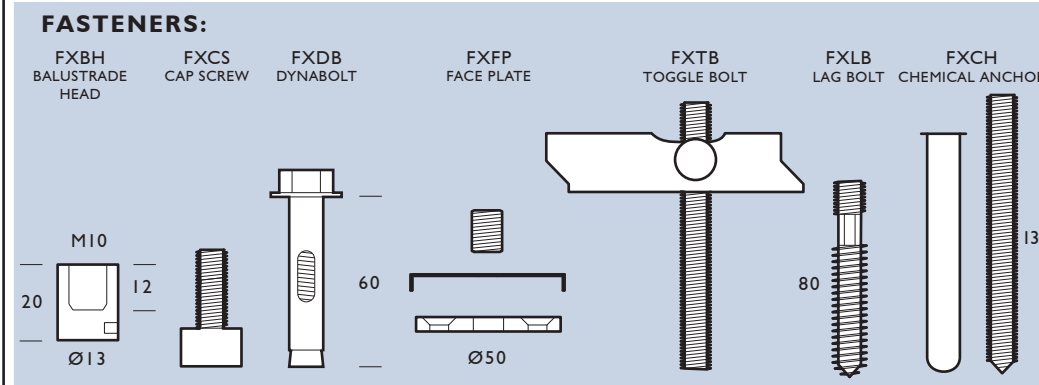
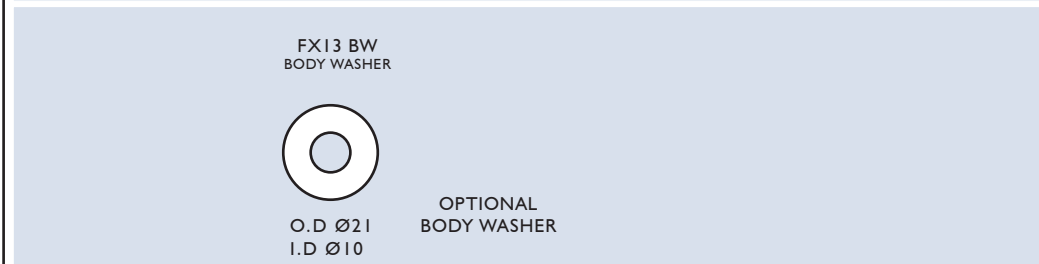
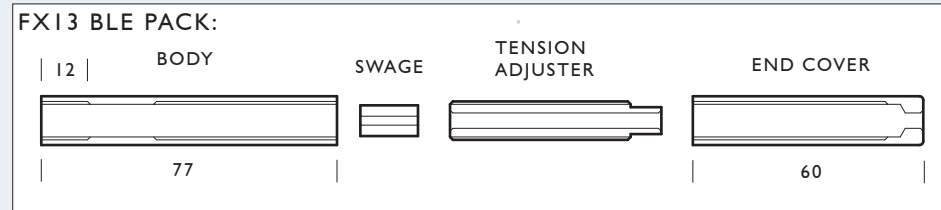
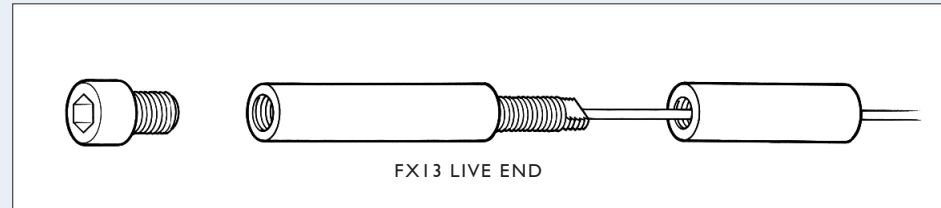
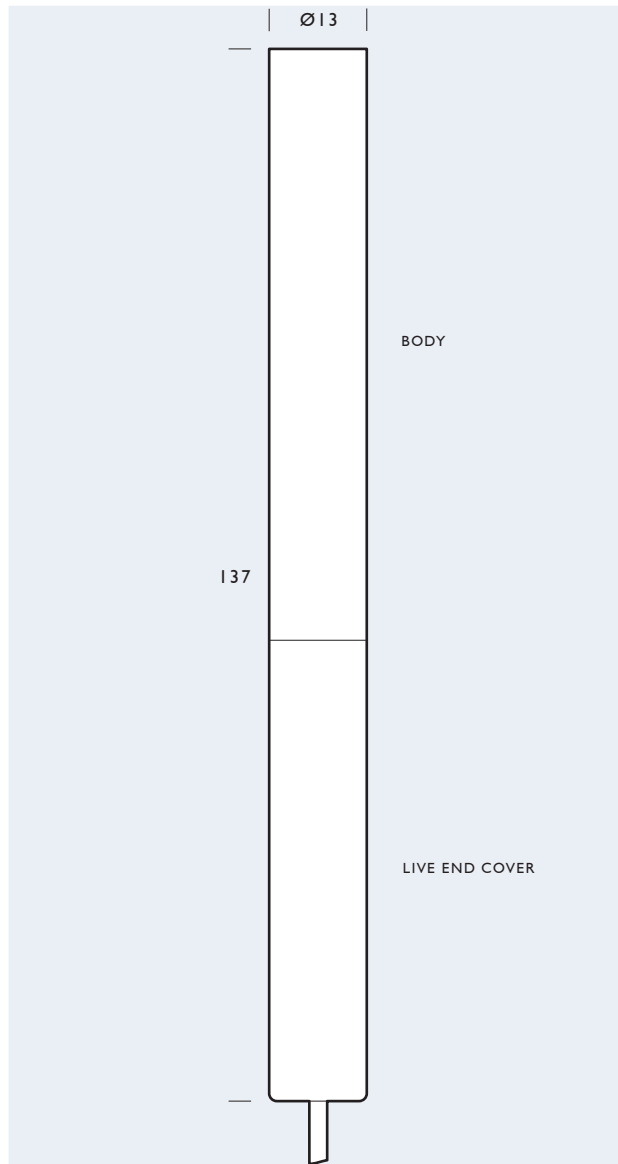

**FXI3BLE:**

- Balustrade Live End
- Tensionable fixing, maximum adjustment 45mm
- For each FXI3BLE a nominal span of 8m can be achieved, for spans between 8m and 16m an FXI3BLE is required at both ends
- For spans greater than 16m, components can be mounted back to back

**LOCATION :**

Interior and exterior applications

**THREAD:**

M10

**FINISH:**

Satin Stainless Steel

**MATERIAL:**

316 grade Stainless Steel

**FXI3CBL:**

Balustrade Cable  
- 7 X 7 strand, Ø1/8" 316 Grade stainless steel cable

**PRODUCT COMPLIANCY:**

As FIX Systems are not certified engineers, it is the buyer's responsibility to ensure that the application of all FIX products is suitable for its intended use and that it is compliant with relevant safety standards.



# 13mm DIAMETER BALUSTRADE DEAD END

# FXI 3 BDE

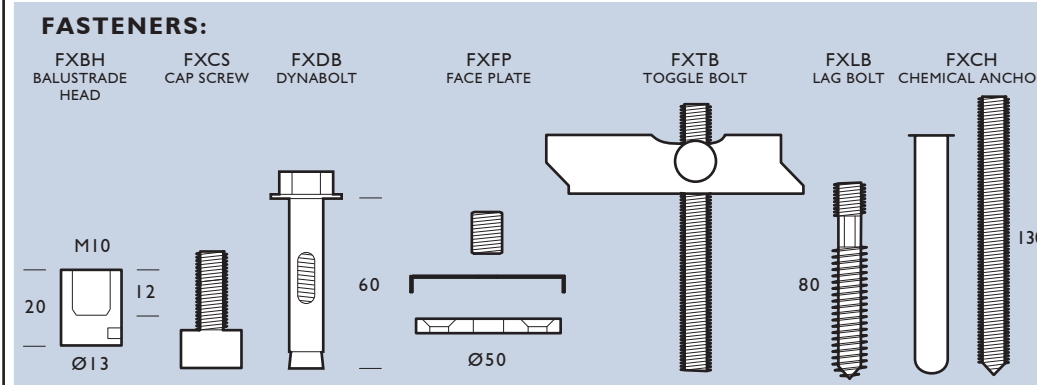
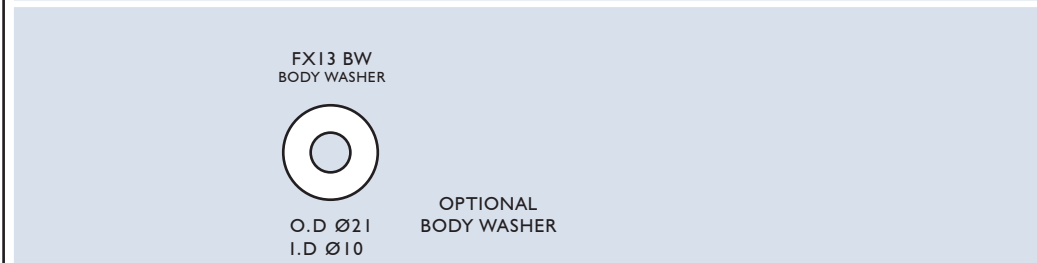
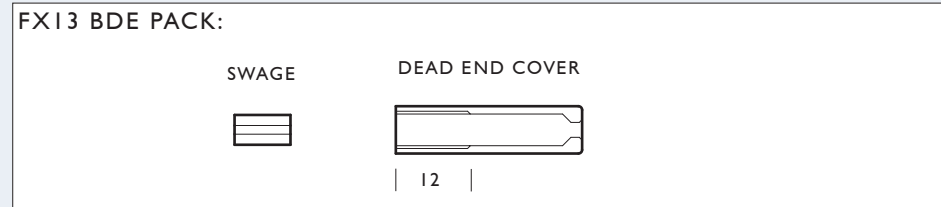
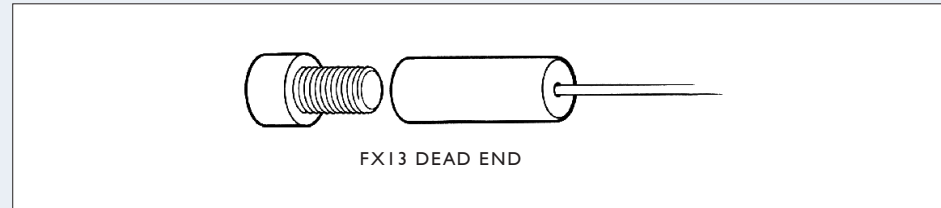
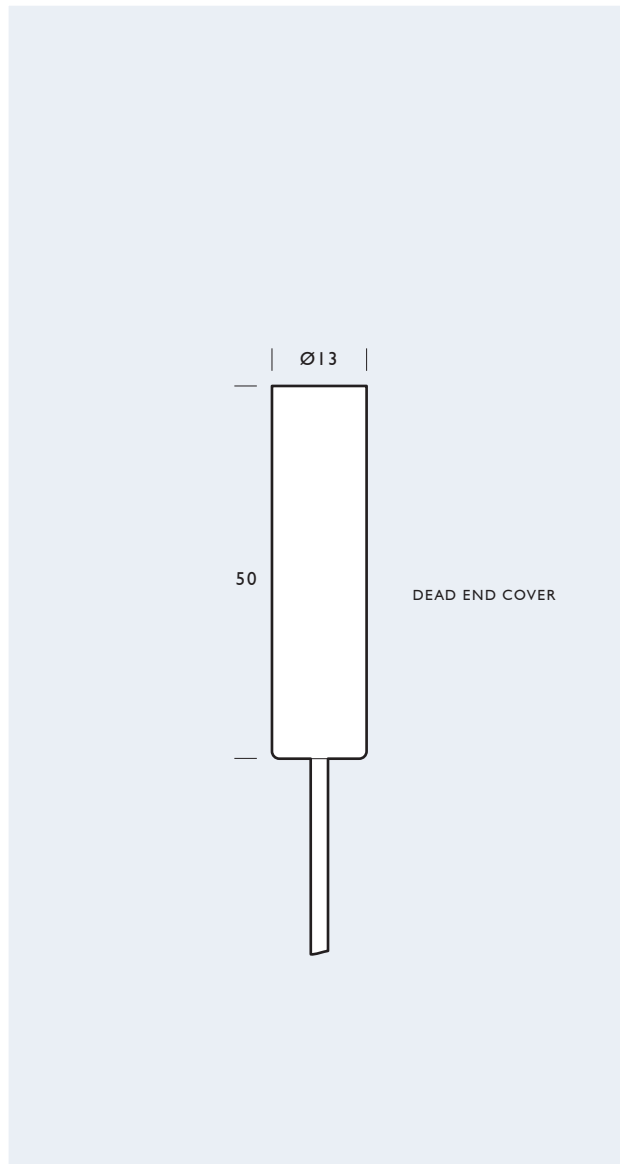

**FXI3BDE:**

Balustrade Dead End  
Stationary non adjustable fixing

**LOCATION:**

Interior and exterior applications

**THREAD:**

M10

**FINISH:**

Satin Stainless Steel

**MATERIAL:**

316 grade Stainless Steel

**FXI3CBL:**

Balustrade Cable  
-7 X 7 strand, Ø1/8" 316 Grade stainless steel cable

**PRODUCT COMPLIANCY:**

As FIX Systems are not certified engineers, it is the buyer's responsibility to ensure that the application of all FIX products is suitable for its intended use and that it is compliant with relevant safety standards.



## 13mm DIAMETER BALUSTRADE PIVOT ASSEMBLY

# FXI3 BPA

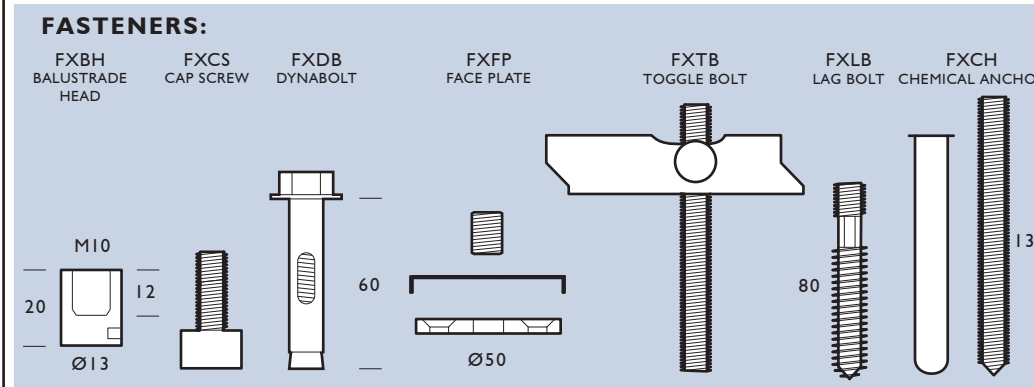
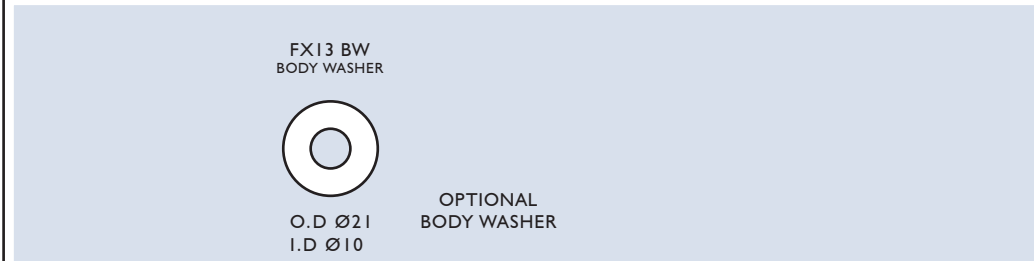
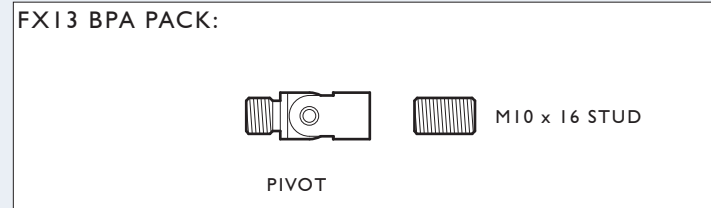
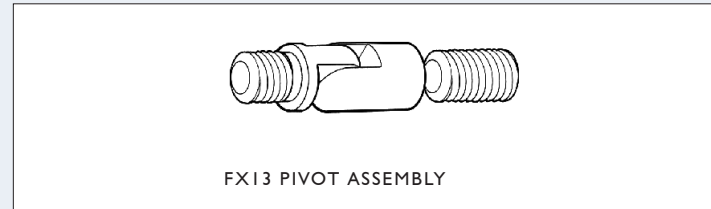
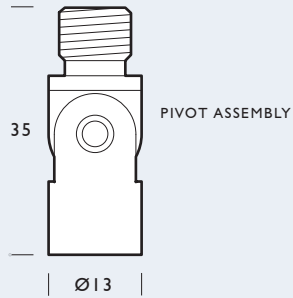

### FX13BPA:

- Balustrade Pivot Assembly
- The FX13BPA is a swinging pivot for fixing cables at any angle required
  - The FX13 BPA can only be used in conjunction with an FX13BDE or FX13BLE

### LOCATION :

Interior and exterior applications

### THREAD:

M10

### FINISH:

Satin Stainless Steel

### MATERIAL:

316 grade Stainless Steel

### FX13CBL:

Balustrade Cable  
- 7 x 7 strand, Ø1/8" 316 grade stainless steel cable

### PRODUCT COMPLIANCY:

As FIX Systems are not certified engineers, it is the buyer's responsibility to ensure that the application of all FIX products is suitable for its intended use and that it is compliant with relevant safety standards.





50mm DIAMETER FACE PLATE

# FXFP 1/4"

FACE PLATE

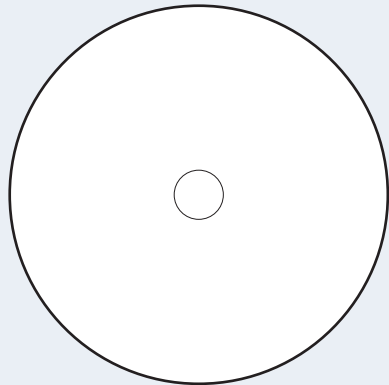

Ø50

1/4" B.S.W  
STUD /  
ALLTHREAD

6

COVER PLATE

SCREWS

FASTENER

**FACE PLATE:**

**FACEPLATE 1/4" W PACK:**

1/4" B.S.W  
STUD /  
ALLTHREAD



12

COVER PLATE 6

FIXING PLATE 5

**APPLICATIONS:**

FX12 20 BODY

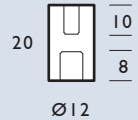

Ø12

FX12 30 BODY



Ø12

M4

1/4" BSW

FX19 20 BODY

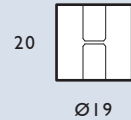

Ø19

FX19 30 BODY

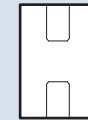

Ø19

FX19 50 BODY

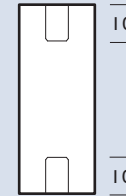

Ø19

FX25 20 BODY

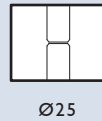

Ø25

FX25 30 BODY

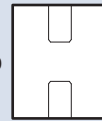

Ø25

FX25 50 BODY

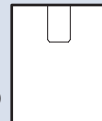

Ø25

FX25 75 BODY

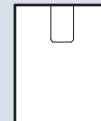

Ø25

FX25 100 BODY

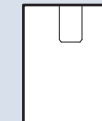

Ø25

**LOCATIONS:**

Interior and exterior applications

**THREAD:**

1/4" B.S.W

**FINISH:**

Satin Stainless Steel

**MATERIAL:**

Zinc plated - mounting plate  
304 grade stainless steel - cover plate

**PRODUCT COMPLIANCY:**

As FIX Systems are not certified engineers, it is the buyer's responsibility to ensure that the application of all FIX products is suitable for its intended use and that it is compliant with relevant safety standards.



# 50mm DIAMETER FACE PLATE

# FXFP M10

FACE PLATE

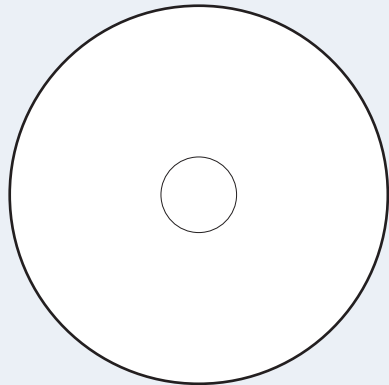

Ø50

M10 STUD

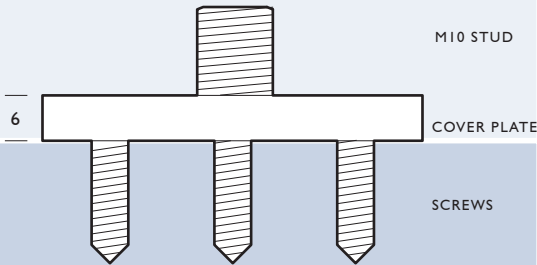

COVER PLATE

SCREWS

FASTENER

## FACE PLATE:

FACEPLATE M10 PACK:

M10 STUD / ALLTHREAD



16

COVER PLATE



6

FIXING PLATE



5

## APPLICATIONS:

FX13 BLE

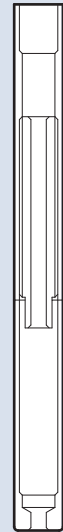

LIVE END

FX13 BDE

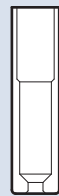

DEAD END

FX13 BPA



PIVOT ASSEMBLY

FX16 HRB  
FX HANDRAIL BRACKET

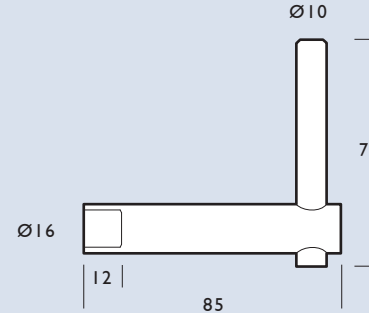

FX50 15 BODY  
FX32 15 BODY

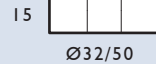

Ø32/50

FX50 25 BODY  
FX32 25 BODY



Ø32/50

FX50 35 BODY  
FX32 35 BODY



Ø32/50

FX50 50 BODY  
FX32 50 BODY

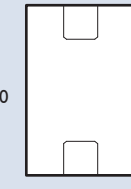

Ø32/50

## LOCATIONS:

Interior and exterior applications

## THREAD:

M10

## FINISH:

Satin Stainless Steel

## MATERIAL:

Zinc plated - mounting plate  
304 grade stainless steel - cover plate

## PRODUCT COMPLIANCY:

As FIX Systems are not certified engineers, it is the buyer's responsibility to ensure that the application of all FIX products is suitable for its intended use and that it is compliant with relevant safety standards.



# FASTENERS

## 1/4" FASTENERS:

FASTENERS COME WITH COMPATIBLE 1/4" BSW STUD



**FXNW**  
NUT AND WASHER  
STUD  
M.C.H Ø7

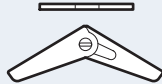

**FXST**  
SPRING TOGGLE  
M.C.H Ø17



**FXTI**  
THREADED INSERT  
PILOT Ø8

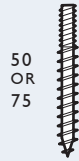

**FXLB (1/4")**  
LAG BOLT  
PILOT Ø4

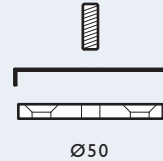

**FXFP (1/4")**  
FACE PLATE  
1/4 B.S.W

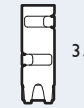

**FXMA**  
MASONRY ANCHOR  
M.C.H Ø13



**FXCA**  
CAVITY ANCHOR  
M.C.H Ø12

## M10 FASTENERS:

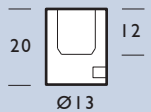

**FXBH**  
BALUSTRADE HEAD  
M10  
(316g)

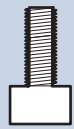

**FXCS**  
CAP SCREW  
M.C.H Ø10.5  
(VARIOUS  
LENGTHS  
AVAILABLE)

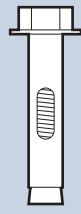

**FXDB**  
DYNABOLT  
M.C.H Ø13

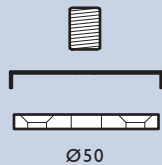

**FXFP (M10)**  
FACE PLATE  
M10

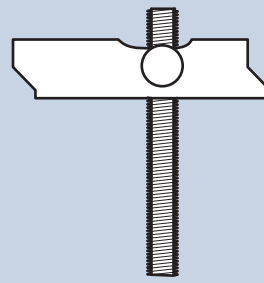

**FXTB**  
TOGGLE BOLT  
M.C.H Ø23

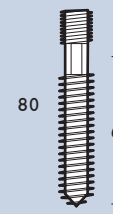

**FXLB (M10)**  
LAG BOLT  
PILOT Ø8

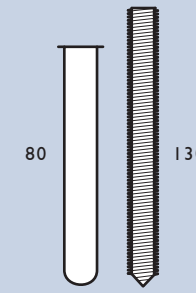

**FXCH**  
CHEMICAL ANCHOR  
M.C.H Ø12

## 1/4" WHITWORTH THREADED STUDS AVAILABLE:

- LENGTH 12MM
- LENGTH 16MM
- LENGTH 19MM
- LENGTH 22MM
- LENGTH 25MM
- LENGTH 27MM
- LENGTH 29MM
- LENGTH 32MM
- LENGTH 38MM
- LENGTH 51MM
- LENGTH 75MM
- LENGTH 100MM

## M10 THREADED STUDS AVAILABLE:

- LENGTH 16MM
- LENGTH 20MM
- LENGTH 25MM
- LENGTH 30MM
- LENGTH 35MM
- LENGTH 40MM
- LENGTH 50MM
- CUSTOM LENGTH

\* **M.C.H** =  
MINIMUM CLEARANCE HOLE

\* **PILOT** =  
PILOT DRILL SIZE

## PRODUCT COMPLIANCY:

As FIX Systems are not certified engineers, it is the buyer's responsibility to ensure that the application of all FIX products is suitable for its intended use and that it is compliant with relevant safety standards.

