

buy the original and buy the best

[www.hunterpacific.com.au](http://www.hunterpacific.com.au)

**FEATURES >>**



SEVEN SELECTABLE SPEEDS  
FOR SUMMER (FORWARD)  
OR WINTER (REVERSE) USE



REVERSIBLE AIRFLOW FROM  
SUPPLIED REMOTE CONTROL



USER SERVICEABLE



IP44 WEATHER RATED



INNOVATIVE, SLIM & POWERFUL  
AC INDUCTION MOTOR

White



Matt Black



Brushed Aluminium



**REVOLUTION**  
CEILING FAN

### SIDE VIEW

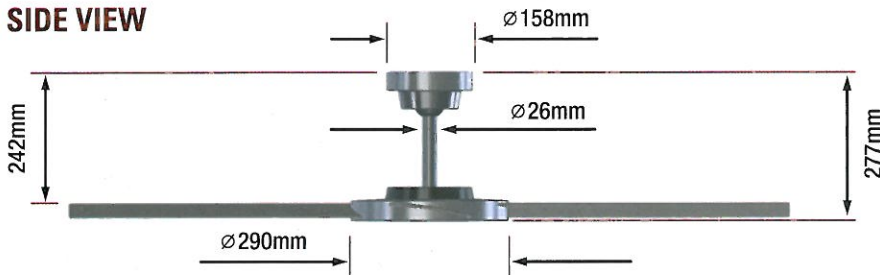

### BOTTOM VIEW

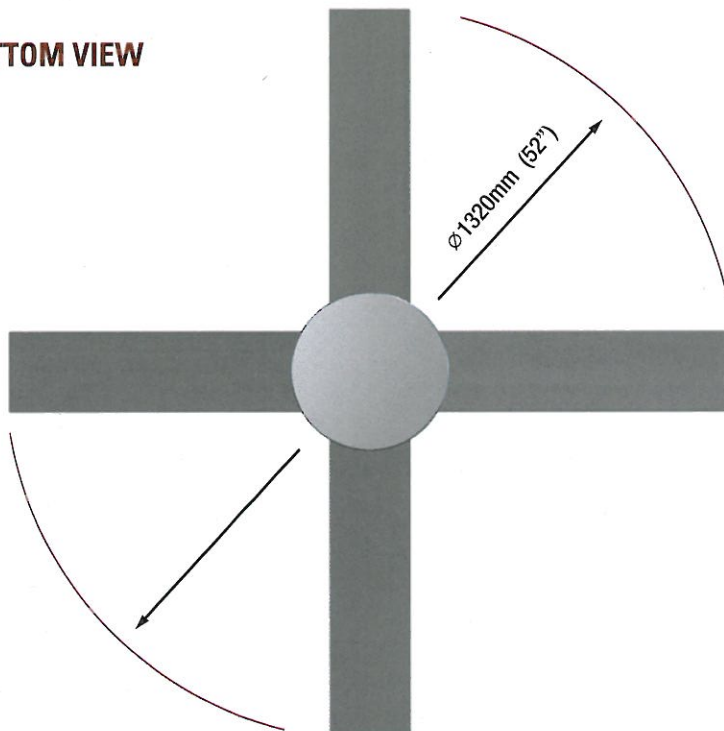

















### ABOUT REVOLUTION:

*Revolution is an entirely new design and not just on the surface. Using new techniques (patents pending) developed by Hunter Pacific International in Australia, it is now possible to make slim, elegant motors for ceiling fans and this opens the way for new shapes never before possible.*

*Advanced aerodynamic blades and electronic control means the Revolution is at the cutting edge of ceiling fan efficiency, drawing only 48 Watts on high speed while moving more air than similar size fans that are thicker in size and heavier. When operating to supplement other cooling and heating devices this fan consumes as little as 5W when running on the lowest speed setting.*

*Clever engineering allows the Revolution to have its major parts removed and replaced without requiring an electrician in most States of Australia, allowing faster turnaround time and reducing service costs.*

## Product Features:

-  Safe, quiet polymer blades
-  Reversible airflow from remote
-  Not light adaptable
-  7 selectable speeds for Summer (forward) or Winter (reverse) use
-  Angled ceiling mount (up to 38°)
-  Robust die-cast aluminium body and canopy
-  Innovative, slim & powerful AC induction motor
-  Eco-friendly, Low Power Consumption Product
-  2 years 'in-home' warranty on non-user replaceable parts. 5 years warranty on user replaceable parts (excluding blades, cosmetic issues and surge damage – other exclusions apply).
-  User serviceable (see instruction manual in regards to which components can & cannot be serviced by the customer)
-  Suitable for use with Building Automation Systems (when using additional (accessory) interface)
-  High efficiency aerofoil blade design
-  Coastal/Indoor/Outdoor undercover use
-  IP44 rating
-  52" (1320mm) blade sweep
-  Threaded downrod



# REVOLUTION CEILING FAN

SPECIFICATIONS SUBJECT TO CHANGE.  
REFER TO [www.hunterpacific.com.au](http://www.hunterpacific.com.au) FOR FULL PRODUCT SPECIFICATIONS

DISTRIBUTED BY:



# HUNTER PACIFIC INTERNATIONAL

## *Ceiling Fans*

buy the original and buy the best

[www.hunterpacific.com.au](http://www.hunterpacific.com.au)



# Attitude

## CEILING FAN

### FEATURES:



SEVEN SELECTABLE SPEEDS FOR SUMMER (FORWARD) OR WINTER (REVERSE) USE



REVERSIBLE AIRFLOW FROM SUPPLIED REMOTE CONTROL



USER SERVICEABLE



IP44 WEATHER RATED



INNOVATIVE, SLIM & POWERFUL AC INDUCTION MOTOR

### FAN COLOURS

White



Matt Black



Brushed Aluminium



**SIDE VIEW**

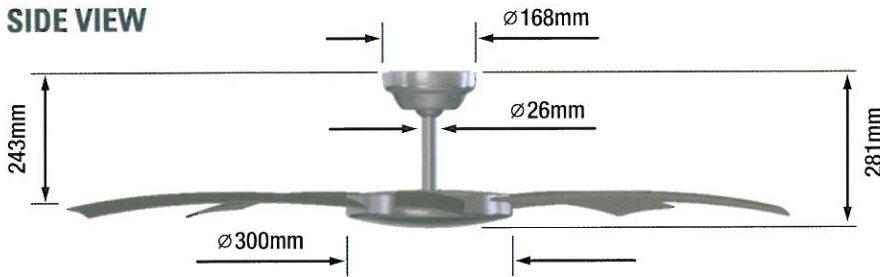

**BOTTOM VIEW**

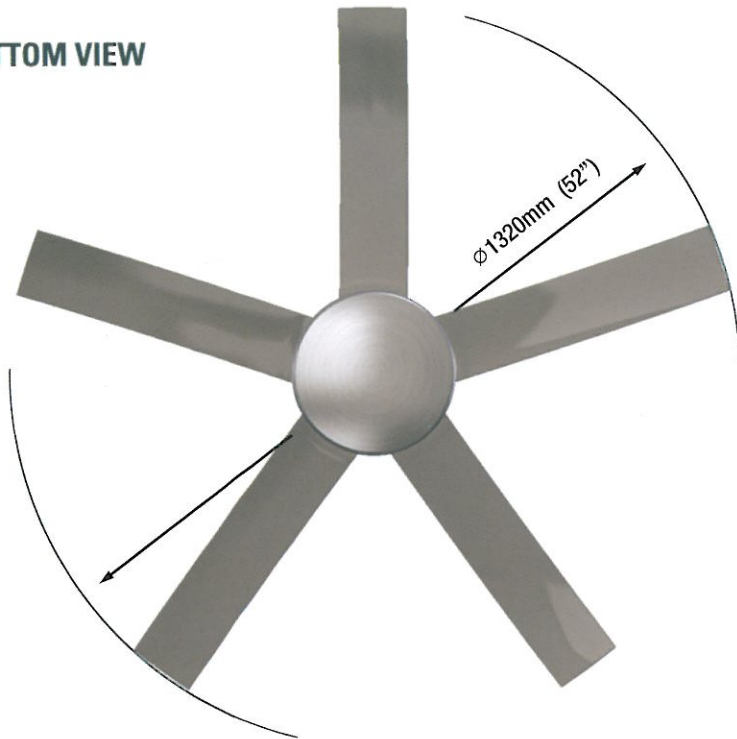

**ABOUT ATTITUDE:**

*Attitude is an entirely new design and not just on the surface. Using new techniques (patents pending) developed by Hunter Pacific International in Australia, it is now possible to make slim, elegant motors for ceiling fans and this opens the way for new shapes never before possible.*

*Advanced aerodynamic blades and electronic control means the Attitude is at the cutting edge of ceiling fan efficiency, drawing only 48 Watts on high speed while moving more air than similar size fans that are thicker in size and heavier. When operating to supplement other cooling and heating devices this fan consumes as little as 5W when running on the lowest speed setting.*

*Clever engineering allows the Attitude to have its major parts removed and replaced without requiring an electrician in most States of Australia, allowing faster turnaround time and reducing service costs.*

**Product Features:**

- Safe, quiet polymer blades
- Reversible airflow from remote
- Not light adaptable
- 7 selectable speeds for Summer (forward) or Winter (reverse) use
- Angled ceiling mount (up to 38°)
- Robust die-cast aluminium body and canopy
- Innovative, slim & powerful AC induction motor
- Eco-friendly, Low Power Consumption Product
- 2 years 'in-home' warranty on non-user replaceable parts. 5 years warranty on user replaceable parts (excluding blades, cosmetic issues and surge damage – other exclusions apply).
- User serviceable (see instruction manual in regards to which components can & cannot be serviced by the customer)
- Suitable for use with Building Automation Systems (when using additional (accessory) interface)
- High efficiency aerofoil blade design
- Coastal/Indoor/Outdoor undercover use
- IP44 rating
- 52" (1320mm) blade sweep
- Threaded downrod



DISTRIBUTED BY: